



Competing at the edge of change

The new standard for fluid conveyance



Powering Business Worldwide

There's a spirited energy at Eaton.

It comes from the alignment of some of the most respected names in fluid power to build a brand you can trust to meet the world's demand for high-efficiency hydraulic systems.

Our goal is simple: To provide unique fluid power solutions across a range of mobile and stationary markets that keep businesses competing at the leading edge of change.

So, why partner with Eaton?

After all, we know you have choices. You partner with Eaton because every aspect of our business is focused on ensuring your continued success:

- Focused manufacturing that anticipates the needs of a global business environment
- Streamlined product commercialization that deploys tested and qualified products that meet or exceed industry standards
- Product features and attributes that deliver improved performance at a good value
- Safety is treated as a priority within our culture, and yours. Crimp with confidence knowing that Eaton pairs its hoses and fittings after rigorous qualification and testing procedures
- Dedicated people, who focus daily on meeting your needs
- Engaging marketing and sales programs designed to educate and enable growth in partnership with Eaton

Weatherhead core hydraulic products

Hose products

Our new core premium hoses for OEM or aftermarket use exceed industry standards for pressure, temperature and abrasion resistance, with options adapted to handle your toughest jobs. Look for Diamond Advantage hoses for the highest pressure and temperature ratings to extend the life of your hose. Available in braided and spiral hose constructions.



 Look for the Diamond Advantage

Specialty hose

NG-TW hose
35NG hose

Certified by:



Fittings



Z-Series

One-piece "Bite-the-wire" style hose fitting that is qualified with virtually Weatherhead™ one and two wire braided hydraulic hoses, and features DuraKote™ plating technology.



4S/6S Spiral Series

A higher performing spiral hose assembly for the most demanding applications while using a simple more user-friendly hose and hose fitting assembly process, featuring DuraKote plating technology.

Tooling

ET1187 Portable Variable Crimp Machine

Eaton ET1187 crimp machine with the micrometer feature: It's as simple as turning the collar to the correct color to match the layline on the hose.

- Color-coded collar matches core hose layline for easy set-up
- 'Z' fittings and applicable hoses in sizes 1/4" through 1-1/4"
- 4S fittings and applicable hoses in sizes 3/4" through 1"



Weatherhead provides confidence in hose assembly, corrosion and leakage protection.

Engineered assemblies

Eaton's Weatherhead hoses and fittings are engineered and qualified to work as a system ensuring your confidence in a high quality hose assembly. The 4-Step **WeatherMATCH™** system for braided and spiral hose assemblies ensure proper mating of hose and qualified fittings.

4 Step Hose Identification System

Braided Hose Assembly

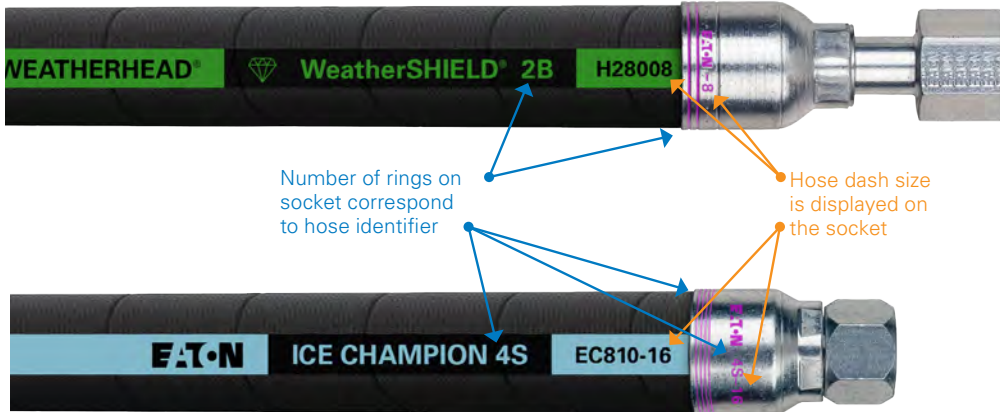

DURA-KOTE™ plating technology

Hose fittings that will now offer 3x the corrosion protection on carbon steel fittings as compared to competitive hose fittings. Eaton's DURA-KOTE fittings provide up to 1000 hours of corrosion protection. This is a huge step forward in metal fitting corrosion protection.

3X Carbon Steel Corrosion Protection



Corrosion of current carbon steel adapters after 650 hours of exposure to salt spray testing.

DURA-SEAL™ technology

This patent-pending innovation from Eaton eliminates hose assembly cool-down leakage, while extending hose assembly life, reducing equipment down-time.

Class 0 Cool-Down Leakage Protection



4S/6S Fitting



Table of Contents

A	APPLICATION DATA
B	HYDRAULIC HOSE
C	GENERAL PURPOSE HOSE
D	INDUSTRIAL HOSE
E	AIR CONDITIONING AND REFRIGERATION
F	TRANSPORTATION
G	TEFLON HOSE
H	CRIMP FITTINGS
I	REUSABLE AND FIELD ATTACHABLE FITTINGS
J	ADAPTERS
K	ACCESSORIES
L	ASSEMBLY EQUIPMENT
M	INDEX

Hose products

Hose fittings

TABLE OF CONTENTS

Application data	Section A
Safety information	A-2
Hose selection	
Installation and maintenance	A-3
How to order	A-5
Numbering system	
Hose	A-6
Hose Fittings	A-7
Hose Fittings: Quick Identification chart	A-8
Hose Selection chart	A-10
Flow rate	A-22
Pressure charts	A-24
Fluid compatibility	A-26
Hydraulic fluids & lubricating oils	A-32
Hose routing and installation	A-36
Analyzing failures	A-37
Fluid connector	
Fluid connectors identification	A-40
Thread size chart	A-41
Proper tube installation	A-42
Maximum operating pressure	A-43
Recommended wall thickness	A-44
Hydraulic tubing material specifications	A-44
How to measure non-threaded connections	A-45
American connections	A-46
ISO connections	A-49
German connections	A-50
French connections	A-53
British connections	A-53
Japanese connections	A-54
O-Ring pilot thread sizes	A-57
Thread engagement	A-58
Metric thread dimensions	A-59
Assembly torque	A-60
Assembly Instructions ORS, SAE 37° Flare & Pipe	A-61
Tubing selection	
Tubing type and tubing size	A-62
Flow / Velocity chart	A-63
Recommended wall thickness	A-65

TABLE OF CONTENTS (Continued)

Hose			
Hydraulic hose	Section B		
General purpose hose	Section C		
Industrial hose	Section D		
Air conditioning and refrigeration	Section E		
Transportation hose	Section F		
Teflon hose	Section G		
Hose fittings			
Crimp fittings		Section H	
'E' series	H-2		
069 'E' series	H-9		
327 'E' series	H-13		
757 'E' series	H-15		
057 'P' series	H-23		
229 'P' series	H-24		
265 'P' series	H-25		
338 'P' series	H-26		
'Z' series	H-29		
Spiral hose fittings (4S/6S)	H-55		
Everflex hose ends			
Conv-O-Crimp	H-91		
Everswage	H-93		
Field attachable and reusable fittings		Section I	
Braided hose - 1R series	I-2		
Spiral hose - 2R series	I-5		
009 'B' series	I-8		
057 'B' series	I-9		
100 'B' series	I-11		
105 'B' series	I-14		
338 'B' series	I-15		
069 'D' series	I-18		
213 'N' series	I-20		
247 'N' series	I-23		
FC800 Evercool	I-28		
E-Z Clip system	I-31		
Adapters			Section J
Application data			J-2
How to order adapters			J-27
Adapters Configuration index			J-29
ORS connections			J-39
SAE O-Ring boss/SAE O-Ring boss			J-58
Pipe to pipe			J-61
Pipe to SAE 37° flare			J-77
Pipe to 45° flare			J-89
Pipe to SAE O-Ring boss			J-91
Pipe to braze and weld			J-94
SAE 37° flare union			J-94
SAE 45° flare union			J-103
SAE O-Ring boss to SAE 37° flare			J-104
Split flange O-Ring and kits			J-109
SAE flareless to SAE 37° union			J-120
Braze and weld to split flange			J-121
Braze and weld to SAE 37° flare			J-123
Versil-Flare™ – flareless and flared			J-124
Specials			J-128
Metric thread dimensions			J-130
Metric to SAE 37° flare			J-131
ORS to metric			J-134
Pipe to metric			J-135
BSPP to SAE 37° flare			J-136
BSPT to SAE 37° flare			J-137
JIS 30° to SAE 37° flare			J-138
7000 series Ermeto			J-139
Cross reference index			J-153
Accessories			Section K
Protective guards and sleeves			K-2
Accessories to hose chart			K-7
Ready-made hose assemblies			K-16
Hose assembly			K-22
Hose protection			K-23
Hose clamps			K-28
Assembly equipment			Section L
Hose assembly machines and tooling			L-2
Repair and replacement items			L-22
Hose preparation			L-32
Contamination control products			L-40
Cabinets and assortments			L-57
Glossary and Index			Section M
Glossary			M-2
Index			M-6

Eaton Hydraulics' POWERSOURCE®



**Anytime. Anywhere.
Any device.**

Eaton's single-site digital customer experience empowers buyers and sellers of Eaton Hydraulic products across the globe in several languages. The power of **PowerSource** is now available to all users for optimal viewing – on any device, with one click:

www.EatonPowerSource.com

Teflon is a trademark of The Chemours Company FC, LLC used under license by Eaton.

Introduction to Weatherhead

Weatherhead™ products, which became part of Eaton's hydraulics business in 2002, have one of the industry's broadest offerings of hydraulic hose, hose fittings, assembly equipment, tube fittings, couplings and support accessories. Weatherhead products are widely used in industrial and mobile fluid power and fluid conveyance applications. Eaton also supplies Weatherhead thermoplastic tubing in sizes from 1/8th through 1 inch for use in robotics, air tools, air and water supply, and beverage dispensing.

Eaton's Hydraulics Group is a worldwide leader in the design, manufacture and marketing of a comprehensive line of reliable, high efficiency hydraulic systems and components for use in mobile and industrial applications. Mobile and industrial markets include agriculture, construction, mining, forestry, utility, material handling, earthmoving, truck and bus, machine tools, molding, primary metals, automotive, power generation, port machinery and entertainment.

Weatherhead has one of the industry's broadest offerings of hose and fittings that are widely used throughout multiple market applications.

Application Data

Safety information A-2
California Proposition 65 Warning A-2

Hose selection

Installation and maintenance A-3
How to order A-5

Numbering system

Hose A-6
Hose Fittings A-7
Hose Fittings Quick Identification chart A-8
Hose Selection chart A-10
Flow rate A-22
Pressure charts A-24
Fluid compatibility A-26
Hydraulic fluids & lubricating oils A-32
Hose routing and installation A-36
Analyzing failures A-37

Fluid connector

Fluid connectors identification A-40
Thread size chart A-41
Proper tube installation A-42

Maximum operating pressure A-43
Recommended wall thickness A-44
Hydraulic tubing material specifications A-44
How to measure non-threaded connections A-45
American connections A-46
ISO connections A-49
German connections A-50
French connections A-53
British connections A-53
Japanese connections A-54
O-Ring pilot thread sizes A-57
Thread engagement A-58
Metric thread dimensions A-59
Assembly torque A-60
Assembly Instructions ORS, SAE 37° Flare & Pipe . . A-61

Tubing selection

Tubing type and tubing size A-62
Flow / Velocity chart A-63
Recommended wall thickness A-65



Safety information

Important safety information and California Proposition 65 Warning

A

Safety Information

Eaton's Weatherhead Hose and Fitting Assembly Product Warning

Flexible hose lines offer many advantages over rigid tubing including routing ease, vibration absorption, sound deafening and the ability to accommodate movement of connected components. However, hose lines require caution in use not only to provide long service, but also to guard against potentially dangerous failure.

Important

The user should carefully observe the precautions listed in this catalog, including the recommendations on the selection of hose and fittings on the relevant pages, and the pages on fluid compatibility. In addition, care should be taken not to exceed the minimum bend radius listed for each hose size and type in the hose section. Maximum operating pressure should not exceed pressures listed in the hose data. Instructions for assembling fittings to different hose should be followed carefully to ensure the performance of the completed assembly.

⚠ WARNING Eaton fitting tolerances are engineered to match Eaton's Weatherhead hose tolerances. The use of Eaton fittings on hose supplied by other manufacturers and/or the use of Eaton's Weatherhead hose with fittings supplied by other manufactures may result

in the production of unreliable and unsafe hose assemblies and is neither recommended nor authorized by Eaton or any of its affiliates or subsidiaries.

⚠ WARNING Application considerations must be observed in selecting appropriate components for the application of these products contained herein. The failure to follow the recommendations set forth in this catalog may result in an unstable application which may result in serious personal injury or property damage.

EATON OR ANY OF ITS AFFILIATES OR SUBSIDIARIES SHALL NOT BE SUBJECT TO AND DISCLAIMS ANY OBLIGATIONS OR LIABILITIES (INCLUDING BUT NOT LIMITED TO ALL CONSEQUENTIAL, INCIDENTAL AND CONTINGENT DAMAGES) ARISING FROM TORT CLAIMS (INCLUDING WITHOUT LIMITATION NEGLIGENCE AND STRICT LIABILITY) OR OTHER THEORIES OF LAW WITH RESPECT TO ANY HOSE ASSEMBLIES NOT PRODUCED FROM GENUINE WEATHERHEAD HOSE FITTINGS, HOSE AND WEATHERHEAD APPROVED EQUIPMENT, AND IN CONFORMANCE WITH EATON'S WEATHERHEAD PROCESS AND PRODUCT

INSTRUCTIONS FOR EACH SPECIFIC HOSE ASSEMBLY.

Failure to follow these processes and product instructions and limitations could lead to premature hose assembly failures resulting in property damage, serious injury or death.

Routing

If the user follows the recommendations on hose line routing and installation as provided herein, improved safety and longer service life of any hose installation will result.

Hose Installation

Proper installation of the hose is essential to the proper operation and safe use of the hose and related equipment. Improper installation of the hose can result in serious injury or property damage caused by spraying fluids or flying projectiles. In order to avoid serious bodily injury or property damage resulting from improper installation of the hose, you should carefully review the information in this catalog regarding hose installation.

Some of the factors you must consider in installing the hose properly are:

- Changes in length
- Proper bend radius
- Protection from high temperature sources

- Elbows and adapters to relieve strain
- Rubbing or abrasion
- Twisting
- Improper hose movement

These factors and the other information in this catalog regarding hose installation should be considered by you before installing the hose. If you have any questions regarding proper hose installation, please contact Eaton Technical Support at 1-888-258-0222.

Hose Maintenance

Proper maintenance of the hose is essential to the safe use of the hose and related equipment. Hose should be stored in a dry place. Hose should also be visually inspected. Any hose that has a cut or gouge in the cover that exposes the reinforcement should be retired from service. Hoses should also be inspected for kinking or broken reinforcement. If the outside diameter of the hose is reduced by 20% at the spot where it is bent then the hose should be retired from service. Inadequate attention to maintenance of the hose can result in hose leakage, bursting, or other failure which can cause serious bodily injury or property damage from spraying fluids, flying projectiles, or other substances.

California Proposition 65 Warning

Regarding Eaton brass products.

CALIFORNIA PROPOSITION 65 WARNING

WARNING: This product contains lead and other chemicals which are known to the state of California to cause cancer and birth defects or other reproductive harm.

CAUTION: A Proposition 65 warning may be required for any item removed from the package for sale separately if an item is to be sold or offered for sale in California.

IT IS ILLEGAL TO USE THIS PRODUCT FOR DRINKING WATER OR OTHER POTABLE SERVICES.

CAUTION: The warning must accompany any item removed from the package for resale.

www.P65/warnings.ca.gov

Selection, installation and maintenance of hose and assemblies

The following recommendations on selection, installation and maintenance of hose assemblies were established in SAE J1273. Please read these general instructions carefully. More detailed information on many of these subjects is covered in this catalog.

1. Scope

Hose (also includes hose assemblies) has a finite life and there are a number of factors which will reduce its life. This recommended practice is intended as a guide to assist system designers and/or users in the selection, installation, and maintenance of hose.

The designers and users must make a systematic review of each application and then select, install, and maintain the hose to fulfill the requirements of the application. The following are general guidelines and are not necessarily a complete list.

⚠ Warning: improper selection, installation, or maintenance may result in premature failures, bodily injury, or property damage.

2. References

2.1 Applicable documents

The following publications form a part of this specification to the extent specified herein. The latest issue of SAE publications shall apply.

2.1.1 SAE publications

Available from SAE,
400 Commonwealth Drive,
Warrendale, PA 15096-0001.

J516—Hydraulic hose fittings

J517—Hydraulic hose

3. Selection

The following is a list of factors which must be considered before final hose selection can be made.

3.1 Pressure

After determining the system pressure, hose selection must be made so that the recommended maximum operating pressure is equal to or greater than the system pressure. Surge pressures higher than the maximum operating pressure will shorten hose life and must be taken into account by the hydraulic designer.

3.2 Suction

Hoses used for suction applications must be selected to insure the hose will withstand the negative pressure of the system.

3.3 Temperature

Care must be taken to insure that fluid and ambient temperatures, both static and transient, do not exceed the limitations of the hose. Special care must be taken when routing near hot manifolds.

3.4 Fluid compatibility

Hose selection must assure compatibility of the hose tube, cover and fittings with the fluid used. Additional caution must be observed in hose selection for gaseous applications.

3.5 Size

Transmission of power by means of pressurized fluid varies with pressure and rate of flow. The size of the components must be adequate to keep pressure losses to a minimum and avoid damage to the hose due to heat generation or excessive turbulence.

3.6 Routing

Attention must be given to optimum routing to minimize inherent problems.

3.7 Environment

Care must be taken to insure that the hose and fittings are either compatible with or protected from the environment to which they are exposed. Environmental conditions such as ultraviolet light, ozone, salt water, chemicals, and air pollutants can cause degradation and premature failure and, therefore, must be considered.

3.8 Mechanical loads

External forces can significantly reduce hose life. Mechanical loads which must be considered include excessive flexing, twist, kinking, tensile or side loads, bend radius, and vibration.

Use of swivel-type fittings or adapters may be required to insure no twist is put into the hose. Unusual applications may require special testing prior to hose selection.

3.9 Abrasion

While hose is designed with a reasonable level of abrasion resistance, care must be taken to protect the hose from excessive abrasion which can result in erosion, snagging and cutting of the hose cover. Exposure of the reinforcement will significantly accelerate hose failure.

3.10 Proper end fitting

Care must be taken to insure proper compatibility exists between the hose and coupling selected based on the manufacturer's recommendations substantiated by testing to industry standards such as SAE J517. End fitting components from one manufacturer are usually not compatible with end fitting components supplied by another manufacturer (i.e., using a hose fitting nipple from one manufacturer with a hose socket from another manufacturer). It is the responsibility of the fabricator

to consult the manufacturer's written instructions or the manufacturer directly for proper end fitting componentry.

3.11 Length

When establishing proper hose length, motion absorption, hose length changes due to pressure, as well as hose and machine tolerances must be considered.

3.12 Specifications and standards

When selecting hose, government, industry and manufacturers' specifications and recommendations must be reviewed as applicable.

3.13 Hose cleanliness

Hose components vary in cleanliness levels. Care must be taken to insure that the assemblies selected have an adequate level of cleanliness for the application.

3.14 Electrical conductivity

Certain applications require that hose be nonconductive to prevent electrical current flow. Other applications require the hose to be sufficiently conductive to drain off static electricity. Hose and fittings must be chosen with these needs in mind.

4. Installation

After selection of proper hose, the following factors must be considered by the installer.

4.1 Pre-installation inspection

Prior to installation, a careful examination of the hose must be performed. All components must be checked for correct style, size and length. In addition, the hose must be examined for cleanliness, I.D. obstructions, blisters, loose cover, or any other visible defects.

Hose selection

General hose selection information

A

Selection, installation and maintenance of hose and assemblies

The following recommendations on selection, installation and maintenance of hose assemblies were established in SAE J1273. Please read these general instructions carefully. More detailed information on many of these subjects is covered in this catalog.

4.2 Follow manufacturers' assembly instructions

Hose assemblies may be fabricated by the manufacturer, an agent for or customer of the manufacturer, or by the user. Fabrication of permanently attached fittings to hydraulic hose requires specialized assembly equipment. Field attachable fittings (screw style and segment clamp style) can usually be assembled without specialized equipment although many manufacturers provide equipment to assist in the operation.

SAE J517 hose from one manufacturer is usually not compatible with SAE J516 fittings supplied by another manufacturer. It is the responsibility of the fabricator to consult the manufacturer's written assembly instructions or the manufacturers directly before intermixing hose and fittings from two manufacturers. Similarly, assembly equipment from one manufacturer is usually not interchangeable with that of another manufacturer. It is the responsibility of the fabricator to consult the manufacturer's written instructions or the manufacturer directly for proper assembly equipment. Always follow the manufacturer's instructions for proper preparation and fabrication of hose assemblies.

4.3 Minimum bend radius

Installation at less than minimum bend radius may significantly reduce hose life. Particular attention must be given to preclude sharp bending at the hose/fitting juncture.

4.4 Twist angle and orientation

Hose installations must be such that relative motion of machine components produces bending of the hose rather than twisting.

4.5 Securement

In many applications, it may be necessary to restrain, protect, or guide the hose to protect it from damage by unnecessary flexing, pressure surges, and contact with other mechanical components. Care must be taken to insure such restraints do not introduce additional stress or wear points.

4.6 Proper connection of ports

Proper physical installation of the hose requires a correctly installed port connection while insuring that no twist or torque is put into the hose.

4.7 Avoid external damage

Proper installation is not complete without insuring that tensile loads, side loads, kinking, flattening, potential abrasion, thread damage, or damage to sealing surfaces are corrected or eliminated.

4.8 System check out

After completing the installation, all air entrapment must be eliminated and the system pressurized to the maximum system pressure and checked for proper function and freedom from leaks.

Note: Avoid potential hazardous areas while testing.

5. Maintenance

Even with proper selection and installation, hose life may be significantly reduced without a continuing maintenance program. Frequency should be determined by the severity of the application and risk potential. A maintenance program should include the following as a minimum.

5.1 Hose storage

Hose products in storage can be affected adversely by temperature, humidity, ozone, sunlight, oils, solvents, corrosive liquids and fumes, insects, rodents and radioactive materials. Storage areas should be relatively cool and dark and free of dust, dirt, dampness and mildew.

5.2 Visual inspection

Any of the following conditions requires replacement of the hose:

- a. Leaks at fitting or in hose (leaking fluid is a fire hazard)
- b. Damaged, cut, or abraded cover (any reinforcement exposed)
- c. Kinked, crushed, flattened, or twisted hose
- d. Hard, stiff, heat cracked or charred hose
- e. Blistered, soft, degraded, or loose cover
- f. Cracked, damaged, or badly corroded fittings
- g. Fitting slippage on hose

5.3 Visual inspection

The following items must be tightened, repaired, or replaced as required:

- a. Leaking port conditions
- b. Clamps, guards, shields
- c. Remove excessive dirt buildup
- d. System fluid level, fluid type, and any air entrapment

5.4 Functional test

Operate the system at maximum operating pressure and check for possible malfunctions and freedom from leaks.

Note: Avoid potential hazardous areas while testing.

5.5 Replacement intervals

Specific replacement intervals must be considered based on previous service life, government or industry recommendations, or when failures could result in unacceptable down time, damage, or injury risk.

How to order

Accurate processing and prompt delivery of your order depends on easy identification of your requirements. Please order Weatherhead brand parts using correct part numbers as described in this catalog. Inquiries and orders should be directed to your Weatherhead distributor or:

Eaton
14615 Lone Oak Road
Eden Prairie, MN 55344
952-937-9800;
888-258-0222;
Fax: 952-974-7722
www.eaton.com/hydraulics

Part numbers and dash sizes

Dash size designates the nominal size in 16th of an inch. This number immediately follows the part number and is separated from it with a dash.

Dimensions

Dimensions given in this catalog for Weatherhead products are approximate and should be used for reference only. Exact dimensional information for a given product is subject to change and varying tolerances; contact Eaton directly for full current information.

WARNING

Hose assemblies

Eaton manufactures the terminal ends of our hose fittings to the appropriate requirements established by the SAE. Therefore, the performance ratings of these hose fittings meet the SAE requirements. It is possible to order a hose assembly with a fitting terminal end that has a performance rating lower than the hose rating. When ordering hose assemblies, please keep the connecting

end performance rating in mind since this may affect overall hose assembly performance. Hose assembly components (hose and fittings) are easily assembled in the field. However, factory assembled reusable and crimped hose assemblies are available. For complete information, contact Eaton.

Hose selection

Numbering system

A

Numbering system - Hose

Hose numbering system

- ① Weatherhead hose is generally designated with the letter 'H.'*
- ② Each hose is assigned a three or four digit base number from 001-9999, i.e., H069, H280, H470, H571.
- ③ The last two digits indicate inside hose diameter (I.D.) in sixteenths of an inch.

H 280 08

①
②
③

In the example used above 08 is equal to 8/16" – or 1/2" I.D. hose.

Exceptions: H059, H069, H166, H169, H213, H229, H239, H366, H429, H569 and H757.

The I.D. sizes of these hose deviate somewhat from the above standard. The sizing method used on these hoses is based on **deducting twice the wall thickness** from the O.D. of the connecting tubing to determine the I.D. of the hose. In other words, match the inside diameters rather than the dash sizes when going from tubing to hose.

See **example 1**.

Examples:

	Actual Hose I.D.	Nominal Hose I.D.	Tubing I.D.	Tubing O.D.
H06906	5/16	3/8	5/16	3/8
H06910	1/2	5/8	1/2	5/8

Table 1 shows standard hose size and H069 type hose sizes and dash numbers. Wherever these hoses are listed in this catalog, the size is listed and the dash number is the last two digits of the Catalog Number.

Table 1 – Catalog numbers for Hose sizes

Actual Hose I.D.	Standard Catalog Number	H069 Type Catalog Numbers
3/16	03	04
1/4	04	05
5/16	05	06
3/8	06	
13/32		08
7/16	07	
1/2	08	10
5/8	10	12
3/4	12	
7/8		16
1	16	
1-1/8		20
1-1/4	20	
1-3/8		24
1-1/2	24	
1-13/16		32
2	32	
2-3/8		40
3		48

Numbering system - Hose fittings

Hose fittings numbering system

Every type of Weatherhead hose fitting is designed to fit a certain group of hose with limiting dimensions and tolerances. For your convenience the hoses used on each fitting style are indicated in the hose fitting catalog listings.

Crimp fittings

08 Z-25 8

① ② ③ ④

- ① The **first two digits** indicate hose size (I.D.) in sixteenths of an inch.
The exceptions to this are **the spiral** and truck hose.
Spiral hose fittings use the hose base number as a prefix to the size. Example: 47012E.
Truck hose fittings use the base number 069 as a prefix to the size. Example: 06908E. **Refer to the top** of the catalog page where these hose fittings are detailed for recommended hose types.
- ② Hose fitting type and material. Refer to Table 2.
This letter is always followed by a dash.
- ③ In the Quick Identification table on page A-8 (Numbering systems - hose fittings), find the connection end part suffix that is nearest to, but less than, your part suffix.
For example, if your connection end suffix is 258, the nearest lower part suffix in the table is 250, which indicates your connection end is female pipe swivel. Subtract this number to find your end connection size in sixteenths of an inch. In this example, 258 - 250 is 8, or 8/16 of an inch.
- ④ The last one or two digits indicate the size of the end connection in sixteenths of an inch. Refer to individual catalog listing for metric and specialty ends.

Field Attachable fittings

425 08 N-25 8

① ② ③ ④ ⑤

- ① Description of basic hose.
The exceptions are the 247 series and clamp type ends. These ends are designed for use with a variety of hose types. Refer to the top of the catalog page where these hose fittings are detailed for recommended hose types.
- ② Hose size (I.D.) in sixteenths of an inch, or as shown in Table 1.
- ③ Hose fitting type and material. Refer to Table 2.
This letter is always followed by a dash.
- ④ In the Quick Identification table on page A-8 (Numbering systems- hose fittings), find the connection end part suffix that is nearest to, but less than, your part suffix.
For example, if your connection end suffix is 258, the nearest lower part suffix in the table is 250, which indicates your connection end is female pipe swivel. Subtract this number to find your end connection size in sixteenths of an inch. In this example, 258 - 250 is 8, or 8/16 of an inch.
- ⑤ The last one or two digits indicate the size of the end connection in sixteenths of an inch. Refer to individual catalog listing for metric and specialty ends.

Table 2 – Standard Fitting type and Material code

Code letter	Fitting type	Material
B	Field Attachable	Brass
C	Crimped	Brass
D	Field Attachable*	Steel*
E	Crimp	Steel
N	Field Attachable	Steel
P	Crimp	Brass
S	Crimp Stainless	Steel
T	Field Attachable*	Brass
U	Crimp	Steel
Z	Crimp	Steel

*High flow hose assemblies

Hose selection

Numbering system

A

Numbering system - Hose fittings

Quick Identification

The Quick Identification chart is designed to offer quick identification of Weatherhead hose fitting series. Included in this chart are: base numbers, descriptions, hose fitting series.

Catalog numbers may be derived by adding the size in sixteenths of an inch to the base. Example: 100 series 3/4" male pipe rigid. 3/4" = 12/16" thus 100 + 12 = 112.

Part & suffix	Hose fitting	Style	Part & suffix	Hose fitting	Style
00A	Male DIN (Light)	Rigid	640	JIC 37° female 90° tube elbow long	Swivel
00C	Female DIN (Light)	Swivel	660	JIC 37° female 90° tube elbow	Swivel
00D	Female DIN 45° (Light)	Swivel	680	JIC 37° female 45° tube elbow	Swivel
00E	Female DIN 24° 45° tube elbow	Swivel	750	Flareless tube Ermeto®	Rigid
00F	Male DIN (Heavy)	Rigid	950	Flareless tube Ermeto® 45°	Rigid
00K	Female 30° flare (Komatsu)	Swivel	970	Flareless tube Ermeto® 90°	Rigid
00L	Female JIS 30° flare	Swivel	A00	Inverted female	Rigid
00P	Female flat face BSPP	Swivel	A20	Female ORS 90° tube elbow short	Swivel
00S	Ready LOK®	Rigid	A60	Female ORS 90° tube elbow long	Swivel
0PW	Pressure washer	Swivel	B00	Inverted male	Swivel
30T	Straight tube-metric	Rigid	B20	Inverted male swivel extended	Swivel
40P	British Std. 60° cone parallel female pipe 45°	Swivel	B40	Inverted male 45° tube elbow	Swivel
50C	Female DIN (heavy)	Swivel	B60	Inverted male 90° tube elbow	Swivel
50D	Female DIN 90° (light)	Swivel	BD00	Cat flange 22.5° Elbow	Code 62
50E	Female DIN 90° (heavy)	Swivel	BD30	Cat flange 30° elbow	Code 62
70P	Brit. Std 60° cone parallel female pipe 90°	Swivel	BD60	Cat flange 60° elbow	Code 62
050	Female straight pipe	Swivel	BE00	Cat flange 67.5° Elbow	Code 62
100	Male pipe	Rigid	C00	Male pipe 90° elbow	Rigid
150	Male pipe, British standard tapered	Rigid	C30	Female grease tap	Rigid
200	Female pipe	Rigid	C60	SAE 37° female 60° tube elbow	Swivel
250	Female pipe	Swivel	D00	Flange straight	Code 62
300	SAE 45° male	Rigid	D40	Flange 45° tube elbow	Code 62
350	British Std 60° cone parallel female pipe	Swivel	D70	Flange 90° tube elbow	Code 62
380	SAE 45° male 45° elbow	Rigid	E00	Inverted male 90° elbow	Swivel
400	SAE 45° female	Swivel	E40	Inverted male 45° tube elbow	Swivel
440	SAE 45° female 90° tube elbow long	Swivel	E60	Male ORS straight	Rigid
460	SAE 45° female 90° tube elbow short	Swivel	G00	Flange straight	Code 61
480	SAE 45° female 45° tube elbow	Swivel	G09	Flange straight (Komatsu)	Special
500	JIC 37° male	Rigid	G40	Flange 45° tube elbow	Code 61
550	JIC 37° female 90° tube elbow	Swivel	G69	Flange 45° tube elbow (Komatsu)	Special
600	JIC 37° female	Swivel	G70	Flange 90° tube elbow	Code 61

Teflon is a trademark of The Chemours Company FC, LLC used under license by Eaton.

Numbering system - Hose fittings

Quick Identification (continued)

The Quick Identification chart is designed to offer quick identification of Weatherhead hose fitting series. Included in this chart are: base numbers, descriptions, hose fitting series.

Catalog numbers may be derived by adding the size in sixteenths of an inch to the base. Example: 100 series 3/4" male pipe rigid.
3/4" = 12/16" thus 100 + 12 = 112.

Part & suffix	Hose fitting	Style
G99	Flange 90° tube elbow	Special
H00	Flange 22-1/2° tube elbow	Code 61
H20	Flange 30° tube elbow	Code 61
H50	Flange 60° tube elbow	Code 61
H60	Flange 67-1/2° tube elbow	Code 61
H70	Flange 100° tube elbow	Code 61
H80	Flange 110° tube elbow	Code 61
H90	Flange 135° tube elbow	Code 61
J00	Male pipe	Swivel
J33	Female ORS 90° tube elbow med.	Swivel
J63	Female ORS straight	Swivel
K00	Flange straight "Cat flange"	Code 62
K30	Flange 45° tube elbow "Cat flange"	Code 62
K60	Flange 90° tube elbow "Cat flange"	Code 62
L00	Banjo (Ford tractor)	Special
L10	JIC 37° female 30° tube elbow	Swivel
L40	Male 45° tube elbow O-ring port	Swivel
L60	Female 45° ORS tube elbow	Swivel
M00	Male pipe 90° elbow	Swivel
N20	Split flange 30° tube elbow	Code 62
N50	Split flange 60° tube elbow	Code 62
N60	Split flange 67-1/2° tube elbow	Code 62
P00	Male straight thread O-ring	Rigid
P50	Male pipe, British Std. 60° Cone parallel	Rigid
R00	Male straight thread O-ring	Swivel

Part & suffix	Hose fitting	Style
R60	Male straight thread O-ring 90° elbow	Swivel
S60	Female ORS straight	Swivel
T00	Straight tube	Rigid
T50	Straight tube-long	Rigid
W00	Bumped tube O-ring male	Rigid
W40	Bumped tube O-ring female 45° tube elbow	Swivel
W60	Bumped tube O-ring male 90° tube elbow	Rigid
X00	SAE 45° Flare male 90° elbow	Rigid
X20	30° Flare female (P.T.T. Thread for diesel applications)	Swivel
X60	SAE 37° male 90° elbow	Rigid
X80	Compressor discharge (Teflon hose)	Flange
Y00	Hose mender	Rigid
Y20	Male connector	Rigid
Y30	Male connector w/spring guard	Rigid
Y33	Hose splicer	Special
Y50	Air brake connection tube	Rigid
Y60	Air brake slider	Rigid
Y70	Air brake	Swivel
Y80	Female connector	Swivel
Z00	Bumped tube O-ring male	Swivel
Z20	Bumped tube O-ring 45° tube elbow	Swivel
Z40	Bumped tube O-ring female	Swivel
Z50	Bumped tube O-ring female w/service port	Swivel
Z60	Bumped tube O-ring male 90° tube elbow	Swivel
Z80	Bumped tube O-ring female 90° tube elbow	Swivel
Z90	Bumped tube O-ring 90° tube elbow w/service port	Swivel

Teflon is a trademark of The Chemours Company FC, LLC used under license by Eaton.

Hose selection

Hose Selection chart

A

How to use chart:

Locate the hose I.D. required and move to the right to the correct pressure. Then move up or down in this column for data on material, temperature, etc. to quickly determine whether the hose meets your requirements.

For complete information on any hose refer to hose catalog page number.

Selection of hose:

Selection of the proper hose for the application is essential to the proper operation and safe use of the hose and related equipment. Inadequate attention to selection of the hose for your application can result in hose leaking, bursting, or other failure which can cause serious bodily injury or property damage from spraying fluids or flying projectiles. You should carefully review the information in this catalog.

HYDRAULIC HOSE												
	Braided Hose - Premium						Spiral Hose - Premium					
HOSE	H180	H145R	H190H	H280	H290H	H245L	H430	H430R	EC525	H471	EC600	EC810
Page	B-6	B-7	B-8	B-9	B-10	B-11	B-12	B-13	B-14	B-15	B-16	B-17
Usage	Transfer of low to medium pressure hydraulic & water-based fluids	Transfer of medium pressure hyd. & water-based fluids in abrasive applications	Transfer of low to medium pressure, high temp. hydraulic & water-based fluids	Transfer of medium to high pressure hydraulic & water-based fluids	Transfer of medium to high pressure hydraulic & water-based fluids	High pressure Transfer of low temp. hydraulic & water-based fluids	Transfer of very high pressure hydraulic & water-based fluids	Transfer of very high pressure hyd. & water-based fluids in abrasive applications	Transfer of high pressure high temp. hydraulic & water-based fluids	Transfer of super high pressure hydraulic & water-based fluids	Ultra flexible Transfer of super high pressure hydraulic & water-based fluids	Ultra flexible Transfer of high pressure low temp. hydraulic & water-based fluids
Meets	MSHA, EN857 1SC	—	MSHA, EN853 1SN	MSHA, *ABS, *USCG, ISO 1436, EN857 2SC	MSHA, EN853 2SN *USCG	MSHA, EN857 2SC	*ABS, MSHA *USCG, *DNV EN856 R12, DIN856/4SP (-8 to -16)	*ABS, *DNV, EN856 R12	MSHA, *ABS, *USCG, EN856 R12	*ABS, DNV, MSHA, *USCG, EN856 R13, ISO 3862 R13	ISO 18752-DC* MSHA *ABS, *DNV, *USCG	MSHA, EN856 R15
SAE No.	100R1 Type S	100R17	100R1 Type S	J1942, 100R16 Type S	100R2 AT	100R16 Type S	100R12	100R12	100R12	100R13	100R15	100R15
Temp. Range °F	-50°F to +260°F	-40°F to +212°F	-40°F to +302°F	-40°F to +260°F	-40°F to +302°F	-70°F to +212°F	-40°F to +260°F	-40°F to +250°F	-40°F to +300°F (-40°F to +180°F phosphate-ester base fluids)	-40°F to +260°F	-40°F to +250°F	-70°F to +212°F
Inner Tube	Nitrile	Nitrile	CPE	Nitrile	CPE	Low temp. Nitrile	Nitrile	Nitrile	CPE	Nitrile	Nitrile	Low temp. Nitrile
Reinforcement	1 wire braid	1 wire braid (-4 to -8) 2 wire braids (-10 to -16)	1 wire braid	2 wire braids	2 wire braids	2 wire braids	4 wire spiral	4 wire spiral	4 wire spiral	4 wire spiral (-12 to -24), 6 wire spiral (-32)	4 wire spiral (-12, -16) 6 wire spiral (-20)	4 wire spiral (-12, -16) 6 wire spiral (-20 to -32)
Cover	Weather-SHIELD™	UHMWPE	CPE	Weather-SHIELD™	CPE	Weather-SHIELD™	Weather-SHIELD™	UHMWPE	CPE	Nitrile	Weather-SHIELD™	Nitrile
Hose I.D. - Maximum recommended operating pressure - PSI												
3/16												
1/4	3700	3000	3265	6500	5800	6000						
5/16												
3/8	3400	3000	2610	5800	4800	5000	6500	4000				6100
13/32												
7/16												
1/2	3200	3000	2320	5000	4000	4500	6000	4000				6100
5/8	2025	3000	1885	4000	3630	4000	6000	4000				6100
3/4	2000	3000	1525	3500	3120	3500	5500	4000	5000	5076	6100	6100
7/8					2400							
1	1500	3000	1275	3000		2800	5100	4000	5000	5076	6100	6100
1-1/8												
1-1/4	1000		900	2500	2250	2300	4500	3000	3500	5076	6100	6100
1-1/2	750			2000	1750	2000	4000	2500	3500	5076		6100
1-3/8												
1-3/16												
2	600			1600	1500	1500	4000	2500	3250	5076		5100
2-3/8												
2-1/2												
Hose fittings												
Crimp	Z Series	Z Series	Z Series	Z Series	Z Series	Z Series	4S Series	4S/6S Series	4S Series	4S/6S Series	4S/6S Series	4S/6S Series
Field Attach.	—	—	—	—	—	—	—	—	—	—	—	—

* Listing may vary by hose style and size, some hoses may require firesleeve or special procedures depending on specific applications. Contact Eaton for details.

HYDRAULIC HOSE											
	Premium	Braided Hose - Other								Spiral Hose - Other	
HOSE	EC850	H190	H290	H145	H545	H400	H421	EC230	H345	H464	EC910
Page	B-18	B-19	B-20	B-21	B-22	B-23	B-24	B-24	B-25	B-26	B-26
Usage	Transfer of ultra high pressure petroleum and water-glycol based fluids	Transfer of low to medium pressure hydraulic and water-based fluids	Transfer of medium to high pressure hydraulic and water-based fluids	Transfer of medium pressure hydraulic and water-based fluids	Transfer of medium constant pressure hydraulic and water-based fluids	Transfer of high pressure hydraulic and water-based fluids	Hydraulic jacking system	Large bore, high flow transfer of medium pressure hydraulic and water-based fluids	Pressure washer	Transfer of very high pressure hydraulic and water-based fluids	Waterblast service with water, water-soap, and emulsion
Meets	MSHA IC-84, DIN 5510	*ABS, MSHA ISO 1436-1 1SN EN853 1SN	MSHA ISO 1436-1 2SN EN853 2SN	MSHA	—	—	—	—	MSHA	EN856 4SH	ISO 7751 EN1829-2
SAE No.	100R15	J1942 100R1 Type S	100R2 Type S	100R17, J1942/1 (hyd. only)	—	100R19	—	100R2 Type S	—	—	—
Temp. Range °F	-40°F to +212°F	-40°F to +260°F (petro-based hyd. fluids), -40°F to +158°F (water-based hyd. fluids), +32°F to +158°F (water)	-40°F to +260°F (petro-based hyd. fluids), -40°F to +159°F (water-based hyd. fluids)	-40°F to +250°F (for -4 to -8), -40°F to +212°F (for -10 to -16)	-40°F to +250°F	-40°F - +212°F	-40°F to +212°F	-40°F to +212°F	0°F to +200°F Press. washer -40°F to +250°F Hyd. service	-40°F to +212°F	-40°F to +200°F -14°F to +176°F (continuous service temp. range)
Inner Tube	Nitrile	Nitrile	Nitrile	Nitrile	Nitrile	Nitrile	Nitrile	Nitrile	Nitrile	Nitrile	Nitrile
Reinforcement	4 spiral wire (-10, -12, -16) 6 spiral wire (-20)	1 wire braid	2 wire braids	1 wire braid (-4 to -8), 2 wire braids (-10 to -16)	1 wire braid (-4 to -8), 2 wire braids (-10 to -16)	2 wire braids	2 wire braids	2 wire braid	1 wire braid	4 spiral wire plies	Heavy 4 spiral wire
Cover	Nitrile	Weather-SHIELD™	Weather-SHIELD™	Neoprene	Abrasion resistant woven nylon	Nitrile	Nitrile	Nitrile	Nitrile	Nitrile	Nitrile cover labeled per WJTA
Hose I.D. - Maximum recommended operating pressure - PSI											
3/16											
1/4		3700	6500	3045	3000	4000	10000		3000		
5/16											
3/8		3400	5300	3045	3000	4000	10000		3000		
13/32											
7/16											
1/2		2900	4500	3045	3000	4000			3000		16000
5/8	7250	1885	4000	3045	3000	4000					
3/4	7250	2000	3500	3045	3000	4000				6090	14500
7/8											
1	7250	1500	3000	3045	3000					5510	10200
1-1/8											
1-1/4	7250	1000	2500							5075	
1-1/2		750	2000							4350	
1-3/8											
1-3/16											
2		600	1600							3625	
2-3/8											
2-1/2								1150			
Hose fittings											
Crimp	1W Series	Z Series	Z Series	Z Series	Z Series	Z Series	Z Series	E-HOBR-BB001-E	Z Series	4S Series	Contact Eaton
Field Attach.	—	—	—	—	—	—	—	—	—	—	—

* Listing may vary by hose style and size, some hoses may require firesleeve or special procedures depending on specific applications. Contact Eaton for details.

Hose selection

Hose selection chart

For complete information on any hose refer to hose catalog page number.

A

HYDRAULIC HOSE										
	Suction Hose - Specialty		Thermoplastic							
HOSE	H039	H039H	3130	3740	37AL	3R80	3E80	30CT	3V10	3VE0
Page	B-27	B-28	B-29	B-30	B-31	B-32	B-32	B-33	B-34	B-35
Usage	Hydraulic suction hose	Hydraulic suction hose	Material handling; forklifts; chemical transfer; marine steering	Aerial equipment; mobile hydraulics; rescue apparatus and tools	Electric utility trucks; hydraulic systems; mobile equipment	Hydraulic tools; mobile equipment; high-pressure chemical transfer	Aerial equipment; mobile hydraulics; rescue tools	Forklifts; material handling; freezer applications	High pressure test equipment and hydraulic tools; rescue equipment and tools	High voltage; rescue equipment and tools; mobile machinery; aerial equipment
Meets	MSHA *ABS	—	—	—	ANSI A92.2	—	—	—	—	—
SAE No.	100R4, J1942/1 (hyd. only)	100R4	100R7	100R7, J517 non-conductive hose construction	100R7, J517 non-conductive hose construction	100R8	100R8, J517 non-conductive hose construction	100R18	—	J517 non-conductive hose construction
Temp. Range °F	-40°F to +275°F	-40°F to +302°F	-40°F to +212°F; -40°F to +150°F with water-based or fire-resistant fluids	-40°F to +212°F; -40°F to +150°F with water-based or fire-resistant fluids	-40°F to +212°F; -40°F to +140°F with water-based or fire-resistant fluids	-40°F to +212°F; -40°F to +150°F with water-based or fire-resistant fluids	-65°F to +212°F; -40°F to +150°F with water-based or fire-resistant fluids	-65°F to +200°F; -65°F to +150°F with water-based or fire-resistant fluids	-40°F to +150°F	-40°F to +150°F
Inner Tube	CPE	CPE	Nylon-lined	Nylon-lined	Polyester	Nylon	Nylon	Polyester	Nylon-lined	Nylon-lined
Reinforcement	1 helical wire between two textile layers, 1 fiber braid	1 helical wire between two textile layers, 1 fiber braid	Spiral or braided synthetic fiber	Braided synthetic fiber reinforcement (-08)	Braided synthetic fiber	Braided, synthetic fiber	Braided synthetic fiber	Braided synthetic fiber	Spiral, high tensile aramid fiber	Spiral, high tensile aramid fiber
Cover	Neoprene	CPE	Black perforated polyurethane	Orange non-perforated polyurethane	Orange, non-perforated, non-stick polyurethane	Black perforated polyurethane	Orange, non-perforated polyurethane	Black perforated, non-stick polyester	Black, perforated polyurethane	Orange, non-perforated polyurethane
Hose I.D. - Maximum recommended operating pressure - PSI										
3/16			2500							
1/4			3050		3000	5100	5100	3050	10153	10153
5/16			3000	2800	3000 / 2750	5100	5100	3050	10153	10153
3/8			2550		3000 / 2500			3050		
13/32			2300	2300	3000 / 2250	4050	4050	3050	8000	8000
7/16										
1/2										
5/8			2050	2050	3000 / 2250	3550	3550	3050		
3/4	305	305						3050		
7/8			1250	1250		2300	2300			
1	247	247								
1-1/8			1000	1000		2050	2050			
1-1/4	203	203								
1-1/2	152	152								
1-3/8										
1-3/16										
2	102	102								
2-3/8										
2-1/2										
Hose fittings										
Crimp	Z Series	Z Series	Refer to Synflex® catalog E-H00V-MC001-E	Refer to Synflex catalog E-H00V-MC001-E	Refer to Synflex catalog E-H00V-MC001-E	Refer to Synflex catalog E-H00V-MC001-E	Refer to Synflex catalog E-H00V-MC001-E	Refer to Synflex catalog E-H00V-MC001-E	Refer to Synflex catalog E-H00V-MC001-E	Refer to Synflex catalog E-H00V-MC001-E
Field Attach.	—	—	—	—	902 Series	—	—	—	—	—

*Listing may vary by hose style and size, some hoses may require firesleeve or special procedures depending on specific applications. Contact Eaton for details.

HOSE	GENERAL PURPOSE HOSE							INDUSTRIAL HOSE				
	General Purpose Hose							Air and Multipurpose Hose				
	H009	H017	H100	H101	H201	H275	H332	H6009	EHA500	H9949	H1776 H1777	H201
Page	C-3	C-4	C-5	C-6	C-7	C-8	C-8	D-2	D-2	D-2	D-2	D-2
Usage	Air, petroleum, water based hydraulic fluid	Low pressure fuel and oil lines; hydraulic return lines	Air, lubricating oil, water, diesel fuel	Air, petroleum, water based hydraulic fluid, diesel fuel	Air, petroleum, water based hydraulic fluid, diesel fuel	Air and water	Air, lubricating oil, water, diesel fuel	Air-operated construction equipment	High-pressure air service	Air and water transfer	Air and water transfer, air tools	Air and water transfer, pneumatic tools, air tools
Meets	100R6	MSHA, 100R3	—	MSHA	MSHA (red, green, blue, and black only)	—	—	—	—	—	—	MSHA (red, green, blue, and black only)
SAE No.	J1942/1	J1942/1/1 (Hyd. only)	—	—	—	—	—	—	—	—	—	—
Temp. Range °F	-40°F to +212°F	-40°F to +212°F	-40°F to +212°F	-40°F to +212°F	-40°F to +212°F (Air/ water) -40°F to +260°F (Oil)	-10°F to +150°F	-40°F to +302°F	-40°F to +250°F	-40°F to +200°F	-40°F to +180°F	-40°F to +180°F	-40°F to +212°F (Air/ water) -40°F to +260°F (Oil)
Inner Tube	Nitrile	Nitrile	Nitrile	Nitrile	Nitrile	PVC	CPE	Nitrile (RMA Class A)	Oil-resistant Nitrile blend	Non-Conductive Nitrile	Nitrile (RMA Class A)	Vinyl Nitrile (RMA Class A)
Reinforcement	1 textile braid	2 textile braids	1 textile braid	1 textile braid	1 textile braid	Textile: 2 spirals	1 textile braid	1"-1.25" 1-wire braid, 1.5"-3" 2-wire braid, 4" 3-wire braid	High-tensile steel wire	2-fiber braids	1-fiber braid (H1777); 2-fiber braid (H1776)	1-fiber braid
Cover	Neoprene	Neoprene	Textile braid (black)	Neoprene	Neoprene (black), Vinyl Nitrile (colors)	PVC/ Pinpricked	CPE (black)	Pin-Pricked Carboxylated Nitrile	Pin-pricked, Abrasion/ Ozone/ Weather Resistant Nitrile	Non-Conductive Vinyl Nitrile	Vinyl Nitrile	Neoprene (black), Vinyl Nitrile (colors)
Hose I.D. - Maximum Recommended Operating Pressure - PSI												
3/16												
1/4	400	1250	350	350	300	250	250			275	325	300
5/16	400		350	350							325	
3/8	400	1125	350	350	300	250	250			275	325	300
13/32												
7/16												
1/2	400	1000	350	350	300	250	250		600	275	325	300
5/8			350	350	300		250				325	300
3/4		750	350	350	300	250	250		600	275	325	300
7/8												
1		565			200	200		1000	600	275	325	200
1-1/8												
1-1/4		375				200		800	600		325	
1-1/2						200		600	600		325	
1-3/8												
1-13/16												
2						125		600	600			
2-3/8												
2-1/2								600				
3								600	600			
Hose Fittings												
Crimp	E Series	—	—	—	—	E Series, 265 P Series, Z Series	—	Z Series	—	Z Series	Z Series	—
Field Attach.	009 B Series	—	100 B Series	100 B Series	100 B Series	—	100 B Series	—	—	—	—	100 B Series

*Listing may vary by hose style and size, some hoses may require firesleeve or special procedures depending on specific applications. Contact Eaton for details.

Hose selection

Hose selection chart

For complete information on any hose refer to hose catalog page number.

A

INDUSTRIAL HOSE (continued)											
Air and Multipurpose Hose (continued)							Chemical Hose				
HOSE	H275	H1812	H1981	H1982	H0105	H0106	H0523	H0599	H0554	H0378	H0345
Page	D-2	D-2	D-2	D-2	D-2	D-2	D-3	D-3	D-3	D-3	D-3
Usage	Air and water transfer, air tools, lubricated air	Air and water transfer, pneumatic tools, water-based fertilizers and pesticides	Air and water transfer	Air and water transfer	Air and water transfer	Air and water applications	Transfer of acids, chemicals, solvents, and petroleum products; food transfer; portable water	Transfer of acids, chemicals, solvents, and petroleum products; loading and unloading, pumping, suction, or gravity flow discharge, portable water	Transfer of acids, chemicals, solvents, and petroleum products; loading and unloading, pumping, suction, or gravity flow discharge	Transfer of acids, chemicals, solvents, and petroleum products; loading and unloading, pumping, suction, or gravity flow discharge	Transfer of acids, chemicals, solvents, and petroleum products; loading and unloading, pumping, suction, or gravity flow discharge
Meets	—	—	—	—	—	—	FDA	FDA	FDA	—	—
SAE No.	—	—	—	—	—	—	—	—	—	—	—
Temp. Range °F	-10°F to +150°F	-40°F to +180°F	-40°F to +180°F	-40°F to +180°F	-40°F to +180°F	-40°F to +180°F	-40°F to +250°F	-40°F to +250°F	-40°F to +250°F	-45°F to +150°F	-45°F to +180°F
Inner Tube	PVC	EPDM rubber	Nitrile blend	Nitrile blend	EPDM	EPDM	UHMW-PE	UHMW-PE	UHMW-PE	XLPE	EPDM
Reinforcement	2-spiral fiber	2-fiber braid	2- or 4-fiber spiral	2- or 4-fiber spiral	4-fiber spiral, 2-fiber braid (-20 & -24)	2-spiral fiber	2-ply fiber with dual helical wires	2-ply fiber with dual helical wire	2-wire braid, dual stainless steel anti-static wire, 3.00" and 4.00" helical wire	2-ply fiber with helical wire	2-ply fiber with helical wire
Cover	Pin-pricked PVC	EPDM rubber	Pin-pricked Nitrile blend	Pin-pricked Nitrile blend	EPDM	EPDM	EPDM	Corrugated EPDM	EPDM	EPDM	EPDM
Hose I.D. - Maximum recommended operating pressure - PSI											
3/16											
1/4	300	275	200	300	300	200					
5/16											
3/8	300	275	200	300	300	200					
13/32											
7/16											
1/2	300	250	200	300	300	200					
5/8	300	250		300	300	200					
3/4	300	250	225	300	225	300	300		500		
7/8											
1	250	250		300	200		300	300	500	250	
1-1/8											
1-1/4	150	250			200		300	300	500	250	
1-1/2	150	250			200		300	300	500	250	150
1-3/8											
1-3/16											
2	125						300	300	500	250	150
2-3/8											
2-1/2							300				
3							250	250	500	175	150
Hose fittings											
Crimp	E Series, Z Series, P Series	Z Series	Z Series	Z Series	Z Series	Z Series	—	—	—	—	—
Field Attach.	—	—	—	—	—	—	—	—	—	—	—

*Listing may vary by hose style and size, some hoses may require firesleeve or special procedures depending on specific applications. Contact Eaton for details.

INDUSTRIAL HOSE (continued)											
HOSE	Chemical Hose (continued)			Food and Beverage Hose						Liquefied Petroleum Gas	
	H0346	H1941	H1942	H0350	H285	PT200	H1066	H9673	H9610	H900	EH920
Page	D-3	D-3	D-3	D-4	D-4	D-4	D-4	D-4	D-4	D-5	D-5
Usage	Transfer of acids, chemicals, solvents, and petroleum products; loading and unloading, pumping, suction, or gravity flow discharge	Spraying pesticides and fertilizers; paint spray	Spraying pesticides and fertilizers; paint spray	Suction and discharge of non-dairy food products	Food and beverage dispensing; spraying and conveying fertilizer and pesticides	Food and beverage dispensing; spraying and conveying fertilizer and pesticides; low pressure laboratory, industrial, agricultural, or domestic application	Washdown of food processing facilities and equipment	Washdown of food processing facilities and equipment	Washdown of food processing facilities and equipment	Transfer and delivery of propane and butane; transfer of natural gas in open, well ventilated areas	Transfer and delivery of propane and butane; transfer of natural gas in open, well ventilated areas
Meets	—	—	—	FDA	NSF-51, FDA	NSF-51, FDA	—	—	—	—	—
SAE No.	—	—	—	—	—	—	—	—	—	—	—
Temp. Range °F	-45°F to +180°F	-30°F to +160°F	-30°F to +160°F	-40°F to +180°F	-15°F to +150°F	-5°F to +105°F	-40°F to +180°F	-40°F to +180°F	-40°F to +180°F	-40°F to +140°F	-40°F to +140°F
Inner Tube	EPDM	Nylon	Nylon	Vinyl Nitrile	Clear PVC	Clear PVC	Nitrile	Nitrile	Nitrile	Nitrile	Nitrile
Reinforcement	2-Ply fiber	1-Fiber braid	2-Fiber braid	2-Ply fiber with helical wire	2-Spiral fiber	—	2-Braid fiber	1- And 2-braid fiber	1-Braid fiber	Textile braid	Textile braids and stainless steel anti-static wire
Cover	EPDM	Neoprene (BK); Vinyl Nitrile and RMA Class B oil resistant (RD)	Neoprene (BK); Vinyl Nitrile and RMA Class B oil resistant (RD)	Vinyl Nitrile	Clear PVC	Clear PVC	Pin-Pricked Vinyl Nitrile	Vinyl Nitrile	Vinyl Nitrile	Pin-pricked Vinyl Nitrile	Pin-pricked Neoprene
Hose I.D. - Maximum recommended operating pressure - PSI											
3/16					250						
1/4		500			250	65				350	
5/16		500			250	55					
3/8		500			225	55		1250	1000	350	
13/32											
7/16											
1/2		500	750		200	45		1250	1000	350	
5/8					200	30					
3/4			750		150	40	200	1250	1000	350	
7/8											
1			500		125	35				350	
1-1/8											
1-1/4					100						
1-1/2	150				100						
1-3/8											
1-3/16											
2	150			250	75						350
2-3/8											
2-1/2											
3	100			250							
Hose fittings											
Crimp	—	E Series	—	—	E Series, 265 P Series	—	—	—	Z Series	—	—
Field Attach.	—	—	—	—	—	—	—	—	—	—	—

*Listing may vary by hose style and size, some hoses may require firesleeve or special procedures depending on specific applications. Contact Eaton for details.

Hose selection

Hose selection chart

For complete information on any hose refer to hose catalog page number.

A

INDUSTRIAL HOSE (continued)										
HOSE	Material Handling							Oil and Gas Exploration		Petroleum
	H0347	H0319	H0521	H0349	H0034	EHK006	EHK007	H0377	EHP009	H6009
Page	D-6	D-6	D-6	D-6	D-6	D-6	D-6	D-7	D-7	D-7
Usage	Transfer of dry bulk; discharge or abrasive material; Transfer of bottle caps; Transfer of cleaning agents	Transfer of dry bulk; discharge or abrasive material; Transfer of bottle caps; Transfer of cleaning agents	Transfer of dry bulk; discharge or abrasive material; Transfer of bottle caps; Transfer of cleaning agents	Hot air blower hose; hot, dry, non-oily applications	Conveys sand or shot for cleaning purposes	High pressure concrete pumping	High pressure concrete pumping; Heavy duty construction for applications needing long lasting durability	Rotary drilling	Transfer applications	Air-operated construction equipment
Meets	—	—	—	—	—	ASME B30.27-2014	ASME B30.27-2014	—	—	—
SAE No.	—	—	—	—	—	—	—	—	—	—
Temp. Range °F	-10°F to +160°F	-40°F to +158°F	-40°F to +158°F	-30°F to +300°F	-40°F to +158°F	-40°F to +158°F	-40°F to +158°F	-40°F to +158°F	-22°F to +176°F	-40°F to +250°F
Inner Tube	Static dissipating natural rubber/SBR	3/16" Tube thickness natural rubber blend	1/4" Tube thickness natural rubber blend	EPDM	Natural rubber	Natural rubber	Natural and CBR blend	Nitrile/Hypalon ¹ blend	Nitrile blend	Nitrile (RMA Class A)
Reinforcement	2-Ply fiber with dual helical wires	2-Ply textile and conductive copper anti-static wire	2-Ply textile and conductive copper anti-static wire	Textile with dual helical wires	4-Ply textile	High tensile synthetic textile and antistatic copper wire	High tensile steel cords	4-Spiral wire	High-tensile synthetic textile with dual steel helical wires	1"-1.25" 1-wire braid, 1.5"-3" 2-wire braid, 4" 3-wire braid
Cover	SBR	NR Blend	SBR	Pin-pricked EPDM	SBR	Pin-pricked synthetic rubber	Pin-pricked synthetic rubber	Neoprene	Corrugated SBR blend	Pin-Pricked Carboxylated Nitrile
Hose I.D. - Maximum recommended operating pressure - PSI										
3/16										
1/4										
5/16										
3/8										
13/32										
7/16										
1/2					150					
5/8										
3/4					150					
7/8										
1					150	1233				1000
1-1/8										
1-1/4					125	1233				800
1-1/2					100	1233			150	600
1-3/8										
1-3/16										
2					100	1233	1233	3000	150	600
2-3/8										
2-1/2						1233	1233		150	600
3	100			150		1233	1233		150	600
Hose fittings										
Crimp	—	—	—	—	—	—	—	—	—	Z Series
Field Attach.	—	—	—	—	—	—	—	—	—	—

¹ Hypalon® is a registered trademark of E.I. du Pont.

*Listing may vary by hose style and size, some hoses may require firesleeve or special procedures depending on specific applications. Contact Eaton for details.

INDUSTRIAL HOSE (continued)												
HOSE	Petroleum Hose				Specialty					Steam Hose		
	H1193	H0363	EHP150	H901	H0372	H0616	H9603	H9690	H8811	EH084	H0084	H9568
Page	D-7	D-7	D-7	D-7	D-8	D-8	D-8	D-8	D-8	D-9	D-9	D-9
Usage	Transfer of petroleum products; B20 biodiesel applications	Suction and discharge of petroleum products	Suction and discharge of petroleum products	Fuel oil transfer	Suction and discharge of tar and asphalt	Suction and discharge of tar and asphalt	Hot tar projects	Hydrocarbon drain service	Transfer of nitrogen at ambient temperatures	Transfer of steam for processing products and cleaning equipment	Transfer of steam for processing products and cleaning equipment	Transfer of steam for processing products and cleaning equipment
Meets	—	—	—	—	—	—	—	—	—	—	—	—
SAE No.	—	—	—	—	—	—	—	—	—	—	—	—
Temp. Range °F	-20°F to +180°F	-40°F to +180°F	-31°F to +158°F	-40°F to +180°F	+350°F Intermittent	+350°F Intermittent	+350°F Intermittent	-40°F to +350°F	-40°F to +180°F	-40°F to +407°F	Maximum Operating +450°F	Maximum Operating +450°F
Inner Tube	Nitrile Blend	Vinyl Nitrile Blend	NBR Blend (RMA Class A)	Nitrile Rubber (RMA Class A)	Nitrile	Nitrile	Nitrile (RMA Class A)	Nitrile (RMA Class A)	Nitrile	Special Chlorobutyl Blend	Special Chlorobutyl Blend	EPDM
Reinforcement	100% Polyester and helical wire	2- or 4-ply fiber with dual helical wires and anti-static copper wire	High-tensile synthetic textile, single steel helical and anti-static copper wire	Double fiber braid	2-Ply fiberglass with helical wire	2-Ply fiberglass with helical wire	2-Wire braid	2-Wire braid	4-Spiral fiber	2-Wire braid	2-Wire braid with stainless steel anti-static wire	2-Wire braid
Cover	Nitrile blend	Vinyl Nitrile blend	Abrasion and Weather Resistant NBR blend (RMA Class A)	Vinyl Nitrile rubber	Neoprene	Corrugated Neoprene	Pin-pricked CPE	Pin-pricked Chlorinated Polyethylene	Pin-pricked Neoprene	Pin-pricked EPDM	Pin-pricked EPDM	Pin-pricked EPDM
Hose I.D. - Maximum recommended operating pressure - PSI												
3/16												
1/4												
5/16												
3/8												
13/32												
7/16												
1/2										250		250
5/8												
3/4		150	150					300	300	250		250
7/8												
1		150	150	250			250			250		250
1-1/8												
1-1/4		150	150	250							250	
1-1/2	300	150	150	250							250	
1-3/8												
1-3/16												
2	300	150	150		200	200					250	
2-3/8												
2-1/2												
3	250	150	150		200							
Hose fittings												
Crimp	—	—	—	—	—	—	—	EJ Series	NA	EJ Series	—	EJ Series
Field Attach.	—	—	—	—	—	—	—	—	—	—	—	—

*Listing may vary by hose style and size, some hoses may require firesleeve or special procedures depending on specific applications. Contact Eaton for details.

Hose selection

Hose selection chart

For complete information on any hose refer to hose catalog page number.

A

HOSE	INDUSTRIAL HOSE (continued)							AC & REFRIGERATION			TRANSPORTATION	
	Water							AC			Synflex Air Brake	
	H1196	H0364	EHW150	EHW028	EHW029	FC701	FC702	GH001	FC800	H757	15CA	3SCE
Page	D-10	D-10	D-10	D-10	D-10	D-10	D-10	E-3	E-5	E-4	F-5	F-5
Usage	Transfer of water, liquid, diluted fertilizers, and pesticides	Pumping, suction, and discharge of water, mud, and slurries; diluted agricultural fertilizers; water apps	Pumping, suction, and discharge of water, mud, and slurries; diluted agricultural fertilizers; water apps	High pressure air in mines	Water discharge	High-pressure sewer cleaning	High-pressure sewer cleaning	Air cond. R134a, R1234yf, R404a, R407C, R410	Air cond. R134a, R1234yf, R407C, R22	Air cond. R12, R134a	Eclipse® Air brake line systems	Air brake line systems
Meets	MSHA	—	—	—	—	—	—	—	—	—	DOT-FMVSS 106	DOT-FMVSS 106
SAE No.	—	—	—	—	—	—	—	J2064 Type E	J2064	J2064 Type C Class 1	J844 Type B	J844 Type B
Temp. Range °F	-20°F to +180°F	-40°F to +248°F	-13°F to +158°F	-31°F to +212°F	-40°F to +248°F	-40°F to +150°F	-40°F to +150°F	-40°F to +284°F	-40°F to +257°F	-22°F to +248°F (for R12) -22°F to +257°F (for R134a)	-65°F to +200°F	-65°F to +200°F
Inner Tube	Thermoplastic Vinyl Nitrile	EPDM	Synthetic rubber	Oil-mist resistant NBR blend	EPDM	Blue Elastomer tube	Blue Elastomer tube	Dual extrusion technology polyamide Type E veneer	Chloroprene (CR)	Rubber	Eclipse® 100% Polyamide	Eclipse® 100% Polyamide
Reinforcement	100% Polyester and helical wire	High-tensile synthetic textile and steel helical wire	Textile and a single steel helical wire	High-tensile steel wire	High-tensile synthetic textile	Single braid, high strength textile	Single braid, high strength textile	Textile braid	1 wire braid	1 textile braid	Polyester yarn	Polyester yarn
Cover	Thermoplastic Vinyl Nitrile	EPDM	Oil Resistant NBR blend (RMA Class A)	MSHA Pin-pricked Neoprene blend	EPDM	Orange Ether-Based Polyurethane	Blue Ether-Based Polyurethane	Blended EPDM	EPDM	Butyl perforated	—	—
Hose I.D. - Maximum Recommended Operating Pressure - PSI												
3/16												
1/4												300
5/16								500		400		
3/8								500				
13/32										400		
7/16												
1/2				1000				500		350	238	
5/8								500		350		
3/4				1000		2500	3000	500	500			
7/8												
1				1000		2500	3000	500	500			
1-1/8												
1-1/4		150	150	1000	150	2500			500			
1-1/2	300	150	150	1000	150				500			
1-3/8												
1-13/16												
2	300	150	150	1000	150							
2-3/8												
2-1/2												
3	250	150	150		150							
Hose Fittings												
Crimp	—	—	—	—	—	—	—	E Series	—	757 E Series	—	—
Field Attach.	—	—	—	—	—	—	—	E-Z Clip	FC800	—	—	—

*Listing may vary by hose style and size, some hoses may require firesleeve or special procedures depending on specific applications. Contact Eaton for details.

TRANSPORTATION (continued)												
	Synflex Air Brake Tubing (cont.)			Synflex Diesel Fuel Tubing			Engine and Air Brake Hose					
HOSE	4245	4247	3270	4294	4297	4KGEN	EC038	H069	H166	H169	H213	H229
Page	F-6	F-7	F-8	F-9	F-10	F-11	F-12	F-13	F-15	F-15	F-16	F-17
Usage	Truck and trailer air brake systems; auxiliary air systems	Truck and trailer air brake systems; auxiliary air systems	Truck and trailer air brake systems; auxiliary air systems	Diesel fuel applications	Diesel fuel applications	Modification or repair of OEM fuel systems using Synflex 4294 or 4297 series fuel tubing	Air brake	Truck and hydraulic	High temperature truck	Hydraulic	High temperature truck	Air and hydraulic
Meets	DOT-FMVSS 106	DOT-FMVSS 106	DOT-FMVSS 106	ASTM D471, 0624, 0638, D648, 0709, 0746, 0742, 02240	ASTM D471, 0624, 0638, D648, 0709, 0746, 0742, 02240	—	DOT/FMVSS 106 Type All	DOT All	DOT All	—	DOT All	DOT All
SAE No.	J844 Type A, J1131, J2494-3	J844 Type A, J1131, J2494-3	J844 Type B, J1131, J2494-3	J844, J1131, J1394	J844, J1131, J1394	—	J1402	100R5, J1402 Type II	J1402 Type All	—	J1402 Type All	J1402 Type All
Temp. Range °F	-65°F to +200°F	-65°F to +200°F	-65°F to +200°F	-40°F to +200°F	-50°F to +250°F	—	-40°F to +212°F	-40°F to +212°F (Hyd.) -40°F to +200°F (Air brake) -40°F to +250°F (Hot oil)	-40°F to +250°F (Hyd.) -40°F to +200°F (Air brake)	-40°F to +212°F	-40°F to +200°F (Air brake) -50°F to +302°F (Hot oil)	-40°F to +212°F (Hyd.) -40°F to +212°F (Air brake)
Inner Tube	Eclipse® 100% Polyamide	Solstice® 100% Polyamide	Eclipse® 100% Polyamide	Nylon 12	Nylon 11	—	EPDM	Nitrile	Nitrile	Nitrile	CPE	Nitrile
Reinforcement	Polyester yarn	Polyester yarn	Polyester yarn	Thermoplastic	Thermoplastic Elastomer	—	1 textile braid	1 textile & 1 single wire braid	1 textile & 1 S.S. braid	1 textile & 1 single wire braid	1 single wire braid	1 textile braid
Cover	—	—	—	—	—	—	EPDM	Textile braid	Textile braid	Neoprene	Textile braid	Textile braid
Hose I.D. - Maximum Recommended Operating Pressure - PSI												
3/16								3000	1500	3000	2000	225
1/4	300	300					225	3000	500	3000	1500	
5/16	250							2250	500	2250	1500	225
3/8			350	75	50		225					
13/32								2000	500	2000	1250	225
7/16												
1/2			238	75	50		225	1750	450	1750	1000	225
5/8			225	75	50			1500	450	1500	750	225
3/4			200									
7/8								800	250	800	400	225
1												
1-1/8								625	250	625		
1-1/4												
1-1/2												
1-3/8								500		500		
1-13/16								350		350		
2												
2-3/8								350				
Hose Fittings												
Crimp	—	—	—	—	—	—	—	069 E Series	069 E Series	069 E Series	069 E Series, 229 P Series	069 E Series, 229 P Series
Field Attach.	Brass	Brass	—	—	—	—	—	069 D Series, 247 N Series	069 D Series, 247 N Series	069 D Series, 247 N Series	213 N Series	069 D Series, 247 N Series

*Listing may vary by hose style and size, some hoses may require firesleeve or special procedures depending on specific applications. Contact Eaton for details.

Hose selection

Hose selection chart

A

TRANSPORTATION											
	Engine and Air Brake Hose (Continued)			Diesel and Biodiesel Hose		Fuel Line Hose			Silicone Hose		
HOSE	H239	H429	H569	GH100	GH101	H057	H059	35FH	EH225	EH226	EH227
Page	F-18	F-18	F-19	F-20	F-21	F-22	F-23	F-23	F-24	F-25	F-26
Usage	Transmission oil cooler, diesel fuel, air brake	Transmission oil cooler, fuel and diesel lines	A/B and hydraulic	Diesel and biodiesel; low pressure oil applications	Diesel and biodiesel; low pressure oil applications	Fuel and oil	Fuel oil/Lube	Fuel	Engine	Engine	Engine
Meets	DOT All	—	DOT All *ABS	ASTM D380, ASTM D6751, EN412, EN2240	ASTM D380, ASTM D6751, EN412, EN2240	—	NMMA, *USCG	EPA/CARB, Recreational Craft Directive, 94/25/EC	—	—	—
SAE No.	J1402 Type All	J1019	100R5 J1942/1 J1402 Type All	—	—	30R7	J1942/1	J1527B1-15, J30R6, J30R9, 30R11	J20R3 Class A	J20R1 Class A	J20R1 Class A
Temp. Range °F	-40°F to +302°F (Hot oil) -40°F to +200°F (Air brake)	-55°F to +302°F	-55°F to +302°F (Hyd. fluid) -40°F to +200°F (Air brake) -40°F to +212°F (Air)	-40°F to +302°F (Up to B20); -40°F to +257°F (Up to B100); -40°F to +320°F (Oil-Transmission)	-40°F to +302°F (Up to B20); -40°F to +257°F (Up to B100)	-40°F to +275°F	-40°F to +212°F	-40°F to +160°F	-65°F to +350°F	-65°F to +350°F	-65°F to +500°F
Inner Tube	CPE	CPE	CPE	Eaton Developed HNBR	Eaton Developed HNBR	Nitrile	Special blended Nitrile	PVDF	Silicone	Silicone	Silicone
Reinforcement	1 textile braid	1 wire braid	1 textile & 1 single wire braid	Aramid braid	Aramid braid	1 textile braid	1 single wire & Nomex ² braid	1 polyester & 1 wire braid	1-ply Polyester	4-ply Polyester	4-ply Aramid
Cover	Black textile braid	Textile braid	Blue textile braid	Textile braid	CPE	Hypalon ¹	CPE	Black PVC alloy	Silicone	Silicone	Silicone
Hose I.D. - Maximum Recommended Operating Pressure - PSI											
3/16	225		3000			50	500				
1/4			3000	400	400	50	500	175	400		
5/16			2250			50	500	175	300	1080	
3/8				400	400	50		175	250	1060	
13/32	225	250	2000				500				
7/16						35					
1/2	225	250	1750	400	400		500		250	872	
5/8	225		1500	350	350		500		250	797	
3/4				350					200	754	
7/8	225		800						200	732	
1							500		175	699	
1-1/8	225		625							658	
1-1/4										617	
1-1/2										521	
1-3/8										550	
1-13/16											
2										442	
2-3/8										400	
3										317	
Hose Fittings											
Crimp	069 E Series, 229 P Series	757 E Series, 057 P Series	069 E Series	327 E Series	327 E Series	—	069 E Series, 229 P Series	—	—	—	—
Field Attach.	—	—	247 N Series	—	—	057 B Series	247 N Series	Socketless	—	—	—

¹ Hypalon® is a registered trademark of E.I. du Pont.

² Nomex is a trademark of The Chemours Company FC, LLC.

*Listing may vary by hose style and size, some hoses may require firesleeve or special procedures depending on specific applications. Contact Eaton for details.

HOSE	TRANSPORTATION					TEFLON HOSE						
	Power Steering	LPG Hose		CNG Hose		Full Bore		Everflex Reduced Bore			Convuluted	
	H324	H366	H900	NG-TW	35NG	H243	H277	S-Series	SC-Series	HI-PSI Series	8000 Series	8500 Series
Page	F-27	F-28	F-28	F-29	F-30	G-3	G-4	G-5	G-6	G-7	G-8	G-8
Usage	Passenger car/light truck power steering hose	Medium pressure LP gas service	Transfer and delivery of propane and butane	Low pressure CNG applications on equipment or vehicles	CNG Transfer & refueling dispenser lines, high press. on-vehicle lines	Hyd, air, steam, compressor discharge, chemical transfer, marine	Hyd, air, steam, compressor discharge, chemical transfer, marine	Hyd, air, steam, compressor discharge, chemical transfer, marine	Hyd, air, steam, compressor discharge, chemical transfer, marine	Hyd, air, steam, compressor discharge, chemical transfer, marine	Hyd, air, steam, compressor discharge, chemical transfer, marine, presses, RO	Hyd, air, steam, compressor discharge, chemical transfer, marine, presses, RO
Meets		MH 6776, ULMH 10198	UL 21	ANSI/CSA NGV4.2-2014, CSA 12.52-2014, ANSI/CSA NGV 3.1-2014/CSA 12.3-2014, ECE R110	ANSI/CSA NGV4.2-2014, CSA 12.52-2014, ANSI/CSA NGV 3.1-2014/CSA 12.3-2014	FDA	FDA	FDA	FDA	FDA	—	—
SAE No.	—	—	—	—	—	—	—	100R14 Type A	100R14 Type B	100R14 Type B	100R14 Type A	100R14 Type B
Temp. Range °F	-40°F to +250°F	-40°F to +300°F	-40°F to +140°F	-40°F to +248°F	-40°F to +185°F	-65°F to +450°F	-65°F to +450°F	-65°F to +450°F	-65°F to +450°F	-65°F to +450°F	-65°F to +400°F	-65°F to +400°F
Inner Tube	Nitrile	Nitrile	Nitrile	Static-dissipating Teflon	Conductive nylon core	Non-conductive Teflon	Conductive black Teflon	Non-conductive Teflon	Conductive black Teflon	Heavy wall conductive black Teflon	Convuluted non-conductive Teflon	Convuluted conductive black Teflon
Reinforcement	2 textile braids	1 textile braid, 1 stainless steel braid	Textile braid (1" has 2 stainless steel static wires)	304 stainless steel wire braid	Synthetic fiber	1-layer stainless braid (-16 only)	1-layer stainless braid (-16 only)	—	—	1-layer stainless braid (-12 through -24)	—	—
Cover	Neoprene	Textile braid	Vinyl Nitrile, Pin-pricked	Fire resistant black/Polyester blend cover, blue tracer	Black perforated polyurethane	1-layer stainless braid	1-layer stainless braid	304 or 316 stainless braid	1-layer stainless braid	1 or 2 layers of 304 stainless braid	304 stainless braid	304 stainless braid
Hose I.D. - Maximum Recommended Operating Pressure - PSI												
3/16						3000	3000	3500	3500			
1/4			350		5000	3000	3000	3000	3000	5000		
5/16						2500	2500	3000	3000			
3/8	1125	350	350	435	5000	2000	2000	2500	2500	5000		
13/32												
7/16												
1/2		350	350	435	5000	1750	1750	2000	2000	5000	1500	1500
5/8				435				1750	1750	5000		
3/4			350			1000	1000	1500	1500	5000	1250	1250
7/8												
1			350			1000	1000	1000	1000	5000	900	900
1-1/8												
1-1/4								1000		5000	900	900
1-1/2										4000	750	750
1-3/8												
1-13/16												
2											500	500
Hose Fittings												
Crimp	—	069 E Series	—	Must be TUV certified to crimp assemblies	Must be TUV certified to crimp assemblies	E Series	E Series	Everswage	Everswage	Factory Crimp only	Conv-O-Crimp	Conv-O-Crimp
Field Attach.	—	069 O Series, 247 N Series	—	E-HOTH-TT001-E for fitting and certification information	E-HOTH-TT001-E for fitting and certification information	—	—	—	—	—	—	—

Teflon is a trademark of The Chemours Company FC, LLC used under license by Eaton.

*Listing may vary by hose style and size, some hoses may require firesleeve or special procedures depending on specific applications. Contact Eaton for details.

Hose selection

Flow rate

A

There are several factors which affect selection of a hose sized such that it will provide the desired rate of flow at the required pressure; these are:

- Hose size
- Hose length
- Hose fittings
- Material conveyed
- Bends
- Static head pressure

Hose Size

Undersized pressure lines produce excessive pressure drop with attendant energy loss and heating, and undersized suction lines cause cavitation at the pump inlet. Oversized hose assemblies, on the other hand, are excessively costly and generally too heavy.

In selecting hose for hydraulic systems, the following empirical values can be used to achieve minimum pressure drop consistent with reasonable hose size (see Chart 2):

Velocity of pressure lines 7 to 15 ft./sec. Velocity of short pressure lines to 20 ft./sec. Velocity of suction lines 2 to 5 ft./sec. To use Chart 2, lay a straight-edge across the chart as shown by the dotted line. To minimize pressure drop, always use the next larger size hose shown if the line passes between sizes listed.

Hose Length

Chart 1 gives the pressure drop in different-sized hoses based on hoses of 100-foot length, and is based on water as the material conveyed. For hoses of a different length, these values must be corrected. For example, a 100-foot length of 1/2" hose causes a pressure drop of 100 lbs./in.² at a flow rate of 10 gal./min. If the hose in question is 50 feet long, the pressure drop derived from Chart 1 must

be corrected by multiplying the value by the ratio of the actual length to 100 feet, or 50/100, or 0.5. Therefore, the actual pressure drop caused by a 50-foot length of 1/2" hose, at a flow rate of 10 gal./min. is 50 lbs./in.² (0.5 x 100 = 50 lb./in.²).

Hose Fittings and Fluid Conveyed

In most cases, the end fitting openings are slightly smaller than the hose itself. However, this varies widely with hose fitting designs from 'full-flow' ends which have the same I.D. as the hose, down to as much as 1/8" smaller I.D. than the hose bore. To allow for this, assume a 10-to-15% greater flow rate than actually measured in the system when determining pressure drop.

Chart 1 is based on water as the material conveyed, and for other fluids it is necessary to correct for the difference in specific gravity and viscosity. Chart 3 lists common fluids, their specific gravities, viscosities, and corresponding correction factors. To determine the pressure drop for a specific fluid, first determine the pressure drop from Chart 1 for the hose length then divide this by the correction factor found in Chart 3. For example, the 50-foot length of 1/2" hose just described had a pressure drop of 50 lbs./in.² at a flow of 10 gal./min. of water. To determine the pressure drop if #2 fuel oil is the material conveyed, divide by 0.752 (from Chart 3) 50 ÷ 0.752 = 66.5 lbs./in.² pressure drop. If, on the other hand, the material conveyed is Type #3 gasoline, the pressure drop would be 50 ÷ 1.19 = 42 lbs./in.²



WARNING

Refer to safety information regarding tubing selection on pages A-2.

CHART 1. Hose Flow Rate vs. Pressure Drop

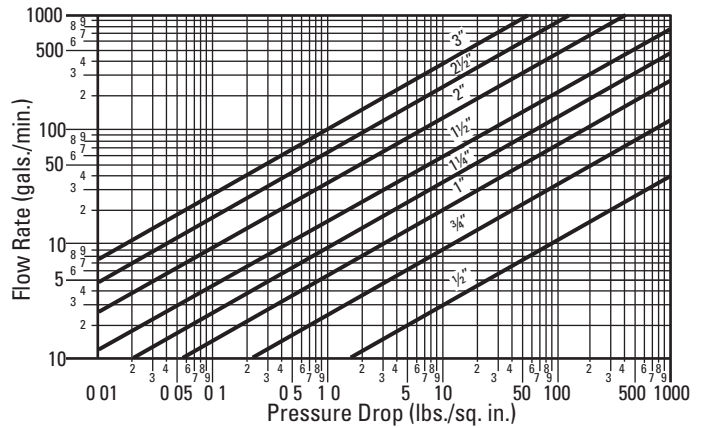
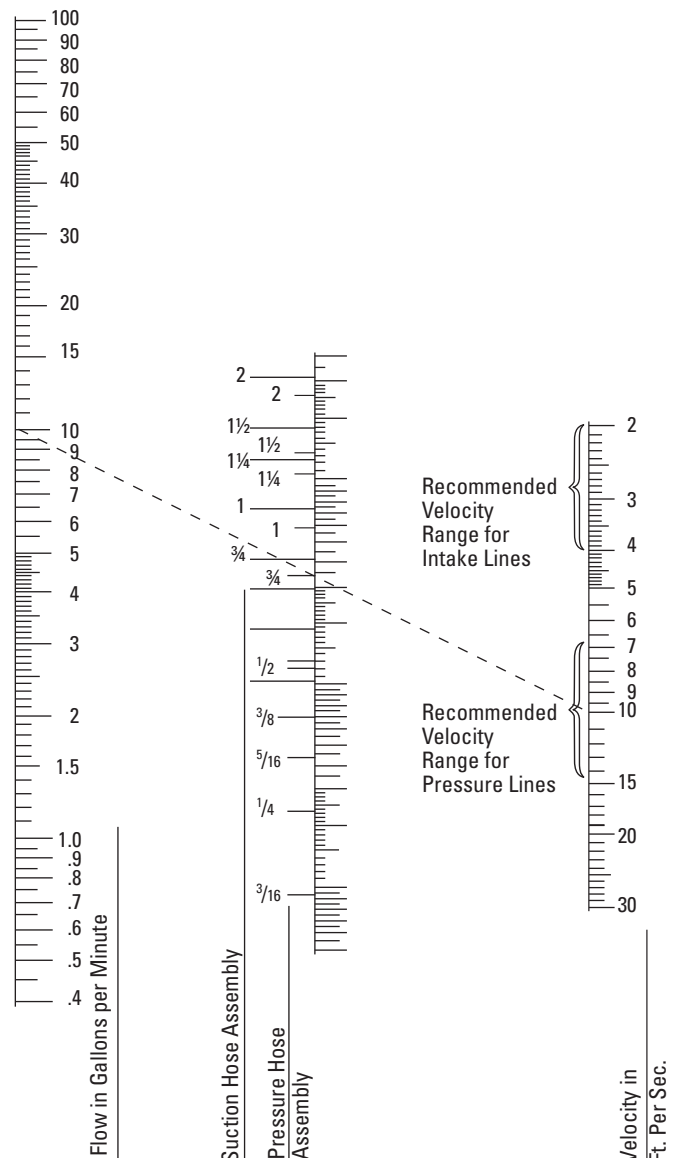

CHART 2. Hose Flow Capacity



⚠ WARNING

Refer to safety information regarding tubing selection on pages A-2.

CHART 3. Fluid Flow Correction Factors

Liquid	Specific Gravity	Viscosity Centistokes	Viscosity Centipoises	Correction Factor R.
	CS	CP		
Acetic Acid – 100%	1.05	–	1.3	0.975
Acetic Acid – 70%	1.07	–	2.7	0.843
Ammonia Liquid – 100%	0.66	0.30	–	1.290
Ammonia Liquid – 26%	0.907	–	1.3	0.943
Asphalt* @ 120°F	1.40	–	300.0	0.350
Beer*	1.01	1.15	–	0.990
Benzene Benzol	0.88	0.744	–	1.08
Brine Calcium Chloride – 25%	1.23	3.80	–	0.78
Brine Sodium Chloride – 25%	1.19	2.07	–	0.88
Butyl Alcohol	0.81	3.64	–	0.783
Castor Oil*	0.96	900.00	–	0.27
Crude Petroleum Typical*				
1. Pennsylvania Crude@100°F	0.80	–	3.0	0.78
2. California Crude @ 150°F	0.915	–	9.0	0.64
3. #33 API Crude @ 100°F	0.86	7.2	–	0.685
4. Texas Crude @ 150°F	0.875	–	3.0	0.792
5. Mexican Crude @ 150°F	0.96	–	550.0	0.287
Decane - n	0.73	1.24	–	0.975
Ethyl Alcohol @ 100°F	0.794	–	1.25	0.93
Ethyl Alcohol @ 95°F	0.808	–	1.45	0.904
Ethyl Alcohol @ 40°F	0.939	–	3.00	0.807
Ethyl Glycol	1.12	–	24.00	0.55
Formic Acid	1.22	–	–	0.94
Fuel Oils*				
No. 1 @ 100°F Sp Gr 82-95 Visc 30 to 40 SSU	0.88	2.45	–	0.85
No. 2 @ 100°F Sp Gr 82-95 Visc 35 to 50 SSU	0.88	4.50	–	0.752
No. 3 @ 100°F Sp Gr 82-95 Visc 55 SSU max	0.88	8.6	–	0.66
No. 5 @ 100°F Sp Gr 82-95 Visc 60 to 450 SSU	0.88	55.0	–	0.47
No. 6 @ 122°F Sp Gr 82-95 Visc 430 to 2900 SSU	0.88	38.0	–	0.493
Gasoline (representative)*				
Type #1	0.74	0.88	–	1.04
Type #2	0.72	0.64	–	1.11
Type #3	0.68	0.46	–	1.19
Glycerine (Glycerol) – 100% @ 150°F	1.26	–	75.0	0.45

* These figures are approximate or averages of those values available.

CHART 4. Resistance of 90° bends

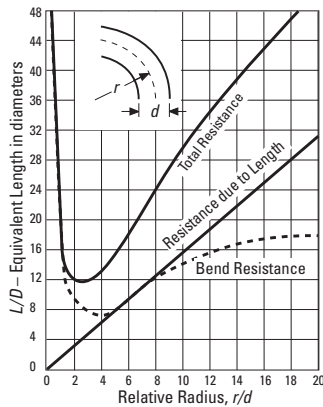

Bends

If a hose of a given length is bent, the pressure drop will increase by some definite amount...the sharper the bend and the smaller the radius of bend the greater the pressure drop. The effect of a bend may be neglected if it is slight or if there are but few bends in a long length of hose. This is because the additional pressure drop caused by these bends is not significant when compared to the total pressure drop.

However, a dock hose may have four sharp 90° bends in a 25-foot length, and if pressure drop is important, these bends must be considered because they constitute a significant portion of the overall pressure drop. The curves in Chart 4 show the effects of resistance due to 90° bends. This data can also be used as a guide for smooth bends less or greater than 90°. For example, a 45° bend has about 4/10 the resistance of a 90° bend.

Static head pressure

Static head is the difference in height between the inlet and outlet ends of a hose. Before using **Chart 1**, it is necessary to correct for static head pressure because the values in Chart 1 are pressure losses due to friction only. To correct for static head pressure, the difference in height is determined and multiplied by 0.433 to convert the head to an equivalent pressure in PSI (one foot of water exerts 0.433 PSI pressure).

If the inlet is higher than the outlet, the pressure equivalent is added to the pump pressure. If the outlet is higher than the inlet, the pressure equivalent is subtracted from the pump pressure. In both cases, it is assumed that the pump pressure is the pressure available at the inlet end and that the pump is outside of the hose system.

Installation design

Hose should not be twisted or put in torsion either during the installation or while in service. Sharp or excessive bends may cause the hose to kink or rupture. Be sure to allow enough slack to provide for changes in length which will occur when pressure is applied. This change in length can vary from +2% to -4%. Design the installation so the hose assembly is accessible for inspection and easy removal. Bend radius is important. A good working rule is that the minimum bend radius should be five or more times the O.D. dimension of the hose.

* In a continuous bend of 180 degrees the second 90 degree bend produces approximately one-half the resistance of the first bend.

Bend radius is important. A good working rule is that the minimum bend radius should be five or more times the O.D. dimension of the hose.

Problem: Determine the equivalent length, in terms of hose inside diameters, of a 90° and a 180° bend whose relative radii are 12 inches.

Solution: Referring to the "total resistance curve," the equivalent length for a 90° bend is 34.5 hose diameters. The equivalent length of a 180° bend is 34.5 diameters for one 90° bend, 18.7 diameters for resistance due to length, and 15.8 ÷ 2 diameters for bend resistance. Adding these 34.5, 18.7, and 15.8 ÷ 2 = 61.1 diameters for a 180° bend.* Note that this loss is less than the sum of losses through two 90° bends separated by tangents.

Hose selection

Hose fitting pressure charts

A

Thread style pressure performance

Eaton closely follows industry standards in design and in application recommendations. A key principle within ISO, SAE and other standards bodies is that the **maximum dynamic working pressure of the hose or adapter assembly** is the lesser of the hose and end connector(s) used.

The first table below provides excerpts from standard industry pressure rating charts for connector types as published by SAE (Society of Automotive Engineers).

Note 1: The tables below are applicable for low carbon free machining steels typically used in Fluid Power connections. For port type connections, the material and design of the port must be considered and may reduce expected strength.

Note 2: For high pressure applications Eaton recommends the use of more robust connector designs such as Code 62 flange or O-Ring face seal.

Note 3: Some Eaton products have higher pressure ratings. Refer to the product page for specific pressure ratings.

Selected SAE pressure ratings

Dash size	Inch size	37°	Pipe SAE J476	Male ORB SAE J1926 ORS adapt.	Male ORB SAE J1926 non-ORS adapt.	Adjustable SAE J1926 ORS	Adjustable ORB non-ORS	ORS	Inverted flare	Code 61 Flange	Code 62 Flange
-2	1/8	5000	5000	-	5000	-	5000	-	5000	-	-
-3	3/16	5000	-	9000	5000	6000	5000	-	5000	-	-
-4	1/4	4500	5000	9000	5000	6000	4500	9000	4500	-	-
-5	5/16	4000	-	9000	5000	6000	4500	9000	4000	-	-
-6	3/8	4000	4000	9000	5000	6000	4000	9000	4000	-	-
-8	1/2	4000	3000	9000	4500	6000	4000	9000	4000	5000	6000
-10	5/8	3000	-	9000	3500	6000	3000	6000	3000	-	-
-12	3/4	3000	2500	6000	3500	6000	3000	6000	3000	5000	6000
-14	7/8	2500	-	6000	3000	6000	2500	6000	2500	-	-
-16	1	2500	2000	6000	3000	5000	2500	6000	2500	5000	6000
-20	1 1/4	2000	1150	4000	2500	4000	2000	3600	2000	4000	6000
-24	1 1/2	1500	1000	4000	2500	3000	2000	3600	1500	3000	6000
-32	2	1125	1000	3000	2000	2500	1500	3000	1125	3000	6000

International pressure rating charts

Maximum working pressure (PSI)

Hose fitting connection	Hose fitting size									
	-04	-05	-06	-08	-10	-12	-16	-20	-24	-32
Male British Pipe (BSP)	5000	-	4000	4000	3500	4000	3500	2500	2,000	2000
Female British Pipe (BSP)	5000	-	4000	4000	3500	4000	3500	2500	2,000	2000
Female Pipe (JIS)	5000	-	5000	5000	-	4000	4000	-	-	-

Maximum working pressure (PSI)

Hose fitting Connection	Hose fitting size									
	-06	-08	-10	-12	-15	-18	-22	-28	-35	-42
DIN light	3625	3625	3625	3625	3625	2325	2325	1450	1450	1450

Hose fitting pressure charts

All Eaton components

With higher pressures it is critical to know the construction materials and manufacturing method to ensure performance. When all components in a system are Eaton supplied, for example an Eaton hose fitting is mated with an Eaton adapter or tube fitting, the combination may be used at higher pressures

with confidence. These higher ratings are noted in the chart below.

Maximum dynamic working pressure of the hose or adapter assembly is the lesser of the hose and end connector(s) used.

All Eaton pressure ratings¹

Dash Size	Inch Size	37° JIC	Male Pipe	Female Pipe ²	Male ORB ORS Adapters	Male ORB Non-ORS Adapters	Adjustable ORB ORS Adapters	Adjustable ORB Non-ORS Adapters	ORS	Male Flareless Ermeto	Code 61	Code 62	STC
-2	1/8	-	10000	6000	-	5000	-	5000	-	5000	-	-	-
-3	3/16	-	-	-	9000	5000	6000	5000	-	5000	-	-	-
-4	1/4	7000	9500	5000	9000	5000	6000	4500	9000	4500	-	-	6000
-5	5/16	7000	-	-	9000	5000	6000	4500	-	4000	-	-	-
-6	3/8	5000	8000	4000	9000	5000	6000	4000	9000	4000	-	-	5000
-8	1/2	4000	6000	4000	9000	4500	6000	4000	9000	4000	5000	6000	4250
-10	5/8	3800	-	-	9000	3500	6000	3000	9000	3000	-	-	4000
-12	3/4	5000	5000	3500	6000	3500	6000	3000	6000	3000	5000	6000	4000
-14	7/8	-	-	-	6000	3000	6000	2500	-	2500	-	-	-
-16	1	5000	4000	3000	6000	3000	5000	2500	6000	2500	5000	6000	4000
-20	1 1/4	5000	3000	2000	4000	2500	4000	2000	4500	2000	4000	6000	-
-24	1 1/2	2100	2000	1500	4000	2500	3000	2000	4000	1500	3000	6000	-
-32	2	1750	2000	1500	3000	2000	2500	1500	3000	1125	3000	6000	-

1) These ratings are based on both brazed and one piece construction, one-piece pressures could be increased. Please contact Eaton in these situations.

2) This rating is for thin walled adapters or fittings, the use of manifolds or oversized female ports would allow full rated male pressures.

Dynamic operating pressure

Dynamic operating conditions refers to cyclic pressure impulses, usually considered to be from near zero to the highest system pressure. Hydraulic standards typically represent these as square waves and expect a component to handle on the order of 200,000 to well over one million such cycles with a burst: operating safety factor of 4:1. The above charts are created with dynamic applications in mind. Most industrial and mobile hydraulic systems fit the dynamic operating pressure profile, for example hydraulic work circuits on construction equipment or on injection molding equipment.

Static operating pressure

Static operating conditions typically range from zero to operating pressure, but with far fewer cycles expected for the system life – perhaps 30,000 to 50,000 cycles and sharp pressure spikes are not expected, allowing a burst: operating safety factor of 3:1 or less. For static operating conditions, the Eaton ratings above can be safely increased by 25-30%. For example, a 3000 psi dynamic rated hose might be used in a 4000 psi static pressure application. Typical examples of static applications are water blast and hydraulic jacking.

Materials

The above tables represent performance using common low carbon steel material. Other materials and their

characteristics influence these ratings. Medium carbon steels or heat treated materials can support higher working pressures. Conversely non-ferrous materials such as aluminum or brass will have reduced capability – as much as 50%, or less, pressure handling capability. It is important to consider material properties in designing a system to ensure pressure rating compatibility of all materials.

Design & application

Eaton's Fluid Conveyance engineering and support teams have many decades of experience in designing, manufacturing and servicing hydraulic and other fluid conveyance systems globally. Eaton's product line is designed as a comprehensive

collection of hose, fittings, connectors, couplings and accessories that allow a system designer to select components to complete a fluid power system or a service technician to replace a component with confidence. The individual product specifications, the above pressure ratings and other technical information are intended as supporting guidelines for system design and service needs and are not to be construed as a guarantee of performance of the system or of individual Eaton components. Eaton provides comprehensive technical support so please call with questions about pressure needs not covered by these charts or for specific application support.

Hose selection

Fluid compatibility

A

Fluid compatibility

This chart indicates the suitability of various elastomers and metals for use with fluids to be conveyed. It is intended as a guide only and is not a guarantee. Final selection of the proper hose style, seal, or material of metal components is further dependent on many factors including pressure, fluid and ambient temperature, concentration, duration of exposure, etc.

How to use the chart

1. The chart has separate sections for rating elastomers for use as hose inner tubes and as seals. Ratings for a given elastomer may not always be the same in both sections.
2. Both the elastomer and the metal must be considered when determining suitability of a combination for a hose assembly, adapter with o-ring, swivel joint or coupling.
3. Locate the fluid to be conveyed and determine the suitability of the elastomeric and metal components according to the resistance ratings shown for each.
4. Refer to the inner tube materials groupings under "Hose tube identification".
5. Dimensional and operating specifications for each hose can be found on the catalog pages shown with each hose part number.
6. Information on o-rings and seal options for swivel joints and couplings, and how to specify them, are shown in the respective sections of this catalog.
7. For further details on the products shown in this catalog, and their applications, contact:

Eaton
 14615 Lone Oak Road,
 Eden Prairie, MN 55344
 USA
 952-937-9800
 Fax: 952-974-7722
 1-888-258-0222
 www.eaton.com

Seal elastomer data

Seal elastomer	Application specification	Max. operating temperature range
Buna-N†	none	-40°C to +121°C [-40°F to +250°F]
Neoprene	none	-54°C to +100°C [-65°F to +212°F]
EPR (Ethylene Propylene Rubber)/EPDM	none	-54°C to +149°C [-65°F to +300°F]
Viton*	MIL-R-25897	-29°C to +204°C [-15°F to +400°F]

†Buna-N temperature range -65°F to +225°F. Also per MIL-R-6855.

*Viton is a trademark of The Chemours Company FC, LLC.

Resistance key rating

- E** = Excellent – Fluid has little or no effect.
- G** = Good – Fluid has minor to moderate effect.
- C** = Conditional – Service conditions should be described to Eaton Weatherhead for determination of suitability for application.
- U** = Unsatisfactory

The differences between ratings "E" and "G" are relative. Both indicate satisfactory service. Where there is a choice, the materials rated "E" may be expected to give better or longer service than those rated "G".

NOTE: Special precautions are necessary in gaseous applications due to the potential volume of gaseous fluid in the system. Unless the cover is perforated, hose styles with rubber or thermoplastic covers are not suitable for gases above 250 psi. Hose styles with perforated covers are so noted in their construction descriptions.

⚠ WARNING: Compatibility of hose fittings with conveyed fluid is an essential factor in avoiding chemical reactions that may result in release of fluids or failure of the connection with the potential of causing severe personal injury or property damage.

Hose tube identification

1. Synthetic rubber
2. PTFE
3. Synflex thermoplastic elastomer
4. CPE
5. Special application hose (not included in fluid chart)
 - Fuel
 - LPG
 - Railroad air brake
 - Silicone
 - Truck air brake
 - A/C
6. EPDM rubber

The Fluid Compatibility chart is intended for reference use only.

The information in this chart pertains strictly to material compatibility and is not intended to be used as an application guide. For information on specific applications not included in this catalog, please contact Eaton Weatherhead.

Note 1 - Rubber-covered hose must be perforated to allow gas to escape.

Note 2 - Due to the widely different additives in these fluids, testing should be done on the actual fluid being considered.

Hose selection

Fluid compatibility

This chart is intended for reference use only.

The information in this chart pertains strictly to material compatibility and is not intended to be used as an application guide. For information on specific applications not included in this catalog, please contact Eaton Weatherhead.

*Viton is a trademark of The Chemours Company FC, LLC.

†Hytrell is a registered trademark of E.I. du Pont.

‡Monel is a registered trademark of Special Metals Corporation group of Companies.

Note 1 - Rubber-covered hose must be perforated to allow gas to escape.

Note 2 - Due to the widely different additives in these fluids, testing should be done on the actual fluid being considered.

Fluid	Synthetic rubber						Thermoplastic elastomer						Special application hose						Seals						Metal					
	PTFE		CPE		EPDM		Buna-N		Neoprene		EPR		Viton*		Urethane		Hytrell†		Steel		Brass		Stainless steel		Aluminum		Monel‡			
	1	2	3	4	5	6	1	2	3	4	5	6	1	2	3	4	5	6	1	2	3	4	5	6	1	2	3	4	5	6
Acetaldehyde	U	E	C	U	-	G	U	C	C	U	U	G	U	U	G	G	E	E	E	E	E	E	E	E	E	E	E	E		
Acetic acid, 10%	U	E	C	C	-	E	U	U	E	G	U	C	U	U	C	U	U	C	C	U	U	C	C	U	U	G	U	G		
Acetic acid, glacial	U	E	C	C	-	E	U	U	C	U	U	C	U	U	C	U	U	C	C	U	U	C	C	U	U	G	U	G		
Acetone	U	E	G	U	-	E	U	U	G	U	U	G	U	U	G	E	E	E	E	E	E	E	E	E	E	E	E	E		
Acetophenone	U	E	-	U	-	E	U	U	E	U	U	-	E	E	E	C	E	E	E	E	E	E	E	E	E	E	E	E		
Acetyl acetone	U	E	U	U	-	E	U	U	G	U	U	G	U	U	C	C	C	C	U	U	C	C	U	U	G	U	G	G		
Acetyl chloride	U	E	U	U	-	U	U	U	E	U	U	C	C	C	U	E	E	E	E	E	E	E	E	E	E	E	E	E		
Acetylene ¹	G	E	G	G	-	E	U	U	G	E	G	G	E	E	E	E	E	E	E	E	E	E	E	E	E	E	E	E		
Air, hot (up to +160°F) ¹	E	E	E	E	-	E	E	E	E	E	E	E	E	E	E	E	E	E	E	E	E	E	E	E	E	E	E	E		
Air, hot (161°F – 200°F) ¹	C	E	U	E	-	E	G	G	E	E	G	G	E	E	E	E	E	E	E	E	E	E	E	E	E	E	E	E		
Air, hot (201°F – 300°F) ¹	U	E	U	C	-	G	U	U	G	E	U	U	E	E	E	E	E	E	E	E	E	E	E	E	E	E	E	E		
Air wet, below 160°F ¹	E	E	C	E	-	E	E	E	E	E	G	C	U	G	E	E	E	E	E	E	E	E	E	E	E	E	E	E		
Aluminum chloride, 10% aq	E	E	E	E	-	E	E	E	E	E	G	E	U	U	U	U	U	U	U	U	U	U	U	U	U	U	U	U		
Aluminum fluoride, 10% aq	E	E	E	U	-	E	E	E	E	E	G	E	U	U	U	E	C	C	U	U	C	C	U	U	G	U	G	G		
Aluminum nitrate, 10% aq	E	E	E	C	-	E	E	E	E	E	E	E	U	U	C	C	C	C	U	U	C	C	U	U	G	U	G	G		
Aluminum sulfate, 10% aq	E	E	G	E	-	E	E	E	E	E	-	G	U	C	E	C	C	C	U	U	C	C	U	U	G	U	G	G		
Alums, 10% aq	E	E	E	E	-	E	E	E	E	E	E	E	U	C	E	C	C	C	U	U	C	C	U	U	G	U	G	G		
Ammonia, anhydrous ¹	C	U	U	C	-	E	E	E	E	U	-	-	E	U	E	E	E	E	E	E	E	E	E	E	E	E	E	E		
Ammonia, aqueous	G	G	U	C	-	E	E	E	E	U	-	-	E	U	E	E	E	E	E	E	E	E	E	E	E	E	E	E		
Ammonium carbonate, 10% aq	U	E	C	U	-	E	U	E	E	U	-	C	U	C	C	C	C	C	U	U	C	C	U	U	G	U	G	G		
Ammonium chloride, 10% aq	E	E	C	U	-	E	E	E	E	U	-	-	U	U	C	U	C	C	U	U	C	U	C	U	U	G	U	G	G	
Ammonium hydroxide, 10% aq	U	E	U	U	-	E	C	C	E	C	U	U	G	U	C	C	U	U	C	U	U	C	C	U	U	G	U	G	G	
Ammonium nitrate, 10% aq	E	E	C	U	-	E	E	G	E	U	G	C	G	U	G	G	U	U	C	U	U	C	C	U	U	G	U	G	G	

Resistance key rating

E = Excellent – Fluid has little or no effect.

G = Good – Fluid has minor to moderate effect.

C = Conditional – Service conditions should be described to Eaton Weatherhead for determination of suitability for application.

U = Unsatisfactory

Fluid	Synthetic rubber						Thermoplastic elastomer						Special application hose						Seals						Metal					
	PTFE		CPE		EPDM		Buna-N		Neoprene		EPR		Viton*		Urethane		Hytrell†		Steel		Brass		Stainless steel		Aluminum		Monel‡			
	1	2	3	4	5	6	1	2	3	4	5	6	1	2	3	4	5	6	1	2	3	4	5	6	1	2	3	4	5	6
Ammonium phosphate, 10% aq	E	E	C	U	-	E	E	E	E	-	G	C	U	C	G	U	C	G	U	G	U	G	U	G	U	G	U	G		
Ammonium sulfate/sulfide, 10% aq	E	E	C	U	-	E	E	E	E	U	G	C	U	U	G	U	U	G	U	G	U	G	U	G	U	G	U	G		
Amyl acetate	U	E	U	U	-	E	U	U	G	U	U	U	E	E	E	E	E	E	E	E	E	E	E	E	E	E	E	E		
Amyl alcohol	G	E	E	C	-	E	G	C	E	G	C	E	G	C	E	G	E	G	E	G	G	E	U	G	U	G	U	G		
Aniline, aniline oil	U	E	U	U	-	E	U	U	G	U	U	U	E	E	E	E	E	E	E	E	E	E	E	E	E	E	E	E		
Aniline dyes	U	E	U	U	-	E	U	G	G	G	U	U	U	C	G	C	G	C	U	U	C	G	C	U	U	G	U	G		
Asphalt, < 200°F	C	E	G	G	-	U	G	C	U	E	G	G	E	G	E	E	E	E	E	E	E	E	E	E	E	E	E	E		
IRM 901	E	E	E	E	-	U	E	E	C	E	E	E	E	E	E	E	E	E	E	E	E	E	E	E	E	E	E	E		
ASTM #2	E	E	E	E	-	U	E	G	U	E	G	E	E	E	E	E	E	E	E	E	E	E	E	E	E	E	E	E		
IRM 903	E	E	E	E	-	U	E	G	U	E	G	E	E	E	E	E	E	E	E	E	E	E	E	E	E	E	E	E		
Automatic trans. fluid ²	G	E	G	G	-	U	E	G	U	E	C	G	E	E	E	E	E	E	E	E	E	E	E	E	E	E	E	E		
Barium chloride, 10% aq	E	E	C	C	-	E	E	E	E	E	G	C	U	G	G	G	G	G	U	G	G	G	U	G	G	G	G	G		
Barium hydroxide, 105 aq	E	E	G	C	-	E	E	E	E	E	E	E	G	G	U	G	U	G	U	G	U	G	U	G	U	G	U	G		
Barium sulfide, 10% aq	E	E	C	C	-	E	E	E	E	E	G	C	U	G	G	U	G	U	G	U	G	U	G	U	G	U	G	U		
Benzene, benzol	U	E	U	U	-	U	U	U	U	E	U	C	G	E	E	E	E	E	E	E	E	E	E	E	E	E	E	E		
Benzoic acid	U	E	C	U	-	U	U	E	E	C	C	U	G	G	G	U	G	G	U	G	G	U	G	G	U	G	G	G		
Benzyl alcohol	U	E	C	U	-	E	U	G	G	E	C	C	E	G	E	G	E	E	E	E	E	E	E	E	E	E	E	E		
Biodiesel (<180°F)	G	E	G	C	-	U																								
Biodiesel (>180°F)	C	E	U	U	-	U																								
Black sulfate liquor	G	E	C	C	-	E	C	C	C	E	U	C	E	C	E	C	E	C	E	C	E	C	E	C	E	C	E	C		
Blast furnace gas	C	U	C	G	-	U	U	U	U	E	U	C	E	C	E	C	E	C	E	C	E	C	E	C	E	C	E	C		
Borax, 10% aq	E	E	G	C	-	E	G	G	E	E	G	E	E	E	E	E	E	E	E	E	E	E	E	E	E	E	E	E		
Boric acid, 10% aq	E	E	C	E	-	E	G	G	G	E	G	G	U	G	C	U	G	C	U	G	C	C	U	G	C	C	C	C		
Brine	G	E	C	C	-	C	E	G	E	E	G	C	U	G	G	U	G	G	U	G	G	U	G	G	U	G	G	U	E	
Bromine, dry	U	E	U	U	-	U	U	U	U	E	U	U	U	C	U	C	U	C	U	C	U	C	U	C	U	C	U	C	C	
Butane ¹	LPG approved hose only						-	E	C	U	E	-	-	E	E	E	E	E	E	E	E	E	E	E	E	E	E	E	E	
Butyl acetate	U	E	U	U	-	E	U	U	G	U	U	C	E	E	E	E	E	E	E	E	E	E	E	E	E	E	E	E	E	
Butyl alcohol	E	E	G	G	-	C	E	E	G	E	G	G	G	G	G	G	G	G	G	G	G	G	G	G	G	G	G	G	G	

A

Hose selection

Fluid compatibility

This chart is intended for reference use only. The information in this chart pertains strictly to material compatibility and is not intended to be used as an application guide. For information on specific applications not included in this catalog, please contact Eaton Weatherhead.

*Viton is a trademark of The Chemours Company FC, LLC.

†Hytrell is a registered trademark of E.I. du Pont.

‡Monel is a registered trademark of Special Metals Corporation group of Companies.

Note 1 - Rubber-covered hose must be perforated to allow gas to escape.

Note 2 - Due to the widely different additives in these fluids, testing should be done on the actual fluid being considered.

Fluid	Synthetic rubber						Thermoplastic elastomer						Special application hose						Seals						Metal					
	PTFE		CPE		EPDM		Buna-N		Neoprene		EPR		Viton*		Urethane		Hytrell†		Steel		Brass		Stainless steel		Aluminum		Monel‡			
	1	2	3	4	5	6	1	2	3	4	5	6	1	2	3	4	5	6	1	2	3	4	5	6	1	2	3	4	5	6
Butyl cellosolve	U	E	U	U	-	E	U	U	G	U	U	C	E	E	E	E	E	E	E	E	E	E	E	E	E	E	E	E	E	
Butylene (butene)¹	C	E	-	C	-	U	C	U	U	E	U	-	E	E	E	E	E	E	E	E	E	E	E	E	E	E	E	E	E	
Butyl stearate	U	E	-	U	-	U	G	U	U	E	-	-	G	G	G	G	G	G	G	G	G	G	G	G	G	G	G	G	G	
Butyraldehyde	U	E	-	U	-	E	U	U	G	U	U	-	E	E	E	E	E	E	E	E	E	E	E	E	E	E	E	E	E	
Calcium acetate, 10% aq	G	E	C	C	-	E	G	G	E	U	U	C	G	G	G	C	G	G	G	C	G	G	G	C	G	G	G	G	G	
Calcium bisulfate, 10% aq	U	E	C	G	-	U	E	E	U	E	G	G	U	C	C	U	U	U	U	U	U	U	U	U	U	U	U	U	U	
Calcium chloride, 10% aq	E	E	E	C	-	E	E	E	E	E	E	E	E	G	G	G	C	G	G	C	G	G	C	G	G	G	G	G	G	
Calcium hydroxide, 10% aq	E	E	C	C	-	E	E	E	E	E	U	C	G	G	G	U	G	G	U	G	U	G	U	U	U	U	U	U	U	
Calcium hydroxide, 10% aq	C	E	C	U	-	E	U	U	E	E	U	C	U	G	C	U	U	U	U	U	U	U	U	U	U	U	U	U	U	
Calcium nitrate, 10% aq	E	E	E	G	-	E	E	E	E	E	E	E	E	G	G	G	G	G	G	G	G	G	G	G	G	G	G	G	G	
Carbitol	G	E	G	C	-	G	G	G	G	G	U	G	E	E	E	E	E	E	E	E	E	E	E	E	E	E	E	E	E	
Carbolic acid (phenol)	U	E	U	U	-	C	U	U	G	E	U	U	U	E	E	U	U	U	E	-	-	-	-	-	-	-	-	-	-	
Carbonic acid	C	E	C	U	-	E	G	E	E	E	C	C	U	C	E	G	E	E	E	E	E	E	E	E	E	E	E	E	E	
Carbon dioxide, dry gas¹	E	E	E	E	-	E	G	G	E	E	G	E	E	E	E	E	E	E	E	E	E	E	E	E	E	E	E	E	E	
Carbon disulfide	U	E	U	U	-	U	U	U	U	E	C	C	G	G	G	E	G	G	G	G	G	G	G	G	G	G	G	G	G	
Carbon monoxide¹	E	E	E	E	-	E	G	G	E	E	G	E	E	E	E	E	E	E	E	E	E	E	E	E	E	E	E	E	E	
Carbon tetrachloride	U	E	U	U	-	U	U	U	U	E	U	U	U	G	G	U	E	E	E	E	E	E	E	E	E	E	E	E	E	
Castor oil	E	E	G	E	-	G	E	E	G	E	G	G	E	E	E	E	E	E	E	E	E	E	E	E	E	E	E	E	E	
Cellosolve acetate	U	E	U	U	-	E	U	U	G	U	U	U	U	U	E	G	E	E	E	E	E	E	E	E	E	E	E	E	E	
China wood oil (tung Oil)	E	E	C	C	-	U	G	G	U	E	U	C	E	G	E	E	E	E	E	E	E	E	E	E	E	E	E	E	E	
Chlorine¹	U	G	U	U	-	U	U	U	U	G	U	U	C	C	C	C	C	C	C	C	C	C	C	C	C	C	C	C	C	
Chloroacetic acid	U	E	U	U	-	E	U	U	G	U	U	U	U	U	U	U	U	U	U	U	U	U	U	U	U	U	U	U	U	

Fluid	Synthetic rubber						Thermoplastic elastomer						Special application hose						Seals						Metal					
	PTFE		CPE		EPDM		Buna-N		Neoprene		EPR		Viton*		Urethane		Hytrell†		Steel		Brass		Stainless steel		Aluminum		Monel‡			
	1	2	3	4	5	6	1	2	3	4	5	6	1	2	3	4	5	6	1	2	3	4	5	6	1	2	3	4	5	6
Chloroacetone	U	E	U	U	-	E	U	U	E	U	U	C	E	E	E	U	U	U	U	G	G	G	U	G	G	G	G	G		
Chlorobenzene	U	E	U	U	-	U	U	U	U	G	U	U	G	G	G	U	U	U	U	G	G	G	G	G	G	G	G	G	G	
Chloroform	U	E	U	U	-	U	U	U	U	E	U	U	G	G	G	U	U	U	U	G	G	G	G	G	G	G	G	G	G	
O-Chlorophenol	U	E	U	U	-	U	U	U	U	E	U	U	G	G	G	U	U	U	U	G	G	G	U	G	G	G	G	G	G	
Chlorosulfonic acid	U	U	U	U	-	U	U	U	U	U	U	U	U	U	U	U	U	U	U	G	U	G	G	C	G	G	G	G	G	
Chrome plating solution	U	E	-	U	-	U	U	U	G	E	U	-	C	U	U	U	U	U	C	U	U	U	U	U	U	U	U	U	U	
Chromic acid	U	E	-	U	-	C	U	U	C	E	U	-	C	U	U	U	U	U	C	U	U	U	U	U	U	U	U	U	U	
Citric acid	G	E	C	G	-	E	E	E	E	E	E	E	E	C	C	C	C	C	C	C	C	C	C	C	C	C	C	C	C	
Coke oven gas	U	E	-	U	-	U	U	U	U	E	U	-	E	C	E	U	U	U	U	E	C	E	U	U	U	U	U	U	U	
Copper chloride, 10% aq	E	E	E	G	-	E	E	E	E	E	G	E	U	U	U	U	U	U	E	U	U	U	U	U	U	U	U	U	U	
Copper cyanide, 10% aq	E	E	-	G	-	E	E	E	E	E	E	-	E	U	G	U	U	U	E	U	G	U	U	U	U	U	U	U	U	
Copper sulfate, 10% aq	E	E	G	G	-	E	E	E	E	E	G	G	U	C	G	U	C	G	U	C	G	U	G	U	G	U	G	U	G	
Cotton seed Oil	E	E	E	G	-	C	E	G	C	E	E	E	E	E	E	E	E	E	E	E	E	E	E	E	E	E	E	E	E	
Creosote (coal tar)	G	E	U	G	-	U	G	C	U	E	U	U	E	U	U	E	U	U	E	C	E	E	E	E	E	E	E	E	E	
Crude oil	G	E	C	E	-	U	E	G	U	E	G	C	G	U	G	C	G	U	G	U	G	U	U	U	U	U	U	U	U	
Cyclohexanol	C	E	C	G	-	U	E	G	U	E	C	C	E	E	E	C	C	E	E	E	E	E	C	E	E	E	E	E	E	
Cyclohexanone	U	E	C	U	-	G	U	U	G	U	G	G	E	E	E	C	E	E	E	E	E	E	C	E	E	E	E	E	E	
Detergent/ Water solution	E	E	C	G	-	E	E	E	E	E	C	C	G	E	E	E	E	E	E	G	E	E	E	E	E	E	E	E	E	
Diacetone alcohol (acetol)	U	E	U	U	-	E	U	U	E	U	C	C	E	E	E	E	E	E	E	E	E	E	E	E	E	E	E	E	E	
Dibenzyl ether	U	E	-	U	-	G	U	U	G	U	-	-	G	G	G	G	G	G	G	G	G	G	G	G	G	G	G	G	G	
Diesel oil ²	G	E	C	G	-	U	E	C	U	E	C	C	E	E	E	E	E	E	E	E	E	E	E	E	E	E	E	E	E	
Diethylamine	C	E	-	C	-	C	G	G	G	U	-	-	E	U	E	-	-	E	U	E	-	-	-	-	-	-	-	-	-	
Diethyl phthalate (DOP)	U	E	C	C	-	G	U	U	G	G	C	C	E	E	E	E	E	E	E	E	E	E	E	E	E	E	E	E	E	
Dowtherm A&E	U	E	-	U	-	U	U	U	U	E	-	-	G	U	E	E	E	E	E	E	E	E	E	E	E	E	E	E	E	
Ethyl alcohol (Ethanol)	E	E	C	G	-	E	E	E	E	E	C	C	E	E	E	E	E	E	E	E	E	E	E	E	E	E	E	E	E	
Ethyl acetate	U	E	C	U	-	G	U	U	G	U	C	C	E	E	E	E	E	E	E	E	E	E	E	E	E	E	E	E	E	
Ethyl benzene	U	E	-	U	-	U	U	U	U	E	U	-	E	G	G	G	E	E	E	E	E	E	E	E	E	E	E	E	E	
Ethyl cellulose	G	E	U	U	-	G	G	G	G	U	C	C	E	G	G	G	G	G	G	G	G	G	G	G	G	G	G	G	G	
Ethyl chloride	C	E	U	U	-	U	U	U	U	E	U	U	E	E	E	E	E	E	E	E	E	E	E	E	E	E	E	E	E	
Ethylene dichloride	U	E	U	U	-	U	U	U	U	G	U	U	G	C	G	U	U	G	C	G	G	G	G	G	G	G	G	G	G	
Ethylene glycol	E	E	C	G	-	E	E	E	E	E	C	C	U	G	E	E	E	E	E	E	E	E	E	E	E	E	E	E	E	

Resistance key rating

- E** = Excellent – Fluid has little or no effect.
- G** = Good – Fluid has minor to moderate effect.
- C** = Conditional – Service conditions should be described to Eaton Weatherhead for determination of suitability for application.
- U** = Unsatisfactory

This chart is intended for reference use only.

The information in this chart pertains strictly to material compatibility and is not intended to be used as an application guide. For information on specific applications not included in this catalog, please contact Eaton Weatherhead.

*Viton is a trademark of The Chemours Company FC, LLC.

†Hytrell is a registered trademark of E.I. du Pont.

‡Monel is a registered trademark of Special Metals Corporation group of Companies.

Note 1 - Rubber-covered hose must be perforated to allow gas to escape.

Note 2 - Due to the widely different additives in these fluids, testing should be done on the actual fluid being considered.

Fluid	Synthetic rubber						Thermoplastic elastomer						Special application hose						Seals						Metal					
	PTFE		CPE		EPDM		Buna-N		Neoprene		EPR		Viton*		Urethane		Hytrell†		Steel		Brass		Stainless steel		Aluminum		Monel‡			
	1	2	3	4	5	6	1	2	3	4	5	6	1	2	3	4	5	6	1	2	3	4	5	6	1	2	3	4	5	6
Ferric chloride, 10% aq	E	E	-	G	-	E	E	G	E	-	-	E	E	E	-	-	E	E	E	E	E	E	E	E	E	E	E	E	E	
Ferric nitrate, 10% aq	E	E	C	E	-	E	E	E	E	E	C	C	U	U	G	U	U	U	U	G	U	U	U	U	U	U	U	U	U	
Ferric sulfate, 10% aq	E	E	C	E	-	E	G	G	G	E	C	C	U	U	E	U	U	U	U	E	U	U	U	U	U	U	U	U	U	
Formaldehyde	U	E	C	U	-	E	C	C	G	G	C	C	E	E	E	G	G	E	E	E	G	G	E	E	G	G	E	E	E	
Formic acid	G	E	U	C	-	E	C	G	E	U	U	U	U	U	C	C	C	C	C	C	C	C	C	C	C	C	C	C	C	
Fuel oil	E	E	G	E	-	U	E	G	U	E	G	G	E	E	E	E	E	E	E	E	E	E	E	E	E	E	E	E	E	
Furfural	U	E	-	U	-	G	C	C	G	U	U	-	G	G	G	G	G	G	G	G	G	G	G	G	G	G	G	G	G	
Gallic acid, solution	G	E	-	C	-	G	G	G	G	E	U	-	U	-	G	C	G													
Gasoline ²	G	E	E	G	-	U	E	C	U	E	E	E	E	E	E	E	E	E	E	E	E	E	E	E	E	E	E	E	E	
Gasohol ²	G	E	G	C	-	U	G	G	U	E	E	E	E	E	E	E	E	E	E	E	E	E	E	E	E	E	E	E	E	
Glycerine/Glycerol	E	E	E	E	-	E	E	E	E	E	E	E	E	E	E	E	E	E	E	E	E	E	E	E	E	E	E	E	E	
Green sulfate liquor	G	E	-	U	-	E	G	G	E	E	-	-	U	U	E	U	U													
Helium¹	E	G	C	E	-	E	E	E	E	E	E	E	E	E	E	E	E	E	E	E	E	E	E	E	E	E	E	E	E	
Heptane	E	E	E	C	-	U	E	G	U	E	G	G	E	E	E	E	E	E	E	E	E	E	E	E	E	E	E	E	E	
Hexaldehyde	U	E	-	U	-	E	U	G	G	U	U	-	G	G	E	E	G													
Hexane	E	E	E	E	-	U	E	G	U	E	G	G	E	E	E	E	E	E	E	E	E	E	E	E	E	E	E	E	E	
Hydraulic oils ²																														
Ester blend	C	E	C	G	-	C	E	U	U	E	U	E	E	E	E	E	E	E	E	E	E	E	E	E	E	E	E	E	E	
Phos. Ester/petroleum blend	U	E	C	U	-	U	U	U	U	C	U	G	E	E	E	E	E	E	E	E	E	E	E	E	E	E	E	E	E	
Silicone oils	E	E	E	E	-	E	E	E	E	E	E	E	E	E	E	E	E	E	E	E	E	E	E	E	E	E	E	E	E	
Straight petroleum base	E	E	E	E	-	U	E	G	U	E	E	E	E	E	E	E	E	E	E	E	E	E	E	E	E	E	E	E	E	
Straight phosphate ester	U	E	C	U	-	E	U	U	G	C	U	G	E	E	E	E	E	E	E	E	E	E	E	E	E	E	E	E	E	
Water glycol	E	E	C	G	-	E	E	E	E	E	E	C	C	E	E	E	G	E												
Water petroleum emulsion	E	E	C	G	-	U	E	G	U	E	C	C	C	E	E	G	E													

Resistance key rating

- E** = Excellent – Fluid has little or no effect.
- G** = Good – Fluid has minor to moderate effect.
- C** = Conditional – Service conditions should be described to Eaton Weatherhead for determination of suitability for application.
- U** = Unsatisfactory

Fluid	Synthetic rubber						Thermoplastic elastomer						Special application hose						Seals						Metal					
	PTFE		CPE		EPDM		Buna-N		Neoprene		EPR		Viton*		Urethane		Hytrell†		Steel		Brass		Stainless steel		Aluminum		Monel‡			
	1	2	3	4	5	6	1	2	3	4	5	6	1	2	3	4	5	6	1	2	3	4	5	6	1	2	3	4	5	6
Hydrobromic acid	U	E	U	E	-	G	U	U	E	E	U	U	E	E	U	U	E	U	E	U	E	E	E	U	E	E	E	U	U	
Hydrochloric acid, cold	U	E	U	U	-	G	U	U	G	E	U	U	U	U	U	U	U	U	U	U	U	U	U	U	U	U	U	U	U	
Hydrocyanic acid	C	E	-	U	-	E	C	C	E	E	-	-	E	E	-	-	E	E	E	E	G	E	G	E	G	E	G	E	G	
Hydrofluoric acid	U	E	U	U	-	U	U	U	C	U	U	U	U	U	U	U	U	U	U	U	U	U	U	U	U	U	U	U	C	
Hydrofluorosilicic acid	E	E	-	G	-	G	G	G	E	E	-	-	U	U	U	U	U	U	U	U	U	U	U	U	U	U	U	U	U	
Hydrogen ¹	G	C	G	G	-	E	E	E	E	E	E	E	E	E	E	E	E	E	E	E	E	E	E	E	E	E	E	E		
Hydrogen peroxide	C	E	G	C	-	G	G	G	G	E	G	G	U	U	G	G	U	U	U	G	E	G	G	U	U	G	E	U		
Hydrogen sulfide, dry	C	C	C	U	-	E	U	G	E	U	-	G	E	G	G	U	U	G	G	G	G	G	U	U	G	G	G	G		
Isocyanate	U	E	U	U	-	U	U	U	G	E	U	U	U	U	U	U	U	U	U	G	-	G	-	-	-	-	-	-		
Iso octane	G	E	E	G	-	U	E	G	U	E	G	E	E	E	E	E	E	E	E	E	E	E	E	E	E	E	E	E		
Isopropyl acetate	U	E	C	U	-	C	U	U	G	U	U	C	E	-	E	E	E	E	E	E	E	E	E	E	E	E	E	E		
Isopropyl alcohol	G	E	C	G	-	E	G	G	E	E	U	C	E	E	E	G	E	E	E	E	E	E	E	E	E	E	E	E		
Isopropyl ether	G	E	-	C	-	U	G	U	U	U	C	-	G	G	G	-	-	-	-	-	-	-	-	-	-	-	-	-		
JP-4, JP-5	E	E	G	E	-	U	E	U	U	E	U	G	E	E	E	E	E	E	E	E	E	E	E	E	E	E	E	E		
Kerosene	G	E	G	E	-	U	E	U	U	E	U	G	E	E	E	E	E	E	E	E	E	E	E	E	E	E	E	E		
Lacquer/lacquer solvents	U	E	U	U	-	E	U	U	U	U	U	G	U	E	E	E	E	E	E	E	E	E	E	E	E	E	E	E		
Lime sulfur	U	E	C	U	-	E	U	E	E	E	C	C	G	U	G	-	U	U	U	G	-	U	-	-	-	-	-	-		
Linseed oil	E	E	G	G	-	U	E	G	U	E	G	G	E	E	E	E	E	E	E	E	E	E	E	E	E	E	E	E		
LPG ¹	LPG approved hose only						E	G	U	E	-	-	E	E	E	E	E	E	E	E	E	E	E	E	E	E	E	E		
Lubricating oils ²	See hydraulic oils						See hydraulic oils						See hydraulic oils																	
Magnesium chloride, 10% aq	E	E	C	E	-	E	E	E	E	E	C	C	E	C	C	E	C	C	C	C	C	C	E	C	C	G	G	G		
Magnesium hydroxide, 10% aq	G	E	C	G	-	E	G	G	E	E	C	C	E	G	E	G	E	G	E	E	E	E	C	C	E	G	E	G		
Magnesium sulfate, 10% aq	E	E	C	E	-	E	E	E	E	E	C	C	E	E	E	E	E	E	E	E	E	E	C	C	E	E	E	E		
Maleic acid	U	E	C	C	-	G	U	U	U	E	C	C	E	G	G	G	U	U	U	E	C	C	E	G	G	E	G	G		
Maleic anhydride	U	E	C	U	-	C	U	U	U	E	C	C	G	U	E	G	E	E	E	E	E	E	C	C	G	U	E	G		
Malic acid	G	E	-	G	-	U	G	G	U	G	-	-	U	-	E	G	E	E	E	E	E	E	E	U	U	U	U	U		
Mercuric chloride	G	E	E	G	-	G	E	E	E	E	E	E	E	U	U	U	U	U	U	U	U	U	U	U	U	U	U	U		
Mercury	E	E	E	E	-	E	E	E	E	E	E	E	E	E	E	E	E	E	E	E	E	E	E	U	U	U	U	U		
Methanol	E	E	C	E	-	E	G	G	E	U	C	C	G	G	E	C	E	E	E	E	E	E	U	C	C	G	E	C		

Hose selection

Fluid compatibility

This chart is intended for reference use only. The information in this chart pertains strictly to material compatibility and is not intended to be used as an application guide. For information on specific applications not included in this catalog, please contact Eaton Weatherhead.

*Viton is a trademark of The Chemours Company FC, LLC.

†Hytrell is a registered trademark of E.I. du Pont.

‡Monel is a registered trademark of Special Metals Corporation group of Companies.

Note 1 - Rubber-covered hose must be perforated to allow gas to escape.

Note 2 - Due to the widely different additives in these fluids, testing should be done on the actual fluid being considered.

Fluid	Synthetic rubber						Thermoplastic elastomer						Special application hose						Seals						Metal					
	PTFE		CPE		EPDM		Buna-N		Neoprene		EPR		Viton*		Urethane		Hytrell†		Steel		Brass		Stainless steel		Aluminum		Monel‡			
	1	2	3	4	5	6	1	2	3	4	5	6	1	2	3	4	5	6	1	2	3	4	5	6	1	2	3	4	5	6
Methyl bromide	C	E	U	U	-	U	G	U	U	E	U	U	E	U	U	E	U	U	E	E	G	U	E	E	E	U	E			
Methyl chloride	U	E	U	U	-	U	U	U	U	E	U	U	E	U	U	E	U	U	E	E	E	U	E	E	U	E	G			
Methyl butyl ketone	U	E	U	U	-	E	U	U	E	U	C	C	E	E	E	-	E	E	E	E	E	-	E	E	E	E	E			
Methyl ethyl ketone	U	E	U	U	-	E	U	U	E	U	U	G	G	G	G	G	G	G	G	G	G	G	G	G	G	G	G			
Methylene chloride	U	E	U	U	-	U	U	U	U	G	U	U	G	U	U	G	G	G	G	G	G	G	G	G	G	G	G			
Methyl isobutyl ketone	U	E	U	U	-	E	U	U	U	U	U	U	U	U	U	G	G	G	G	G	G	G	G	G	G	G	G			
Methyl isopropyl ketone	U	E	U	C	-	E	U	U	U	U	U	U	U	U	G	G	G	G	G	G	G	G	G	G	G	G	G			
Methyl salicylate	U	E	-	U	-	C	U	U	C	U	-	-	E	G	G	E	G	E	G	E	G	E	G	E	G	E	G			
MIL-L-2104	E	E	E	E	-	U	E	G	U	E	E	E	E	E	E	E	E	E	E	E	E	-	E	E	E	E	E			
MIL-H-5606	E	E	E	E	-	U	E	G	U	E	E	E	E	E	E	E	E	E	E	E	E	E	E	E	E	E	E			
MIL-H-6083	E	E	E	E	-	U	E	E	U	E	E	E	E	E	E	E	E	E	E	E	E	-	E	E	E	E	E			
MIL-L-7808	G	E	G	G	-	U	G	U	U	E	G	G	G	G	G	E	-	-	E	E	E	E	E	E	E	E	E			
MIL-L-23699	E	E	-	G	-	U	G	U	U	E	-	-	E	E	E	E	E	E	E	E	E	E	E	E	E	E	E			
MIL-H-46170	G	E	-	G	-	C	E	G	U	E	-	-	E	E	E	-	E	E	E	E	-	E	E	E	E	E	E			
MIL-H-83282	G	E	-	G	-	U	E	U	U	E	-	-	E	E	E	-	E	E	E	E	-	E	E	E	E	E	E			
Mineral oils	E	E	G	E	-	U	E	G	U	E	G	G	E	E	E	E	E	E	E	E	E	E	E	E	E	E	E			
Naphtha	C	E	G	E	-	U	C	U	U	E	C	G	-	-	-	-	-	-	-	-	-	-	-	-	-	-	-			
Naphthalene	U	E	U	U	-	U	U	U	U	E	C	G	E	G	E	G	E	G	G	G	G	G	G	G	G	G	G			
Naphthenic acid	U	E	-	U	-	U	C	U	U	E	-	-	-	G	E	G	E	G	G	G	G	G	G	G	G	G	G			
Natural gas ¹	LPG approved hose only						E	E	U	E	-	-	G	G	G	G	G	G	G	G	G	G	G	G	G	G	G	G		
Nickel acetate, 10% aq	G	C	U	G	-	E	C	C	E	G	U	U	G	C	E	G	E	G	E	G	E	G	E	G	E	G	E			
Nickel chloride, 10% aq	E	E	U	E	-	E	E	G	E	E	U	U	U	U	U	G	U	U	U	U	U	U	U	U	U	U	G			
Nickel sulfate, 10% aq	E	E	U	E	-	E	E	E	E	E	U	U	U	U	G	U	U	U	U	U	U	U	U	U	U	U	U			
Nitric acid, to 10%	U	E	U	U	-	G	U	U	U	E	U	C	U	U	E	U	U	U	U	U	U	U	U	U	U	U	U			
Nitric acid, over 10%	U	C	U	U	-	U	U	U	U	G	U	U	U	U	E	U	U	U	U	U	U	U	U	C	U	U	U			
Nitrobenzene	U	E	U	U	-	E	U	U	U	G	U	U	E	G	U	U	E	G	E	E	E	E	E	E	E	E	E			

Resistance key rating

- E** = Excellent – Fluid has little or no effect.
- G** = Good – Fluid has minor to moderate effect.
- C** = Conditional – Service conditions should be described to Eaton Weatherhead for determination of suitability for application.
- U** = Unsatisfactory

Fluid	Synthetic rubber						Thermoplastic elastomer						Special application hose						Seals						Metal					
	PTFE		CPE		EPDM		Buna-N		Neoprene		EPR		Viton*		Urethane		Hytrell†		Steel		Brass		Stainless steel		Aluminum		Monel‡			
	1	2	3	4	5	6	1	2	3	4	5	6	1	2	3	4	5	6	1	2	3	4	5	6	1	2	3	4	5	6
Nitrogen ¹	E	E	E	E	-	E	E	E	E	E	E	E	E	E	E	E	E	E	E	E	E	E	E	E	E	E	E			
Octyl alcohol	C	E	E	U	-	U	E	E	E	E	E	E	E	E	E	E	E	E	E	E	E	E	E	E	E	E	E			
Oleic acid	G	E	G	U	-	U	U	U	C	G	G	E	C	G	E	C	E	G	C	E	G	C	E	G	C	G	G			
Ortho-dichlorobenzene	U	E	-	U	-	U	U	U	U	E	-	-	G	G	G	G	G	G	G	G	G	G	G	G	G	G	G			
Oxalic acid, 10% aq	C	E	C	C	-	E	G	G	E	E	C	C	U	C	C	U	C	C	C	C	C	C	C	C	C	C	C			
Oxygen ¹	U	U	U	U	-	E	-	-	-	-	-	-	G	G	G	G	G	G	G	G	G	G	G	G	G	G	G			
Palmitic acid	E	E	E	E	-	G	E	G	G	E	-	E	G	-	E	G	-	E	G	-	E	G	-	E	G	G	G			
Para-dichlorobenzene	U	E	-	U	-	U	U	U	U	E	-	-	G	G	G	G	G	G	G	G	G	G	G	G	G	G	G			
Pentane ¹	Lpg approved hose only						E	E	U	E	U	G	G	G	G	G	G	G	G	G	G	G	E	G	E	G	E	G		
Perchloric acid	U	E	U	U	-	G	E	G	G	E	U	U	U	U	U	U	U	U	U	U	U	U	U	U	U	U	U			
Perchloroethylene	U	E	U	U	-	U	U	U	U	E	U	U	C	G	G	G	E	U	C	G	G	G	G	E	E	E	E			
Petroleum base oils	G	E	E	E	-	U	E	G	U	E	E	E	E	E	E	E	E	E	E	E	E	E	E	E	E	E	E			
Phenol (carbolic acid)	U	E	U	U	-	U	U	U	G	E	U	U	U	U	U	U	U	U	U	U	U	E	E	E	E	G	E			
Phosphate ester ²	U	E	C	U	-	E	U	U	G	C	U	G	E	E	U	U	E	E	E	E	E	E	E	E	E	E	E			
Phosphoric acid 20%	U	E	U	U	-	E	U	U	G	E	U	U	U	U	U	U	U	U	U	U	U	U	U	C	E	E	E			
Phosphorous trichloride	U	E	U	U	-	E	U	U	E	E	U	U	C	U	C	U	C	E	E	E	E	E	E	E	E	E	E			
Potassium Acetate, 10% aq	G	E	-	G	-	E	G	G	E	U	-	-	C	G	C	U	G	C	U	G	C	U	G	C	U	G	C			
Potassium chloride, 10% aq	E	E	E	E	-	E	E	E	E	E	E	E	E	E	E	E	E	E	E	E	E	C	E	U	G	U	G			
Potassium cyanide, 10% aq	E	E	E	G	-	E	E	E	E	E	E	E	E	E	E	E	E	E	E	E	C	U	G	U	C	C	C			
Potassium dichromate, 10% aq	E	E	E	E	-	E	E	E	E	E	E	E	E	E	E	E	E	E	E	E	C	C	C	C	C	C	C			
Potassium hydroxide, to 10%	G	E	C	C	-	E	G	G	E	G	C	C	G	G	G	G	G	G	G	G	G	G	G	U	E	E	E			
Potassium hydroxide, over 10%	C	E	U	C	-	E	C	C	E	U	U	U	U	U	U	U	U	U	U	U	U	U	G	G	G	U	E			
Potassium nitrate, 10% aq	E	E	E	E	-	E	E	E	E	E	E	E	E	E	E	E	E	E	E	E	G	G	E	G	-	-	-			
Potassium sulfate, 10% aq	E	E	E	E	-	E	E	E	E	E	E	E	E	E	E	E	E	E	E	E	-	-	-	-	-	-	-			
Propane ¹ (liquefied)	LPG approved hose only						C	-	-	-	-	-	E	E	E	E	E	E	E	E	E	E	E	E	E	E	E	E		

Hose selection

Fluid compatibility

This chart is intended for reference use only. The information in this chart pertains strictly to material compatibility and is not intended to be used as an application guide. For information on specific applications not included in this catalog, please contact Eaton Weatherhead.

*Viton is a trademark of The Chemours Company FC, LLC.
 †Hytrell is a registered trademark of E.I. du Pont.
 ‡Monel is a registered trademark of Special Metals Corporation group of Companies.
 Note 1 - Rubber-covered hose must be perforated to allow gas to escape.
 Note 2 - Due to the widely different additives in these fluids, testing should be done on the actual fluid being considered.

Fluid	Synthetic rubber						Thermoplastic elastomer						Special application hose						Seals						Metal					
	PTFE		CPE		EPDM		Buna-N		Neoprene		EPR		Viton*		Urethane		Hytrell†		Steel		Brass		Stainless steel		Aluminum		Monel‡			
	1	2	3	4	5	6	1	2	3	4	5	6	1	2	3	4	5	6	1	2	3	4	5	6	1	2	3	4	5	6
Propyl acetate	U	E	-	U	-	G	U	U	U	U	U	U	U	U	U	U	U	U	U	U	U	U	U	U	U	U	U	U	U	U
Propyl alcohol	E	E	U	E	-	E	E	E	E	E	E	E	E	E	E	E	E	E	E	E	E	E	E	E	E	E	E	E	E	E
Propylene ¹	U	E	-	U	-	U	U	U	U	U	U	U	U	U	U	U	U	U	U	U	U	U	U	U	U	U	U	U	U	U
Refrigerant R-121	E	-	G	C	-	C	G	E	C	E	E	E	E	E	E	E	E	E	E	E	E	E	E	E	E	E	E	E	E	E
Refrigerant R-131	E	-	G	C	-	G	G	E	C	E	E	E	E	E	E	E	E	E	E	E	E	E	E	E	E	E	E	E	E	E
Refrigerant R-221	U	C	U	U	-	E	U	E	C	U	U	U	U	U	U	U	U	U	U	U	U	U	U	U	U	U	U	U	U	U
Refrigerant R-134a1	C	C	U	U	-	E	E	C	U	U	U	U	U	U	U	U	U	U	U	U	U	U	U	U	U	U	U	U	U	U
Sewage	G	E	E	G	-	E	E	E	E	E	E	U	E	G	G	G	G	G	G	G	G	G	G	G	G	G	G	G	G	G
Silicone oils	G	E	E	G	-	E	E	E	E	E	E	E	E	E	E	E	E	E	E	E	E	E	E	E	E	E	E	E	E	E
Soap (water solutions)	E	E	C	E	-	E	E	E	E	E	E	C	C	E	E	E	U	E	E	E	E	E	E	E	E	E	E	E	E	E
Sodium acetate, 10% aq	G	U	-	G	-	E	G	G	E	U	-	-	E	E	G	E	E	E	E	E	E	E	E	E	E	E	E	E	E	E
Sodium Bicarbonate, 10% aq	E	E	E	E	-	E	E	E	E	E	E	E	E	G	G	E	G	E	G	E	G	E	G	E	G	E	G	E	G	E
Sodium borate, 10% aq	E	E	E	E	-	E	E	E	E	E	E	E	E	E	E	E	E	E	E	E	E	E	E	E	E	E	E	E	E	E
Sodium carbonate, 10% aq	E	E	E	E	-	E	E	E	E	E	E	E	E	G	E	U	E	E	E	E	E	E	E	E	E	E	E	E	E	
Sodium chloride, 10% aq	E	E	E	G	-	E	E	E	E	E	E	E	U	C	C	C	C	E	C	C	C	C	C	C	C	C	C	C	C	C
Sodium cyanide, 10% aq	E	E	E	E	-	E	E	E	E	E	E	E	E	-	C	U	U	U	U	U	U	U	U	U	U	U	U	U	U	U
Sodium hydroxide, to 10%	C	E	G	C	-	E	U	G	E	E	G	G	C	G	C	U	C	C	C	C	C	C	C	C	C	C	C	C	C	C
Sodium hydroxide, over 10%	U	E	C	U	-	E	U	U	G	E	C	C	C	C	C	U	U	U	U	U	U	U	U	U	U	U	U	U	U	U
Sodium hypochlorite, 10% aq	C	E	C	G	-	G	C	E	C	C	C	U	U	U	U	U	U	U	U	U	U	U	U	U	U	U	U	U	U	U
Sodium metaphosphate, 10% aq	E	E	E	E	-	E	E	E	E	E	E	E	E	G	G	U	G	G	U	G	U	G	U	G	U	G	U	G	U	G

Resistance key rating

- E** = Excellent – Fluid has little or no effect.
- G** = Good – Fluid has minor to moderate effect.
- C** = Conditional – Service conditions should be described to Eaton Weatherhead for determination of suitability for application.
- U** = Unsatisfactory

Fluid	Synthetic rubber						Thermoplastic elastomer						Special application hose						Seals						Metal							
	PTFE		CPE		EPDM		Buna-N		Neoprene		EPR		Viton*		Urethane		Hytrell†		Steel		Brass		Stainless steel		Aluminum		Monel‡					
	1	2	3	4	5	6	1	2	3	4	5	6	1	2	3	4	5	6	1	2	3	4	5	6	1	2	3	4	5	6		
Sodium nitrate, 10% aq	G	E	E	G	-	E	G	G	E	-	E	E	G	G	E	-	E	E	E	E	E	E	E	E	E	C	E	E	E	E		
Sodium perborate, 10% aq	G	E	-	G	-	E	G	G	E	E	-	-	C	U	C	U	C	U	C	U	C	U	C	U	C	U	C	U	C			
Sodium peroxide, 10% aq	G	E	-	G	-	G	G	G	E	E	U	-	U	U	C	C	U	U	C	C	U	U	C	C	U	U	C	C	U	U	C	C
Sodium phosphates, 10% aq	E	E	E	C	-	E	E	E	E	E	E	E	E	E	E	E	E	E	E	E	E	E	E	U	E	G	U	E	E			
Sodium silicate, 10% aq	E	E	E	G	-	E	E	E	E	E	E	E	E	E	E	E	E	E	E	E	E	E	E	E	E	E	E	E	E			
Sodium sulfate, 10% aq	E	E	E	G	-	E	E	E	E	E	E	E	E	C	G	G	G	G	G	G	G	G	G	G	G	G	G	G	G	G		
Sodium sulfide, 10% aq	E	E	E	G	-	E	E	E	E	E	E	E	E	C	U	C	U	G	U	C	U	G	U	C	U	C	U	G	U	G		
Sodium thiosulfate, 10% aq	G	E	E	G	-	E	G	E	E	E	E	E	U	U	C	G	E	U	U	C	G	E	U	U	C	G	E	U	U	C	G	E
Soy bean oil	E	E	G	C	-	U	E	G	U	E	G	G	E	E	E	E	E	E	E	E	E	E	E	E	E	E	E	E	E	E		
Stannic chloride	G	E	C	G	-	E	E	G	E	E	C	C	U	U	U	U	U	U	U	U	U	U	U	U	U	U	U	U	U			
Steam ¹ (up to 388°F)	U	E	U	U	-	G	U	U	C	C	U	U	E	E	E	E	E	E	E	E	E	E	E	E	E	E	E	E	E	E		
Stearic acid	G	E	G	G	-	G	G	G	G	E	G	G	C	C	E	C	E	C	C	E	C	E	C	E	E	E	E	E	E	E		
Stoddard solvent	G	E	U	C	-	U	E	G	U	E	U	U	E	E	E	E	E	E	E	E	E	E	E	E	E	E	E	E	E	E		
Styrene	U	E	U	U	-	U	U	U	U	G	U	U	E	E	E	E	E	E	E	E	E	E	E	E	E	E	E	E	E	E		
Sulfur, slurry	C	E	G	E	-	E	U	E	E	E	G	G	E	U	G	E	U	E	E	E	E	E	E	U	G	E	U	G	E	U		
Sulfur chloride, wet	U	E	-	U	-	U	U	U	U	E	-	-	G	-	G	U	G	U	G	U	G	U	G	U	G	U	G	U	G			
Sulfur dioxide, dry ¹	U	E	U	U	-	E	U	U	G	E	U	U	E	G	E	U	E	E	E	E	E	E	G	E	G	E	G	E	G			
Sulfuric acid, to 10%	U	E	U	U	-	E	U	G	U	E	C	C	U	G	C	U	G	C	U	G	C	U	G	C	U	G	C	U	G			
Sulfuric acid, over 10%	U	E	U	U	-	U	U	U	U	G	U	U	U	C	C	U	C	U	C	U	C	U	C	U	C	U	C	U	C			
Sulfurous acid	U	E	U	G	-	G	C	C	U	G	U	U	U	C	C	U	U	U	U	U	U	U	C	C	U	C	C	U	C			
Tannic acid	G	E	G	G	-	E	G	E	E	E	E	G	G	E	E	E	E	G	G	E	E	E	E	E	E	E	E	E	E	E		
Tar (Bituminous)	G	E	G	G	-	U	G	U	U	E	G	G	E	G	E	G	E	G	G	E	G	E	G	E	E	E	E	E	E	E		
Tartaric acid	E	E	G	E	-	G	E	G	G	E	G	G	U	C	C	E	E	G	U	C	C	E	E	E	E	E	E	E	E	E		
Tertiary butyl alcohol	G	E	G	E	-	G	G	G	G	E	G	G	G	G	G	G	G	G	G	G	G	G	G	G	G	G	G	G	G	G		
Titanium tetrachloride	U	E	-	U	-	U	C	U	U	E	-	-	E	U	G	U	E	U	E	E	E	U	G	U	E	E	E	E	E			
Toluene (toluol)	U	E	U	U	-	U	U	U	U	E	U	U	U	E	U	U	E	U	E	E	E	E	E	E	E	E	E	E	E			

Hose selection

Fluid compatibility

A

Fluid	Hose						Seals						Metal					
	Synthetic rubber		Thermoplastic elastomer		Special application hose		Buna-N	Neoprene	EPR	Viton*	Urethane	Hytrell†	Steel	Brass	Stainless steel	Aluminum	Monel‡	
	1	2	3	4	5	6												
Trichlorethylene	U	E	U	U	-	U	U	U	U	E	U	U	E	G	E	E	E	
Tricresyl Phosphate	U	E	U	U	-	E	U	U	E	G	U	U	E	-	C	-	G	
Triethanolamine	G	E	U	G	-	E	E	U	E	U	U	U	E	U	E	E	E	
Tung Oil	E	E	C	C	-	U	G	G	U	E	U	C	E	G	E	E	E	
Turpentine	E	E	G	G	-	U	G	U	U	E	G	G	G	G	G	G	G	
Varnish	C	E	G	G	-	U	G	U	U	E	G	G	E	G	E	E	E	
Vinyl Chloride	U	E	U	U	-	U	U	U	U	E	U	U	E	U	C	E	E	
Water (to +150°F)	E	E	E	G	-	E	E	E	E	E	E	E	C	G	E	G	E	
Water (+151°F to +200°F)	C	E	U	C	-	E	E	E	E	E	U	U	C	G	E	G	E	
Water (+201°F to +350°F)	U	E	U	U	-	E	U	U	G	G	U	U	C	G	E	G	E	
Water Glycol	E	E	C	E	-	E	E	E	E	E	C	C	E	E	E	G	E	
Water Petroleum Emulsion²	E	E	C	C	-	U	E	G	U	E	C	C	C	E	E	G	E	
Xylene	U	E	C	U	-	U	U	U	U	E	U	C	E	E	E	E	E	
Zinc Chloride, 10% aq	E	E	E	E	-	E	E	E	E	E	E	E	U	U	C	G	G	
Zinc Sulfate, 10% aq	E	E	-	E	-	E	E	E	E	E	-	-	U	C	G	C	G	

Resistance key rating

- E** = Excellent – Fluid has little or no effect.
- G** = Good – Fluid has minor to moderate effect.
- C** = Conditional – Service conditions should be described to Eaton Weatherhead for determination of suitability for application.
- U** = Unsatisfactory

This chart is intended for reference use only.

The information in this chart pertains strictly to material compatibility and is not intended to be used as an application guide. For information on specific applications not included in this catalog, please contact Eaton Weatherhead

*Viton is a trademark of The Chemours Company FC, LLC.

†Hytrell is a registered trademark of E.I. du Pont.

‡Monel is a registered trademark of Special Metals Corporation group of Companies.

Note 1 - Rubber-covered hose must be perforated to allow gas to escape.

Note 2 - Due to the widely different additives in these fluids, testing should be done on the actual fluid being considered.

Hydraulic fluids & lubricating oils

The following charts are a representative list of fluids and manufacturers. The fluids are grouped under generic "family" heads and arranged alphabetically. For each generic "family" listing we have included maximum fluid temperature recommendations for the six hose classifications on page A-15 (1 through 6). Two maximum fluid temperature ratings are listed under designations of "H" and "LP". The "H" designation is for hydraulic service up to the maximum rated operating pressure of any particular hose in the classification. The "LP" designation is for low-pressure service such as lubricating oil systems or low-pressure hydraulic return lines. The letter "U" in the box indicates unsatisfactory resistance to the fluid type. Fluid temperature ratings are predicated on maximum allowable ambient temperatures as follows:

Classifications 1 and 3

(Synthetic rubber and thermoplastic elastomer)

"H" fluid temp. ratings: +140°F ambient

"LP" fluid temp. ratings: +180°F ambient

Classification 2 (PTFE)

"H" fluid temp. ratings: +400°F ambient

"LP" fluid temp. ratings: +400°F ambient

Classification 4 (CPE)

"H" fluid temp. ratings: +160°F ambient

"LP" fluid temp. ratings: +250°F ambient

(If "H" fluid temperature is +225°F or less, allowable ambient temperature may be increased to +200°F)

Ambient temperatures in excess of those recommended, in conjunction with maximum fluid temperatures, can materially shorten the service life of the hose.

Caution: The fluid manufacturer's recommended maximum operating temperature for any specific name brand fluid should be scrupulously observed by the user. These recommended temperatures can vary widely between name brands of different fluid compositions, even though they fall into the same generic "family" of fluids. Exceeding the manufacturer's recommended maximum temperature can result in fluid breakdown, producing by-products that are harmful to elastomeric products, as well as other materials in the system. If a manufacturer's recommended maximum temperature for his specific fluid is lower than that for the hose rating, it should take precedence over the hose rating for service usage.

Hydraulic fluids & lubricating oils (continued)

Straight petroleum-base

Maximum fluid temperature recommendation.

See caution on page A-32 for maximum fluid temperatures and limiting ambient temperatures.

Hose classifications (see page. A-32)

	1	2	3	4
H	+200°F	+400°F	+200°F	+300°F
LP	+200°F	+450°F	+200°F	+300°F

Fluid name

Aircraft hydraulic oil AA	DTE oils	OC turbine oils	Union ATF Dexron
Ambrex oils	Duro		Union ATF type F
Arco A.T.F. Dexron	Duro AW	Peaco oils	Union C-2 fluid
Arco A.T.F. dDexron IV		Pennbell oils	Union C-P oil
Arco A.T.F. Yype F	EP hydraulic oils	Power-tran fluid	Union custom motor oil
Arco fleet motor	EP industrial oils		Union gas engine oil
Arco H.T.F. C-2 fluid	EP machine oils	Quadroil series	Union Guardol motor oil
Arco H.T.C. 100 fluid	Energol HL68		Union heavy duty motor oil
Arco 303 fluid	Energol HLP C68	Rando oils	Union hydraulic oil AW
ATF special	Etna oils	Rando oils HD	Union hydraulic tractor fluid
Automatic transmission fluid (Dexron)	Exxon ATF	Redind oils	Union premium motor oil
		Regal oils R & O	Union S-1 motor oil
	Factovis 52 – Conventional R & O hydraulic fluid	Rimula oils	Union special motor oil
Carnea oils		Rotella oils	Union super motor oil
Citgo amplex		Rotella T oils	Union torque correction fluid
Citgo ATF, type F	Gulf harmony AW	RPM Delo 200 motor oils	Union turbine oil
Citgo ATF, Dexron	Gulf security AW	RPM Delo 300 motor oils	Union turbine Oil XD
Citgo extra duty circulating oils mineral oil (Heavy duty) (R & O)	Glide	RPM Delo special motor oils	Union Unax
Citgo motor oils	Hulburt 27 series	Rubilene	Union Unax AW
Citgo pacemaker series mineral oil (R & O)	Hydraulic series	Shell brand	Union Unax R & O
Citgo pacemaker t series mineral oil (R & O)	Hydraulic oils	Special motor oils	Union Unax RX
Citgo pacemaker XD series mineral oil (Heavy duty) (R & O)	Hydroil series	Sun R & O oils	Union Unitec motor oil
Citgo sentry	Industron 53 – anti wear hydraulic fluid	Suntac HP oils	Univis J13
Citgo tractor hydraulic fluid		Suntac WR oils	Univis J26
Conoco 303 fluid	Lubrite motor 20W-40	Sunvis 700 oils	Univis P32
Custom motor oil		Sunvis 800 oils	
		Sunvis 900 oils	Vactra oils
		Super hydraulic oils	Vitrea oils
		Supreme motor oils	
			Way lubricants
Dectol R & O oils	Mobil AFT 210		
Delo 400 motor oils	Mobil AFT 220		
Delvac oils	Mobilfluid 62	Tellus oils	XD-3 motor oils
Delvac SHC	Mobilfluid 423	Teresstic oils	
Delvac special 10W-30	Mobil hydraulic oils	Torque fluids	
Donax T oils	Mobiloil special	Torque fluid 47	
	Mobiloil super 10W-40	Torque fluid 56	
		Tractor hydraulic fluid	
	NUTO oils		

Hose selection

Fluid compatibility

A

Hydraulic fluids & lubricating oils (continued)

Water and petroleum oil emulsion (fr)

Maximum fluid temperature recommendation.

See caution on page A-32 for maximum fluid temperatures and limiting ambient temperatures.

Hose classifications (see page. A-32)

	1	2	3	4
H	+200°F	+250°F	+150°F	+200°F
LP	+200°F	+250°F	+150°F	+200°F

Fluid name

Aqualube	Masol fire resistant fluid
Astrol #587	Meltran FR 900
	Mine guard
Chevron FR Fluid D	Mobilmet S122
Chrysler L-705	
Citgo pacemaker invert FR fluid	Penn drake hydraqua fluid
Conoco FR hydraulic fluid	Permamul FR
	Puro FR fluid
	Pyrogard C
Dasco IFR	Pyrogard D
Duro FR-HD	
	Quintolubric 957 series
Fire resistant hydrafluid	Quintolubric 958 series
Fire resistant hydraulic Fluid B	
FR 3110 hydraulic fluid (invert)	Regent hydrolube #670
Fyre-safe W/O	
	Safoil hydraulic fluid anti-wear
Gulf R & D FR fluid	Sinclair Duro FR-HD
	Solvac 1535G
Houghto-safe 5046	Staysol FR
Houghto-safe 5046W	Sunsafe F
Hulsafe 500	
Hy-chock oil	Union FR fluid
Hydrasol A	Union soluble oil HD
Ironsides #814-A	Veedol auburn FRH
Irus fluid 905	Veedol auburn FRH Concentrate
Kutwell 40	

Water and glycol solution

Maximum fluid temperature recommendation.

See caution on page A-32 for maximum fluid temperatures and limiting ambient temperatures.

Hose classifications (see page. A-32)

	1	2	3	4
H	+200°F	+250°F	+150°F	C
LP	+200°F	+250°F	+150°F	C

Fluid name

Chem-trend HF-18	Maxmul
Chem-trend HF-20	Maxmul FR
Chevron glycol FR fluids	Melsyn 200
Citgo glycol FR fluids	Melsyn glycol FR
Citgo glycol FR-20 XD	
Citgo pacemaker	Nyvac FR fluid
	Nyvac FR 200 fluid
	Nyvac 20 (WG)
Dasco FR 150	Nyvac 30 (WG)
Dasco FR 200	
Dasco FR 200 B	
Dasco FR 310	Park water glycol hydraulic fluid
	Pennzoil fluid FR 2X
Fyrguard 150	
Fyrguard 200	
Fyre-Safe 225	Quintolubric 700 series
Gulf FR fluid G-200	Santosafe W/G 15
Gulf FR fluid – G series	Santosafe W/G 20
	Santosafe W/G 30
	Standard glycol FR #15
Houghto-safe 271	Standard glycol FR #20
Houghto-safe 416	Standard glycol FR #25
Houghto-safe 520	
Houghto-safe 525	
Houghto-safe 616	Ucon hydrolube 150 CP
Houghto-safe 620	Ucon hydrolube 200 CP
Houghto-Safe 625	Ucon hydrolube 275 CP
Houghto-safe 640	Ucon hydrolube 300 CP
Hydra safe 620	Ucon hydrolube 550 CP
Hydra safe 625	Ucon hydrolube 900 CP
Hydraulic safety fluid 200	Ucon hydrolube 150 DB
Hydraulic safety fluid 300	Ucon hydrolube 275 DB
Hyspin AF-1	Ucon hydrolube 150 LT
Hyspin AF-2	Ucon hydrolube 200 LT
Hyspin AF-3	Ucon hydrolube 275 LT
	Ucon hydrolube 300 LT
	Ucon M-1
	Ucon hydrolube 200 NM
	Ucon hydrolube 300 NM

Hydraulic fluids & lubricating oils (continued)

Straight phosphate-ester (fr)

Maximum fluid temperature recommendation.

See caution on page A-32 for maximum fluid temperatures and limiting ambient temperatures.

Hose classifications (see page. A-32)

	1	2	3	4	6
H	U	+400°F	+200°F	U	200
LP	U	+400°F	+200°F	U	200

Fluid name

FR Fluids Houghto-Safe 1010

Fyrquel 90 Houghto-Safe 1055

Fyrquel 150 Houghto-Safe 1115

Fyrquel 220 Houghto-Safe 1120

Fyrquel 300 Houghto-Safe 1130

Fyrquel 550

Fyrquel 1000 Pyrogard 51

Fyrquel 150 R & O Pyrogard 53

Fyrquel 220 R & O Pyrogard 55

Fyrquel 550 R & O

Safetytex 215

Gulf FR Fluid P-37 Skydraul 500A

Gulf FR Fluid P-40 Skydraul 7000

Gulf FR Fluid P-43

Gulf FR Fluid P-45 Univis P12

Gulf FR Fluid P-47

Silicone oils

Maximum fluid temperature recommendation.

See caution on page A-32 for maximum fluid temperatures and limiting ambient temperatures.

Hose classifications (see page. A-32)

	1	2	3	4
H	+200°F	+400°F	+200°F	+300°F
LP	+250°F	+400°F	+200°F	+300°F

Fluid name

Dow Corning 200 Dow Corning 4-3600

Fluid (100CS) Dow Corning 3-3672

Dow Corning QF1-2023

Ester blend turbine oils

Maximum fluid temperature recommendation.

See caution on page A-32 for maximum fluid temperatures and limiting ambient temperatures.

Hose classifications (see page. A-32)

	1	2	3	4
H	-	-	-	-
LP	+250°F	+450°F	+200°F	+300°F

Fluid name

Stauffer Jet I

Stauffer Jet II

Polyol-ester

Maximum fluid temperature recommendation.

See caution on page A-32 for maximum fluid temperatures and limiting ambient temperatures.

Hose classifications (see page. A-32)

	1	2	3	4
H	+150°F	+400°F	-	+150°F
LP	+200°F	+400°F	-	+250°F

Fluid name

Quintolubric 822 Series

Lubricant compatibility chart

Lubricant	Hose style		
	GH001	FC800	FC802
Mineral oil	Y	*	Y
PAG	Y	Y	Y
Ester oil	Y	Y	Y
Alkylbenzene	*	*	Y

Y = Compatible N = Non-compatible.

* Contact product support for application review.

Hose selection

Hose routing and installation

A

Hose routing and installation

1. Provide for length change.

In straight hose installations, allow enough slack in the hose line to provide for changes in length that will occur when pressure is applied. This change in length can be from +2% to -4%.

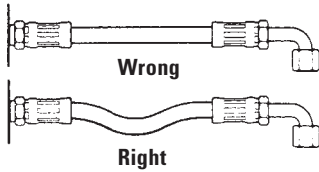

2. Avoid twisting and orient properly.

Do not twist hose during installation. This can be determined by the printed layline on the hose. Pressure applied to a twisted hose can cause hose failure or loosening of connections.

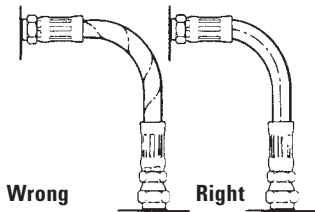

3. Protect from hazardous environment.

Keep hose away from hot parts. High ambient temperature will shorten hose life. If you can not route it away from the heat source, insulate it. (See Spring Guards page K-2)

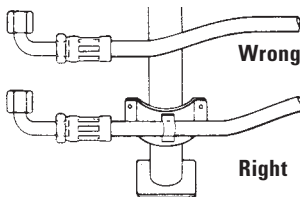

4. Avoid mechanical strain.

Use elbows and adapters in the installation to relieve strain on the assembly and to provide easier and neater installations that are accessible for inspection and maintenance.

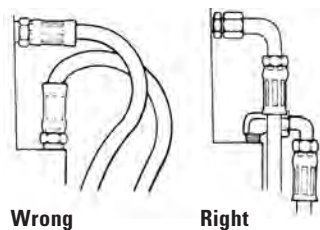

5. Use proper bend radius.

Keep the bend radius of the hose as large as possible to avoid collapsing of the hose and restriction of flow. Follow catalog specs on minimum bend radii.

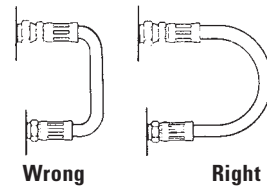

6. Use proper bend radius (cont'd).

Minimum bend radius is measured on the inside bend of the hose. To determine minimum bend, divide the total distance between ends (B length) by 2. For example, B=6, minimum bend radius=3.

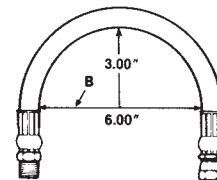

7. Secure for protection.

Install hose runs to avoid rubbing or abrasion. Use Weatherhead Hose Clamps to support long runs of hose or to keep hose away from moving parts. It is important that the clamps not allow the hose to move. This movement will cause abrasion and premature hose failure. See Hose Clamps page K-6.

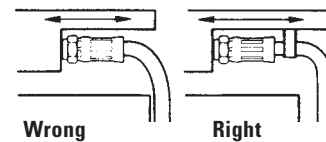

8. Avoid improper hose movement.

Make sure relative motion of the machine components produces bending rather than twisting of the hose. Hose should be routed so that the flex is in the same plane as the equipment movement.

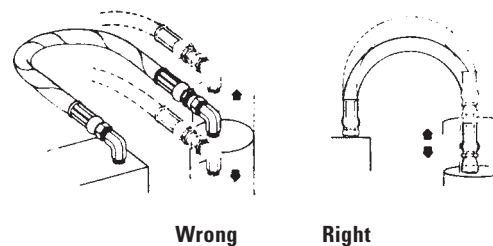

 Refer to safety information regarding hose installation on pages A-2.

Analyzing failures

Everyone in maintenance encounters hose failures. Normally, there is no problem. The hose is replaced and the equipment goes back in operation. Occasionally the failures come too frequently – the same equipment with the same problems keep popping up. At this point the task is to determine and correct the cause of these repeated failures.

Improper application

Beginning with the most obvious, the most common cause of hose failures – Improper application – compare the hose specifications with the requirements of the application.

Pay particular attention to the following areas:

- The maximum operating pressure of the hose.
- The recommended temperature range of the hose.
- Whether the hose is rated for vacuum service.
- The fluid compatibility of the hose.

Check all of these areas against the requirements of the application. If they don't match up, you need to select another hose. It's a good idea at this point to call on your local hose distributor for assistance in selecting the proper hose. Eaton's distributors, for example, are well equipped to perform this service for you.

Distributor personnel attend special training courses in hydraulics and hose application conducted by the company. Or, if your problem is particularly difficult, the distributor can call on the services of Eaton's field engineering staff. The company will send in a hose and hydraulic specialist to study the problem and come up with a solution.

Improper assembly and installation

The second major cause of premature hose failure is improper assembly and installation procedures. This can involve anything from using the wrong fitting on a hose, to poor routing of the hose.

Eaton provides excellent training material that you can use to combat this problem. A little time spent in training your maintenance people could pay big dividends in reduced downtime.

Contact Eaton to register for a training session today.

External damage

External damage can range from abrasion and corrosion, to hose that is crushed by a lift truck. These are problems that can normally be solved simply once the cause is identified. The hose can be re-routed or clamped, or a fire sleeve or abrasion guard can be used.

In the case of corrosion, the answer may be as simple as changing to a hose with a more corrosion resistant cover or re-routing the hose to avoid the corrosive element.

Faulty equipment

Too frequent or premature hose failure can be the symptom of a malfunction in your equipment. This is a factor that should be considered since prompt corrective action can sometimes avoid serious and costly equipment breakdown. Reprints of an article on "Troubleshooting hydraulic systems," which tells you how to spot problems in a hydraulic system are available from Eaton.

Faulty hose

Occasionally a failure problem will lie in the hose itself. The most likely cause of a faulty rubber hose is old age. Check the lay line on the hose to determine the date of manufacture. (2Q99 means second quarter 1999.) The hose may have exceeded its recommended shelf life. If you suspect that the problem lies in the manufacture of the hose (and don't jump to this conclusion until you have exhausted the other possibilities) contact your distributor. Given effective quality control methods, the odds of a faulty batch of hose being released for sale are extremely small. So make sure that you haven't overlooked some other problem area.

Analyzing failures

A physical examination of the failed hose can often offer a clue to the cause of the failure. Following are 22 symptoms to look for along with the conditions that could cause them:

1. Symptom: The hose tube is very hard and has cracked.



Cause: Heat has a tendency to leach the plasticizers out of the tube. This is a material that gives the hose its flexibility or plasticity.

Aerated oil causes oxidation to occur in the tube. This reaction of oxygen on a rubber product will cause it to harden. Any combination of oxygen and heat will greatly accelerate the hardening of the hose tube. Cavitation occurring inside the tube would have the same effect.

2. Symptom: The hose is cracked both externally and internally but the elastomeric materials are soft and flexible at room temperature.



Cause: The probable reason is intense cold ambient conditions while the hose was flexed. Most standard hoses are rated to -40°F (-40°C). Some hoses are rated at -55°F (-49°C). Military specified hoses are generally rated to -65°F (-54°C). PTFE hose is rated to -100°F (-73°C). Some Everflex Polyon thermoplastic hoses are rated at -65°F (-54°C).

3. Symptom: The hose has burst and examination of the wire reinforcement after stripping back the cover reveals random broken wires the entire length of the hose.



Cause: This would indicate a high frequency pressure impulse condition. SAE impulse test requirements for a double wire braid reinforcement are 200,000 cycles at 133% of recommended working pressure. The SAE impulse test requirements for a four spiral wrapped reinforcement (100R12) are 500,000 cycles at 133% maximum operating and at +250°F (121°C). If the extrapolated impulses in a system amount to over a million in a relatively short time a spiral reinforced hose would be the better choice.

Hose selection

Analyzing failures

A

Analyzing failures

4. Symptom: The hose has burst, but there is no indication of multiple broken wires the entire length of the hose. The hose may have burst in more than one place.



Cause: This would indicate that the pressure has exceeded the minimum burst strength of the hose. Either a stronger hose is needed or the hydraulic circuit has a malfunction which is causing unusually high pressure conditions.

5. Symptom: Hose has burst. An examination indicates the wire braid is rusted and the cover has been cut, abraded or deteriorated badly.



Cause: The primary function of the cover is to protect the reinforcement. Elements that may destroy or remove the hose covers are:

1. Abrasion
2. Cutting
3. Battery acid
4. Steam cleaners
5. Chemical cleaning solutions
6. Muriatic acid (for cement clean-up)
7. Salt water
8. Heat
9. Extreme cold

Once the cover protection is gone the wire reinforcement is susceptible to attack from moisture or other corrosive matter.

6. Symptom: Hose has burst on the outside bend and appears to be elliptical in the bent section. In the case of a pump supply line, the pump is noisy and very hot. The exhaust line on the pump is hard and brittle.

Cause: Violation of the minimum bend radius is most likely the problem in both cases. Check the minimum bend radius and make sure that the application is within specifications. In the case of the pump supply line partial collapse of the hose is causing the pump to cavitate creating both noise and heat. This is a most serious situation and will result in catastrophic pump failure if not corrected.

7. Symptom: Hose appears to be flattened out in one or two areas and appears to be kinked. It has burst in this area and also appears to be twisted.



Cause: Torquing of a hydraulic control hose will tear loose the reinforcement layers and allow the hose to burst through the enlarged gaps between the braided plait of wire strands. Use swivel fittings or joints to be sure there is no twisting force on a hydraulic hose.

8. Symptom: Hose type has broken loose from the reinforcement and piled up the end of the hose. In some cases it may protrude from the end of the hose fitting.

Cause: The probable cause is high vacuum or the wrong hose for vacuum service. No vacuum is recommended for double wire braid, 4 and 6 spiral wire hose unless some sort of internal coil support is used. Even though a hose is rated for vacuum service, if it is kinked, flattened out or bent too sharply this type of failure may occur.

9. Symptom: Hose has burst about six to eight inches away from the end fitting. The wire braid is rusted. There are no cuts or abrasions of the outer cover.

Cause: Improper assembly of the hose end fitting allowing moisture to enter around the edge of the fitting socket. The moisture will wick through the reinforcement. The heat generated by the system will drive it out around the fitting area but six to eight inches away it will be entrapped between the inner line and outer cover causing corrosion of the wire reinforcement.

10. Symptom: There are blisters in the cover of the hose. If one pricks the blisters, oil will be found in them.

Cause: A minute pin hole in the hose tube is allowing the high pressure oil to seep between it and the cover. Eventually it will form a blister wherever the cover adhesion is weakest. In the case of a screw together reusable fitting insufficient lubrication of the hose and fitting can cause this condition because the dry tube will adhere to the rotating nipple and tear enough to allow seepage. Faulty hose can also cause this condition.

11. Symptom: Blistering of the hose cover where a gaseous fluid is being used.



Cause: The high pressure gas is effusing through the hose tube, gathering under the cover and eventually forming a blister wherever the adhesion is weakest. Specially constructed hoses are available for high pressure gaseous applications. Your supplier can advise you on the proper hose to use in these cases.

12. Symptom: Fitting blew off of the end of the hose.

Cause: It may be that the wrong fitting has been put on the hose. Recheck manufacturer's specifications and part numbers. In the case of a crimped fitting the wrong machine setting may have been used resulting in over or under crimping. The socket of a screw together fitting for multiple wire braided hose may be worn beyond its tolerance. The swaging dies in a swaged hose assembly may be worn beyond the manufacturer's tolerances. The fitting may have been applied improperly to the hose. Check manufacturer's instructions. The hose may have been installed without leaving enough slack to compensate for the possible 4% shortening that may occur when the hose is pressurized. This will impose a great force on the fitting. The hose itself may be out of tolerance.

13. Symptom: The tube of the hose is badly deteriorated with evidences of extreme swelling. In some cases the hose tube may be partially "washed out."



Cause: Indications are that the hose tube is not compatible with the agent being carried. Even though the agent is normally compatible, the addition of heat can be the catalyst that can cause inner liner deterioration. Consult your hose supplier for a compatibility list or present him with a sample of the fluid being conducted by the hose for analysis. Make sure that the operating temperatures

Analyzing failures

both internal and external do not exceed recommendations.

14. Symptom: Hose has burst. The hose cover is badly deteriorated and the surface of the rubber is crazed.

Cause: This could be simply old age. The crazed appearance is the effect of weathering and ozone over a period of time. Try to determine the age of the hose. Some manufacturers print or emboss the cure date on the outside of the hose. As an example, Weatherhead hose would show "4Q01" which would mean that the hose was manufactured during the fourth quarter (October, November or December) of 2001.

15. Symptom: Hose is leaking at the fitting because of a crack in the metal tube adjacent to the braze on a split flange head.

Cause: Because the crack is adjacent to the braze and not in the braze this is a stress failure brought on by a hose that is trying to shorten under pressure and has insufficient slack in it to do so. We have cured dozens of these problems by lengthening the hose assembly or changing the routing to relieve the forces on the fitting.

16. Symptom: A spiral reinforced hose has burst and literally split open with the wire exploded out and badly entangled.



Cause: The hose is too short to accommodate the change in length occurring while it is pressurized.

17. Symptom: Hose is badly flattened out in the burst area. The tube is very hard down stream of the burst but appears normal up stream of the burst.



Cause: The hose has been kinked either by bending it too sharply or by squashing it in some way so that a major restriction was created. As the velocity of the fluid increases through the restriction the pressure decreases to the vaporization point of the fluid being conveyed. This is commonly called cavitation, and causes heat and rapid oxidation to take place which hardens the tube of the hose down stream of the restriction.

18. Symptom: Hose has not burst but it is leaking profusely. A bisection of the hose reveals that the tube has been gouged through to the wire braid for a distance of approximately two inches.

Cause: This failure would indicate that erosion of the hose tube has taken place. A high velocity needle like fluid stream being emitted from an orifice and impinging at a single point on the hose tube will hydraulically remove a section of it. Be sure that the hose is not bent close to a port that is orificed. In some cases where high velocities are encountered particles in the fluid can cause considerable erosion in bent sections of the hose assembly.

19. Symptom: The hose fitting has been pulled out of the hose. The hose has been considerably stretched out in length. This may not be a high pressure application.

Cause: Insufficient support of the hose. It is very necessary to support very long lengths of hose, especially if they are vertical. The weight of the hose along with the weight of the fluid inside the hose in these cases is being imposed on the hose fitting. This force can be transmitted to a wire rope or chain by clamping the hose to it much like the utilities support bundles of wire from pole to pole. Be sure to leave sufficient slack in the hose between clamps to make up for the possible 4% shortening that could take place when the hose is pressurized.

20. Symptom: The hose has not burst but it is leaking profusely. An examination of the bisected hose reveals that the tube has burst inwardly.

Cause: This type of failure is commonly referred to as hose tube blow down. It is usually associated with very low viscosity fluids such as air, nitrogen, freon and other gases. What happens is that under high pressure conditions the gases will effuse into the pores of the hose tube charging them up like miniature accumulators. If the pressure is very suddenly reduced to zero the entrapped gases literally explode out of the tube often tearing holes in it. In some hose constructions a second hose tube made from a plastic such as nylon, is inserted into the hose.

A small leak will allow the gaseous fluid to seep between the two inner liners and when pressure is reduced to zero the innermost liner will collapse because the entrapped pressure around its inner diameter.

21. Symptom: PTFE hose assembly has collapsed internally in one or more places.

Cause: One of the most common causes for this is improper handling of the PTFE assembly. PTFE is a thermoplastic material which is not rubber-like. When bent sharply it simply collapses. This type of collapse is localized in one area and is radical. When the PTFE tube is folded longitudinally in one or more places this could be the result of heat (which softens the hose) along with vacuum conditions inside of it. Because of the additional tension of the wire braid, reinforcement inherent with this type of hose, there is always a radial tension on the tube trying to push it in. Rapid cycling from a very hot agent in the hose to a very cold agent in the hose can produce the same type of failure. Eaton Weatherhead offers an internal support coil that will eliminate this problem.

22. Symptom: A PTFE hose assembly has developed a pin hole leak or several pin hole leaks.

Cause: This situation occurs when a petroleum based fluid, with low viscosity, is flowing at high velocity. This condition can generate high voltage due to static electricity. The high voltage is seeking a ground connection and the only ground connection available is the braided stainless steel reinforcement. This causes an electric arc, which penetrates through the PTFE tube as it travels to the reinforcement. Specially constructed PTFE tubes are available that have enough carbon black in them so as to be conductive. They will "drain off" the static electricity and preclude this problem.

Fluid connectors

Fluid connectors identification

A

Fluid connectors identification

Measuring Tools: A seat angle gauge, thread pitch gauge and an I.D./O.D. caliper are necessary to make accurate measurements of commonly used connectors. Eaton offers a unique new caliper that offers the capabilities of both a caliper and a seat angle gauge in one unit.



FT1341

Identification Tool Kit

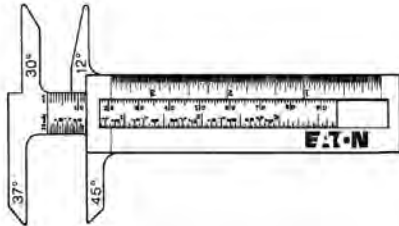

I.D./O.D. Angle gauge caliper

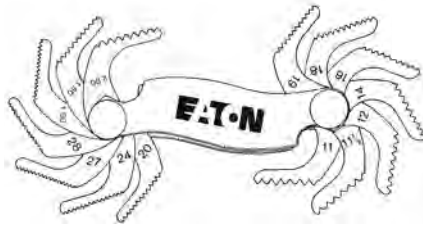

Thread pitch gauge

How to measure threads

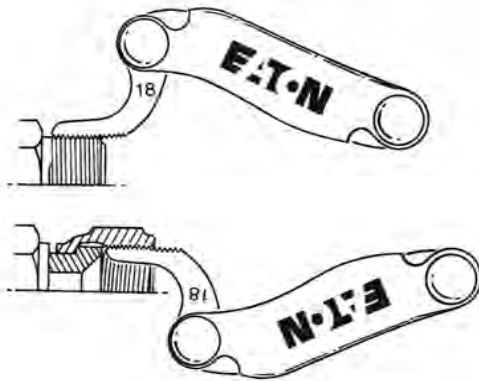

Use a thread pitch gauge to determine the number of threads per inch or the distance between threads in metric connections. Place the gauge on the threads until the fit is snug. Match the measurement to the charts.

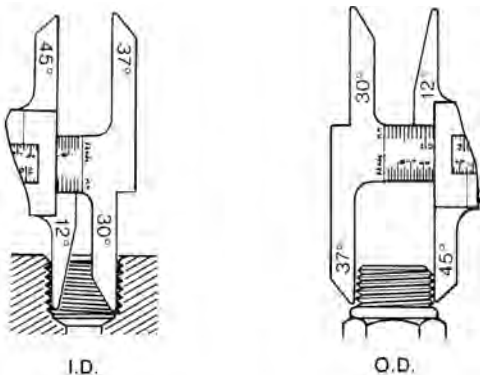

Measure the thread diameter with an I.D./O.D. caliper as shown. Match the measurements to the charts.

How to measure sealing surface angles

Female connections are usually measured by inserting the gauge into the connection and placing it on the sealing surface. If the centerlines of the connection and gauge are parallel, the correct angle has been determined.

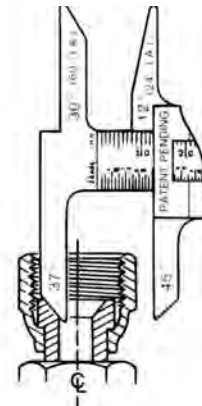

Male flare type connectors are usually measured by placing the gauge on the sealing surface. If the centerlines of the connection and gauge are parallel, the correct angle has been determined.

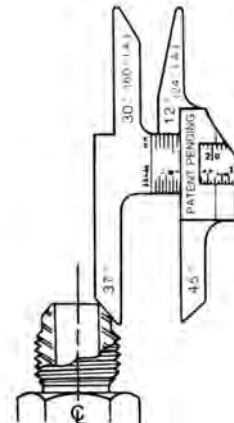

Thread size chart

The following chart is intended as a quick reference guide for thread size by dash size.

Dash size	N.P.T.F.		N.P.S.M. approx. dia.		SAE 45° auto. refriger.		SAE 37° (J.I.C.) hydraulic		SAE O-Ring boss		P.T.T. 30° automotive		SAE invert. flare		ORS	
	Thread O.D.	Thread I.D.	Thread O.D.	Thread I.D.	Thread O.D.	Thread I.D.	Thread O.D.	Thread I.D.	Thread O.D.	Thread I.D.	Thread O.D.	Thread I.D.	Thread O.D.	Thread I.D.	Thread O.D.	Thread I.D.
-02	1/8-27		1/8-27		5/16-24		5/16-24		5/16-24		-		5/16-24		-	
-03	-		-		3/8-24		3/8-24		3/8-24		-		3/8-24		-	
-04	1/4-18		1/4-18		7/16-20		7/16-20		7/16-20		-		7/16-24		9/16-18	
-05	-		-		1/2-20		1/2-20		1/2-20		-		1/2-20		-	
-06	3/8-18		3/8-18		5/8-18		9/16-18		9/16-18		-		5/8-18		11/16-16	
-07	-		-		11/16-24		-		-		-		11/16-18		-	
-08	1/2-14		1/2-14		3/4-16		3/4-16		3/4-16		-		3/4-18		13/16-16	
-10	-		-		7/8-14		7/8-14		7/8-14		-		7/8-18		1-14	
-12	3/4-14		3/4-14		1 1/16-14		1 1/16-12		1 1/16-12		-		1 1/16-16		1 3/16-12	
-14	-		-		-		1 3/16-12		1 3/16-12		-		-		-	
-16	1-11 1/2		1-11 1/2		-		1 5/16-12		1 5/16-12		1 5/16-14		-		1 7/16-12	
-20	1 1/4-11 1/2		1 1/4-11 1/2		-		1 5/8-12		1 5/8-12		1 5/8-14		-		1 11/16-12	
-24	1 1/2-11 1/2		1 1/2-11 1/2		-		1 7/8-12		1 7/8-12		1 7/8-14		-		2-12	
-32	2-11 1/2		2-11 1/2		-		2 1/2-12		2 1/2-12		2 1/2-12		-		-	
-40	2 1/2-8		2 1/2-8		-		3-12		3-12		-		-		-	
-48	3-8		3-8		-		3 1/2-12		3 1/2-12		-		-		-	

Through hole dimensions

All dimensions are nominal. In jump size bodies, the minimum through hole dimensions will correspond to the smallest dash size.

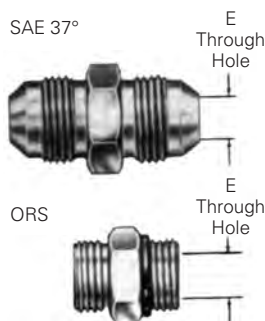

Dash size	E through hole			
	SAE 37°		ORS	
	mm	in	mm	in
-03	3,0	0.12	-	-
-04	4,3	0.17	4,3	0.17
-05	5,8	0.23	-	-
-06	7,6	0.30	6,6	0.26
-08	9,9	0.39	9,7	0.38
-10	12,2	0.48	12,2	0.48
-12	15,5	0.61	15,5	0.61
-16	21,3	0.84	20,6	0.81
-20	25,8	1.08	26,1	1.03
-24	33,3	1.31	32,0	1.26
-32	45,2	1.78	-	-

Fluid connectors

Proper tube installation

A

Proper tube installation

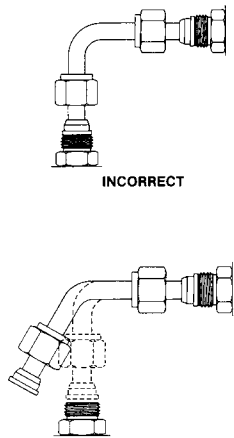

Figure 1

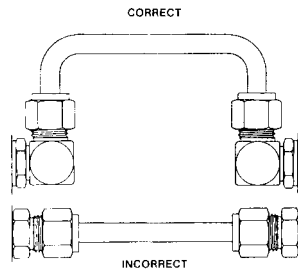

Figure 2

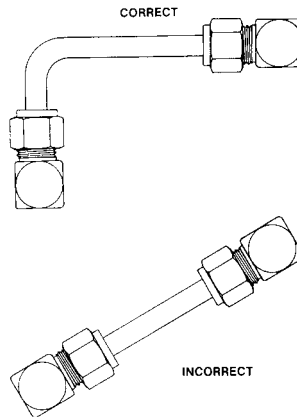

Figure 3

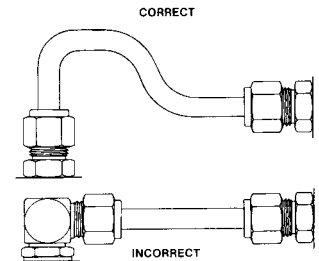

Figure 4

When compared to rigid pipe, hydraulic tubing offers the following advantages:

3. Size for size, tubing is lighter in weight, easier to handle and can be bent more easily than iron pipe.
4. Bent tubing reduces pressure drop and turbulence in the system because it eliminates sudden change in the direction of the fluid flow.
5. Hydraulic tubing reduces the number of connections required, thus reducing material and labor costs.
6. Fewer joints means lower costs and fewer points of potential leakage.
7. The use of tube fittings makes every joint a union which permits easier, faster maintenance and repair work.
8. The ORS-TF Tube Fitting eliminates the need for threading, brazing or welding.

Tube bending

To reduce the number of fittings in a tube assembly, bend the tubing whenever possible.

Steel tubing can be bent in many sizes by using a hand bender designed for steel tubing. For production quantities, or for larger sizes, a power bending tool is generally used.

Contact Eaton for additional tube bending information.

Tube routing and installation

Tubing manufacturers will advise the correct radii for various types and wall thicknesses of tubing. Kinks, flattened bends, wrinkles and tube breakage can be avoided by the use of proper tube bending equipment.

Avoid straight line connections whenever possible, especially in short runs.

Fluid conveying systems (see figures 2, 3 and 4) should be designed to follow the contour of the equipment. They are easier to install and present a neater appearance. Long runs should be supported by brackets or clamps. All heavy systems components should be bolted or clamped to eliminate tubing fatigue.

Inspect the tubing to see that it conforms to the required specifications before installation.

Tubes should align with the center line of the fittings, without distortion or tension. Tubing should not be sprung into position (see figure 1) to be assembled to the fitting. If this occurs the tubing has not been properly fabricated, and when installed and connected, places the tubing under stress.

Hydraulic tubing—Maximum operating pressures

SAEJ356, J524, J525, J526, J527

Tube O.D.	Dash size	Tubing wall thickness (in inches)											
		0.028		0.035		0.049		0.065		0.083		0.095	
		bar	psi	bar	psi	bar	psi	bar	psi	bar	psi	bar	psi
-	-												
0.19	-03	297,0	4250	375,0	5450	-	-	-	-	-	-	-	-
0.25	-04	213,0	3100	272,0	3950	396,0	5750	420,0	6000	-	-	-	-
0.31	-05	169,0	2450	213,0	3100	315,0	4500	420,0	6000	-	-	-	-
0.38	-06	140,0	2000	175,0	2550	251,0	3650	350,0	5000	420,0	6000	420,0	6000
0.50	-08	-	-	127,0	1850	186,0	2700	251,0	3650	335,0	4800	388,0	5550
0.62	-10	-	-	105,0	1500	145,0	2100	196,0	2850	258,0	3750	299,0	4350
0.75	-12	-	-	84,0	1200	122,0	1750	162,0	2350	210,0	3050	248,0	3550
1.00	-16	-	-	62,0	900	89,0	1300	122,0	1750	157,0	2250	182,0	2600
1.25	-20	-	-	-	-	70,0	1000	93,0	1350	122,0	1750	143,0	2050
1.50	-24	-	-	-	-	-	-	79,0	1150	100,0	1450	119,0	1700
2.00	-32	-	-	-	-	-	-	58,0	850	77,0	1100	87,0	1250

Tube O.D.	Dash size	Tubing wall thickness (in inches)											
		0.109		0.120		0.134		0.148		0.156		0.188	
		bar	psi	bar	psi	bar	psi	bar	psi	bar	psi	bar	psi
-	-												
0.19	-03	-	-	-	-	-	-	-	-	-	-	-	-
0.25	-04	-	-	-	-	-	-	-	-	-	-	-	-
0.31	-05	-	-	-	-	-	-	-	-	-	-	-	-
0.38	-06	-	-	-	-	-	-	-	-	-	-	-	-
0.50	-08	420,0	6000	420,0	6000	-	-	-	-	-	-	-	-
0.62	-10	353,0	5050	392,0	5600	-	-	-	-	-	-	-	-
0.75	-12	286,0	4150	322,0	4600	-	-	-	-	-	-	-	-
1.00	-16	210,0	3000	231,0	3350	262,0	3800	294,0	4200	-	-	-	-
1.25	-20	162,0	2350	182,0	2650	189,0	2700	203,0	2950	217,0	3100	259,0	3750
1.50	-24	134,0	1950	148,0	2150	171,0	2450	171,0	2450	182,0	2600	220,0	3150
2.00	-32	100,0	1450	112,0	1600	126,0	1800	140,0	2000	147,0	2100	178,0	2550

Maximum operating pressure ratings at specified wall thickness are based upon recommended tubing ratings per SAEJ1065 as well as

limited laboratory test data. Operating pressures are based upon a 4:1 safety factor relative to tube burst data. Eaton recommends a

maximum operating pressure of the joint which is the lesser of the tubing rating or the mating connector rating.

Fluid connectors

Recommendations: wall thickness and material

A

Recommended wall thickness for tube fitting applications

Tube	Dash	Versil-Flare 37° flared	Versil-Flare 37° flareless	ORS-BR ORB	ORS-TF
0.19	-03	0.028 - 0.035	0.028 - 0.035	-	-
0.25	-04	0.028 - 0.065	0.028 - 0.065	0.028 - 0.065	0.028 - 0.065
0.31	-05	0.028 - 0.065	0.028 - 0.065	-	-
0.38	-06	0.028 - 0.065	0.028 - 0.095	0.035 - 0.083	0.028 - 0.065
0.50	-08	0.035 - 0.083	0.035 - 0.120	0.035 - 0.109	0.035 - 0.120
0.62	-10	0.035 - 0.095	0.035 - 0.120	0.035 - 0.120	0.035 - 0.095
0.75	-12	0.035 - 0.109	0.035 - 0.120	0.035 - 0.120	0.049 - 0.120
1.00	-16	0.035 - 0.120	0.035 - 0.134	0.049 - 0.148	0.049 - 0.134
1.25	-20	0.049 - 0.120	0.049 - 0.188	0.049 - 0.188	0.049 - 0.156
1.50	-24	0.065 - 0.120	0.065 - 0.188	0.065 - 0.188	0.065 - 0.188
2.00	-32	0.065 - 0.134	0.065 - 0.188	-	-

Recommended hydraulic tubing material specifications

Hydraulic tubing SAE specifications

Versil-Flare 37° flared	Versil-Flare 37° flareless	ORS-BR ORS	ORS-TF ORS
SAEJ524	SAEJ356	SAEJ356	SAEJ356
SAEJ525	SAEJ524	SAEJ524	SAEJ524
-	SAEJ525	SAEJ525	SAEJ525
-	SAEJ527	SAEJ526	SAEJ526

Hydraulic tubing material description

SAEJ356 electric resistance welded flash controlled low carbon steel, SAEJ524 seamless annealed low carbon steel, SAEJ525 electric resistance welded

cold worked annealed, SAEJ526 single wall welded low carbon steel (automotive), SAEJ527 brazed double wall low carbon steel (automotive). The maximum hardness of the above tubing should not exceed Rockwell B65.

How to measure non-threaded connections

Four bolt flange

First measure the port hole diameter using the caliper. Next, measure the longest bolt hole spacing from center-to-center or measure the flange head diameter.

Staplok

Measure the male diameter with the O.D. portion of the caliper. Measure the female half by inserting the I.D. portion of the caliper into the through hole.

Dash numbers

Most fluid piping system sizes in the United States are measured by dash numbers. These are universally used abbreviations for the size of the component expressed as the numerator of the fraction

with the denominator always being 16. For example, a -04 port is 4/16 or 1/4-inch. Dash numbers are usually nominal (in name only) and are abbreviations that make ordering of components easier.

American connections

NPTF (National pipe tapered fuel)

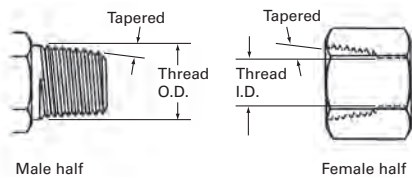

This connection is still widely used in fluid power systems, even though it is not recommended by the National Fluid Power Association (NFPA) for use in hydraulic

applications. The thread is tapered and the seal takes place by deformation of the threads.

NPTF threads

Measure thread diameter and subtract 1/4-inch to find the nominal pipe size.

Inch size	Dash size.	Nominal thread size	Male thread O.D. inch		Female thread I.D. inch	
			Fract.	Dec.	Fract.	Dec.
1/8	02	1/8-27	13/32	0.41	3/8	0.38
1/4	04	1/4-18	17/32	0.54	1/2	0.49
3/8	06	3/8-18	11/16	0.68	5/8	0.63
1/2	08	1/2-14	27/32	0.84	25/32	0.77
3/4	12	3/4-14	1 1/16	1.05	1	0.98
1	16	1-11 1/2	1 5/16	1.32	1 1/4	1.24
1 1/4	20	1 1/4-11 1/2	1 21/32	1.66	1 19/32	0.58
1 1/2	24	1 1/2-11 1/2	1 29/32	1.90	1 13/16	1.82
2	32	2-11 1/2	2 3/8	2.38	2 5/16	2.30

NPSM (National pipe straight mechanical)

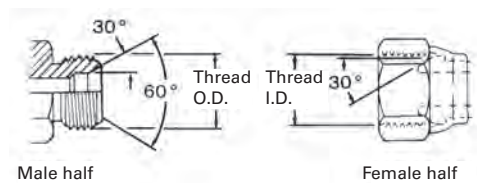

This connection is sometimes used in fluid power systems. The female half has a straight thread and an inverted 30° seat. The male half of the connection has a straight thread and a 30° internal chamfer. The seal takes place

by compression of the 30° seat on the chamfer. The threads hold the connection mechanically.

Note: A properly chamfered NPTF male will also seal with the NPSM female.

NPSM threads

Inch size	Dash size.	Nominal thread size	Male thread O.D. inch		Female thread I.D. inch	
			Fract.	Dec.	Fract.	Dec.
1/8	02	1/8-27	13/32	0.41	3/8	0.38
1/4	04	1/4-18	17/32	0.54	1/2	0.49
3/8	06	3/8-18	11/16	0.68	5/8	0.63
1/2	08	1/2-14	27/32	0.84	25/32	0.77
3/4	12	3/4-14	1 1/16	1.05	1	0.98
1	16	1-11 1/2	1 5/16	1.32	1 1/4	1.24
1 1/4	20	1 1/4-11 1/2	1 21/32	1.66	1 19/32	0.58
1 1/2	24	1 1/2-11 1/2	1 29/32	1.90	1 13/16	1.82
2	32	2-11 1/2	2 3/8	2.38	2 5/16	2.30

Fluid connectors

American connections

A

American connections

SAE J1926 straight thread O-Ring boss (ORB)

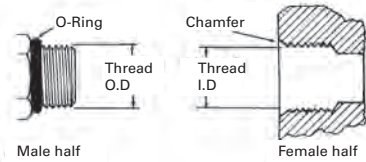

This port connection is recommended by the NFPA for optimum leakage control in medium and high pressure hydraulic systems. The male connector has a straight thread and an O-Ring. The female port has a straight

thread, a machined surface (minimum spotface) and a chamfer to accept the O-Ring. The seal takes place by compressing the O-Ring into the chamfer. The threads hold the connection mechanically.

Inch size	Dash size.	Nominal thread size	Male thread O.D. inch		Female thread I.D. inch	
			Fract.	Dec.	Fract.	Dec.
1/8	02	5/16-24	5/16	0.31	9/32	0.27
3/16	03	3/8-24	3/8	0.38	11/32	0.34
1/4	04	7/16-20	7/16	0.44	13/32	0.39
5/16	05	1/2-20	1/2	0.50	15/32	0.45
3/8	06	9/16-18	9/16	0.56	17/32	0.51
1/2	08	3/4-16	3/4	0.75	3/4	0.69
5/8	10	7/8-14	7/8	0.88	13/16	0.81
3/4	12	1 1/16-12	1 1/16	1.06	1	0.98
7/8	14	1 3/16-12	1 3/16	1.19	1 1/8	1.13
1	16	1 5/16-12	1 5/16	1.31	1 1/4	1.23
1 1/4	20	1 5/8-12	1 5/8	1.63	1 9/16	1.54
1 1/2	24	1 7/8-12	1 7/8	1.88	1 13/16	1.79
2	32	2 1/2-12	2 1/2	2.50	2 7/16	2.42

SAE J514 37° hydraulic

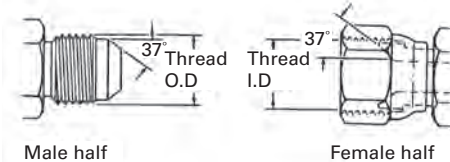

This connection is very common in fluid power systems. Both the male and female halves of the connections have 37° seats. The seal takes place by establishing a line contact between the male flare and the female cone seat.

The threads hold the connection mechanically.

Caution: In the -02, -03, -04, -05, -08 and -10 sizes, the threads of the SAE 45° flare and the SAE 37° flare are the same. However, the sealing surface angles are not the same.

Inch size	Dash size.	Nominal thread size	Male thread O.D. inch		Female thread I.D. inch	
			Fract.	Dec.	Fract.	Dec.
1/8	02	5/16-24	5/16	0.31	9/32	0.27
3/16	03	3/8-24	3/8	0.38	11/32	0.34
1/4	04	7/16-20	7/16	0.44	13/32	0.39
5/16	05	1/2-20	1/2	0.50	15/32	0.45
3/8	06	9/16-18	9/16	0.56	17/32	0.51
1/2	08	3/4-16	3/4	0.75	3/4	0.69
5/8	10	7/8-14	7/8	0.88	13/16	0.81
3/4	12	1 1/16-12	1 1/16	1.06	1	0.98
7/8	14	1 3/16-12	1 3/16	1.19	1 1/8	1.13
1	16	1 5/16-12	1 5/16	1.31	1 1/4	1.23
1 1/4	20	1 5/8-12	1 5/8	1.63	1 9/16	1.54
1 1/2	24	1 7/8-12	1 7/8	1.88	1 13/16	1.79
2	32	2 1/2-12	2 1/2	2.50	2 7/16	2.42

ORS SAE J1453 O-Ring face seal

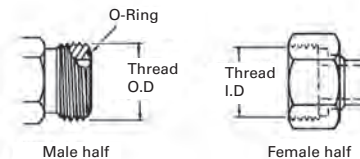

This connection offers the very best leakage control available today. The male connector has a straight thread and an O-Ring in the face. The female has a straight thread and a machined flat face.

The seal takes place by compressing the O-Ring onto the flat face of the female, similar to the split flange type fitting. The threads hold the connection mechanically.

Inch size	Dash size.	Nominal thread size	Male thread O.D. inch		Female thread I.D. inch	
			Fraction	Decimal	Fraction	Decimal
1/4	04	9/16-18	9/16	0.56	17/32	0.51
3/8	06	11/16-16	11/16	0.69	5/8	0.63
1/2	08	13/16-16	13/16	0.82	3/4	0.75
5/8	10	1-14	1	1.00	15/16	0.93
3/4	12	1 3/16-12	1 3/16	1.19	1 1/8	1.11
1	16	1 7/16-12	1 7/16	1.44	1 3/8	1.36
1 1/4	20	1 11/16-12	1 11/16	1.69	1 5/8	1.61
1 1/2	24	2-12	2	2.00	1 15/16	1.92

American connections

SAE J512 inverted flare

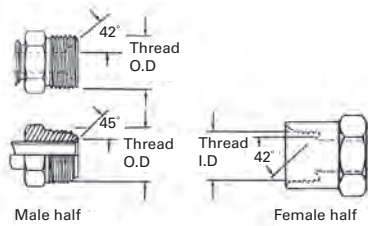

This connection is frequently used in automotive systems. The male connector can either be a 45° flare in the tube fitting form or a 42° seat in the machined adapter form.

The female has a straight thread with a 42° inverted flare. The seal takes place on the flared surfaces. The threads hold the connection mechanically.

Inch size	Dash size	Nominal thread size	Male thread O.D. inch		Female thread I.D. inch	
			Fract.	Dec.	Fract.	Dec.
1/8	02	5/16-24	5/16	0.32	9/32	0.28
3/16	03	3/8-24	3/8	0.38	11/32	0.34
1/4	04	7/16-24	7/16	0.44	13/32	0.40
5/16	05	1/2-20	1/2	0.50	15/32	0.45
3/8	06	5/8-18	5/8	0.63	9/16	0.57
7/16	07	11/16-18	11/16	0.69	5/8	0.63
1/2	08	3/4-18	3/4	0.75	23/32	0.70
5/8	10	7/8-18	7/8	0.88	13/16	0.82
3/4	12	1 1/16-16	1 1/16	1.06	1	1.00

SAE J512 45°

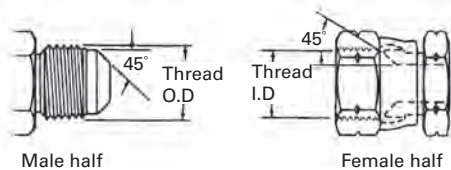

This connection is commonly used in refrigeration, automotive and truck piping systems. The connector is frequently made of brass. Both the male and female connectors have 45° seats. The seal takes place between the male flare the female cone seat.

The threads hold the connection mechanically.

Caution: In the -02, -03, -04, -05, -08 and -10 sizes, the threads of the SAE 45° flare and the SAE 37° flare are the same. However, the sealing surface angles are not the same.

Inch size	Dash size	Nominal thread size	Male thread O.D. inch		Female thread I.D. inch	
			Fract.	Dec.	Fract.	Dec.
1/8	02	5/16-24	5/16	0.31	9/32	0.27
3/16	03	3/8-24	3/8	0.38	11/32	0.34
1/4	04	7/16-20	7/16	0.44	13/32	0.39
5/16	05	1/2-20	1/2	0.50	15/32	0.45
3/8	06	5/8-18	5/8	0.63	9/16	0.57
1/2	08	3/4-16	3/4	0.75	11/16	0.69
5/8	10	7/8-14	7/8	0.88	13/16	0.81
3/4	12	1 1/16-14	1 1/16	1.06	1	0.99
7/8	14	1 1/4-12	1 1/4	1.25	1 5/32	1.16
1	16	1 3/8-12	1 3/8	1.38	1 9/32	1.29

Staplok (SAE J1467)

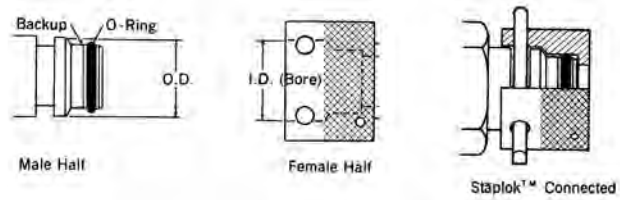

This is a radial O-Ring seal connection developed in Germany and commonly used for hydraulic application in underground mines. The male contains an exterior O-Ring and backup ring, plus a groove to accept the "staple". The female has a smooth bore

with two holes for the staple. A "U" shaped retaining clip or staple is inserted through the two holes, passing through the groove in the male to lock the connection together. The seal takes place by contact between the O-Ring in the male and the smooth bore of the female.

Inch size	Dash size	Nominal thread size	Male thread O.D. inch		Female thread I.D. inch	
			Fraction	Decimal	Fraction	Decimal
1/4	04	-	9/32	0.586	1 9/32	0.597
3/8	06	-	25/32	0.783	51/64	0.794
1/2	08	-	15/16	0.940	61/64	0.951
3/4	12	-	1 9/64	1.137	1 9/64	1.148
1	16	-	1 17/32	1.529	1 35/64	1.540
1 1/4	20	-	1 13/16	1.806	1 13/16	1.817
1 1/2	24	-	2 5/32	2.163	2 11/64	2.174
2	32	-	2 33/64	2.517	2 17/32	2.528

Fluid connectors

American connections

A

American connections

How to measure 4-Bolt Flange

First measure the port hole diameter using the caliper. Next, measure the longest bolt hole spacing from center-to-center (Dimension "A") or measure the flanged head diameter.

SAE J518 Code 61/62 4-Bolt Flange*

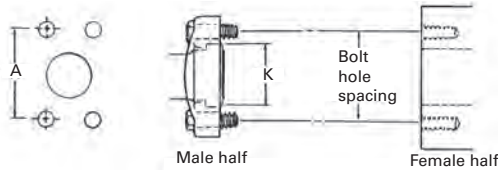

This connection is commonly used in fluid power systems. There are two pressure ratings. Code 61 is referred to as the "standard" series and Code 62 is the "6000 psi" series. The design concept for both series is the same, but the bolt hole spacing and flanged head diameters are larger for the higher pressure, Code 62 connection. The female (port) is an unthreaded hole with four bolt holes in a rectangular pattern around

the port. The male consists of a flanged head, grooved for an O-Ring, and either a captive flange or split flange halves with bolt holes to match the port. The seal takes place on the O-Ring, which is compressed between the flanged head and the flat surface surrounding the port. The threaded bolts hold the connection together.

* SAE J518, JIS B 8363, ISO/ DIS 6162 and DIN 20066 are interchangeable, except for bolt sizes.

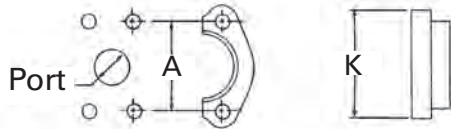

Inch Size (dash size)	Port hole I.D. inch fract. (dec.)	Bolt dimension inch		Bolt hole spacing "A" inch (dec.)		Flanged head dia. "K" inch (dec.)	
		Cd. 61	Cd. 62	Cd. 61	Cd. 62	Cd. 61	Cd. 62
1/2 (08)	1/2 (0.50)	5/16-18x1-1/4	5/16-18x1-1/4	1-1/2 (1.50)	1-19/32 (1.59)	1-3/16 (1.19)	1-1/4 (1.25)
3/4 (12)	3/4 (0.75)	3/8-16x1-1/4	3/8-16x1-1/2	1-7/8 (1.88)	2.00 (2.00)	1-1/2 (1.50)	1-5/8 (1.63)
1.00 (16)	1.00 (1.00)	3/8-16x1-1/4	7/16-14x1-3/4	2-1/16 (2.06)	2 1/4 (2.25)	1-3/4 (1.75)	1-7/8 (1.88)
1-1/4 (20)	1-1/4 (1.25)	7/16-14x1-1/2	1/2-13x1-3/4	2-5/16 (2.31)	2-5/8 (2.63)	2.00 (2.00)	2-1/8 (2.13)
1-1/2 (24)	1-1/2 (1.50)	1/2-13x1-1/2	5/8-11x2-1/4	2-3/4 (2.75)	3-1/8 (3.12)	2-3/8 (2.38)	2-1/2 (2.50)
2.00 (32)	2.00 (2.00)	1/2-13x1-1/2	3/4-10x2-3/4	3-1/16 (3.06)	3-13/16 (3.81)	2-13/16 (2.81)	3-1/8 (3.12)

ISO 6149 Port and Stud Ends with ISO 261 Threads and O-Ring Seal

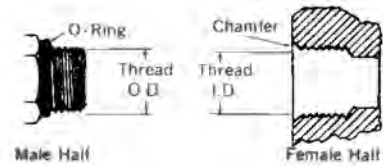

This port connection is similar to the SAE J514 Straight Thread O-Ring Boss (ORB). The major difference is that this connection uses metric threads. The male connector has a straight thread and an O-Ring. The female port has

a straight thread, a machined surface (minimum spotface) and a chamfer to accept the O-Ring. The seal takes place by compressing the O-Ring into the chamfer. The threads hold the connection mechanically.

Metric thread	Male thread O.D.	Female thread I.D.
	mm	mm
M8 x 1	8	7
M10 x 1	10	9
M12 x 1,5	12	10,5
M14 x 1,5*	14	12,5
M16 x 1,5	16	14,5
M18 x 1,5	18	16,5
M22 x 1,5	22	20,5
M27 x 2	27	25
M33 x 2	33	31
M42 x 2	42	40
M48 x 2	48	46
M60 x 2	60	58

* M14 x 1,5: Recommended for diagnostic port application.

ISO connections

ISO/DIS 6162 4-Bolt Flange*

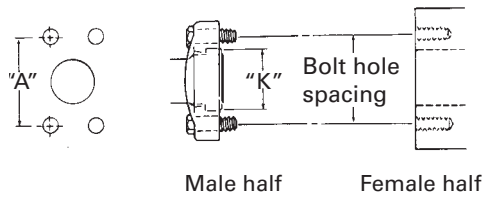

This connection is commonly used in fluid power systems. There are two pressure ratings. PN 35/350 bar (Code 61) is the "standard" series and PN 415 bar (Code 62) is the high pressure series. The design concept for both series is the same, but the bolt hole spacing and flanged head diameters are larger for the higher pressure, PN 415 bar connection. Both metric and inches bolts are used. The port will have an "M" stamped on it if metric bolts are required.

The female (port) is an unthreaded hole with four bolt holes in a rectangular pattern around the port. The male consists of a flanged head, grooved for an O-Ring, and either a captive flange or split flange halves with bolt holes to match the port. The seal takes place on the O-Ring, which is compressed between the flanged head and the flat surface surrounding the port. The threaded bolts hold the connection together.

* ISO/DIS 6162, DIN 20066, JIS B 8363 and SAE J518 are interchangeable, except for bolt sizes.

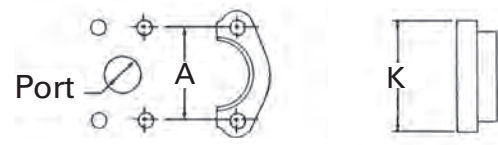

Inch size	Flanged head dia. "K"			
	ISO 6162-1 Bar (Cd.61)		ISO 6162-2 Bar (Cd.62)	
	mm	in	mm	in
1/2	30.18	1.19	31.75	1.25
3/4	38.10	1.50	41.28	1.63
1	44.45	1.75	47.63	1.88
1 1/4	50.80	2.00	53.98	2.13
1 1/2	60.33	2.38	63.50	2.50
2	71.42	2.81	79.38	3.13

Size	Port hole	Bolt dimensions spacing		Bolt hole "A"	
		ISO 6162-1 Bar (Cd.61)	ISO 6162-2 Bar (Cd.62)	ISO 6162-1 Bar (Cd.61)	ISO 6162-2 Bar (Cd.62)
mm in (dash)	mm (in)	mm (in)	mm (in)	mm (in)	mm (in)
13(1/2) (08)	12,7 (.50)	M8 x 1.25x 30 (5/16-18 x 1 1/4)	M8 x 1.25 x 30 (5/16-18 x 1 1/4)	38.1 (1.50)	40.5 (1.57)
19(3/4) (12)	19,1 (.75)	M10 x 1.5 x 35 (3/8-16 x 1 1/4)	M10 x 1.5 x 40 (3/8-16 x 1 1/2)	47.6 (1.88)	50.8 (2.00)
25(1) (16)	25,4 (1.00)	M10 x 1.5 x 35 (3/8-16 x 1 1/4)	M12 x 1.75 x 45 (7/16-14 x 1 3/4)	52.4 (2.06)	57.2 (2.25)
32(1 1/4) (20)	31,8 (1.25)	M10 x 1.5 x 40 (7/16-14 x 1 1/2)	M14 x 2 x 50 (1/2-13 x 1 3/4)	58.7 (2.31)	66.7 (2.63)
38(1 1/2) (24)	38,1 (1.50)	M12 x 1.75 x 40 (1/2-13 x 1 1/2)	M16 x 2 x 55 (5/8-11 x 2 1/4)	69.9 (2.75)	79.4 (3.13)
51(2) (32)	50,8 (2.00)	M12 x 1.75 x 40 (1/2-13 x 1 1/2)	M20 x 2.5 x 70 (3/4-10 x 2 3/4)	77.8 (3.06)	96.8 (3.81)

Fluid connectors

German connections

A

German connections

Metric 30° (DIN 7631)

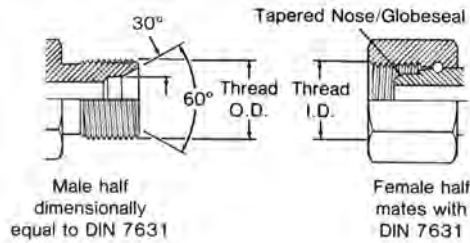

This connection is frequently used in hydraulic systems. The male has a straight metric thread and a 60° (included angle) recessed cone. The female has a straight thread and a tapered Nose/Globeseal seat. The seal takes place

by contact between the cone of the male and the nose of the tapered Nose/Globeseal flareless swivel.

The threads hold the connection mechanically.

Metric 24° (DIN 3902)

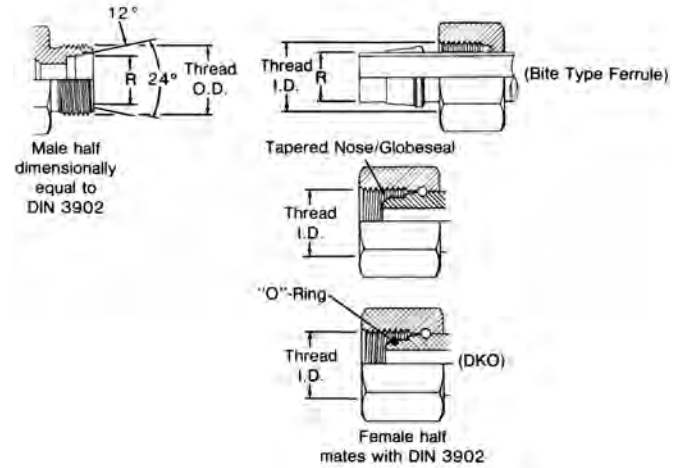

This connection style consists of a common male and three different female halves. The male has a straight metric thread, a 24° included angle and a recessed counterbore that matches the tube O.D. used with it. The female may

be a tube, nut and ferrule, a tapered nose/Globeseal flareless swivel or a tapered Nose/Globeseal flareless swivel with an O-Ring in the Nose (DKO type).

Use with pipe/tube O.D.		Metric thread size	Male thread O.D.		Female thread I.D.	
mm	in		mm	in	mm	in
6	0.24	M12 x 1.5	12	0.47	10,5	0.41
8	0.32	M14 x 1.5	14	0.55	12,5	0.49
10	0.39	M16 x 1.5	16	0.63	14,5	0.57
12	0.47	M18 x 1.5	18	0.71	16,5	0.65
15	0.59	M22 x 1.5	22	0.87	20,5	0.81
18	0.71	M26 x 1.5	26	1.02	24,5	0.96
22	0.87	M30 x 1.5	30	1.18	28,5	1.12
28	1.10	M38 x 1.5	38	1.50	36,5	1.44
35	1.38	M45 x 1.5	45	1.77	43,5	1.71
42	1.65	M52 x 1.5	52	2.04	50,5	1.99

Tube O.D. "R" Dim. l.Rh.*		Tube O.D. "R" Dim. s.Rh.†		Metric thread Size	Male thread O.D.		Female thread I.D.	
mm	in.	mm	in		mm	in	mm	in
6	0.24	-	-	M12 x 1.5	12	0.47	10.5	0.41
8	0.32	6	0.24	M14 x 1.5	14	0.55	12.5	0.49
10	0.39	8	0.32	M16 x 1.5	16	0.63	14.5	0.57
12	0.47	10	0.39	M18 x 1.5	18	0.71	16.5	0.65
-	-	12	0.47	M20 x 1.5	20	0.78	18.5	0.73
15	0.59	14	0.55	M22 x 1.5	22	0.87	20.5	0.81
-	-	16	0.63	M24 x 1.5	24	0.94	22.5	0.89
18	0.71	-	-	M26 x 1.5	26	1.02	24.5	0.96
22	0.87	20	0.78	M30 x 2.0	30	1.18	28	1.11
28	1.10	25	0.98	M36 x 2.0	36	1.41	34	1.34
-	-	30	1.18	M42 x 2.0	42	1.65	40	1.57
35	1.38	-	-	M45 x 2.0	45	1.77	43	1.70
42	1.65	38	1.50	M52 x 2.0	52	2.04	50	1.97

*l.Rh. is a light duty system.
†s.Rh. is a heavy duty system.

German connections

DIN 20066 4-bolt flange*

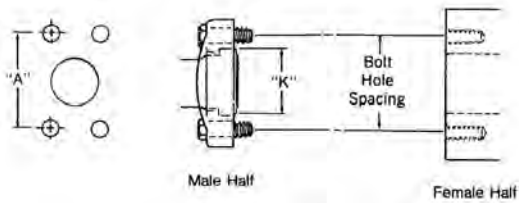

This connection is commonly used in fluid power systems. There are two pressure ratings. Form R (Code 61) is referred to as the “standard duty” series and Form S (Code 62) is the “heavy duty” series. The design concept for both series is the same, but the bolt hole spacing and flanged head diameters are larger for the higher pressure,

Form S connection. Both metric and inch bolts are used. The female (port) is an unthreaded hole with four bolt holes in a rectangular pattern around the port. The male consists of a flanged head, grooved for an O-Ring, and either a captive flange or split flange halves with bolt holes to match the port. The seal takes place on the O-Ring,

which is compressed between the flanged head and the flat surface surrounding the port. The threaded bolts hold the connection together.

Note: *DIN 20066, IS/DIS 6166, JIS B 8363 and SAE J518 are interchangeable, except for bolt sizes.

Size	Port hole	Bolt dimensions		Bolt hole spacing	
		Form R (Cd. 61)	Form S (Cd. 62)	Form R (Cd. 61)	Form S (Cd. 62)
mm (inch) (dash)	mm (in)	-	-	mm (in)	mm (in)
12 (1/2) (08)	12,7 (0.50)	M8 x 1.25 x 30 5/16-18 x 1 1/4	M8 x 1.25 x 30 5/16-18 x 1 1/4	38.10 (1.50)	40.49 (1.57)
20 (3/4) (12)	19,1 (0.75)	M10 x 1.5 x 30 3/8-16 x 1 1/4	M10 x 1.5 x 40 3/8-16 x 1 1/2	47.63 (1.88)	50.80 (2.00)
25 (1) (16)	25,4 (1.00)	M10 x 1.5 x 35 3/8-16 x 1 1/4	M12 x 1.75 x 45 7/16-14 x 1 3/4	52.37 (2.06)	57.15 (2.25)
32 (1-1/4) (20)	31,7 (1.25)	M10 x 1.75 x 40 7/16-14 x 1 1/2	M14 x 2 x 45 1/2-13 x 1 3/4	58.72 (2.31)	66.68 (2.63)
40 (1-1/2) (24)	38,0 (1.50)	M12 x 1.75 x 40 1/2-13 x 1 1/2	M16 x 2 x 55 5/8-11 x 2 1/4	69.85 (2.75)	79.38 (3.13)
50 (2) (32)	50,8 (2.00)	M12 x 1.75 x 40 1/2-13 x 1 1/2	M20 x 2.5 x 70 3/4-10 x 2 3/4	77.77 (3.06)	96.82 (3.81)

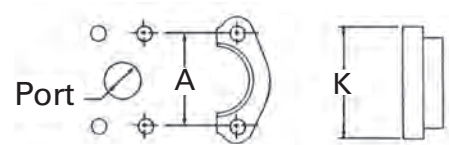

Inch size	Flanged head dia. "K"			
	Form R (Cd. 61)		Form S (Cd. 62)	
	mm	in	mm	in
1/2	30.18	1.19	31.75	1.25
3/4	38.10	1.50	41.28	1.63
1	44.45	1.75	47.63	1.88
1 1/4	50.80	2.00	53.98	2.13
1 1/2	60.33	2.38	63.50	2.50
2	71.42	2.81	79.38	3.13

Fluid connectors

German connections

A

German connections

DIN 3852 Male connectors and female ports

DIN 3852 metric threads

Metric thread	Male thread O.D. "A"		Female thread I.D. "B"	
	mm	(in)	mm	(in)
M12 x 1.5	12	0.47	10,5	0.41
M14 x 1.5	14	0.55	12,5	0.49
M16 x 1.5	16	0.63	14,5	0.57
M18 x 1.5	18	0.71	16,5	0.65
M20 x 1.5	20	0.78	18,5	0.73
M22 x 1.5	22	0.87	20,5	0.81
M24 x 1.5	24	0.94	22,5	0.89
M26 x 1.5	26	1.02	24,5	0.96
M27 x 2	27	1.06	25	0.98
M30 x 1.5	30	1.18	28,5	1.12
M30 x 2	30	1.18	28	1.10
M33 x 2	33	1.30	31	1.22
M36 x 1.5	36	1.41	34,5	1.36
M36 x 2	36	1.41	34	1.33
M38 x 1.5	38	1.49	36,5	1.43
M38 x 2	38	1.49	36	1.41
M42 x 1.5	42	1.65	40,5	1.60
M42 x 2	42	1.65	40	1.57
M45 x 1.5	45	1.77	43,5	1.71
M45 x 2	45	1.77	43	1.69
M48 x 1.5	48	1.89	46,5	1.83
M48 x 2	48	1.89	46	1.81
M52 x 1.5	52	2.04	50,5	1.89
M52 x 2	52	2.04	50	1.97

For DIN 3852 Whitworth pipe thread dimensions, see BSPT/BSPP dimensions. They are the same.

How the seal works

This DIN is controlled by Germany, but other countries may use it as a reference for their connector and port designs. The chart below illustrates the various forms and how they seal.

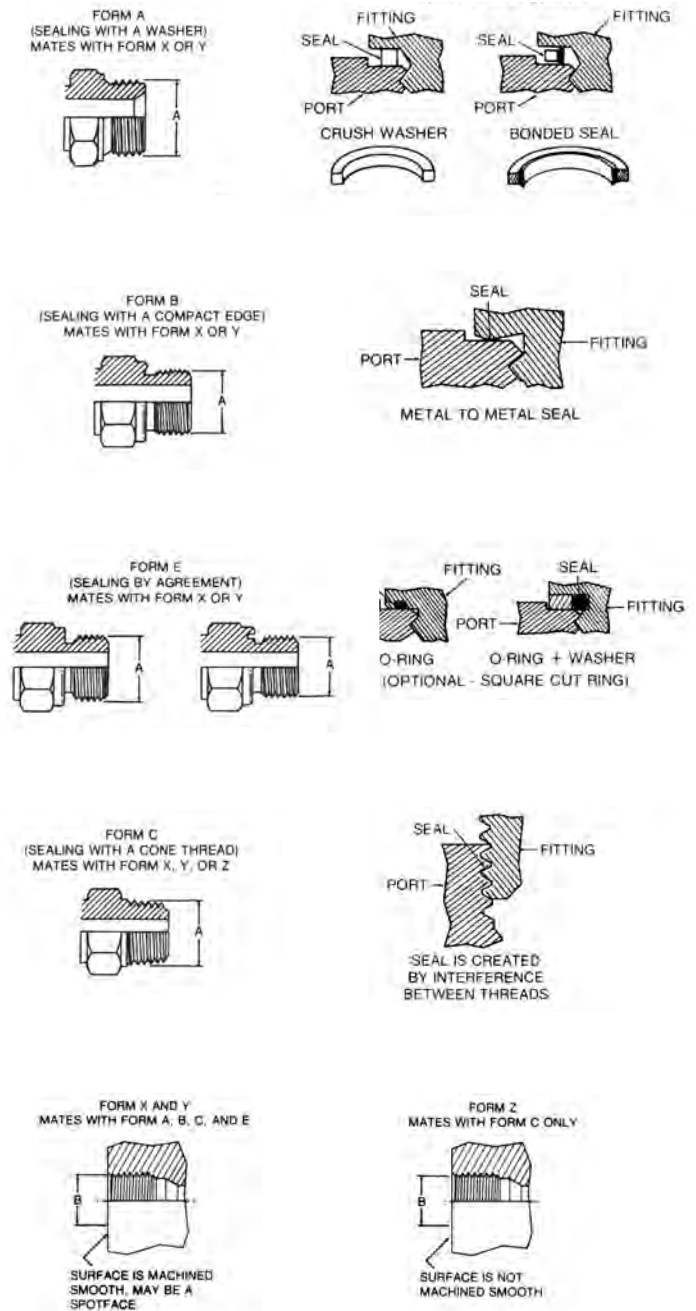

French connections

Millimetrique and GAZ series

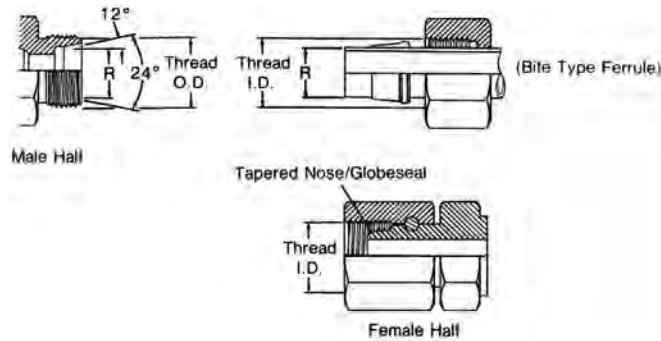

This connection consists of a common male and two different females. The millimetric series is used with

whole number metric O.D. tubing and the GAZ Series is used with fractional number metric O.D. pipe size tubing.

British connections

British standard pipe (BSP/BSPP/BSPT)

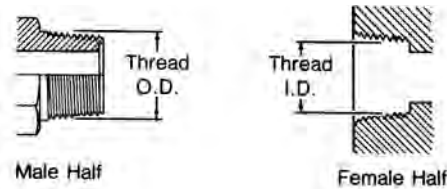

This BSPT (tapered) connection is similar to the NPT, except that the thread pitches are different in most sizes, and the thread

form and O.D.s are close but not the same. Sealing is accomplished by thread distortion. A thread sealant is recommended.

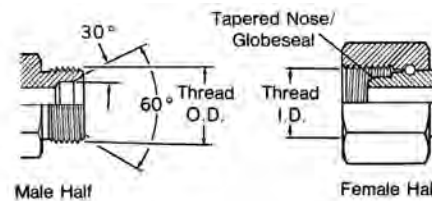

The BSP (parallel) male is similar to the NPSM male except the thread pitches are different in most sizes.

The female swivel BSPP has a tapered nose/Globeseal flareless swivel which seals on the cone seat of the male.

Millimetric and GAZ threads

Tubing O.D. "R" dim.		"Gaz" pipe O.D. "R" dim.		Metric thread	Male Thread O.D. "A"		Female Thread I.D. "B"	
mm	in	mm	in		mm	in	mm	in
6	0.24	-	-	M12 x 1.5	12	0.47	11	0.43
8	0.32	-	-	M14 x 1.5	14	0.55	12.5	0.49
10	0.39	-	-	M16 x 1.5	16	0.63	14.5	0.57
12	0.47	-	-	M18 x 1.5	18	0.71	16.5	0.65
14	0.55	13.25	0.52	M20 x 1.5	20	0.78	18.5	0.73
15	0.59	-	-	M22 x 1.5	22	0.87	20.5	0.81
16	0.63	16.75	0.66	M24 x 1.5	24	0.94	22.5	0.89
18	0.71	-	-	M27 x 1.5	27	1.06	25.5	1.00
22	0.87	21.25	0.83	M30 x 1.5	30	1.18	28.5	1.12
25	0.98	-	-	M33 x 1.5	33	1.30	31.5	1.24
28	1.10	26.75	1.05	M36 x 1.5	36	1.41	34.5	1.36
30	1.18	-	-	M39 x 1.5	39	1.54	37.5	1.48
32	1.25	-	-	M42 x 1.5	42	1.65	40.5	1.60
35	1.38	33.50	1.32	M45 x 1.5	45	1.77	43.5	1.71
38	1.50	-	-	M48 x 1.5	48	1.89	46.5	1.83
40	1.57	42.25	1.66	M52 x 1.5	52	2.04	50.5	1.99
45	1.77	-	-	M54 x 2.0	54	2.12	52	2.05
-	-	48.25	1.90	M58 x 2.0	58	2.28	55	2.16

BSPT/BSPP threads

Inch size	Dash size	Nominal thread size	Male thread O.D.		Female thread I.D.	
			fraction	decimal	fraction	decimal
1/8	02	1/8-28	3/8	0.38	11/32	0.35
1/4	04	1/4-19	33/64	0.52	15/32	0.47
3/8	06	3/8-19	21/32	0.65	19/32	0.60
1/2	08	1/2-14	13/16	0.82	3/4	0.75
5/8	10	5/8-14	7/8	0.88	13/16	0.80
3/4	12	3/4-14	1 1/32	1.04	31/32	0.97
1	16	1-11	1 5/16	1.30	1 7/32	1.22
1 1/4	20	1 1/4-11	1 21/32	1.65	1 9/16	1.56
1 1/2	24	1 1/2-11	1 7/8	1.88	1 25/32	1.79
2	32	2-11	2 11/32	2.35	2 1/4	2.26

*Frequently, the thread size is expressed as a fractional dimension preceded by the letter "G" or the letter "R". The "G" represents a parallel thread and the "R" indicates a tapered thread. For example, BSPP 3/8-19 may be expressed as G 3/8, and BSPT 3/8-19 may be expressed as R3/8.

Fluid connectors

Japanese connections

A

Japanese connections

JIS 30° male inverted seat, parallel pipe threads

(Threads per JIS B 0202)

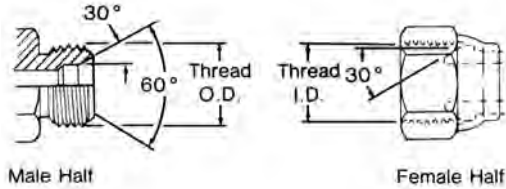

The JIS parallel is similar to the BSPP connection.

The JIS parallel thread and the BSPP connection are interchangeable.

Inch size	Dash size	Nominal thread size (similar to BSPP)	Male thread O.D.		Female thread O.D.	
			fract.	mm	fract.	mm
1/4	6 (04)	-	33/64	13.2	15/32	11.9
3/8	9 (06)	3/8-19	21/32	16.7	19/32	15.3
1/2	12 (08)	1/2-14	13/16	21.0	3/4	19.2
3/4	19 (12)	3/4-14	1 1/32	26.4	31/32	24.6
1	25 (16)	1-11	1 5/16	33.3	1 7/32	30.9
1 1/4	32 (20)	1 1/4-11	1 21/32	41.9	1 9/16	39.6
1 1/2	38 (24)	1 1/2-11	1 7/8	47.8	1 25/32	45.5
2	50 (32)	2-11	2 11/32	59.7	2 1/4	57.4

JIS 30° male inverted seat, parallel pipe threads

(Threads per JIS B 0207)

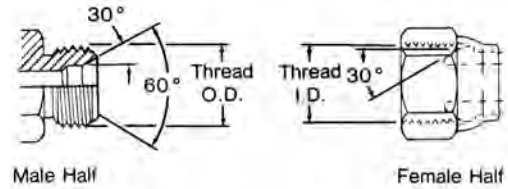

The JIS parallel (metric) is the same as the JIS parallel

(PF), except for the thread difference.

Inch size	Dash size equivalent	Thread size	Male thread O.D.		Female thread O.D.	
			mm	dec.	mm	dec.
6	04	M14 x 1.5	14	0.55	12.5	0.49
9	06	M18 x 1.5	18	0.71	16.5	0.65
12	08	M22 x 1.5	22	0.87	20.5	0.81
19	12	M30 x 1.5	30	1.18	28.5	1.12
25	16	M33 x 1.5	33	1.30	31.5	1.24
32	20	M42 x 1.5	42	1.65	40.5	1.60

JIS Tapered pipe (PT)

(Threads per JIS B 0203)

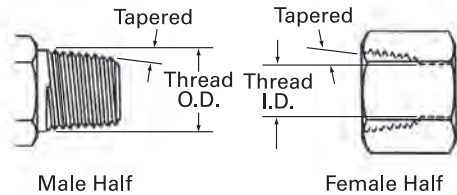

The JIS tapered thread is similar to the BSPT connection in design, appearance and dimensions.

The JIS tapered thread and the BSPT connection are interchangeable.

Inch size	Dash size	Nominal thread size (similar to BSPP)	Male thread O.D.		Female thread I.D.	
			fract.	mm.	fract.	mm
1/4	6 (04)	1/4-19	33/64	13.2	15/32	11.9
3/8	9 (06)	3/8-19	21/32	16.7	19/32	15.3
1/2	12 (08)	1/2-14	13/16	21.0	3/4	19.2
3/4	19 (12)	3/4-14	1 1/32	26.4	31/32	24.6
1	25 (16)	1-11	1 5/16	33.3	1 7/32	30.9
1 1/4	32 (20)	1 1/4-11	1 21/32	41.9	1 9/16	39.6
1 1/2	38 (24)	1 1/2-11	1 7/8	47.8	1 25/32	45.5
2	50 (32)	2-11	2 11/32	59.7	2 1/4	57.4

JIS 30° female (cone) seat, parallel pipe threads (PT)

(Threads per JIS B 0202)

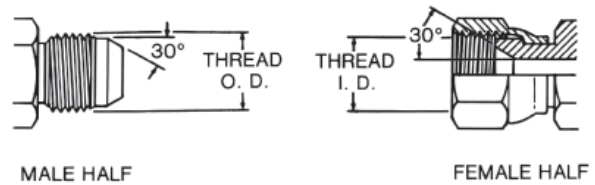

The Japanese JIS 30° flare is similar to the American SAE 37° flare connection in application as well as sealing

principles. However, the flare angle and dimensions are different. The threads are similar to BSPP.

Inch size	Dash size	Nominal thread size (similar to BSPP)	Male thread O.D.		Female thread O.D.	
			fract.	mm	fract.	mm
1/4	6 (04)	1/4-19	33/64	13.2	15/32	11.9
3/8	9 (06)	3/8-19	21/32	16.7	19/32	15.3
1/2	12 (08)	1/2-14	13/16	21.0	3/4	19.2
3/4	19 (12)	3/4-14	1 1/32	26.4	31/32	24.6
1	25 (16)	1-11	1 5/16	33.3	1 7/32	30.9
1 1/4	32 (20)	1 1/4-11	1 21/32	41.9	1 9/16	39.6
1 1/2	38 (24)	1 1/2-11	1 7/8	47.8	1 25/32	45.5
2	50 (32)	2-11	2 11/32	59.7	2 1/4	57.4

Japanese connections

JIS B 8363 4-bolt flange*

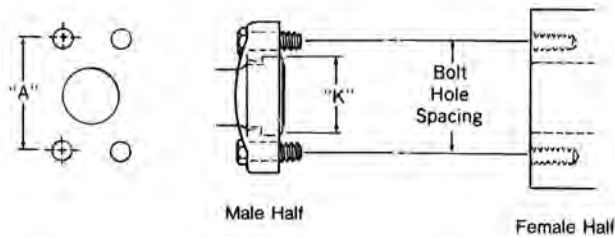

This connection is commonly used in fluid power systems. There are two pressure ratings. Type I (Code 61) is referred to as the “standard” series and Type II (Code 62) is the “6000 psi” series. The design concept for both series is the

same, but the bolt hole spacing and flanged head diameters are larger for the higher pressure, Type II connection. Both metric and inch bolts are used. The female (port) is an unthreaded hole with four bolt holes in a rectangular pattern

around the port. The male consists of a flanged head, grooved for an O-Ring, and either a captive flange or split flange halves with bolt holes to match the port. The seal takes place on the O-Ring, which is compressed between

the flanged head and the flat surface surrounding the port. The threaded bolts hold the connection together.

Note: *JIS B 8363, ISO/DIS 6162, DIN 20066, and SAE J518 are interchangeable, except for bolt sizes.

Size	Port hole	Bolt dimensions		Bolt hole spacing "A"	
		Type I (Cd.61)	Type II (Cd. 62)	Type I (Cd. 61)	Type II (Cd. 62)
mm (in) (dash)	mm (in)	mm (in)	mm (in)	mm (in)	mm (in)
12 (1/2) (08)	12,7 (0.50)	M8 x 1.25 x 30 (5/16-18 x 1 1/4)	M8 x 1.25 x 30 (5/16-18 x 1 1/4)	38.1 (1.50)	40.49 (1.57)
19 (3/4) (12)	19,1 (0.75)	M10 x 1.5 x 30 (3/8-16 x 1 1/4)	M10 x 1.5 x 40 (3/8-16 x 1 1/2)	47.63 (1.88)	50.80 (2.00)
25 (1) (16)	25,4 (1.00)	M10 x 1.5 x 30 (3/8-16 x 1 1/4)	M12 x 1.75 x 45 (7/16-14 x 1 3/4)	52.37 (2.06)	57.15 (2.25)
32 (1 1/4) (20)	31,7 (1.25)	M10 x 1.5 x 40 (7/16-14 x 1 1/2)	M14 x 2 x 45 (1/2-13 x 1 3/4)	58.72 (2.31)	66.68 (2.63)
38 (1 1/2) (24)	38,0 (1.50)	M12 x 1.75 x 40 (1/2-13 x 1 1/2)	M16 x 2 x 55 (5/8-11 x 2 1/4)	69.85 (2.75)	79.38 (3.13)
50 (2) (32)	50,8 (2.00)	M12 x 1.75 x 40 (1/2-13 x 1 1/2)	M20 x 2.5 x 70 (3/4-10 x 2 3/4)	77.77 (3.06)	96.82 (3.81)

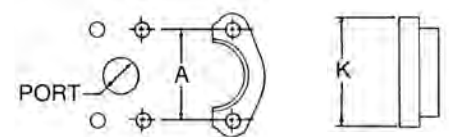

Size	Flanged head dia. "K"				
	Type I bar (Cd.61)		Type II bar (Cd. 62)		
in	mm	in	mm	in	
1/2	30,18	1.19	31,75	1.25	
3/4	38,10	1.50	41,28	1.63	
1	44,45	1.75	47,63	1.88	
1 1/4	50,80	2.00	53,98	2.13	
1 1/2	60,33	2.38	63,50	2.50	
2	71,42	2.81	79,38	3.13	

Fluid connectors

Japanese connections

A

Japanese connections

JIS 210 Kgf/cm² 4-bolt square flange

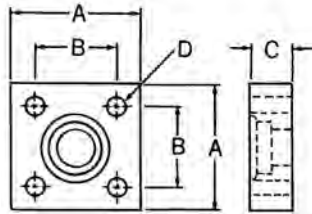

The JIS 4-bolt square flange connection is similar in concept to the SAE 4-bolt flange connection, except that

the JIS bolt pattern is square and the flange itself is different.

Size mm	Appx. inch size	Bolt size mm (bolt length for long design)	Dim. "A" mm (inch)	Dim. "B" mm (inch)	Dim. "C" mm (inch)	Bolt hole dia "D" mm (inch)
12	1/2	M10 x 1.5 x 55 (80)	63 (2.48)	40 (1.57)	22 (0.87)	11 (0.43)
19	3/4	M10 x 1.5 x 55 (80)	68 (2.67)	45 (1.77)	22 (0.87)	11 (0.43)
25	1	M12 x 1.75 x 70 (100)	80 (3.15)	53 (2.09)	28 (1.10)	13 (0.51)
32	1 1/4	M12 x 1.75 x 70 (100)	90 (3.54)	63 (2.48)	28 (1.10)	13 (0.51)
38	1 1/2	M16 x 2.0 x 90 (130)	100 (3.94)	70 (2.76)	36 (1.42)	18 (0.71)
50	2	M16 x 2.0 x 90 (130)	112 (4.41)	80 (3.15)	36 (1.42)	18 (0.71)

Komatsu 30° flare

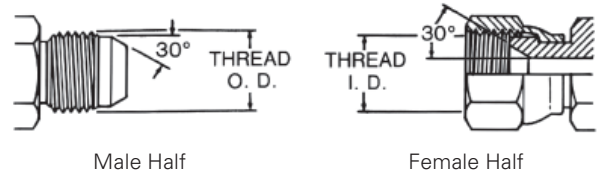

The Japanese Komatsu 30° flare is similar to the American SAE 37° flare connection in application as well as sealing

principles. However, the flare angle and dimensions are different. The threads are metric.

Komatsu Nominal size mm	Eaton equivalent	Komatsu Thread
02	04	M14 x 1.5
03	06	M18 x 1.5
04	08	M22 x 1.5
05	10	M24 x 1.5
06	12	M30 x 1.5
10	16	M33 x 1.5
12	20	M36 x 1.5
14	24	M42 x 1.5

JIS 210 Kgf/cm² O-ring

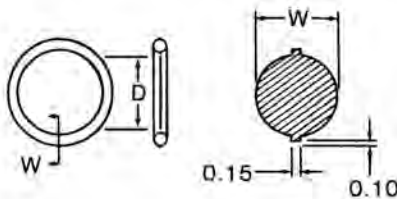

Nominal size mm	Dim. "D" mm	Dim. "W" mm
12	24.4 ± 0.15	3.1 ± 0.1
19	29.4 ± 0.15	3.1 ± 0.1
25	34.4 ± 0.15	3.1 ± 0.1
32	39.4 ± 0.15	3.1 ± 0.1
38	49.4 ± 0.15	3.1 ± 0.1
50	59.4 ± 0.15	3.1 ± 0.1

O-Ring pilot thread sizes

This connection is common to air conditioning systems, both in vehicle and commercial applications. Both the male and female halves of the connections have a pilot, either long or short. The seal takes place by compressing an O-ring adjacent to the bead of the tube. The threads hold the connection together mechanically.

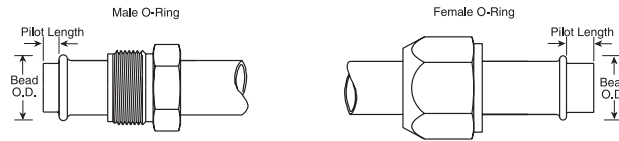

Inch size	Dash size	Male thread			Female thread		
		O.D. (inch) nominal thread	O.D. (inch) fraction	O.D. (inch) decimal	I.D. (inch) nominal thread	I.D. (inch) fraction	I.D. (inch) decimal
3/8	06	5/8 - 18	5/8	0.62	5/8 - 18	9/16	0.57
1/2	08	3/4 - 18	3/4	0.75	3/4 - 16	11/16	0.69
5/8	10	7/8 - 18	7/8	0.87	7/8 - 14	13/16	0.81
3/4	12	1 1/16 - 16	1 1/16	1.06	1 1/16 - 14	1	0.99

Inch size	Nominal tube size	Long pilot		Short pilot	
		Bead O.D. (inch)	Pilot length	Bead O.D. (inch)	Pilot length
3/8	06	0.52	0.28	0.52	0.19
1/2	08	0.64	0.39	0.64	0.19
5/8	10	0.77	0.39	0.77	0.19
3/4	12	0.91	0.39	0.91	0.19

Fluid connector

Thread engagement nominal dimensions

A

Thread engagement

Dimensions may vary due to tolerance conditions.

Listed below are the thread engagement dimensions (B) which must be taken into consideration when making connection with ports or appropriate female adapters. The "B" dimension must be subtracted from the overall length (A) to insure proper connection.

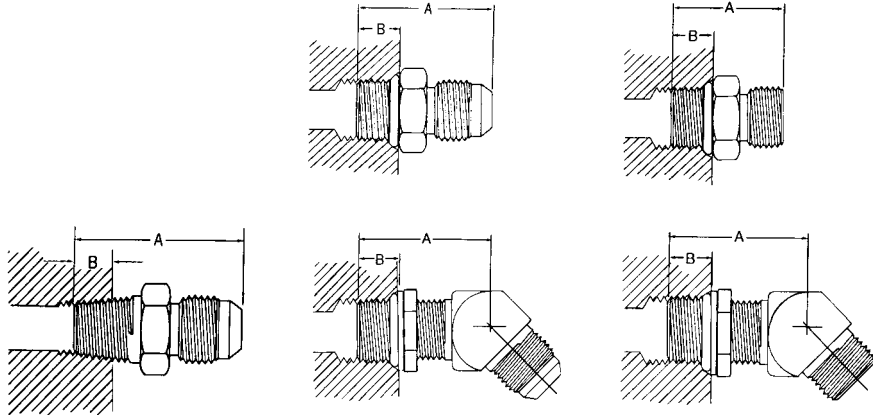

Dash size	Male pipe		SAE O-ring boss SAE J1926 with SAE 37° flare J514		SAE O-ring boss SAE J1926 with ORS J1453	
	Straight and angled dimension "B"		Straight and adjustable dimension "B"		Straight and adjustable dimension "B"	
	mm	in	mm	in	mm	in
-02	6,4	0.25	–	–	–	–
-04	9,7	0.38	9,1	0.36	10,9	0.43
-05	–	–	9,1	0.36	10,9	0.43
-06	9,7	0.38	9,1	0.39	11,9	0.47
-08	12,7	0.50	10,9	0.43	14,0	0.55
-10	–	–	12,7	0.50	16,0	0.63
-12	15,7	0.62	15,0	0.59	18,5	0.73
-14	–	–	15,0	0.59	–	–
-16	17,5	0.69	15,0	0.59	18,5	0.73
-20	17,5	0.69	15,0	0.59	18,5	0.73
-24	17,5	0.69	15,0	0.59	18,5	0.73
-32	19,1	0.75	15,0	0.59	–	–

Allowable bulkhead thickness

For ORS

Dash size	Hole diameter	ORS bulkhead thickness			
		Min		Max	
		mm	in	mm	in
-04	0.575 +.015/-.000	5,1	0.20	12,7	0.50
-06	0.700 +.015/-.000	5,1	0.20	15,0	0.59
-08	0.825 +.015/-.000	5,6	0.22	15,0	0.59
-10	1.015 +.015/-.000	5,8	0.23	15,0	0.59
-12	1.200 +.015/-.000	6,4	0.25	15,0	0.59
-16	1.450 +.015/-.000	6,4	0.25	15,2	0.60
-20	1.715 +.015/-.000	6,4	0.25	15,2	0.60
-24	2.030 +.015/-.000	6,4	0.25	15,2	0.60

For SAE 37° flare

Dash size	Hole diameter	37° bulkhead thickness straights				37° bulkhead thickness shapes			
		Min		Max		Min		Max	
		mm	in	mm	in	mm	in	mm	in
-03	0.391 +.016/-.000	1,3	0.05	10,4	0.41	3,3	0.13	6,4	0.25
-04	0.453 +.016/-.000	1,3	0.05	10,4	0.41	3,3	0.13	7,1	0.28
-05	0.516 +.016/-.000	1,3	0.05	10,4	0.41	3,3	0.13	7,1	0.28
-06	0.578 +.016/-.000	1,3	0.05	11,2	0.44	3,3	0.13	7,6	0.30
-08	0.766 +.016/-.000	1,3	0.05	11,2	0.44	4,1	0.16	8,6	0.34
-10	0.891 +.016/-.000	1,3	0.05	11,9	0.47	4,1	0.16	9,1	0.36
-12	1.076 +.016/-.000	1,3	0.05	11,9	0.47	4,1	0.16	9,7	0.38
-16	1.328 +.016/-.000	1,3	0.05	11,9	0.47	4,1	0.16	9,7	0.38
-20	1.656 +.031/-.000	1,3	0.05	11,9	0.47	4,1	0.16	9,7	0.38
-24	1.906 +.031/-.000	1,3	0.05	11,9	0.47	4,1	0.16	9,7	0.38

Metric thread dimensions

Conversion adapters

Sealing is achieved by means of an O-Ring, retaining washer and a properly machined port. The O-Ring is "captured" by the I.D. of the retaining washer. The port may be of the spot faced or a flat machined surface as long as the D6 dimension is met. Assembly instructions for adjustable type adapters are presented on page A-60-61.

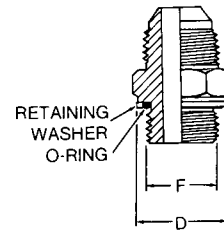
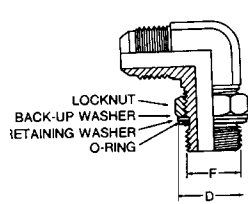

DIN 3852 large spot face

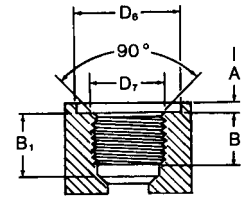

Equivalent to DIN 3852 form x

Thread size	M 10 x 1	M 12 x 1.5	M 14 x 1.5	M 16 x 1.5	M 18 x 1.5	M 20 x 1.5	M 22 x 1.5	M 26 x 1.5	M 27 x 2	M 33 x 2	M 42 x 2	M 48 x 2
F Thread Dia.	10.0	12.0	14.0	16.0	18.0	20.0	22.0	26.0	27.0	33.0	42.0	48.0
A max	1.0	1.5	1.5	1.5	2.0	2.0	2.5	2.5	2.5	2.5	2.5	2.5
B min (full thread)	12.0	12.0	12.0	12.0	12.0	14.0	14.0	16.0	16.0	18.0	20.0	22.0
B1 min	13.5	18.5	18.5	18.5	18.5	20.5	20.5	22.5	24.0	26.0	28.0	30.0
D max	15.7	18.7	19.7	23.2	26.2	28.2	30.2	35.2	36.2	43.2	52.7	58.7
D6 min	16.2	19.2	20.2	23.7	26.9	28.9	30.7	35.7	36.7	44.4	53.4	59.9
D7 max	10.2	12.2	14.2	16.2	18.2	20.2	22.2	26.2	27.2	33.3	42.3	48.3

BSPP (parallel) threads

Sealing is achieved by means of an O-Ring, retaining washer and a properly machined port.

The O-Ring is "captured" by the I.D. of the retaining washer. The compression is controlled by the thickness of the retaining washer.

The port may be of the spot faced or a flat machined surface as long as the D6 dimension is met.

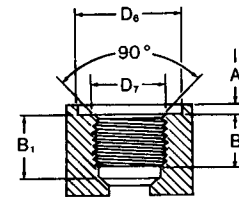
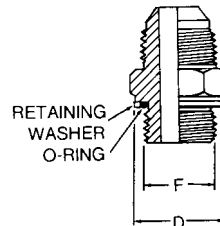
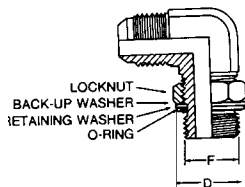

Thread size	G 1/8"-28		G 1/4"-19		G 3/8"-19		G 1/2"-14		G 3/4"-14		G 1"-11		G 1 1/4"-11		G 1 1/2"-11	
	mm	in	mm	in	mm	in	mm	in	mm	in	mm	in	mm	in	mm	in
F Thread Dia.	9,7	0.38	13,2	0.50	16,7	0.66	20,9	0.83	26,4	1.04	33,3	1.31	41,9	1.65	47,8	1.88
A max	1,0	0.04	2,0	0.08	2,05	0.10	2,5	0.10	2,5	0.10	2,5	0.10	2,5	0.10	2,5	0.10
B1 min (full thread)	8,0	0.31	12,0	0.47	12,0	0.47	14,0	0.63	16,0	0.63	18,0	0.71	20,0	0.79	22,0	0.87
B1 min	13,0	0.51	18,5	0.73	18,5	0.73	22,0	0.94	24,0	0.94	27,0	1.06	29,0	1.14	31,0	1.22
D max	15,7	0.62	19,7	0.78	24,0	0.94	28,7	1.38	35,2	1.38	43,2	1.70	52,7	2.07	58,7	2.31
D6 min	16,2	0.64	20,2	0.81	24,9	0.98	29,4	1.43	36,4	1.43	44,4	1.75	53,4	2.10	59,9	2.36
D7 max	10,0	0.39	13,4	0.53	16,9	0.67	21,2	1.05	26,7	1.05	33,6	1.32	42,3	1.67	48,2	1.90

BSPT (tapered) threads port sealing

Sealing is achieved by means of metal to metal deformation of the adapter and port threads.

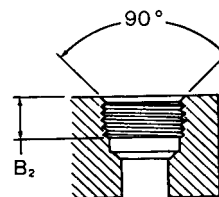

Thread size 11	R 1/8"-28		R 1/4"-19		R 3/8"-19		R 1/2"-14		R 3/4"-14		R 1"-11		R 1 1/4"-11		R 1 1/2"-11	
	mm	in	mm	in	mm	in	mm	in	mm	in	mm	in	mm	in	mm	in
B2 min (full thread)	5,5	0.22	8,5	0.33	8,5	0.33	10,5	0.41	13,0	0.51	14,5	0.57	17,0	0.67	17,0	0.67

Assembly instructions

Assembly torque

A

Recommended parallel connection assembly torque

Eaton recommends that a torque wrench be used to assure proper fitting assembly of these connections.

Straight thread O-Ring boss low pressure with 37° (SAEJ514)

Dash size	Thread size (inches)	Jam nut or straight fitting torque lb.-ft.	Jam nut or straight fitting torque newton meters
-03	3/8-24	8-9	12-13
-04	7/16-20	13-15	18-20
-05	1/2-20	14-15	19-21
-06	9/16-18	23-24	32-33
-08	3/4-16	40-43	55-57
-10	7/8-14	43-48	59-64
-12	1 1/16-12	68-75	93-101
-14	1 3/16-12	83-90	113-122
-16	1 5/16-12	112-123	152-166
-20	1 5/8-12	146-161	198-218
-24	1 7/8-12	154-170	209-230
-32	2 1/2-12	218-240	296-325

The values listed are for steel connections. Contact Eaton for torque values for other materials.

Straight thread O-Ring boss high pressure with ORS (J1453)

Dash size	Thread size (inches)	Jam nut or straight fitting torque lb.-ft.	Jam nut or straight fitting torque newton meters
-03	3/8-24	8-10	11-13
-04	7/16-20	14-16	20-22
-05	1/2-20	18-20	24-27
-06	9/16-18	24-26	33-35
-08	3/4-16	50-60	68-78
-10	7/8-14	72-80	98-110
-12	1 1/16-12	125-135	170-183
-14	1 3/16-12	160-180	215-245
-16	1 5/16-12	200-220	270-300
-20	1 5/8-12	210-280	285-380
-24	1 7/8-12	270-360	370-490

ORS

Dash size	Thread size (inches)	Swivel nut torque lb.-ft.	Swivel nut torque newton meters
-04	9/16-18	10-12	14-16
-06	11/16-16	18-20	24-27
-08	13/16-16	32-35	43-47
-10	1-14	46-50	62-68
-12	1 3/16-12	65-70	88-95
-16	1 7/16-12	92-100	125-136
-20	1 11/16-12	125-140	170-190
-24	2-12	150-165	204-224

SAE 37° (JIC)

Dash size	Thread size (inches)	Swivel nut torque lb.-ft.	Swivel nut torque newton meters	Hex turns*
-04	7/16-20	11-12	15-16	1 1/2 - 1 3/4
-05	1/2-20	15-16	20-22	1 1/2 - 1 3/4
-06	9/16-18	18-20	24-28	1 - 1 1/2
-08	3/4-16	38-42	52-58	1 1/4 - 1 3/4
-10	7/8-14	57-62	77-85	1 1/4 - 1 3/4
-12	1 1/16-12	79-87	108-119	1 - 1 1/2
-16	1 5/16-12	108-113	148-154	3/4 - 1
-20	1 5/8-12	127-133	173-182	1/2 - 3/4
-24	1 7/8-12	158-167	216-227	3/4
-32	2 1/2-12	245-258	334-352	1

* Additional hex turns past hand tight

Metric

Thread size	Straight adapter or locknut torque	
	lb.-ft.	Newton meters
M10 x 1	13-15	18-20
M12 x 1.5	15-19	20-25
M14 x 1.5	19-23	25-30
M16 x 1.5	33-40	45-55
M18 x 1.5	37-44	50-60
M20 x 1.5	52-66	70-90
M22 x 1.5	55-70	75-95
M26 x 1.5	81-96	110-130
M27 x 2	96-111	130-150
M33 x 2	162-184	220-250
M42 x 2	170-192	230-260
M48 x 2	258-347	350-470

BSPP

Nominal thread size	Straight adapter or locknut torque	
	lb.-ft.	Newton meters
inches**		
G 1/8-28	13-15	18-20
G 1/4-19	19-23	25-30
G 3/8-19	33-40	45-55
G 1/2-14	55-70	75-95
G 3/4-14	103-118	140-160
G 1-11	162-184	220-250
G 1 1/4-11	170-192	230-260
G 1 1/2-11	258-347	350-470

**"G" denotes parallel threads, other than ISO 6149. (Port connection only)

Assembly Instruction for ORS tube fittings

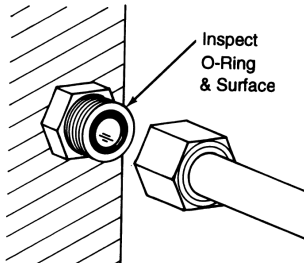

1. Inspect sealing surfaces and O-Ring groove for damage or foreign material. Check the O-Ring to insure that it is properly seated in the O-Ring groove.
2. Lubricate threads with heavy lubricant such as part number 222070 Lube.

3. Align the ORS tube fitting to the flat sealing connections and tighten the nut by hand. The nut should tighten easily by hand if properly aligned.

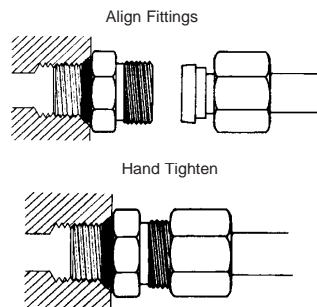

4. Complete the assembly by wrench tightening the nut to the recommended torque value on page A-60.

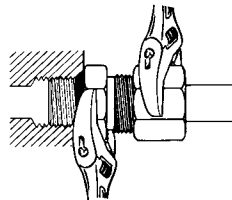

Assembly Instructions for Standard SAE 37° Flare type tube fitting

Use SAE J524 or SAE J525 tubing for best bending and flaring results.

1. Cut the tubing with a tube cutter. If a fine tooth hacksaw is used, make sure cut-off is square; remove burrs with deburring tool, emery paper or fine file. Clean all dirt and grit from the I.D. and O.D. of the tube.
2. Place the nut and then the sleeve onto tube. The threaded end of nut and flared end of sleeve must face the end of tube.

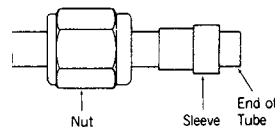

3. Flare the tube end with a flaring tool to provide a 37° flare. Check the flare for correct diameter, excessive thin out and burrs or cracks.
4. Lubricate all mating surfaces of nut, ferrule and body with a heavy lubricant such as part number 222070 Lube.
5. Assemble the nut and sleeve to body. Turn the nut hand tight then wrench tighten for a leakproof joint. See page A-60, torque values, for assembly using a torque wrench.

The Eaton standard 37° flare fitting is easy to disassemble and may be reassembled repeatedly.

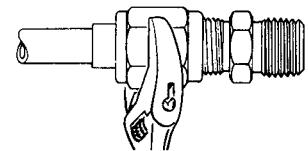

Assembly Instructions for Pipe threads

1. Assemble connection hand tight.
2. Mark male and female.
3. Rotate male; 1 1/2 turns if using thread sealant. 2 turns if not using thread sealant.

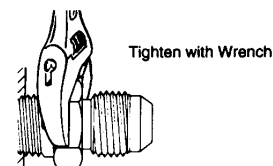
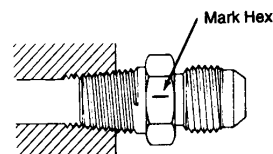
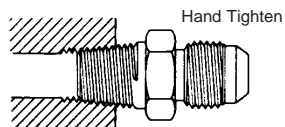

Tubing Selection

Tubing type and Tubing size

A

To select tubing for a particular installation, two factors must be determined:

1. **Tubing Type** - material and construction and
2. **Tubing Size** - inside diameter (I.D.) and wall thickness.

Information listed below will aid in your tubing selection.

Tubing Types

Commercial tubing is available in a wide variety of materials, types of construction and quality. Each is best suited for certain specific applications.

Steel Tubing - Seamless SAE 1010 fully annealed and SAE welded types suitable for bending and flaring. This is the only tubing material approved without restrictions by SAE standards.

Stainless Steel Tubing - Both seamless *18-8 fully annealed and welded types suitable for bending and flaring. Stainless steel tubing is recommended for use with very high pressures and here large diameter tubing is required. It is also suited for many applications where corrosion is a problem. *(302, 303 and/or 304)

Aluminum Tubing - Seamless annealed is approved by SAE for low pressure applications.

Copper Tubing - Seamless fully annealed coils and fully annealed or quarterhard straight lengths can be used for systems that do not use petroleum based fluids (copper acts as an oil-oxidation catalyst, causing sludge). Copper also tends to work harden when flared or bent and has poor resistance to vibration. Therefore, the use of copper tubing is limited to low-pressure stationary applications and air circuits.

Special Alloy Tubing - May be required for specific corrosion problems. Information on these applications can be obtained from your tubing supplier or from tubing manufacturers.

Tubing Size

The two variables in tubing size are the inside diameter (I.D.) and the wall thickness. Each of these is dependent upon a number of factors.

Inside Diameter - The tubing I.D. will determine the flow and velocity of the fluid in the system. Flow is the volume of fluid that is to be moved through the line to perform a given job within a specified time. Flow rate is expressed in gallons per minute (gpm). Velocity is the rate of speed at which the fluid passes through the line. It is expressed in feet per second (fps). With a given flow rate, the velocity will increase as the inside diameter of the tubing decreases. To determine the appropriate tubing I.D. for specific flow rate and velocity, refer to the Velocity vs. Flow chart on page A-64.

Wall Thickness - The required wall thickness of the tubing depends upon operating pressure, safety factor, temperatures, and tubing material. Operating Pressure is the pressure of the fluid in the system. It is expressed in pounds per square inch (psi). Safety Factor is a multiplier applied to the wall thickness that compensates for additional mechanical strains and hydraulic shocks to which the tubing may be subjected during operation. To determine the appropriate wall thickness, refer to the data on pages A-43-44.

Pressure Drop

Total pressure supplied to a line must equal usable pressure (or output) plus the pressure that is lost through fluid transmission, which is referred to as pressure drop. These pressure drops cause loss of energy and should be kept to a minimum. Elements which cause pressure drop in the transmission of fluids include sudden enlargements or contractions, bends, fittings and valves.

Mathematical analysis of pressure drop, although possible, is not precise because of the interrelationship of factors such as fluid velocity, density, flow area and friction coefficients. Therefore, to obtain optimum efficiency, the system (or the questionable portions of the system) should be mocked-up to obtain empirical pressure drop data.

WARNING

Refer to safety information regarding tubing selection on pages A-2.

To determine tube size

Following is a typical problem that illustrates, step by step, the procedure for determining tube size.

Select 1010 steel tubing with the appropriate I.D. and wall thickness for the following conditions:

- Flow..... 5 gpm
- Velocity.....not to exceed 10 fps
- Pressure 2000 psi
- Safety Factor4:1

Solution:

1. Using the Flow/Velocity chart on Page A-64, follow the horizontal flow line (5 gpm) until it intersects the vertical velocity line (10fps). From this point, follow the diagonal line upward to get the required tube I.D. (.444). If the horizontal flow line and the vertical velocity line intersect between two diagonal lines, normally the larger inside diameter would be selected since it would mean less velocity.
2. Refer to the chart of Standard Size Hydraulic Tubing, at right. Note that .444 I.D. tubing is not listed. If you want to use standard tubing, select one with a larger I.D. Do not select a smaller size since this would increase the velocity to over the 10 fps limit. Therefore, by going to the next largest size, you would select the 5/8" O.D. tubing having an I.D. of .459 and a wall thickness of .083.
3. To determine whether this tubing will meet the pressure and safety factor requirements, refer to the Recommended Wall Thickness data on pages A-43-44. For 5/8" O.D. tubing at 2000 psi, the chart for 1010 steel indicates that the minimum wall thickness with a safety factor of 4:1 is .04545. Since you have selected a tubing with a .083 wall, this would easily fulfill the requirements. However, for savings on weight and cost, you can select another tubing with a thinner wall that will still meet the performance requirements. Therefore, refer again to the chart on standard size tubing and select a tubing with a wall thickness closer to the minimum requirements. This would be the 5/8" O.D. tubing with a .527 I.D. and a .049 wall. This tubing will handle the pressure requirements of 2000 psi with a safety factor of 4:1, and also provides the required flow while keeping the velocity within the 10 fps limitation.

Standard size hydraulic tubing table

Tube O.D.	Tube I.D.	Wall	Tube O.D.	Tube I.D.	Wall		
1/8"	.055	.035	3/4"	.584	.083		
	.061	.032		.606	.072		
	.065	.030		.620	.065		
	.069	.028		.634	.058		
3/16"	.117	.035	7/8"	.652	.049		
	.123	.032		.680	.035		
	.127	.030		.657	.109		
	.120	.065		.685	.095		
1/4"	.134	.058	1"	.709	.083		
	.152	.049		.731	.072		
	.166	.042		.745	.065		
	.180	.035		.759	.058		
	.190	.030		.777	.049		
	5/16"	.182		.065	1-1/4"	.760	.120
		.196		.058		.782	.109
		.214		.049		.810	.095
.228		.042	.834	.083			
3/8"	.242	.035	1-1/2"	.856	.072		
	.248	.032		.870	.065		
	.245	.065		.884	.058		
	.259	.058		.902	.049		
	.277	.049		2"	.982	.134	
	.291	.042			1.010	.120	
	.305	.035			1.032	.109	
	.311	.032			1.060	.095	
1/2"	.310	.095	2-1/2"	1.084	.083		
	.334	.083		1.106	.072		
	.358	.072		1.120	.065		
	.370	.065		1.134	.058		
	.384	.058		1.152	.049		
	.402	.049		3"	1.232	.134	
	.416	.042			1.260	.120	
	.430	.035			1.282	.109	
.436	.032	1.310	.095				
5/8"	.435	.095	3-1/2"	1.334	.083		
	.459	.083		1.356	.072		
	.481	.072		1.370	.065		
	.495	.065		4"	1.732	.134	
	.509	.058			1.760	.120	
	.527	.049			1.782	.109	
	.541	.042			1.810	.095	
	3/4"	.555		.035	4-1/2"	1.834	.083
.532		.109	1.856	.072			
.560		.095	1.870	.065			

WARNING

Refer to safety information regarding tubing selection on pages A-2.

Tubing Selection

Flow / Velocity chart



WARNING
Refer to safety information regarding tubing selection on pages A-2.

A

Flow / Velocity chart

To find the required tube I.D. flow—20 gpm - Velocity—9 fps

Follow horizontal flow line (20 gpm) until it intersects vertical velocity line (9 fps). From this point follow diagonal line to get required Tube I.D. —(.944).

To find permissible flow velocity—15 fps - Tube I.D.—.495

Follow vertical velocity line (15 fps) until it intersects diagonal line representing .495 tube I.D. Then project this point horizontally to get the permissible flow —(9 gpm).

To find velocity of fluid in system flow—6 gpm - Tube I.D.—.694

Follow horizontal flow line (6 gpm) until it intersects diagonal line representing .694 tube I.D. Then project this point vertically downward to get the velocity of fluid —(5 fps).

Flow/Velocity Chart

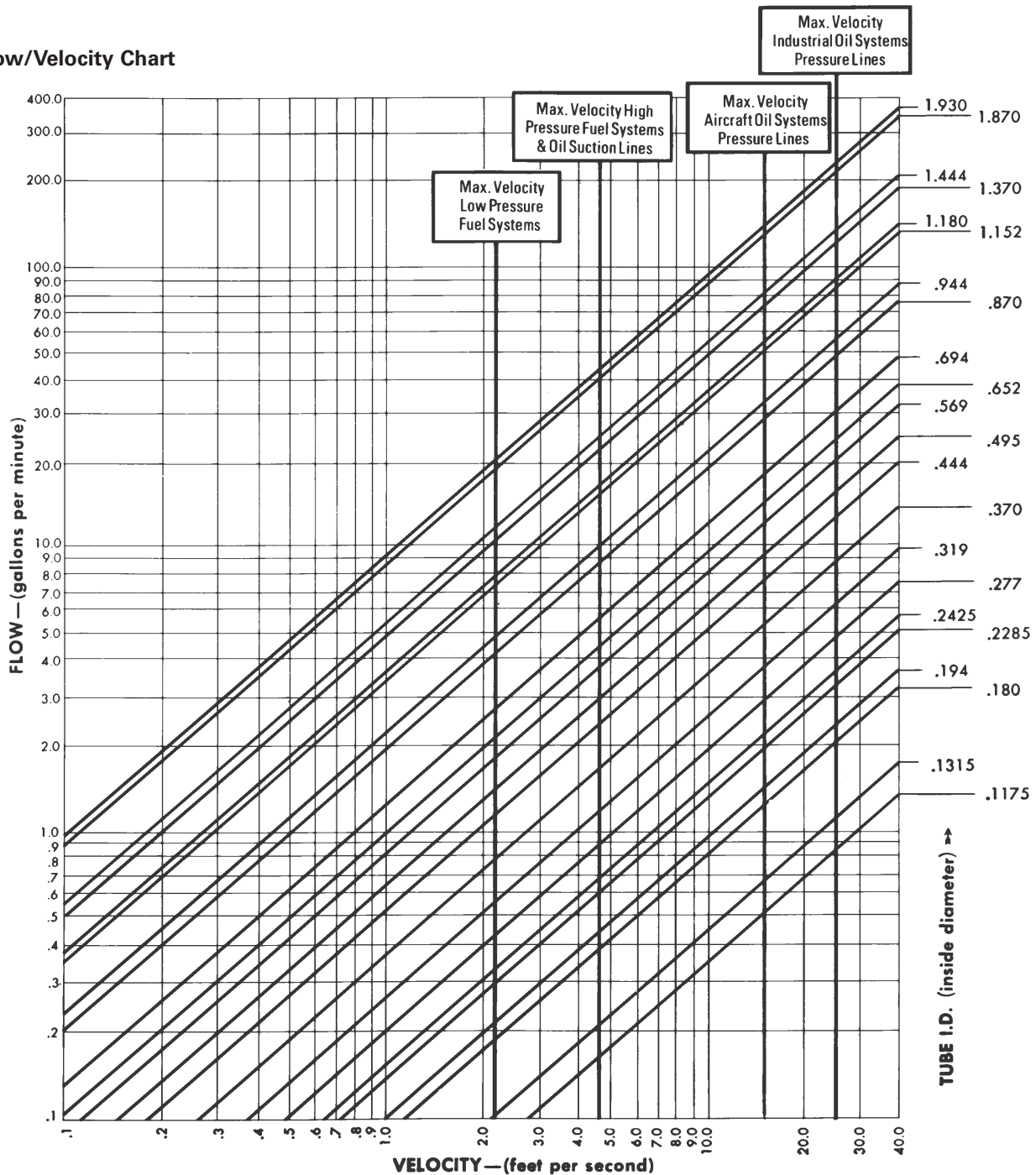

WARNING

Refer to safety information regarding tubing selection on pages A-2.

With the following Recommended Wall Thickness tables the tubing wall can be selected that is best suited for a particular application. The data given in these tables are raw figures based on the equation – $t = \frac{Dp}{2S}(FS)$

- t** – wall thickness (inches)
- D** – O.D. of tube (inches)
- p** – pressure (psi)
- FS** – Safety Factor
- S** – tensile strength of tubing material

Therefore, many of the wall thicknesses given in these tables are not found on standard tubing, but serve to establish the minimum wall required.

Safety factor – The standard safety factors indicate three grades of severity of service:

- 4:1** – mechanical and hydraulic shocks not excessive
- 6:1** – considerable mechanical strain and hydraulic shock
- 8:1** – hazardous applications with severe service conditions

The wall thickness shown in these tables are based on ultimate strength of material and a safety factor of **4:1**.

To obtain the recommended wall for a specific pressure based on a safety factor of **6:1**, multiply the wall thickness indicated in the table by 1.5.

For a safety factor of **8:1**, multiply by 2.

Temperature – The wall thickness found by using these tables can be corrected for temperature by multiplying the wall thickness by the appropriate correction factor given in the chart below. The table is based on strength reduction due to increased temperature.

Temperature	1010 Steel	Stainless Steel	Copper	Aluminum
+100F	1.00	1.00	1.00	1.00
+200F	1.00	1.00	1.08	1.00
+300F	1.00	1.00	1.22	1.08
+400F	1.00	1.00	2.30	1.41
+500F	1.00	1.00	–	2.10
+600F	1.00	1.00	–	–
+700F	1.00	1.00	–	–
+800F	1.08	1.07	–	–
+900F	1.32	1.13	–	–
+1000F	1.66	1.22	–	–

Recommended wall thickness tables

The wall thickness shown in these tables are based on ultimate strength of material and a safety factor of **4:1**.

1010 STEEL Based on 55,000#/in.2 Strength (F S=4)

Hose O.D.	Working Pressure (psi)				
	1,000	2,000	3,000	4,000	5,000
1/8	.00455	.00909	.01364	.01818	.02273
3/16	.00682	.01364	.02045	.02727	.03409
1/4	.00909	.01818	.02727	.03636	.04545
5/16	.01136	.02273	.03409	.04545	.05682
3/8	.01364	.02727	.04091	.05455	.06818
1/2	.01818	.03636	.05455	.07273	.09091
5/8	.02273	.04545	.06818	.09091	.11364
3/4	.02727	.05455	.08182	.10909	.13636
7/8	.03182	.06364	.09545	.12727	.15909
1	.03636	.07273	.10909	.14545	.18182
1-1/4	.04545	.09091	.13636	.18182	.22727
1-1/2	.05455	.10909	.16364	.21818	.27273
2	.07273	.14545	.21818	.29091	.36364

4130 STEEL Based on 90,000#/in.2 Strength (F S=4)

Hose O.D.	Working Pressure (psi)				
	1,000	2,000	3,000	4,000	5,000
1/8	.00278	.00556	.00833	.01111	.01389
3/16	.00417	.00833	.01250	.01667	.02083
1/4	.00556	.01110	.01667	.02222	.02778
5/16	.00694	.01389	.02083	.02778	.03472
3/8	.00833	.01667	.02499	.03333	.04167
1/2	.01111	.02222	.03333	.04444	.05556
5/8	.01389	.27778	.04167	.05556	.06944
3/4	.01667	.03333	.04999	.06667	.08333
7/8	.01944	.03889	.05833	.07778	.09722
1	.02222	.04444	.06667	.08889	.11111
1-1/4	.02778	.05556	.08333	.11111	.13889
1-1/2	.03333	.06667	.09999	.13333	.16667
2	.04444	.08889	.13333	.17778	.22222

1020 STEEL Based on 65,000#/in.2 Strength (F S=4)

Tube O.D.	Working Pressure (psi)				
	1,000	2,000	3,000	4,000	5,000
1/8	.00385	.00790	.01154	.01538	.01923
3/16	.00577	.01154	.01731	.02308	.02885
1/4	.00769	.01538	.02308	.03077	.03846
5/16	.00962	.01923	.02885	.03846	.04808
3/8	.01154	.02308	.03462	.04615	.05769
1/2	.01538	.03077	.04615	.06154	.07692
5/8	.01923	.03846	.05769	.07692	.09615
3/4	.02308	.04615	.06923	.09231	.11538
7/8	.02692	.05385	.08077	.10769	.13462
1	.03077	.06154	.09231	.12308	.15385
1-1/4	.03846	.07692	.11538	.15385	.19231
1-1/2	.04615	.09231	.13846	.18462	.23077
2	.06154	.12308	.18462	.24615	.30769

Tubing Selection

Recommended wall thickness



WARNING

Refer to safety information regarding tubing selection on pages A-2.

A

TUBE O.D.	STAINLESS STEEL (304) ANNEALED BASED ON 75,000#/IN ² STRENGTH (F.S. -4)					STAINLESS STEEL (304) ANNEALED BASED ON 105,000#/IN ² STRENGTH (F.S. -4)				
	working pressure (psi)					working pressure (psi)				
	1,000	2,000	3,000	4,000	5,000	1,000	2,000	3,000	4,000	5,000
1/8	.00333	.00666	.00999	.01333	.01666	.00238	.00476	.00714	.00952	.01190
3/16	.00499	.00999	.01498	.01999	.02499	.00357	.00714	.01071	.01429	.01786
1/4	.00666	.01332	.01998	.02667	.03333	.00476	.00952	.01429	.01905	.02381
5/16	.00833	.01665	.02497	.03333	.04165	.00595	.01190	.01786	.02381	.02976
3/8	.0099	.01998	.02997	.03999	.04998	.00714	.01429	.02143	.02857	.03571
1/2	.01332	.02664	.03996	.05333	.06664	.00957	.01904	.02857	.03810	.04762
5/8	.01665	.03333	.04995	.06666	.08330	.01190	.02381	.03571	.04762	.05952
3/4	.01998	.03996	.05994	.07999	.09996	.01429	.02857	.04286	.05714	.07143
7/8	.02331	.04662	.06996	.09333	.11662	.01667	.03333	.05000	.06666	.08333
1	.02664	.05328	.07992	.10666	.13328	.01904	.03810	.05714	.07619	.09524
1-1/4	.03333	.06666	.09999	.13333	.16666	.02381	.04762	.07143	.09524	.11905
1-1/2	.03996	.07992	.11988	.15999	.19992	.02857	.05714	.08371	.11429	.14286
2	.05328	.10656	.15984	.21333	.26666	.03810	.07619	.11428	.15238	.19048

TUBE O.D.	ANNEALED COPPER BASED ON 30,000#/IN ² STRENGTH (F.S. -4)					COPPER (UNS C12200 LIGHT DRAWN) BASED ON 40,000#/IN ² STRENGTH (F.S. -4)				
	working pressure (psi)					working pressure (psi)				
	1,000	2,000	3,000	4,000	5,000	1,000	2,000	3,000	4,000	5,000
1/8	.00833	.01667	.02500	.03333	.04167	.00625	.01250	.01875	.02500	.03125
3/16	.01250	.02499	.03750	.04999	.06250	.00938	.01875	.02812	.03750	.04688
1/4	.01667	.03333	.05000	.06666	.08333	.01250	.02500	.03750	.05000	.06250
5/16	.02083	.04167	.06250	.08333	.10417	.01562	.03125	.04688	.06250	.07812
3/8	.02499	.04999	.07500	.09999	.12499	.01875	.03750	.05625	.07500	.09375
1/2	.03333	.06667	.10000	.13333	.16667	.02500	.05000	.07500	.10000	.12500
5/8	.04167	.08333	.12500	.16666	.20883	.03125	.06250	.09375	.12500	.15625
3/4	.04999	.09999	.15000	.19999	.24999	.03750	.07500	.11250	.15000	.18750
7/8	.05833	.11667	.17500	.23333	.29166	.04375	.08750	.13125	.17500	.21875
1	.06667	.13333	.20000	.26666	.33333	.05000	.10000	.15000	.20000	.25000
1-1/4	.08333	.16667	.25000	.33333	.41667	.06250	.12500	.18750	.25000	.31250
1-1/2	.09999	.19999	.30000	.39999	.49999	.07500	.15000	.22500	.30000	.37500
2	.13333	.26667	.40000	.53333	.66667	.10000	.20000	.30000	.40000	.50000

TUBE O.D.	ALUMINUM 3003 (H-14) BASED ON 20,000#/IN ² STRENGTH (F.S. -4)					ALUMINUM 5052 (H-32) BASED ON 31,000#/IN ² STRENGTH (F.S. -4)				
	working pressure (psi)					working pressure (psi)				
	1,000	2,000	3,000	4,000	5,000	1,000	2,000	3,000	4,000	5,000
1/8	.01250	.02500	.3750	.05000		.00806	.01613	.02419	.03226	.04032
3/16	.01875	.03750	.05650	.07500		.01210	.02419	.03629	.04839	.06048
1/4	.02500	.05000	.07500	.10000		.01613	.03226	.04839	.06452	.08065
5/16	.03125	.06250	.09375	.12500		.02016	.04032	.06048	.08065	.10081
3/8	.03750	.07500	.11250	.15000		.02419	.04839	.07258	.09677	.12097
1/2	.05000	.10000	.15000	.20000		.03227	.06452	.09677	.12903	.16129
5/8	.06250	.12500	.18750	.25000		.04032	.08065	.12097	.16129	.20161
3/4	.07500	.15000	.22500	.30000		.04839	.09677	.14516	.19355	.24194
7/8	.08750	.17500	.26250	.35000		.05645	.11290	.16935	.22581	.28226
1	.10000	.20000	.30000	.40000		.06452	.12903	.19355	.25806	.32258
1-1/4	.12500	.25000	.37500	.50000		.08065	.16129	.24194	.32258	.40323
1-1/2	.15000	.30000	.45000	.60000		.09677	.19355	.29032	.38710	.48387
2	.20000	.40000	.60000	.80000		.12903	.25806	.38710	.51613	.64516

TUBE O.D.	CUPRO-NICKEL 30% BASED ON 52,000#/IN ² STRENGTH (F.S. -4)				
	working pressure (psi)				
	1,000	2,000	3,000	4,000	5,000
1/8	.00481	.00962	.01442	.01923	.02404
3/16	.00721	.01442	.02163	.02885	.03606
1/4	.00962	.01923	.02885	.03846	.04808
5/16	.01202	.02404	.03606	.04808	.06010
3/8	.01442	.02885	.04327	.05769	.07212
1/2	.01923	.03846	.05769	.07692	.09615
5/8	.02404	.04808	.07212	.09615	.12019
3/4	.02885	.05769	.08654	.11538	.14423
7/8	.03365	.06731	.10096	.13462	.16827
1	.03846	.07692	.11538	.15385	.19231
1-1/4	.04808	.09615	.14423	.19231	.24038
1-1/2	.05769	.11538	.17308	.23077	.28846
2	.07692	.15385	.23077	.30769	.38462

SHADED AREAS

Tubing wall thickness listed in the shaded areas are generally either too light or too heavy for practical applications, and are listed only to provide data for accurate computation.

⚠ WARNING

Refer to safety information regarding tubing selection on pages A-2.

Tubing Selection

Recommended wall thickness

These tables provide data on required wall thickness for various sizes and pressures, and when to use flared or flareless fittings.

Although heavier wall tubing can be ordered for higher operating pressures, only standard size hydraulic tubing is listed in these tables. High temperature effects are not considered in these tables.

A

1010 STEEL TUBING WALL THICKNESS

TUBE O.D.	4:1 SAFETY FACTOR					6:1 SAFETY FACTOR					8:1 SAFETY FACTOR				
	working pressure (psi)					working pressure (psi)					working pressure (psi)				
	1,000	2,000	3,000	4,000	5,000	1,000	2,000	3,000	4,000	5,000	1,000	2,000	3,000	4,000	5,000
1/8	.028	.028	.028	.028	.028	.028	.028	.028	.028	.035	.028	.028	.028	.035	-
3/16	.030	.030	.030	.030	.035	.030	.030	.030	-	-	.030	.030	-	-	-
1/4	.030	.030	.030	.042	.049	.030	.030	.042	.058	-	.030	.035	.058	-	-
5/16	.032	.032	.035	.049	.058	.032	.032	.058	.065	-	.032	.049	.065	-	-
3/8	.032	.032	.042	.058	-	.032	.042	.058	-	-	.032	.058	-	-	-
1/2	.032	.042	.058	.072	-	.032	.058	.083	-	-	.042	.072	-	-	-
5/8	.035	.049	.072	.095	-	.035	.072	-	-	-	.049	.095	-	-	-
3/4	.035	.058	.083	.109	-	.049	.083	-	-	-	.058	.109	-	-	-
7/8	.049	.065	.095	-	-	.049	.095	-	-	-	.065	-	-	-	-
1	.049	.072	.109	-	-	.058	.109	.072	-	-	.072	-	-	-	-
1-1/4	.049	.095	-	-	-	.072	-	-	-	-	.095	-	-	-	-
1-1/2	.065	.109	-	-	-	.083	-	-	-	-	.109	-	-	-	-
2	.072	-	-	-	-	.109	-	-	-	-	-	-	-	-	-

1020 STEEL TUBING WALL THICKNESS

TUBE O.D.	4:1 SAFETY FACTOR					6:1 SAFETY FACTOR					8:1 SAFETY FACTOR				
	working pressure (psi)					working pressure (psi)					working pressure (psi)				
	1,000	2,000	3,000	4,000	5,000	1,000	2,000	3,000	4,000	5,000	1,000	2,000	3,000	4,000	5,000
1/8	.028	.028	.028	.028	.028	.028	.028	.028	.028	.030	.028	.028	.028	.030	-
3/16	.030	.030	.030	.030	.030	.030	.030	.030	.035	-	.030	.030	.035	-	-
1/4	.030	.030	.030	.030	.042	.030	.030	.035	.049	.058	.030	.030	.049	-	-
5/16	.032	.032	.032	.042	.049	.032	.032	.042	.058	-	.032	.042	.058	-	-
3/8	.032	.032	.035	.049	.058	.032	.035	.058	.065	-	.032	.049	-	-	-
1/2	.032	.032	.049	.065	.083	.032	.049	.072	-	-	.032	.065	-	-	-
5/8	.035	.042	.058	.083	-	.035	.058	.095	-	-	.042	.083	-	-	-
3/4	.035	.049	.072	.095	-	.035	.072	.109	-	-	.049	.095	-	-	-
7/8	.049	.058	.083	-	-	.049	.083	-	-	-	.058	.109	-	-	-
1	.049	.065	.095	-	-	.049	.095	-	-	-	.065	-	-	-	-
1-1/4	.049	.083	.120	-	-	.058	.120	-	-	-	.083	-	-	-	-
1-1/2	.065	.095	-	-	-	.072	-	-	-	-	.095	-	-	-	-
2	.065	-	-	-	-	.095	-	-	-	-	.134	-	-	-	-

 Both SAE 37° SINGLE FLARE FLARE-TWIN or ERMETO® flareless recommended.

 ERMETO® flareless only.

Note: Refer Only Weatherhead Ermeto flareless fittings can be used with high pressure, heavy wall tubing which is impractical to flare.

Tubing Selection

Recommended wall thickness



WARNING
Refer to safety information regarding tubing selection on pages A-2.

A

These tables provide data on required wall thickness for various sizes and pressures, and when to use flared or flareless fittings.

Although heavier wall tubing can be ordered for higher operating pressures, only standard size hydraulic tubing is listed in these tables. High temperature effects are not considered in these tables.

STAINLESS STEEL (304) ANNEALED TUBING WALL THICKNESS

TUBE O.D.	4:1 SAFETY FACTOR					6:1 SAFETY FACTOR					8:1 SAFETY FACTOR				
	working pressure (psi)					working pressure (psi)					working pressure (psi)				
	1,000	2,000	3,000	4,000	5,000	1,000	2,000	3,000	4,000	5,000	1,000	2,000	3,000	4,000	5,000
1/8	.028	.028	.028	.028	.028	.028	.028	.028	.028	.035	.028	.028	.028	.028	.035
3/16	.030	.030	.030	.030	.030	.030	.030	.030	.030	.035	.030	.030	.030	.035	-
1/4	.030	.030	.030	.030	.035	.030	.030	.030	.042	.058	.030	.030	.035	.058	.065
5/16	.032	.032	.032	.035	.042	.032	.032	.035	.058	.065	.032	.032	.049	.065	-
3/8	.032	.032	.032	.042	.058	.032	.042	.065	.083	-	.032	.042	.058	-	-
1/2	.032	.032	.042	.058	.072	.032	.042	.065	.083	-	.032	.058	.083	-	-
5/8	.035	.035	.058	.072	.083	.035	.058	.083	.095	-	.035	.065	-	-	-
3/4	.035	.049	.065	.083	.109	.035	.065	.095	-	-	.049	.083	-	-	-
7/8	.049	.049	.072	.095	-	.049	.072	.109	-	-	.049	.095	-	-	-
1	.049	.058	.083	.109	-	.049	.083	.120	-	-	.058	.109	-	-	-
1-1/4	.049	.072	.109	-	-	.058	.109	-	-	-	.065	.134	-	-	-
1-1/2	.065	.083	.120	-	-	.065	.120	-	-	-	.083	-	-	-	-
2	.065	.109	-	-	-	.083	-	-	-	-	.109	-	-	-	-

STAINLESS STEEL (304) 1/8 HARD TUBING WALL THICKNESS

TUBE O.D.	4:1 SAFETY FACTOR					6:1 SAFETY FACTOR					8:1 SAFETY FACTOR				
	working pressure (psi)					working pressure (psi)					working pressure (psi)				
	1,000	2,000	3,000	4,000	5,000	1,000	2,000	3,000	4,000	5,000	1,000	2,000	3,000	4,000	5,000
1/8	.028	.028	.028	.028	.028	.028	.028	.028	.028	.028	.028	.028	.028	.028	.028
3/16	.030	.030	.030	.030	.030	.030	.030	.030	.030	.030	.030	.030	.030	.030	.035
1/4	.030	.030	.030	.030	.030	.030	.030	.030	.030	.035	.030	.030	.030	.042	.049
5/16	.032	.032	.032	.032	.032	.032	.032	.032	.035	.049	.032	.032	.035	.049	.058
3/8	.032	.032	.032	.032	.042	.032	.032	.032	.042	.058	.032	.032	.042	.058	-
1/2	.032	.032	.032	.042	.049	.032	.032	.042	.058	.072	.032	.042	.058	.083	-
5/8	.035	.035	.042	.049	.065	.035	.035	.058	.072	.095	.035	.049	.072	.095	-
3/4	.035	.035	.049	.058	.072	.035	.049	.065	.095	.109	.035	.058	.095	-	-
7/8	.049	.049	.058	.072	.083	.049	.058	.083	.109	-	.049	.065	.109	-	-
1	.049	.049	.058	.083	.095	.049	.058	.095	-	-	.049	.072	-	-	-
1-1/4	.049	.049	.072	.095	.120	.049	.072	.109	-	-	.049	.095	-	-	-
1-1/2	.065	.065	.095	-	-	.065	.095	-	-	-	.065	-	-	-	-
2	.065	.083	.120	-	-	.065	-	-	-	-	.083	-	-	-	-

Both SAE 37° SINGLE FLARE FLARE-TWIN or ERMETO® flareless recommended.

ERMETO® flareless only.

Note: Refer Only Weatherhead Ermeto flareless fittings can be used with high pressure, heavy wall tubing which is impractical to flare.

NOTE: Only Weatherhead Ermeto flareless fittings can be used with high pressure, heavy wall tubing which is impractical to flare.

Hydraulic hose

Braided hose – Premium

SAE100R1, EN857,
SAE100R17, EN853

H180	B-6
H145R	B-7
H190H	B-8

SAE100R16, EN857,
SAE100R2, EN853

H280	B-9
H290H	B-10
H245L	B-11

Spiral hose – Premium

SAE100R12, EN856, DIN856

H430	B-12
H430R	B-13
EC525	B-14

SAE100R13, EN856

H471	B-15
------------	-------------

SAE100R15, EN856

EC600	B-16
EC810	B-17
EC850	B-18

Braided hose – Other

H190	B-19
H290	B-20
H145	B-21
H545	B-22
H400	B-23
H421 WeatherJACK	B-24
EC230	B-24
H345	B-25

Spiral hose – Other

H464	B-26
EC910	B-26

Suction hose – Specialty

H039	B-27
H039H	B-28

Thermoplastic hose

3130	B-29
3740	B-30
37AL	B-31
3R80	B-32
3E80	B-32
30CT	B-33
3V10	B-34
3VE0	B-35
3130, 37AL and 30CT	B-36



Hydraulic hose

Braided hose – Premium

B

Braided hose – Premium

SAE 100R1, SAE 100R17, EN853, EN857

H180 Premium B-6



H145R Premium abrasion B-7



H190H Premium high temperature B-8

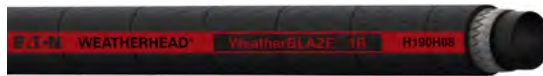

SAE 100R2, SAE 100R16, EN853, EN857

H280 Premium B-9

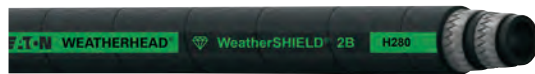

H290H Premium high temperature B-10



H245L Premium low temperature B-11

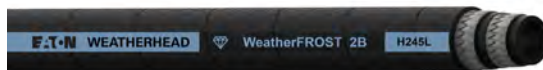

Spiral hose – premium

SAE 100R12, EN856, DIN856

H430 Premium **B-12**



H430R Premium abrasion **B-13**



EC525 Premium high temperature **B-14**



SAE 100R13, EN856

H471 Premium **B-15**



SAE 100R15, EN856

EC600 Premium **B-16**



EC810 Premium low temperature **B-17**

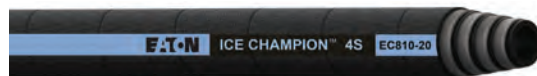

EC850 500 bar premium **B-18**



Hydraulic hose

Braided hose – Other, Spiral hose – Other, Suction hose

B

Braided hose – Other

H190 SAE 100R1, EN853 B-19



H290 SAE 100R2, EN853 B-20



H145 SAE 100R17 B-21



H545 Abrasion resistant B-22



H400 SAE 100R19 B-23

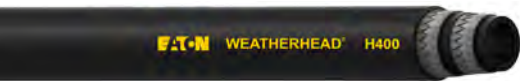

H421 Jack hose B-24



EC230 SAE 100R2 large bore B-24



H345 Pressure washer hose B-25

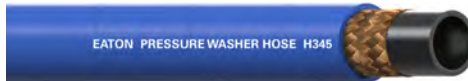

Spiral hose – Other

H464 EN856 Type 4SH B-26



EC910 Waterblast B-26



Suction hose

H039 SAE 100R4 B-27



H039H SAE 100R4 high temperature B-28



Thermoplastic hose

SAE 100R7

3130 Medium pressure **B-29**



3740 Medium pressure, non-conductive **B-30**



37AL Medium pressure, non-conductive **B-31**



SAE 100R8

3R80 High pressure **B-32**



3E80 High pressure, non-conductive **B-32**



SAE 100R18

30CT Constant pressure **B-33**



Extreme pressure

3V10 Very high pressure **B-34**



3VE0 Very high pressure, non-conductive **B-35**



3130, 37AL and 30CT Twin-line, tri-line, multi-line **B-36**

Hydraulic hose

Braided hose - Premium

B

H180

WeatherSHIELD

Exceeds SAE 100R1 Type S, EN857 1SC

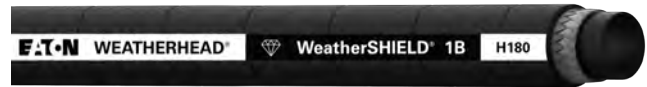

Diamond advantage

- Pressure
- Temperature
- Abrasion resistance

#	Hose I.D.			Hose O.D.		Maximum operating pressure		Minimum burst pressure		Minimum bend radius		Weight		Package length
	Part number	DN	mm	in	mm	in	bar	psi	bar	psi	mm	in	kg/m	
H18004 H18004-250R H18004-500R	6	6,4	0.25	12,9	0.51	255	3,700	1,020	14,800	50	1.97	0,14	0.09	50 250 500
H18006 H18006-250R H18006-500R	10	9,5	0.38	16,3	0.64	235	3,400	940	13,600	63	2.48	0,22	0.15	50 250 500
H18008 H18008-250R H18008-500R	12	12,7	0.50	19,9	0.78	221	3,200	883	12,800	90	3.54	0,29	0.20	50 250 500
H18010 H18010-250R	16	15,9	0.63	22,3	0.88	140	2,025	559	8,100	100	3.94	0,28	0.19	50 250
H18012 H18012-250R	19	19,0	0.75	26,0	1.02	138	2,000	552	8,000	120	4.72	0,37	0.25	50 250
H18016 H18016-250R	25	25,4	1.00	34,0	1.34	103	1,500	414	6,000	150	5.91	0,54	0.36	50 250
H18020	31	31,8	1.25	41,5	1.63	69	1,000	276	4,000	210	8.27	0,68	0.45	50
H18024	38	38,1	1.50	47,9	1.89	52	750	207	3,000	250	9.84	0,80	0.54	50
H18032	51	50,8	2.00	64,0	2.52	41	600	166	2,400	315	12.40	1,29	0.87	50

Construction

Tube: Nitrile

Reinforcement:

1 wire braid

Cover: WeatherSHIELD

Operating parameters

-46°C to +127°C
(-50°F to +260°F)

Application

- Low & medium pressure hydraulic systems, petroleum & water-based fluids
- Construction equipment, and agriculture equipment

For more information on agency listings, specific fluid applications and high temperature ratings see section A.

MSHA approved

Fitting reference	Page
Crimp	
"Z" series	H-29
Field Attachable	
"1R" series	I-2

H145R

RHINOHide II Abrasion resistant Constant pressure

Meets or exceeds: SAE 100R17



# Part number	Hose I.D.			Hose O.D.		Maximum operating pressure		Minimum burst pressure		Minimum bend radius		Weight		Package length
	DN	mm	in	mm	in	bar	psi	bar	psi	mm	in	kg/m	lbs/ft	ft
H145R04 H145R04-250R	6	6,4	0.25	12,7	0.50	210	3,050	840	12,200	50	1.97	0,22	0.15	50 250
H145R06 H145R06-250R H14506-500R	10	9,5	0.38	16,6	0.65	210	3,050	840	12,200	65	2.56	0,34	0.23	50 250 500
H145R08 H145R08-250R	12	12,7	0.50	20,8	0.82	210	3,050	840	12,200	90	3.54	0,48	0.32	50 250
H145R10	16	15,9	0.62	24,9	0.98	210	3,050	840	12,200	100	3.94	0,71	0.48	50
H145R12 H145R12-250R	19	19,0	0.75	28,4	1.12	210	3,050	840	12,200	120	4.72	0,89	0.60	50 250
H145R16 H145R16-250R	25	25,4	1.00	37,1	1.46	210	3,050	840	12,200	150	5.91	1,43	0.96	50 250

Construction

Tube: Nitrile

Reinforcement:

4-8 size: 1 wire braid;
10-16 size: 2 wire braids

Cover: UHMWPE

Operating parameters

-40°C to +100°C
(-40°F to +212°F)

Application

- 3,000 PSI constant working pressure hose with abrasion resistant cover
- Ideal for logging, construction, mining and other off highway applications

For more information on agency listings, specific fluid applications and high temperature ratings see section A.

Fitting reference	Page
Crimp	
"Z" series	H-29

Hydraulic hose

Braided hose - Premium

B

H190H WeatherBLAZE

Meets or exceeds: SAE 100R1 Type S, EN853 1SN



# Part number	Hose I.D.			Hose O.D.		Maximum operating pressure		Minimum burst pressure		Minimum bend radius		Weight		Package length
	DN	mm	in	mm	in	bar	psi	bar	psi	mm	in	kg/m	lbs/ft	feet
H190H04	6	6.4	0.25	13.5	0.53	225	3,250	900	13,000	100	4.00	0.25	0.17	50
H190H06	10	9.7	0.38	17.5	0.69	215	3,125	860	12,500	125	5.00	0.37	0.25	50
H190H08	12	12.7	0.50	20.6	0.81	175	2,550	700	10,200	180	7.00	0.45	0.30	50
H190H10	16	16.0	0.63	23.9	0.94	140	2,050	560	8,200	205	8.00	0.54	0.36	50
H190H12	19	19.1	0.75	27.7	1.09	125	1,800	500	7,200	240	9.50	0.68	0.46	50
H190H16	25	25.4	1.00	35.8	1.41	90	1,300	360	5,200	300	12.00	0.98	0.66	50
H190H20	31	31.8	1.25	43.9	1.73	65	950	260	3,800	420	16.50	1.26	0.85	50
H190H24	38	38.1	1.50	52.1	2.05	50	725	200	2,900	500	19.69	1.58	1.06	50
H190H32	51	50.8	2.00	65.5	2.58	40	580	160	2320	630	24.80	2.04	1.37	50

Construction

Tube: CPE

Reinforcement:
1 wire braid

Cover: CPE black

Operating parameters

-40°C to +150°C
(-40°F to +302°F)

Application

- Transfer of hydraulic fluid, water and air

MSHA accepted

For more information on agency listings, specific fluid applications and high temperature ratings see section A.

Fitting reference	Page
Crimp	
"Z" Series	H-29

H280

WeatherSHIELD

Meets or exceeds: SAE 100R16 Type S, EN857 2SC, ISO 1436

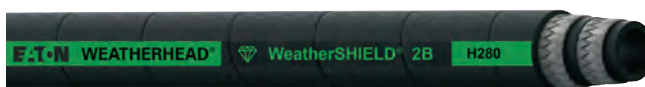

Diamond advantage

- Pressure
- Temperature
- Abrasion resistance

# Part number	Hose I.D.			Hose O.D.		Maximum operating pressure		Minimum burst pressure		Minimum bend radius		Weight		Package length
	DN	mm	in	mm	in	bar	psi	bar	psi	mm	in	kg/m	lbs/ft	feet
H28004 H28004-250R H28004-500R	6	6.4	0.25	14.1	0.56	448	6,500	1,792	26,000	50	1.96	0.33	0.22	50 250 500
H28006 H28006-250R H28006-500R	10	9.5	0.38	17.4	0.69	400	5,800	1,600	23,200	65	2.55	0.43	0.29	50 250 500
H28008 H28008-250R H28008-500R	12	12.7	0.50	20.8	0.82	345	5,000	1,380	20,000	90	3.54	0.58	0.39	50 250 500
H28010 H28010-250R	16	15.9	0.63	24.9	0.98	276	4,000	1,104	16,000	100	3.94	0.65	0.44	50 250
H28012 H28012-250R	19	19.0	0.75	28.4	1.12	241	3,500	964	14,000	120	4.72	0.79	0.53	50 250
H28016 H28016-250R	25	25.4	1.00	35.7	1.41	207	3,000	828	12,000	150	5.90	1.07	0.72	50 250
H28020 H28020-150	31	31.8	1.25	43.3	1.71	172	2,500	688	10,000	210	8.26	1.62	1.09	50 150
H28024 H28024-150	38	38.1	1.50	51.4	2.03	138	2,000	552	8,000	250	9.84	2.08	1.40	50 150
H28032	51	50.8	2.00	63.9	2.52	110	1,600	440	6,400	315	12.40	2.82	1.90	50

Construction

Tube: Nitrile

Reinforcement:
2 wire braids

Cover: WeatherSHIELD

Operating parameters

Petroleum based hydraulic fluids:

-46°C to +126°C
(-50°F to +260°F)

Water-based hydraulic fluids:

-46°C to +70°C
(-50°F to +158°F)

For water:

-0°C to +70°C
(-32°F to +158°F)

Application

- Hydraulic system service with petroleum and water-based fluids
- For general industrial service

For more information on agency listings, specific fluid applications and high temperature ratings see section A2

**MSHA approved,
ABS approved,
USCG approved**

Fitting reference

Crimp	Page
"Z" series	H-29
Field Attachable	
"2R" series	I-5

Hydraulic hose

Braided hose - Premium

B

H290H

WeatherBLAZE

Meets and exceeds: SAE100R2 Type AT, EN853 2SN



# Part number	Hose I.D.			Hose O.D.		Maximum operating pressure		Minimum burst pressure		Minimum bend radius		Weight		Package length
	DN	mm	in	mm	in	bar	psi	bar	psi	mm	in	kg/m	lbs/ft	feet
H290H04	6	6.4	0.25	15.2	0.60	400	5,800	1,600	23,200	102	4.02	0.4	0.27	50
H290H06 H290H06-250R	10	9.5	0.38	19.1	0.75	345	5,000	1,380	20,000	125	4.92	0.58	0.39	50 250
H290H08 H290H08-250R	12	12.7	0.50	22.1	0.87	293	4,250	1,172	17,000	180	7.09	0.68	0.46	50 250
H290H10	16	15.9	0.62	25.2	0.99	250	3,650	1,000	14,600	205	8.07	0.8	0.54	50
H290H12 H290H12-250R	19	19.0	0.75	29.5	1.16	215	3,125	860	12,500	240	9.45	1	0.67	50 250
H290H16	25	25.4	1.00	37.9	1.49	175	2,550	700	10,200	300	11.81	1.44	0.97	50
H290H20	31	31.8	1.25	48.8	1.92	155	2,250	620	9,000	420	16.54	2.38	1.60	50
H290H24	38	38.1	1.50	54.6	2.15	125	1,800	500	7,200	500	19.68	2.59	1.74	50
H290H32	51	50.8	2.00	68.6	2.70	105	1525	420	6,100	630	24.80	3.38	2.27	50

Construction

Tube: CPE

Reinforcement:
2 wire braids

Cover: CPE black

Operating parameters

-40°C to +150°C
(-40°F to +302°F)

Application

- High pressure hose for hydraulic fluid applications

For more information on agency listings, specific fluid applications and high temperature ratings see section A.

**MSHA accepted,
USCG approved**

Fitting reference	Page
Crimp	
'Z' series	H-29

H245L

WeatherFROST

Meets and exceeds SAE 100R16 Type S, EN857 2SC

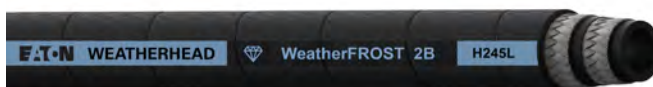

Diamond advantage

- Pressure
- Temperature
- Abrasion resistance

#	Hose I.D.		Hose O.D.		Maximum operating pressure		Minimum burst pressure		Minimum bend radius		Weight		Package length	
	DN	mm	in	mm	in	bar	psi	bar	psi	mm	in	kg/m	lbs/ft	feet
H245L04 H245L04-250R	6	6,4	0.25	13,8	0.54	414	6,000	1656	24,025	51	2.00	0,30	0.20	50 250
H245L06 H245L06-250R	10	9,5	0.38	17,4	0.68	345	5,000	1380	20,025	64	2.50	0,40	0.27	50 250
H245L08 H245L08-250R	12	12,7	0.50	20,8	0.82	310	4,500	1240	18,000	89	3.50	0,58	0.39	50 250
H245L10 H245L10-250R	16	15,9	0.62	24,9	0.98	276	4,000	1104	16,000	102	4.00	0,74	0.50	50 250
H245L12 H245L12-250R	19	19,0	0.75	28,4	1.12	241	3,500	964	14,000	121	4.75	0,92	0.62	50 250
H245L16 H245L16-250R	25	25,4	1.00	35,7	1.41	193	2,800	772	11,200	152	6.00	1,22	0.82	50 250
H245L20	31	31,8	1.25	43,3	1.71	159	2,300	636	9,225	210	8.25	1,59	1.07	50
H245L24	38	38,1	1.50	51,5	2.03	138	2,000	552	8,000	254	10.00	2,11	1.42	50
H245L32	51	50,8	2.00	63,9	2.51	103	1,500	412	6,000	318	12.50	2,80	1.88	50

Construction

Tube: Low temperature Nitrile

Reinforcement:

2 wire braids

Cover: WeatherSHIELD

Operating parameters

-57°C to +100°C
(-70°F to +212°F)

Application

- Low temperature flexing and hydraulic system service with petroleum and water-base fluids
- For use in frigid environments on construction equipment and other mobile applications

For more information on agency listings, specific fluid applications and high temperature ratings see section A.

MSHA accepted

Fitting reference	Page
Crimp	
'Z' series	H-29

Hydraulic hose

Spiral hose - Premium

B

H430

WeatherSHIELD

Meets and exceeds: SAE 100R12, EN856 R12, DIN856/4SP (sizes -8 thru -16)



Diamond advantage

- Pressure
- Temperature
- Abrasion resistance

#	Hose I.D.		Hose O.D.		Maximum operating pressure		Minimum burst pressure		Minimum bend radius		Weight		Package length	
	Part number	DN	mm	in	mm	in	bar	psi	bar	psi	mm	in	kg/m	lbs/ft
H43006 H43006-100	10	9.5	0.38	20.2	0.80	448	6,500	1,792	26,000	62.5	2.46	0.71	0.48	50 100
H43008 H43008-100 H43008-150	12	12.7	0.50	23.6	0.93	415	6,000	1,660	24,000	90.0	3.54	0.87	0.59	50 100 150
H43010	16	15.9	0.62	27.4	1.08	415	6,000	1,660	24,000	100.0	3.94	1.00	0.68	50
H43012 H43012-100 H43012-150	19	19.0	0.75	30.7	1.21	380	5,500	1,520	22,000	120.0	4.72	1.34	0.90	50 100 150
H43016 H43016-100 H43016-150	25	25.4	1.00	37.9	1.49	350	5,100	1,400	20,400	150.0	5.91	1.78	1.20	50 100 150
H43020 H43020-100 H43020-150	31	31.8	1.25	46.6	1.84	310	4,500	1,240	18,000	210.0	8.27	2.41	1.62	50 100 150
H43024 H43024-100 H43024-150	38	38.1	1.50	53.9	2.12	275	4,000	1,100	16,000	250.0	9.84	3.00	2.01	50 100 150
H43032 H43032-100	51	50.8	2.00	66.8	2.63	275	4,000	1,100	16,000	320.0	12.60	4.37	2.94	50 100

Construction

Tube: Nitrile

Reinforcement:
4 wire spiral

Cover: WeatherSHIELD

Operating parameters

-40°C to +126°C
(-40°F to +260°F)

Application

- For very high pressure hydraulic lines subjected to pressure surges and flexing
- Typical applications include construction, mining, farming, and high performance industrial equipment

For more information on agency listings, specific fluid applications and high temperature ratings see section A.

**MSHA accepted
Marine Application
J1942/1 - Hydraulic only,
ABS approved,
DNV approved,
USCG approved**

Fitting reference	Page
Crimp 4S/6S series	H-55

H430R RhinoHide II

Exceeds: SAE 100R12, EN856 R12



B

# Part number	Hose I.D.			Hose O.D.		Maximum operating pressure		Minimum burst pressure		Minimum bend radius		Weight		Package length
	DN	mm	in	mm	in	bar	psi	bar	psi	mm	in	kg/m	lbs/ft	feet
H430R06	10	9.5	0.38	20.2	0.80	280	4,050	1,120	16,200	125	4.92	0.74	0.50	50
H430R08	12	12.7	0.50	23.2	0.92	280	4,050	1,120	16,200	180	7.09	0.86	0.58	50
H430R10	16	15.9	0.62	27.4	1.08	280	4,050	1,120	16,200	200	7.87	1.04	0.70	50
H430R12	19	19.0	0.75	30.7	1.21	280	4,050	1,120	16,200	240	9.45	1.29	0.87	50
H430R16	25	25.4	1.00	38.0	1.50	280	4,050	1,120	16,200	300	11.81	2.08	1.40	50
H430R20	31	31.8	1.25	47.0	1.85	210	3,050	840	12,200	420	16.54	2.74	1.84	50
H430R24	38	38.1	1.50	53.5	2.11	175	2,550	700	10,200	500	19.69	3.12	2.10	50
H430R32	51	50.8	2.00	66.7	2.63	175	2,550	700	10,200	640	25.20	4.18	2.81	50

Construction

Tube: Nitrile

Reinforcement:

4 wire spiral

Cover: UHMWPE

Operating parameters

-40°C to +121°C
(-40°F to +250°F)

Application

- High abrasion applications
- Hydraulic system service with petroleum and water-base fluids
- For general industrial service

For more information on agency listings, specific fluid applications and high temperature ratings see section A.

ABS approved,
DNV approved

Fitting reference	Page
Crimp	
4S/6S series	H-55

Hydraulic hose

Spiral hose - Premium

B

EC525

High temperature

Exceeds: SAE100R12, EN856 R12

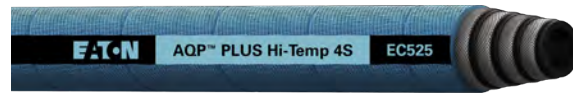

#	Hose I.D.			Hose O.D.		Maximum operating pressure		Minimum burst pressure		Minimum bend radius		Weight	
	Part number	DN	mm	in	mm	in	bar	psi	bar	psi	mm	in	kg/m
EC525-12	19	19,0	0.75	30,7	1.21	345	5,000	1380	20,000	241,3	9.50	1,28	0.86
EC525-16	25	25,4	1.00	37,9	1.49	345	5,000	1380	20,000	304,8	12.00	1,73	1.16
EC525-20	31	31,8	1.25	46,6	1.84	240	3,500	960	14,000	419,1	16.50	2,31	1.55
EC525-24	38	38,1	1.50	53,9	2.12	240	3,500	960	14,000	508,0	20.00	2,96	1.99
EC525-32	51	50,8	2.00	67,3	2.65	225	3,250	900	13,000	635,0	25.00	4,45	2.97

Construction

Tube: CPE

Reinforcement: 4 wire spiral

Cover: CPE blue

Operating parameters

-40°C to +149°C
(-40°F to +300°F)

-40°C to +82°C
(-40°F to +180°F)

phosphate-ester base fluids

Application

- Hydraulic system service with petroleum, fire-resistant and water-based fluids
- Fuel and lubricating systems

For more information on agency listings, specific fluid applications and high temperature ratings see section A.

For additional approved hydraulics fluids reference the fluid compatibility charts shown in Eaton catalogs.

**MSHA approved,
ABS approved,
DNV approved,
USCG approved**

Fitting reference	Page
Crimp	
4S/6S series	H-55

H471

WeatherFORCE - FLEX 5000

Exceeds: SAE 100R13, EN856 R13, 1/2 SAE bend radius



#	Hose I.D.			Hose O.D.		Maximum operating pressure		Minimum burst pressure		Minimum bend radius		Weight		Package length
	Part number	DN	mm	in	mm	in	bar	psi	bar	psi	mm	in	kg/m	lbs/ft
H47112	19	19,0	0.75	31,0	1.22	350	5,100	1,400	20,400	121	4.75	1,28	0.86	50
H47116	25	25,4	1.00	38,4	1.51	350	5,100	1,400	20,400	152	6.00	1,85	1.24	50
H47120	31	31,8	1.25	45,5	1.79	350	5,100	1,400	20,400	210	8.25	2,50	1.68	50
H47124	31	38,1	1.50	53,5	2.11	350	5,100	1,400	20,400	254	10.00	3,38	2.27	50
H47132	51	50,8	2.00	71,8	2.83	350	5,100	1,400	20,400	476	18.75	6,07	4.08	50

Construction

Tube: Nitrile

Reinforcement:

-12 to -24 size: 4 wire spiral

-32 size: 6 wire spiral

Cover: Nitrile

Operating parameters

-40°C to +127°C
(-40°F to +260°F)

Application

- High pressure hydraulic system service with petroleum and water-base fluids

For more information on agency listings, specific fluid applications and high temperature ratings see section A.

For information on additional sizes, please contact your local Eaton sales representative.

**MSHA approved,
ABS approved,
DNV approved,
USCG approved**

Fitting reference	Page
Crimp	
4S/6S series	H-55

Hydraulic hose

Spiral hose - Premium

B

EC600

X-FLEX Spiral

Exceeds SAE 100R15 & ISO 18752-DC performance*,
1/2 SAE bend radius



#	Hose I.D.			Hose O.D.		Maximum operating pressure		Minimum burst pressure		Minimum bend radius		Weight	
	Part number	DN	mm	in	mm	in	bar	psi	bar	psi	mm	in	kg/m
EC600-12	19	19,0	0.75	32,2	1.27	420	6,100	1,680	24,400	135	5.31	1,52	1.01
EC600-16	25	25,4	1.00	38,6	1.52	420	6,100	1,680	24,400	165	6.5	2,04	1.36
EC600-20	31	31,8	1.25	49,7	1.96	420	6,100	1,680	24,400	225	8.86	3,89	2.61

Construction

Tube: Nitrile

Reinforcement:

-12, -16 size: 4 wire spiral
-20 size: 6 wire spiral

Cover: WeatherSHIELD

Operating parameters

-40°C to +121°C
(-40°F to +250°F)

Application

- Hydraulic system service with petroleum and water-based fluids
- For general industrial service

For more information on agency listings, specific fluid applications and high temperature ratings see section A.

MSHA approved,
ABS approved,
DNV approved,
USCG approved

Fitting reference	Page
Crimp 4S/6S**	H-55

* Approved at ISO 18752-DC performance with 1W fitting series

** Approved at ISO 18752-DC performance with 4S/6S fitting series

EC810

ICE CHAMPION premium low temperature

Exceeds: SAE 100R15, EN856 R15 performance

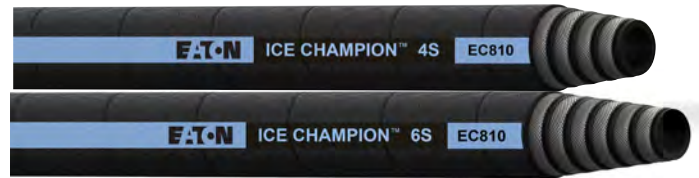

# Part number	Hose I.D.		Hose O.D.		Maximum operating pressure		Minimum burst pressure		Minimum bend radius		Weight		
	DN	mm	in	mm	in	bar	psi	bar	psi	mm	in	kg/m	lbs/ft
EC810-12	19	19,0	0.75	32,2	1.27	420	6,100	1,680	24,360	280	11.02	1,61	1.08
EC810-16	25	25,4	1.00	39,0	1.54	420	6,100	1,680	24,360	340	13.39	2,02	1.36
EC810-20	31	31,8	1.25	49,4	1.95	420	6,100	1,680	24,360	420	16.54	3,55	2.39
EC810-24	38	38,1	1.50	57,3	2.26	420	6,100	1,680	24,360	510	20.08	4,74	3.19
EC810-32	51	50,8	2.00	71,1	2.80	420	5,100	1,490	21,610	630	24.80	6,70	4.50

Construction

Tube: Exclusive low temperature tube

Reinforcement:

-12, -16 size: 4 wire spiral
-20 to -32 size: 6 wire spiral

Cover: Nitrile

Operating parameters

-57°C to +100°C
(-70°F to +212°F)

Application

- Hydraulic system with petroleum based fluids for low temperature applications

For more information on agency listings, specific fluid applications and high temperature ratings see section A.

MSHA approved

Fitting reference	Page
Crimp	
4S/6S series	H-55

Hydraulic hose

Spiral hose - Premium

B

EC850 DYNAMAX

Exceeds: SAE 100R15



# Part number	Hose I.D.			Hose O.D.		Maximum operating pressure		Minimum burst pressure		Minimum bend radius		Weight	
	DN	mm	in	mm	in	bar	psi	bar	psi	mm	in	kg/m	lbs/ft
EC850-10	16	15,9	0.63	29,0	1.14	500	7250	2000	29000	200,0	7.87	1,23	0.82
EC850-12	19	19,0	0.75	33,3	1.31	500	7250	2000	29000	215,0	8.46	1,52	1.01
EC850-16	25	25,4	1.00	40,4	1.59	500	7250	2000	29000	270,0	10.63	2,31	1.54
EC850-20	31	31,8	1.25	50,9	2.00	500	7250	2000	29000	380,0	14.96	4,01	2.69

Construction

Tube: Nitrile

Reinforcement:

-10, -12, -16 size: 4 spiral wire
-20 size: 6 spiral wire

Cover: Nitrile

Operating parameters

-40°C to +100°C
(-40°F to +212°F)

Application

- Ultra high pressure
- Hydraulic systems with petroleum and water-glycol based fluids
- Lubricating oils and water

For more information on agency listings, specific fluid applications and high temperature ratings see section A.

MSHA IC-84, DIN 5510

Fitting reference

Crimp

Contact Eaton for approved Internal Skive fittings (1W series)

H190

WeatherSHIELD

Meets and exceeds: SAE 100R1 Type S, EN853 1SN, ISO 1436-1 Type 1SN Performance



Diamond advantage

- Pressure
- Temperature
- Abrasion resistance

#	Hose I.D.			Hose O.D.		Maximum operating pressure		Minimum burst pressure		Minimum bend radius		Weight		Package length
	Part number	DN	mm	in	mm	in	bar	psi	bar	psi	mm	in	kg/m	
H19004 H19004-250R	6	6,4	0.25	13,5	0.53	255	3,700	1,020	14,800	101,6	4.00	7,3	16	50 250
H19006 H19006-250R	10	9,5	0.38	17,5	0.69	235	3,400	940	13,600	127,0	5.00	11,4	25	50 250
H19008 H19008-250R	12	12,7	0.50	20,6	0.81	200	2,900	800	11,600	177,8	7.00	13,6	30	50 250
H19010	16	15,9	0.63	23,8	0.94	130	1,885	520	7,540	203,2	8.00	15,9	35	50 250
H19012 H19012-250R	19	19,0	0.75	27,8	1.09	138	2,000	552	8,000	241,3	9.50	20,5	45	50 250
H19016 H19016-250R	25	25,4	1.00	35,7	1.41	103	1,500	412	6,000	304,8	12.00	30,9	68	50 250
H19020	31	31,8	1.25	43,4	1.71	69	1,000	276	4,000	419,1	16.50	40,9	88	50
H19024	38	38,1	1.50	50,6	1.99	52	750	208	3,000	508,0	20.00	47,7	105	50
H19032	51	50,8	2.00	64,0	2.52	41	600	164	2,400	635,0	25.00	59,5	131	50

Construction

Tube: Nitrile

Reinforcement: 1 wire braid

Cover: WeatherSHIELD

Operating parameters

Petroleum based
Hydraulic fluids:
-40°C to +127°C
(-40°F to +260°F)

Water-based
Hydraulic Fluids:
-40°C to +70°C
(-40°F to +158°F)

Water:
0°C to 70°C
(+32°F to +158°F)

Application

- Hydraulic system service with petroleum and water-based fluids
- For general industrial service

For more information on agency listings, specific fluid applications and high temperature ratings see section A.

**MSHA accepted
ISO 1436a**

**Marine Application
J1942/1 hydraulic service**

Fitting reference	Page
Crimp	
"Z" Series	H-29

Hydraulic hose

Braided hose - Other

B

H290

WeatherSHIELD

Meets and exceeds: SAE 100R2 Type S, EN853 2SN, ISO 1436-1 Type 2SN performance



Diamond advantage

- Pressure
- Temperature
- Abrasion resistance

#	Hose I.D.			Hose O.D.		Maximum operating pressure		Minimum burst pressure		Minimum bend radius		Weight		Package length
	Part number	DN	mm	in	mm	in	bar	psi	bar	psi	mm	in	kg/m	lbs/ft
H29004 H29004-250R H29004-500R	6	6,4	0.25	15,1	0.59	448	6,500	1792	26,000	101,6	4.00	11,8	26	50 250 500
H29006 H29006-250R H29006-500R	10	9,5	0.38	19,0	0.75	400	5,800	1600	23,200	127,0	5.00	17,3	38	50 250 500
H29008 H29008-250R H29008-500R	12	12,7	0.50	22,2	0.88	345	5,000	1380	20,000	177,8	7.00	20,1	46	50 250 500
H29010 H29010-250R	16	15,9	0.63	25,4	1.00	276	4000	1104	16,000	203,2	8.00	24,5	54	50 250
H29012 H29012-250R	19	19,0	0.75	29,4	1.16	241	3,500	964	14,000	241,3	9.50	30,0	66	50 250
H29016 H29016-250R	25	25,4	1.00	38,1	1.50	207	3,000	828	12,000	304,8	12.00	45,9	101	50 250
H29020 H29020-150R	31	31,8	1.25	48,8	1.92	172	2,500	688	10,000	419,1	16.50	70,0	154	50 250
H29024	38	38,1	1.50	54,6	2.15	138	2,000	552	8,000	508,0	20.00	76,4	168	50
H29032	51	50,8	2.00	63,8	2.51	110	1,600	440	6,400	635,0	25.00	100,9	222	50

Construction

Tube: Nitrile

Reinforcement:
2 wire braids

Cover: WeatherSHIELD

Operating parameters

Petroleum-based

Hydraulic fluids:

-40°C to +127°C
(-40°F to +260°F)

Water-based hydraulic fluids:

-40°C to +70°C
(-40°F to +158°F)

Application

- Hydraulic system service with petroleum and water-based fluids
- For general industrial service

For more information on agency listings, specific fluid applications and high temperature ratings see section A.

MSHA accepted

Fitting reference	Page
Crimp	
'Z' series	H-29

H145

Constant pressure

Meets or exceeds: SAE 100R17



#	Hose I.D.		Hose O.D.		Maximum operating pressure		Minimum burst pressure		Minimum bend radius		Weight		Package length	
	Part number	DN	mm	in	mm	in	bar	psi	bar	psi	mm	in	kg/m	lbs/ft
H14504 H14504-250R H14504-500R	6	6,4	0,25	12,7	0,50	210,0	3,045	840,0	12,180	38,1	2,00	6,8	15	50 250 500
H14506 H14506-250R H14506-500R	10	9,5	0,38	16,3	0,64	210,0	3,045	840,0	12,180	50,8	2,50	10,5	23	50 250 500
H14508 H14508-250R H14508-500R	12	12,7	0,50	20,6	0,81	210,0	3,045	840,0	12,180	58,7	3,50	14,5	32	50 250 500
H14510 H14510-250R	16	15,9	0,63	24,6	0,97	210,0	3,045	840,0	12,180	69,9	4,00	23,2	51	50 250
H14512 H14512-250R	19	19,0	0,75	29,4	1,16	210,0	3,045	840,0	12,180	82,6	4,75	28,6	63	50 250
H14516 H14516-250R	25	25,4	1,00	37,3	1,47	210,0	3,045	840,0	12,180	101,6	6,00	41,4	91	50 250

Construction

Tube: Nitrile

Reinforcement:

4-8 size: 1 wire braid
10-16 size: 2 wire braids

Cover: Neoprene

Operating parameters

4-8 size: -40°C to +121°C
(-40°F to +250°F)

10-16 size: -40°C to +100°C
(-40°F to +212°F)

Application

- Ideal for use in high pressure lines on off-road construction equipment, farm equipment
- Other high pressure applications where a small bend radius is needed

For more information on agency listings, specific fluid applications and high temperature ratings see section A.

Marine Application
J1942/1 - Hydraulic only
MSHA accepted

Fitting reference	Page
Crimp	
'Z' Series	H-29

Hydraulic hose

Braided hose – Other

B

H545

RhinoHide abrasion resistant Constant pressure



# Part number	Hose I.D.			Hose O.D.		Maximum operating pressure		Minimum burst pressure		Minimum bend radius		Weight		Package length
	DN	mm	in	mm	in	bar	psi	bar	psi	mm	in	kg/m	lbs/ft	feet
H54504 H54504-250R H54504-500R	6	6,4	0.25	13,5	0.53	206,9	3,000	827,4	12,000	50,8	2.00	6,4	14	50
H54506 H54506-250R H54506-500R	10	9,5	0.38	15,9	0.63	206,9	3,000	827,4	12,000	63,5	2.50	8,2	18	50
H54508 H54508-250R H54508-500R	12	12,7	0.50	20,6	0.81	206,9	3,000	827,4	12,000	88,9	3.50	14,5	32	50
H54510 H54510-250R	16	15,9	0.63	23,8	0.94	206,9	3,000	827,4	12,000	101,6	4.00	16,8	37	50
H54512 H54512-250R	19	19,0	0.75	28,6	1.13	206,9	3,000	827,4	12,000	120,7	4.75	24,4	54	50
H54516 H54516-250R	25	25,4	1.00	35,7	1.41	206,9	3,000	827,4	12,000	152,4	6.00	39,0	86	50

Construction

Tube: Nitrile

Reinforcement:

4-8 size: 1 wire braid;
10-16 size: 2 wire braids

Cover: Abrasion resistant woven nylon

Operating parameters

-40°C to +121°C
(-40°F to +250°F)

Application

- 3,000 PSI constant working pressure hose with abrasion resistant cover
- Ideal for logging, construction, mining and other off highway applications

For more information on agency listings, specific fluid applications and high temperature ratings see section A.

Fitting reference	Page
Crimp	
'Z' series (-04 thru -12)	H-29
4S/6S series (-16)	H-55

H400 Constant pressure

Meets or exceeds: SAE 100R19

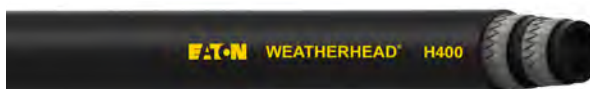

B

# Part number	Hose I.D.			Hose O.D.		Maximum operating pressure		Minimum burst pressure		Minimum bend radius		Weight		Package length
	DN	mm	in	mm	in	bar	psi	bar	psi	mm	in	kg/m	lbs/ft	feet
H40004 H40004-250R	6	6,4	0.25	15,2	0.60	280,0	4,000	1120,0	16,000	50,8	2.00	10,9	24	50 250
H40006 H40006-250R	10	9,7	0.38	19,3	0.76	280,0	4,000	1120,0	16,000	63,5	2.50	16,4	36	50 250
H40008 H40008-250R	12	12,7	0.50	22,6	0.89	280,0	4,000	1120,0	16,000	88,9	3.50	19,5	43	50 250
H40010 H40010-250R	16	16,0	0.63	25,7	1.01	280,0	4,000	1120,0	16,000	101,6	4.00	27,3	60	50 250
H40012 H400-250R	19	19,0	0.75	30,0	1.18	280,0	4,000	1120,0	16,000	120,7	4.75	32,7	72	50 250

Construction

Tube: Nitrile

Reinforcement: 2 wire braids

Cover: Nitrile

Operating parameters

-40°C to +100°C
(-40°F to +212°F)

Application

- High pressure lines
- On off-road equipment, farm equipment and other high pressure applications

For more information on agency listings, specific fluid applications and high temperature ratings see section A.

Fitting reference	Page
-------------------	------

Crimp	
--------------	--

"Z" series	H-29
------------	------

Hydraulic hose

Braided hose - Other

B

H421

WeatherJACK

10,000 psi Jack hose



#	Hose I.D.		Hose O.D.		Maximum operating pressure		Minimum burst pressure		Minimum bend radius		Weight		Package length	
	DN	mm	in	mm	in	bar	psi	bar	psi	mm	in	kg/m	lbs/ft	feet
H42104 H42104-250R	6	6,4	0.25	13,5	0.53	700,0	10,000	1400,0	20,000	50,8	2.00	10,0	22	50 250
H42106 H42106-250R	10	9,7	0.38	17,5	0.69	700,0	10,000	1400,0	20,000	63,5	2.50	13,2	29	50 250

Construction

Tube: Nitrile

Reinforcement:
2 wire braid

Cover: Nitrile

Operating parameters

-40°C to +100°C
(-40°F to +212°F)

Application

- Hydraulic jacking system with petroleum and water-based fluids

For more information on agency listings, specific fluid applications and high temperature ratings see section A.

Fitting reference	Page
Crimp	
"Z" series	H-29

EC230

Large bore

Meets: SAE 100R2 Type S



#	Hose I.D.		Hose O.D.		Maximum operating pressure		Minimum burst pressure		Minimum bend radius		Weight		
	DN	mm	in	mm	in	bar	psi	bar	psi	mm	in	kg/m	lbs/ft
EC230-40	63	63,5	.50	80,2	3.16	79,0	1150	316,0	4600	660,0	26.00	3,88	2.61

Construction

Tube: Nitrile

Reinforcement:
2 wire braid

Cover: Nitrile

Operating parameters

-40°C to +100°C
(-40°F to +212°F)

Application

- Hydraulic system service with petroleum and water-based fluids
- For general industrial service

For more information on agency listings, specific fluid applications and high temperature ratings see section A.

Fitting reference
For fitting information, refer to Eaton bulletin E-HOBR-BB001-E

H345 Pressure washer hose

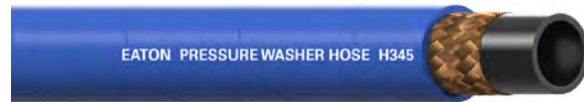

# Part number	Hose I.D.			Hose O.D.		Maximum operating pressure		Minimum burst pressure		Minimum bend radius		Weight		Package length
	DN	mm	in	mm	in	bar	psi	bar	psi	mm	in	kg/m	lbs/ft	feet
H34504 H34504-100 H34504-250R H34504-500R	6	6,4	0.25	12,3	0.48	206,9	3,000	827,4	12,000	50,8	2.00	5,9	13	50* 100* 250 500
H34506 H34506-100 H34506-250R H34506-500R	6	6,4	0.38	16,3	0.64	206,9	3,000	827,4	12,000	63,5	2.50	8,2	18	50* 100* 250 500
H34508 H34508-100 H34508-250R H34508-500R	12	12,7	0.50	19,8	0.78	206,9	3,000	827,4	12,000	88,9	3.50	12,7	28	50* 100* 250 500

*50 and *100 are one continuous length.

Construction

Tube: Nitrile

Reinforcement:

1 wire braid

Cover: Blue Nitrile

Operating parameters

Pressure washer service up to
180°C to +93°C
(-0°F to +200°F)

Hydraulic Service
-40°C to +121°C
(-40°F to +250°F)

Application

- Pressure washer hose for cold and hot water
- Resistant to usual detergents

Not for use with steam applications.

MSHA accepted, IC-46/10

For more information on agency listings, specific fluid applications and high temperature ratings see section A.

Fitting reference	Page
Crimp	
"Z" Series	H-29

Hydraulic hose

Spiral hose - Other

B

H464 4S

Meets EN856 Type 4SH



#	Hose I.D.			Hose O.D.		Maximum operating pressure		Minimum burst pressure		Minimum bend radius		Weight		Package length
	Part number	DN	mm	in	mm	in	bar	psi	bar	psi	mm	in	kg/m	lbs/ft
H46412	19	19,0	0.75	32,5	1.27	420,0	6,090	1679,6	24,360	279,4	11.00	45,4	100	50
H46416	25	25,4	1.00	38,1	1.50	385,0	5,510	1519,7	22,040	339,9	13.38	62,6	138	50
H46420	31	31,8	1.25	42,2	1.79	350,0	5,075	1399,7	20,300	460,0	18.11	77,6	171	50
H46424	38	38,1	1.50	54,0	2.11	300,0	4,350	1199,7	17,400	560,1	22.05	99,8	220	50
H46432	51	50,8	2.00	68,3	2.68	250,0	3,625	999,8	14,500	700,0	27.5	139,7	308	50

Construction

Tube: Nitrile

Reinforcement:
4 spiral wire plies

Cover: Nitrile

Operating parameters

-40°C to +100°C
(-40°F to +212°F)

Application

- Perfect for hydraulic system service with petroleum and water-based fluids requiring premium pressure performance and durability
- This hose is well suited for injection mold and drill rig applications

For more information on agency listings, specific fluid applications and high temperature ratings see section A.

Fitting reference	Page
Crimp	
4S/6S series	H-55

EC910

SAFESHIELD Waterblast

Meets: ISO 7751, EN1829-2 (impulse)



#	Hose I.D.			Hose O.D.		Maximum operating pressure		Minimum burst pressure		Minimum bend radius		Weight	
	Part number	DN	mm	in	mm	in	bar	psi	bar	psi	mm	in	kg/m
EC910-08C50	12	12,7	0.50	24,6	0.97	1100,0	16000	2750,0	40000	228,6	9.00	1,12	0.75
EC910-12C50	19	19,0	0.75	32,8	1.29	1000,0	14500	2500,0	36250	279,4	11.00	1,74	1.17
EC910-16C50	25	25,4	1.00	39,9	1.57	690,0	10000	1725,0	25000	304,8	12.00	2,23	1.50

Construction

Tube: Nitrile

Reinforcement: Heavy
4 spiral wire

Cover: Nitrile cover with color coded lay lines in accordance with WJTA (Water Jetting Technology Association)

Operating parameters

-40°C to +93°C
(-40°F to +200°F)
Continuous service temperature range
-10°C to +80°C
(-14°F to +176°F)

Application

- Waterblast service with water, water-soap emulsion

For more information on agency listings, specific fluid applications and high temperature ratings see section A.

Fitting reference
Contact Eaton for approved Internal skive fittings and sockets.

** Refer to Eaton bulletin E-HOHP-MS003-E









H039

Suction hose

Meets: SAE 100R4, 1/2 SAE bend radius



B

#																
	Part number	Hose I.D.			Hose O.D.		Maximum operating pressure		Minimum burst pressure		Minimum bend radius		Vacuum Service		Weight	
	DN	mm	in	mm	in	bar	psi	bar	psi	mm	in	kPa	lbs/ft	kg/m	lbs/ft	feet
H03912 H03912-100 H03912-150	19	19,0	0.75	32,5	1.28	20,1	300	82,7	1,200	63,5	2.50	94,8	28.0	20,0	0.44	50 100 150
H03916 H03916-100 H03916-150	25	25,4	1.00	38,1	1.50	17,2	250	69,0	1,000	76,2	3.00	94,8	28.0	23,6	0.52	50 100 150
H03920 H03920-100 H03920-150	31	31,8	1.25	46,4	1.83	113,8	200	55,2	800	101,6	4.00	94,8	28.0	34,0	0.75	50 100 150
H03924 H03924-100 H03924-150	38	38,1	1.50	52,8	2.08	10,3	150	41,4	600	127,0	5.00	94,8	28.0	38,6	0.85	50 100 150
H03932 H03932-100 H03932-150	51	50,8	2.00	66.3	2.61	6,9	100	27,6	400	152,4	6.00	94,8	28.0	52,6	0.116	50 100 150

Construction

Tube: CPE

Reinforcement:

1 helical cable wire between two textile layers, 1 fiber braid

Cover: Neoprene

Operating parameters

-40°C to +135°C
(-40°F to +275°F)

Application

- Hydraulic suction hose

MSHA accepted

Marine Application
J1942/1 - Hydraulic only.

ABS approved

For more information on agency listings, specific fluid applications and high temperature ratings see section A.

Fitting reference	Page
Crimp	
"Z" Series	H-29

Hydraulic hose

Suction hose - Specialty

B

H039H

WeatherBLAZE suction hose

Meets: SAE 100R4



# Part number	Hose I.D.			Hose O.D.		Maximum operating pressure		Minimum burst pressure		Minimum bend radius		Vacuum Service		Weight		Package length
	DN	mm	in	mm	in	bar	psi	bar	psi	mm	in	kPa	in/Hg	kg/m	lbs/ft	feet
H039H12 H039H12-100 H039H12-150	19	19,0	0.75	32,5	1.28	20,1	300	82,7	1,200	125,0	5.00	94,8	28.0	20,0	44	50 100 150
H039H16 H039H16-100 H039H16-150	25	25,4	1.00	38,1	1.50	17,2	250	69,0	1,000	150,0	6.00	94,8	28.0	23,6	52	50 100 150
H039H20 H039H20-100 H039H20-150	31	31,8	1.25	46,4	1.83	13,8	200	55,2	800	200,0	8.00	94,8	28.0	34,0	75	50 100 150
H039H24 H039H24-100 H039H24-150	38	38,1	1.50	52,8	2.08	10,3	150	41,4	600	255,0	10.00	94,8	28.0	38,6	85	50 100 150
H039H32 H039H32-100 H039H32-150	51	50,8	2.00	66,3	2.61	6,9	100	27,6	400	300,0	12.00	94,8	28.0	52,6	116	50 100 150

Construction

Tube: CPE

Reinforcement:

1 helical wire between
2 textile layers, 1 fiber braid

Cover: CPE blue

Operating parameters

-40°F to +302°F
(-40°C to +150°C)

Application

- Hydraulic suction hose

For more information on agency listings, specific fluid applications and high temperature ratings see section A.

Fitting reference	Page
Crimp	
"Z" Series	H-29

3130

Synflex medium pressure

Meets or exceeds: SAE 100R7



#	Hose size	Hose I.D.		Hose O.D.		Maximum operating pressure		Minimum burst pressure		Minimum bend radius		Weight		Package length		
		DN	mm	in	mm	in	bar	psi	bar	psi	mm	in	kg/m	lbs/ft	mtr	ft
3130-02-250BX	-02	3	3,2	0.13	8,5	0.34	172	2,500	689	10,000	13,0	0.50	0,04	0.03	76,2	250
3130-03-250BX	-03	5	4,8	0.19	10,8	0.43	207	3,000	827	12,000	19,0	0.75	0,07	0.05	76,2	250
3130-04-250BX	-04	6	6,4	0.25	13,0	0.51	207	3,000	759	11,000	32,0	1.25	0,09	0.06	76,2	250
3130-04-500R	-04	6	6,4	0.25	13,0	0.51	207	3,000	759	11,000	32,0	1.25	0,09	0.06	152,4	500
3130-05-250BX	-05	8	7,9	0.31	15,1	0.59	172	2,500	689	10,000	44,0	1.75	0,12	0.08	76,2	250
3130-06-250BX	-06	10	9,5	0.38	17,0	0.67	155	2,250	620	9,000	51,0	2.00	0,12	0.08	76,2	250
3130-06-500R	-06	10	9,5	0.38	17,0	0.67	155	2,250	620	9,000	51,0	2.00	0,12	0.08	152,4	500
3130-08-250BX	-08	12	12,7	0.50	20,7	0.82	138	2,000	620	9,000	76,0	3.00	0,16	0.11	76,2	250
3130-08-500R	-08	12	12,7	0.50	20,7	0.82	138	2,000	620	9,000	76,0	3.00	0,16	0.11	152,4	500
3130-12-200BX	-12	19	19,0	0.75	27,1	1.07	86	1,250	345	5,000	127,0	5.00	0,27	0.18	60,9	200
3130-16-200BX	-16	25	25,4	1.00	34,0	1.34	69	1,000	276	4,000	203,0	8.00	0,46	0.31	60,9	200

SAE100R7 does not apply to 0.125" size. The nylon core tube is a single wall and not bonded to the reinforcement.

BX = Box part numbers, and R = Reel part numbers.

Construction

Tube: Nylon-lined

Reinforcement: Spiral or braided synthetic fiber

Cover: Black perforated polyurethane

Operating parameters

-40°C to +100°C
(-40°F to +212°F) or

-40°C to +66°C
(-40°F to +150°F)
with water-based, or
fire-resistant fluids

Change in working length at
working PSI ±2%

Application

- General hydraulics
- Material handling
- Forklifts
- Chemical transfer
- Marine steering

Features

- Low elongation

Fitting reference

For hose fittings details refer to
Synflex catalog E-HOOV-MC001-E.

Hydraulic hose

Thermoplastic hose

B

3740

Synflex medium pressure, non-conductive

Meets or exceeds: SAE 100R7



#	Hose size	Hose I.D.		Hose O.D.		Maximum operating pressure		Minimum burst pressure		Minimum bend radius		Weight		Package length	
		DN	mm in	mm in	bar psi	bar psi	mm in	kg/m lbs/ft	mtr ft						
3740-04-250BX 3740-04-250RC 3740-04-500R	-04	6	6,4 .25	12,9 .51	192 2800	768 11,200	31,8 1.25	0,11 0.07	76,2 250 76,2 250 152,4 500						
3740-05-250BX 3740-05-250RC 3740-05-250R	-05	8	7,9 .31	15,0 .59	175 2550	700 10200	44,4 1.75	1,29 0.87	76,2 250 76,2 250 152,4 500						
3740-06-250BX 3740-06-250RC 3740-06-500R	-06	10	9,5 .38	16,9 .67	157 2300	628 9,200	50,8 2.00	0,15 0.10	76,2 250 76,2 250 152,4 500						
3740-08-250BX 3740-08-250RC 3740-08-500R	-08	12	12,7 .50	20,8 .82	140 2050	560 8,200	76,2 3.00	0,21 0.14	76,2 250 76,2 250 152,4 500						
3740-12-200BX 3740-12-200RC	-12	19	19,0 0.75	27,2 1.07	86 1250	348 5,000	127,0 5.00	0,29 0.19	60,9 200						
3740-16-050BX	-16	25	25,4 1.00	34,1 1.34	70 1000	280 4,000	203,2 8.00	0,39 0.26	15,2 50						

BX = Box part numbers, R = Random length reel part numbers, RC= Continuous length reel

Construction

Tube: Nylon-lined

Reinforcement:
Braided synthetic fiber reinforcement (-08)

Cover: Orange non-perforated polyurethane

Operating parameters

-40°C to +100°C
(-40°F to +212°F) for petroleum or synthetic based hydraulic fluids

-40°C to +66°C
(-40°F to +150°F) for water-based, or fire-resistant fluids

Change in working length at working PSI ±2%

Application

- General hydraulic systems that may contact high voltage sources
- Aerial equipment
- Mobile hydraulics
- Rescue apparatus and tools

Features

- SAE J517 non-conductive hose construction
- Less than 50 micro-amperes leakage when subjected to 75,000 volts/ft for five minutes

Fitting reference

For hose fittings details refer to Synflex catalog E-HOOV-MC001-E.

37AL

Synflex medium pressure, non-conductive

Meets: SAE 100R7 conductive requirements



#	Hose size	Hose I.D.		Hose O.D.		Maximum operating pressure ANSI A92.2 SAE 100R7		Minimum burst pressure		Minimum bend radius		Weight		Package length	
		DN	mm in	mm in	bar psi	bar psi	bar psi	mm in	kg/m lbs/ft	mtr ft					
37AL-03-250BX	-03	5	4,8 0.19	10,8 0.43	207 3,000	207 3,000	827 12,000	19,1 0.4	0,07 0.05	76,2 250					
37AL-04-250BX	-04	6	6,4 0.25	12,3 0.49	207 3,000	190 2,750	759 11,000	32,0 1.3	0,09 0.06	76,2 250					
37AL-04-500RC	-04	6	6,4 0.25	12,3 0.49	207 3,000	190 2,750	759 11,000	32,0 1.3	0,09 0.06	152,4 500					
37AL-05-250BX	-05	8	7,9 0.31	14,7 0.58	207 3,000	172 2,500	689 10,000	44,0 1.8	0,11 0.08	76,2 250					
37AL-05-500RC	-05	8	7,9 0.31	14,7 0.58	207 3,000	172 2,500	689 10,000	44,0 1.8	0,11 0.08	152,4 500					
37AL-06-250BX	-06	10	9,5 0.38	16,1 0.64	207 3,000	155 2,250	620 9,000	51,0 2.0	0,14 0.10	76,2 250					
37AL-06-500RC	-06	10	9,5 0.38	16,1 0.64	207 3,000	155 2,250	620 9,000	51,0 2.0	0,14 0.10	152,4 500					
37AL-08-250BX	-08	12	12,7 0.50	20,7 0.82	207 3,000	155 2,250	620 9,000	76,0 3.0	0,21 0.14	76,2 250					
37AL-08-500RC	-08	12	12,7 0.50	20,7 0.82	207 3,000	155 2,250	620 9,000	76,0 3.0	0,21 0.14	152,4 500					

BX = Box part numbers, RC= Continuous length reel

Construction

Tube: Polyester

Reinforcement: Braided synthetic fiber

Cover: Orange, non-perforated, non-stick polyurethane

Operating parameters

-54°C to +100°C
(-65°F to +212°F) or

-40°C to +60°C
(-40°F to +140°F)
with water-based, or fire-resistant fluids

Change in working length at working PSI ±2%

Application

- Electric utility truck
- Hydraulic systems
- Mobile equipment (pickers, utility vehicles)

Features

- SAE J517 non-conductive hose construction
- Complies with ANSI A92.2 for vehicle-mounted, aerial devices (i.e., AL)
- Less than 50 micro-amperes leakage when subjected to 75,000 volts/ft for five minutes

Fitting reference

For hose fittings details refer to Synflex catalog E-HOOV-MC001-E.

Hydraulic hose

Thermoplastic hose

B

3R80

Synflex High pressure

Meets: SAE 100R8



#	Hose size	Hose I.D.		Hose O.D.		Maximum operating pressure		Minimum burst pressure		Minimum bend radius		Weight		Package length		
		DN	mm	in	mm	in	bar	psi	bar	psi	mm	in	kg/m	lbs/ft	mtr	ft
3R80-03-250BX	-03	5	4,8	0.19	13,1	0.52	350	5,100	1,400	20,400	38,0	1.50	0,11	0.08	76,2	250
3R80-04-250BX	-04	6	6,4	0.25	15,9	0.63	350	5,100	1,400	20,400	51,0	2.00	0,18	0.12	76,2	250
3R80-06-250BX	-06	10	9,5	0.38	19,4	0.77	280	4,050	1,120	16,200	64,0	2.50	0,22	0.15	76,2	250
3R80-08-250BX	-08	12	12,7	0.50	22,7	0.90	245	3,550	980	14,200	102,0	4.00	0,28	0.19	76,2	250
3R80-12-200BX	-12	19	19,0	0.75	28,9	1.14	157	2,300	628	9,200	165,0	6.50	0,38	0.26	60,9	200
3R80-16-200BX	-16	25	25,4	1.00	37,3	1.47	140	2,050	560	8,200	254,0	10.00	0,57	0.39	60,9	200

BX = Box part numbers

Construction

Tube: Nylon

Reinforcement: Braided synthetic fiber

Cover: Black perforated polyurethane

Operating parameters

-40°C to +100°C
(-40°F to +212°F) or

-40°C to +66°C
(-40°F to +150°F)
with water-based, or
fire-resistant fluids

Change in working length at
working PSI ±2%

Application

- General hydraulic systems
- Hydraulic tools
- Mobile equipment
- High-pressure chemical transfer

Fitting reference

For hose fittings details refer to
Synflex catalog E-HOOV-MC001-E.

3E80

Synflex High pressure, non-conductive

Meets: SAE 100R8



#	Hose size	Hose I.D.		Hose O.D.		Maximum operating pressure		Minimum burst pressure		Minimum bend radius		Weight		Package length		
		DN	mm	in	mm	in	bar	psi	bar	psi	mm	in	kg/m	lbs/ft	mtr	ft
3E80-03-050BX	-03	5	4,8	0.19	13,1	0.52	350	5,100	1,400	20,400	38,0	1.50	0,11	1.50	15,2	50
3E80-04-250BX	-04	6	6,4	0.25	15,9	0.63	350	5,100	1,400	20,400	51,0	2.00	0,18	0.12	76,2	250
3E80-06-250BX	-06	10	9,5	0.38	19,4	0.77	280	4,050	1,120	16,200	64,0	2.50	0,22	0.15	76,2	250
3E80-08-250BX	-08	12	12,7	0.50	22,7	0.90	245	3,550	980	14,200	102,0	4.00	0,28	0.19	76,2	250

BX = Box part numbers

Contact your Eaton customer service representative for details.

Construction

Tube: Nylon

Reinforcement: Braided synthetic fiber

Cover: Orange, non-perforated polyurethane

Operating parameters

-54°C to +100°C
(-65°F to +212°F) or

-40°C to +66°C
(-40°F to +150°F)
with water-based, or
fire-resistant fluids

Change in working length at
working PSI ±2%

Application

- General hydraulic systems that may contact high voltage sources
- Aerial equipment
- Mobile machinery
- Rescue tools

Features

- SAE J517 non-conductive hose construction
- Less than 50 micro-amperes leakage when subjected to 75,000 volts/ft for five minutes

Fitting reference

For hose fittings details refer to
Synflex catalog E-HOOV-MC001-E.

30CT

Synflex Constant pressure

Meets: SAE 100R18



#	Hose size	Hose I.D.		Hose O.D.		Maximum operating pressure		Minimum burst pressure		Minimum bend radius		Weight		Package length		
		DN	mm	in	mm	in	bar	psi	bar	psi	mm	in	kg/m	lbs/ft	mtr	ft
30CT-03-250BX	-03	5	4,8	0.19	10,7	0.42	210	3,050	840	12,200	25,4	1.00	0,08	0.05	15,2	50
30CT-04-250BX	-04	6	6,4	0.25	12,1	0.48	210	3,050	840	12,200	31,8	1.25	0,09	0.06	76,2	250
30CT-05-250BX	-05	8	7,9	0.31	15,5	0.61	210	3,050	840	12,200	38,1	1.50	0,15	0.10	76,2	250
30CT-06-250BX	-06	10	9,5	0.38	16,8	0.66	210	3,050	840	12,200	50,8	2.00	0,18	0.12	76,2	250
30CT-08-250BX	-08	12	12,7	0.50	21,6	0.85	210	3,050	840	12,200	88,9	3.50	0,25	0.17	76,2	250
30CT-10-250BX	-10	16	16,0	0.63	27,0	1.06	210	3,050	840	12,200	101,6	4.00	0,41	0.28	76,2	250

BX = Box part numbers

Construction

Tube: Polyester

Reinforcement: Braided synthetic fiber

Cover: Black perforated, non-stick polyester

Operating parameters

-54°C to +94°C
(-65°F to +200°F) or

-54°C to +66°C
(-65°F to +150°F)
with water-based, or fire-resistant fluids

Change in working length at working PSI \pm 2%

Application

- Forklifts
- Construction
- General hydraulics
- Chemical and gas transfer
- Agricultural equipment
- Material handling
- Freezer applications
- Machine tools and robotics
- Lubrication equipment
- Portable hydraulic tools

Features

- Highly flexible, even in cold temperatures
- Small outside diameter
- Lightweight, yet rugged construction

Fitting reference

For hose fittings details refer to Synflex catalog E-HOOV-MC001-E.

Hydraulic hose

Thermoplastic hose

B

3V10

Synflex Very high pressure



# Part number	Hose size	Hose I.D.		Hose O.D.		Maximum operating pressure		Minimum burst pressure		Minimum bend radius		Weight		Package length		
		DN	mm	in	mm	in	bar	psi	bar	psi	mm	in	kg/m	lbs/ft	mtr	ft
3V10-03-250BX	-03	5	4,8	0.19	13,2	0.52	689	10,000	2,758	40,000	38,0	1.50	0,11	0.08	76,2	250
3V10-04-250BX	-04	6	6,4	0.25	15,1	0.60	689	10,000	2,758	40,000	64,0	2.50	0,16	0.11	76,2	250
3V10-06-250BX	-06	10	9,5	0.38	19,8	0.78	552	8,000	2,205	32,000	76,0	3.00	0,23	0.16	76,2	250

Construction

Tube: Nylon-lined

Reinforcement: Spiral, high-tensile aramid fiber

Cover: Black, perforated polyurethane

Operating parameters

-40°C to +66°C
(-40°F to +150°F)

Change in working length at working PSI ±2%

Application

- High pressure hydraulic tools
- Rescue equipment and tools
- High pressure test equipment

Features

- Compact size
- Lightweight
- Low elongation

Fitting reference

For hose fittings details refer to Synflex catalog E-HOOV-MC001-E.



3V10 hose assembly includes:

- 3V10 hose
- 90V permanent steel fitting
- 45J0 hose guard
- Warning tag

3V10 Kit chart

Warning Tags and Guard Part Numbers

Hose	Tag Number	Hose Guard Kits for Assemblies 30-60 Inches*	Hose Guard Kits for Assemblies over 60 Inches*
3V10-03	0112-23170	45J0-01113	45J0-01107
3V10-04	0112-23170	45J0-01114	45J0-01108
3V10-06	0112-23047	45J0-01115	45J0-01109

*Each kit contains 2 hose guards.

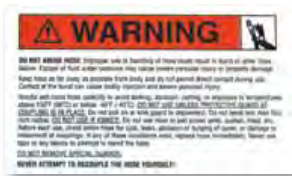

3VE0

Synflex Very high pressure, non-conductive



# Part number	Hose size	Hose I.D.		Hose O.D.		Maximum operating pressure		Minimum burst pressure		Minimum bend radius		Weight		Package length		
		DN	mm	in	mm	in	bar	psi	bar	psi	mm	in	kg/m	lbs/ft	mtr	ft
3VE0-03-250BX	-03	5	4,8	0.19	13,2	0.52	689	10,000	2,758	40,000	38,0	1.50	0,11	0.08	76,2	250
3VE0-04-250BX	-04	6	6,4	0.25	15,1	0.60	689	10,000	2,758	40,000	64,0	2.50	0,16	0.11	76,2	250
3VE0-06-250BX	-06	10	9,5	0.38	19,8	0.78	551	8,000	2,206	32,000	76,0	3.00	0,23	0.16	76,2	250

Synflex 3VE0 hose is available only as completed assemblies through the factory or Eaton Synflex authorized assemblers.

Construction

Tube: Nylon-lined

Reinforcement: Spiral high-tensile aramid fiber

Cover: Orange, non-perforated polyurethane

Operating parameters

-40°C to +66°C
(-40°F to +150°F)

Change in working length at working PSI ±2%

Application

- General hydraulic systems that may contact high voltage sources
- Rescue equipment and tools
- Mobile machinery
- Aerial equipment

Features

- SAE J517 non-conductive hose construction. Less than 50 micro-amperes leakage when subjected to 75,000 volts/ft for five minutes
- Compact size
- Low elongation

Fitting reference

For hose fittings details refer to Synflex catalog E-HOOV-MC001-E.



3VE0 hose assembly includes:

- 3VE0 hose
- 90V permanent steel fitting
- 45J0 hose guard
- Warning tag

3VE0 Kit chart

Warning Tags and Guard Part Numbers

Hose	Tag Number	Hose Guard Kits for Assemblies 30-60 Inches*	Hose Guard Kits for Assemblies over 60 Inches*
3VE0-03	0112-23171	45J0-01113	45J0-01107
3VE0-04	0112-23171	45J0-01114	45J0-01108
3VE0-06	0112-23045	45J0-01115	45J0-01109

*Each kit contains 2 hose guards.

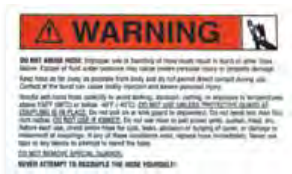

Hydraulic hose

Thermoplastic hose

B

3130, 37AL and 30CT

Twin-line thermoplastic hose

3130 Medium pressure hose

Meets: SAE 100R7



# Part number	Hose size	Number of hose	Hose I.D.		Package length	
			mm	in	mtr	ft
3130-04-2-250BX*	3130-04	2	6,3	0.25	76,2	250
3130-05-2-250BX*	3130-05	2	7,9	0.31	76,2	250
3130-06-2-250BX*	3130-06	2	9,7	0.38	76,2	250
3130-08-2-250BX*	3130-08	2	12,7	0.50	76,2	250

* 3130 Twin-line hose is a stock item. Other 3130 multi-line hoses are built to order. See 3130 series hose on page B-29 for specification details. Please contact Eaton customer service for twin-line, tri-line, and multi-line configuration options.

37AL Medium pressure hose, non-conductive

Meets: SAE 100R7



# Part number	Hose size	Number of hose	Hose I.D.		Package length	
			mm	in	mtr	ft
37AL-04-2-250BX*	37AL-04	2	6,3	0.25	76,2	250
37AL-06-2-250BX*	37AL-06	2	9,7	0.38	76,2	250
37AL-08-2-250BX*	37AL-08	2	12,7	0.50	76,2	250

* 37AL Twin-line hose is a stock item. Other 37AL multi-line hoses are built to order. See 37AL series hose on page B-31 for specification details. Please contact Eaton customer service for twin-line, tri-line, and multi-line configuration options.

30CT Constant pressure hose

Meets: SAE 100R18



# Part number	Hose size	Number of hose	Hose I.D.		Package length	
			mm	in	mtr	ft
30CT-04-2-250BX*	30CT-04	2	6,3	0.25	76,2	250
30CT-05-2-250BX*	30CT-05	2	7,9	0.31	76,2	250
30CT-06-2-250BX*	30CT-06	2	9,7	0.38	76,2	250
30CT-08-2-250BX*	30CT-08	2	12,7	0.50	76,2	250

* 30CT Twin-line hose is a stock item. Other 30CT multi-line hoses are built to order. See 30CT series hose on page B-33 for specification details. Please contact Eaton customer service for twin-line, tri-line, and multi-line configuration options.

Twin-Line and multi-line hose separating tool and instructions are in the Synflex Thermoplastic Hose and Fittings catalog E-HOOV-MC001-E.

Fitting reference

For hose fittings details refer to Synflex catalog E-HOOV-MC001-E.

General purpose hose

H009	C-3	H201	C-7	C
H017	C-4	H332	C-8	
H100	C-5	H275	C-8	
H101	C-6			

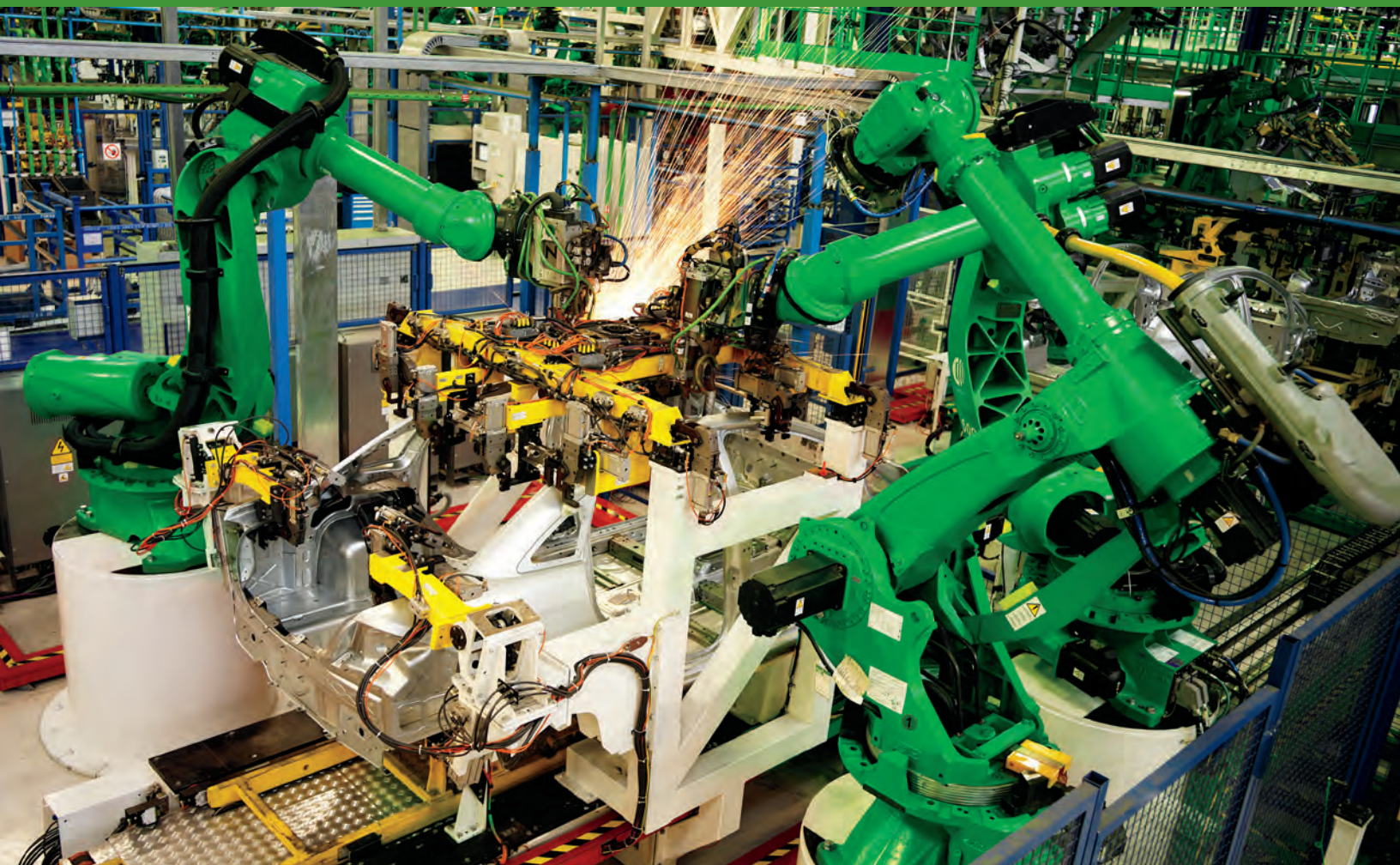

General purpose

C

H009 General purpose hose C-3



H201 EASY COUPLE hose C-7



H017 General purpose hose C-4



H332 General purpose hose C-8



H100 General purpose hose C-5



H275 POLYFORCE II hose C-8



H101 General purpose hose C-6



H009

General purpose hose

SAE 100R6



# Part number	Hose I.D.			Hose O.D.		Maximum operating pressure		Minimum burst pressure		Minimum bend radius		Weight		Package length
	DN	mm	in	mm	in	bar	psi	bar	psi	mm	in	kg/m	lbs/ft	feet
H00904-25R H00904-50R H00904-250R	6	6,4	0.25	13,5	0.53	28	400	112	1,600	63,5	2.50	0,15	0.10	25 50 250
H00905-25R H00905-50R H00905-250R	8	7,9	0.31	15,0	0.59	28	400	112	1,600	75,0	3.00	0,18	0.12	25 50 250
H00906-25R H00906-50R H00906-250R	10	9,5	0.38	16,5	0.65	28	400	112	1,600	75,0	3.00	0,19	0.13	25 50 250
H00908* H00908-25R H00908-250R	13	12,7	0.50	20,3	0.80	28	400	112	1,600	100,0	4.00	0,27	0.18	- 25 250

* 50 foot carton

Construction

Tube: Nitrile

Reinforcement:

1 textile braid

Cover: Neoprene

Operating parameters

-40°C to +100°C
(-40°F to +212°F)

Application

- General purpose air, oil and water lines
- Low pressure hydraulic service

For more information on agency listings, specific fluid applications and high temperature ratings see section A.

Fitting reference	Page
Crimp	
'E' Series (-5 to -8)	H-2
Field Attachable	
009 'B' Series (-04 only)	I-8

General purpose

C

H017 Hydraulic hose

Meets: SAE 100R3



# Part number	Hose I.D.			Hose O.D.		Maximum operating pressure		Minimum burst pressure		Minimum bend radius		Weight		Package length
	DN	mm	in	mm	in	bar	psi	bar	psi	mm	in	kg/m	lbs/ft	feet
H01704 H01704-250R	6	6,4	0.25	14,6	0.57	86	1,250	344	5,000	76,2	3.00	0,19	.13	50 250
H01706 H01706-250R	10	9,5	0.38	19,3	0.76	78	1,125	312	4,000	76,2	4.00	0,30	.20	50 250
H01708 H01708-250R	12	12,7	0.50	24,0	0.94	70	1,000	280	4,000	76,2	5.00	0,42	.28	50 250
H01712 H01712-250R	19	19,0	0.75	32,5	1.28	52	750	208	3,000	127,	6.00	0,74	.50	50 250
H01716 H01716-250R	25	25,4	1.00	38,4	1.51	39	565	156	2,250	152,4	8.00	0,95	.64	50 250
H01720	31	31,8	1.25	46,0	1.81	26	375	104	1,500	177,8	10.00	1,00	.68	50

Construction

Tube: Nitrile

Reinforcement:
2 textile braids

Cover: Neoprene

Operating parameters

-40°C to +100°C
(-40°F to +212°F)

Application

- Low pressure fuel and oil lines
- Hydraulic return lines

For more information on agency listings, specific fluid applications and high temperature ratings see section A.

Marine Application
J1942/1/1 - Hydraulic only

MSHA Accepted

Fitting reference

Crimp

"U" series: See Catalog
W-HYOV-MC002-E3 (section-J)
for available "U" series fittings.

H100 General purpose hose

Fabric cover



# Part number	Hose I.D.			Hose O.D.		Maximum operating pressure		Minimum burst pressure		Minimum bend radius		Weight		Package length
	DN	mm	in	mm	in	bar	psi	bar	psi	mm	in	kg/m	lbs/ft	feet
H10004 H10004-250R	6	6,4	0.25	13,2	0.53	24	350	98	1,400	76,2	3.00	0,12	0.08	50 250
H10005 H10005-250R	8	7,9	0.31	14,2	0.56	24	350	98	1,400	76,2	3.00	0,15	0.10	50 250
H10006 H10006-250R	10	9,5	0.38	16,5	0.65	24	350	98	1,400	76,2	3.00	0,15	0.10	50 250
H10008 H10008-250R	13	12,7	0.50	19,6	0.77	24	350	98	1,400	127,0	5.00	0,21	0.14	50 250
H10010 H10010-250R	16	15,9	0.63	24,1	0.95	24	350	98	1,400	152,4	6.00	0,25	0.17	50 250
H10012 H10012-250R	19	19,0	0.75	26,9	1.06	24	350	98	1,400	177,8	7.00	0,30	0.20	50 250

Construction

Tube: Nitrile

Reinforcement:
1 textile braid

Cover: Textile braid - Black

Operating parameters

-40°C to +100°C
(-40°F to +212°F)

Application

- General purpose low pressure air, diesel fuel, oil and water lines

For more information on agency listings, specific fluid applications and high temperature ratings see section A.

Fitting reference	Page
Field Attachable	
100 "B" series	I-11

General purpose

C

H101

General purpose hose

Rubber cover



# Part number	Hose I.D.			Hose O.D.		Maximum operating pressure		Minimum burst pressure		Minimum bend radius		Weight		Package length
	DN	mm	in	mm	in	bar	psi	bar	psi	mm	in	kg/m	lbs/ft	feet
H10104 H10104-250R H10104-500R	6	6,4	0.25	13,2	0.53	28	400	140	2,000	76,2	3.00	0,13	0.09	50 250 500
H10105-25 H10105 H10105-250R	8	7,9	0.31	14,2	0.56	24	350	98	1,400	76,2	3.00	0,16	0.11	25 50 250
H10106-25 H10106 H10106-250R H10106-370R	10	9,5	0.38	16,5	0.65	28	400	140	2,000	76,2	3.00	0,19	0.13	25 50 250 370
H10108 H10108-250R	13	12,7	0.50	19,6	0.77	28	400	140	2,000	127,0	5.00	0,22	0.15	50 250
H10110 H10110-250R	16	15,9	0.63	24,1	0.95	24	350	98	1,400	152,4	6.00	0,34	0.23	50 250
H10112 H10112-250R	19	19,0	0.75	26,9	1.06	24	350	98	1,400	177,8	7.00	0,39	0.26	50 250

Construction

Tube: Nitrile

Reinforcement:
1 textile braid

Cover: Neoprene

Operating parameters

-40°C to +100°C
(-40°F to +212°F)

Application

- General purpose low pressure air, diesel fuel, oil and water lines

For more information on agency listings, specific fluid applications and high temperature ratings see section A.

MSHA Accepted

Fitting reference	Page
Field Attachable	
100 "B" series	I-11

H201

EASY COUPLE general purpose



# Part number	Hose I.D.			Hose O.D.		Maximum operating pressure		Minimum burst pressure		Minimum bend radius		Weight		Vacuum	Package length
	DN	mm	in	mm	in	bar	psi	bar	psi	mm	in	kg/m	lbs/ft	in/Hg	feet
H20104BK H20104BK-250R H20104BK-500R	6	6,4	0.25	13,5	0.53	20,7	300	83	1,200	76,2	3	0,13	0.09	28	50 250 500
H20105GY-250R H20105GY-500R	8	7,9	0.31	15,1	0.59	20,7	300	83	1,200	76,2	3	0,16	0.11	28	250 500
H20106BK H20106BK-250R H20106BK-500R	10	9,5	0.38	17,5	0.69	20,7	300	83	1,200	76,2	3	0,19	0.13	28	50 250 500
H20108BK H20108BK-250R H20108BK-500R	13	12,7	0.50	19,8	0.78	20,7	300	83	1,200	127,0	5	0,22	0.15	28	50 250 500
H20110BK H20110BK-250R	16	15,9	0.63	24,4	0.96	20,7	300	83	1,200	152,4	6	0,34	0.23	28	50 250
H20112BK H20112BK-250R	19	19,0	0.75	27,2	1.07	20,7	300	83	1,200	177,8	7	0,39	0.26	28	50 250
H20116BK H20116BK-250R	25	25,4	1.00	35,4	1.39	13,8	200	55	800	254,0	10	0,57	0.38	18	50 250

Also available in Blue (BU), Red (RD), Green (GN, Gray (GY) and Yellow (YW)

Construction

Tube: Nitrile

Reinforcement:
1 textile braid

Cover: Neoprene (black hose),
vinyl nitrile (colored hose)

Operating parameters

Oil applications:
-40°F to +260°F
(-40°C to +127°C)

Air applications:
-40°F to +212°F
(-40°C to +100°C)

Water applications:
-40°F to +212°F
(-40°C to +100°C)

Application

- General purpose for fuel, lubricating oils, air and water
- Low pressure return lines in hydraulic system

Not recommended for hydraulic impulse applications and not approved for air brake applications.

For more information on agency listings, specific fluid applications and high temperature ratings see section A.

MSHA Accepted

(Black, red, blue, and green)

Fitting reference	Page
Reusable	
100 "B" series	I-11

General purpose

C

H332

General purpose hose



# Part number	Hose I.D.			Hose O.D.		Maximum operating pressure		Minimum burst pressure		Minimum bend radius		Weight		Package length
	DN	mm	in	mm	in	bar	psi	bar	psi	mm	in	kg/m	lbs/ft	feet
H33204-50C H33204-250R	6	6,4	0.25	13,2	0.52	21	305	84	1,220	76,2	3.00	0,12	0.08	50 250
H33206-50C H33206-250R	10	9,5	0.38	16,5	0.65	21	305	84	1,220	76,2	3.00	0,18	0.12	50 250
H33208-50C H33208-250R	13	12,7	0.50	19,8	0.78	21	305	84	1,220	127,0	5.00	0,22	0.15	50 250
H33210-50C H33210-250R	16	15,9	0.63	23,9	0.94	21	305	84	1,220	152,4	6.00	0,31	0.21	50 250
H33212-50C H33212-250R	19	19,0	0.75	26,9	1.06	21	305	84	1,220	177,8	7.00	0,37	0.25	50 250

Construction

Tube: CPE

Reinforcement:

1 textile braid

Cover: Black CPE

Operating parameters

-40°C to +150°C
(-40°F to +302°F)

Air not to exceed +121°C
(+250°F) and water not to exceed +82°C (+180°F).

Application

- General purpose low pressure air, diesel fuel, oil, and water lines

Not recommended for hydraulic impulse applications and not approved for air brake applications

Fitting reference	Page
100 "B" series	I-11

H275

POLYFORCE™ II hose

Air and multipurpose, low working pressure



# Part number	Hose I.D.			Hose O.D.		Max operating pressure (at 70°F)		Max operating pressure (at 150°F)		Minimum burst pressure		Minimum bend radius		Weight		Package length
	DN	mm	in	mm	in	bar	psi	bar	psi	bar	psi	mm	in	kg/m	lbs/ft	
H27504RD H27504RD-600R	6	6,4	0.25	12,7	0.50	17,2	250	3,4	50	69,0	1,000	25,4	1.00	3,2	0.7	50 600
H27506RD H27506RD-600R	10	9,5	0.38	15,9	0.63	17,2	250	3,4	50	69,0	1,000	38,1	1.50	5,4	0.12	50 600
H27508RD H27508RD-500R	13	12,7	0.50	19,1	0.75	17,2	250	3,4	50	69,0	1,000	54,0	2.13	6,8	0.15	50 500
H27510RD-500R	16	15,9	0.625	22,6	0.89	17,2	250	3,4	50	69,0	1,000	—	—	9,5	0.21	500
H27512RD-500R	19	19,1	0.75	26,2	1.03	17,2	250	3,4	50	69,0	1,000	63,5	2.50	10,4	0.23	500
H27516RD-200R	25	25,4	1.00	33,3	1.31	13,8	200	2,8	40	55,2	800	88,9	3.50	15,4	0.34	200
H27520RD-100	32	31,8	1.25	42,9	1.69	13,8	200	2,8	40	55,2	800	—	—	23,6	0.52	100
H27524RD-100	38	38,1	1.50	49,2	1.94	13,8	200	2,8	40	55,2	800	—	—	27,7	0.61	100

Note: Available in other colors on a made to order basis.

Stated working pressures are tested at 68°F. Working pressure decreases as temperature increases.

Construction

Tube: PVC

Reinforcement: Textile:

2 spiral

Cover: PVC/pinpricked

Operating parameters

-23°C to +65°C
(-10°F to +150°F)

Application

- Suitable for transferring air and water

Fitting reference	Page
Crimp	
'E' Series (-06 to -16)	H-2
265 'P' Series (-04 to -12)	H-25
'Z' Series (-04 to -16)	H-29

Industrial hose

Air and multipurpose hose	D-2	Oil and gas exploration	D-7
Chemical hose	D-3	Petroleum	D-7
Food and beverage	D-4	Specialty	D-8
Liquefied petroleum gas	D-5	Steam	D-9
Material handling	D-6	Water	D-10

D

For additional product information please reference Eaton's Industrial Hose Catalog:
North America E-HOOV-MC003-E.



Industrial hose

D

Air and multipurpose

High pressure

H6009 BULLDOG GOLD



EHA500 High pressure air



Low pressure

H9949 SHOCK-SAFE



H1776 & H1777 Perfection 300



H201 EASY COUPLE



H275 Polyforce II



H1812 Industrial Air / Water

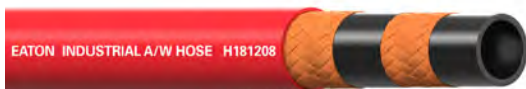

General air and water

H1981 & H1982 Marathoner – Non-conductive



H0106 Bosflex A/W

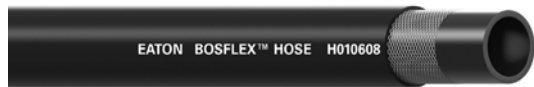

H0105 Bosflex A/W



For additional product information please reference Eaton's Industrial Hose Catalog: North America E-HOOV-MC003-E.

Chemical

Suction and discharge

H0523 CHEMCAT petrochemical



H0599 CHEMCAT corrugated petrochemical



H0554 ARMORCAT petrochemical



H0378 Green cross-linked

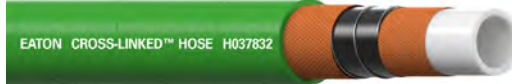

H0345 TIGER chemical suction and discharge



Discharge

H0346 LEOPARD chemical discharge



Specialty

H1941 & H1942 Nyall



For additional product information please reference Eaton's Industrial Hose Catalog: North America E-HOOV-MC003-E.

Industrial hose

D

Food and beverage

Food suction and discharge

H0350 LION Food transfer



Beverage suction and discharge

H285 CLEARFORCE-R



PT200 CLEARFORCE-NR



Cleaning service

H1066 Creamery/Packing washdown

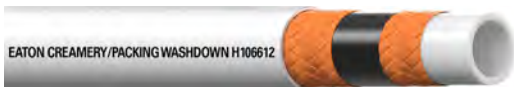

H9673 Washdown 1250

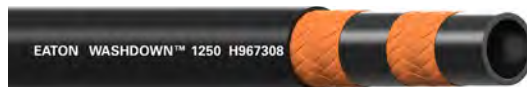

H9610 Washdown 1000



For additional product information please reference Eaton's Industrial Hose Catalog: North America E-HOOV-MC003-E.

Liquefied petroleum gas

LPG

H900

UL LPG



EH920

UL LPG



For additional product information please reference Eaton's Industrial Hose Catalog: North America E-HOOV-MC003-E.

Industrial hose

D

Material handling

Dry material

H0347 WILDCAT dry material



H0319 WILDCAT soft wall dry material



H0521 WILDCAT heavy duty dry material



H0349 WILDCAT hot air transfer



Sandblast

H0034 WILDCAT Sandblast



Concrete Pumping

EHK006 MARAUDER Concrete pumping



EHK007 MARAUDER HD Concrete pumping



For additional product information please reference Eaton's Industrial Hose Catalog: North America E-HOOV-MC003-E.

Oil and gas exploration

Frac and well service

H0377 Kelly power drilling



Suction and discharge

EHP009 Oilfield vacuum



Petroleum

Oil suction and discharge

H6009 BULLDOG GOLD

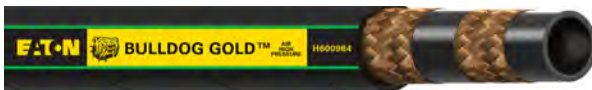

H1193 ROYALFLEX petroleum



H0363 PUMA suction and discharge



EHP150 Petroleum/Oil suction and discharge



Discharge

H901 Boston Bulldog fuel oil delivery



For additional product information please reference Eaton's Industrial Hose Catalog: North America E-HOOV-MC003-E.

Industrial hose

D

Specialty

Road construction

H0372 BLACKCAT hot tar and asphalt



H0616 BLACKCAT corrugated hot tar and asphalt



H9603 Hot tar pumping



Specialized - Refinery hose

H9690 Hydrocarbon drain



H8811 Nitrogen



For additional product information please reference Eaton's Industrial Hose Catalog: North America E-HOOV-MC003-E.

Steam

Steam hose

EH084 Steam Slayer



H9568 Concord 250 steam

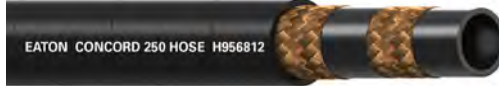

H0084 Concord standard

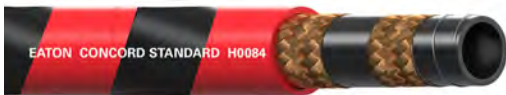

For additional product information please reference Eaton's Industrial Hose Catalog: North America E-HOOV-MC003-E.

Industrial hose

D

Water

Suction and discharge

H1196 Royalflex water



H0364 OTTER water suction and discharge



EHW150 Water suction and discharge



Discharge

EHW029 OTTER layflat water discharge



Specialty

EHW028 Heavy duty MSHA mine spray



H345 Pressure washer

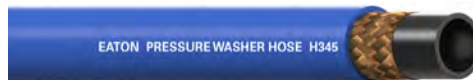

Sewer cleaning

FC701 Eaton GATOR hose



Sewer hoses are only sold as complete assemblies.

FC702 Eaton GATOR hose



Sewer hoses are only sold as complete assemblies.

For additional product information please reference Eaton's Industrial Hose Catalog: North America E-HOOV-MC003-E.

Air conditioning and refrigeration hose

GH001 E-3
H757 E-4
FC800 E-5

E



Air conditioning and refrigeration

E

GH001 EverCool™ A/C and refrigeration E-3



H757 A/C and refrigeration E-4



FC800 EverCool™ A/C and refrigeration E-5



GH001

EverCool™ A/C and refrigeration

Exceeds: SAE J2064 Type E, Class 1



# Part number	Hose I.D.			Hose O.D.		Maximum operating pressure		Minimum burst pressure		Minimum bend radius		Weight		Vacuum service		Available lengths
	DN	mm	in	mm	in	bar	psi	bar	psi	mm	in	kg/m	lbs/ft	kPa	in	
GH001-4WR50 GH001-4WR250	5	5,1	0.20	11,5	0.45	35	500	140	2000	38,1	1.50	0,10	0.07	94,8	28	50 250
GH001-6WR50 GH001-6WR250	8	8,1	0.32	15,2	0.60	35	500	140	2000	50,0	2.00	0,15	0.10	94,8	28	50 250
GH001-8WR50 GH001-8WR250	10	10,7	0.42	18,3	0.72	35	500	140	2000	63,0	2.50	0,21	0.14	94,8	28	50 250
GH001-10WR50 GH001-10WR250	12	13,2	0.52	20,7	0.81	35	500	140	2000	76,2	3.00	0,22	0.15	94,8	28	50 250
GH001-12WR50 GH001-12WR250	16	16,5	0.65	25,1	0.99	35	500	140	2000	101,6	4.00	0,34	0.23	94,8	28	50 250
GH001-16WR50 GH001-16WR250	19	22,9	0.90	31,4	1.24	35	500	140	2000	177,8	7.00	0,37	0.25	94,8	28	50 250

Construction

Tube: New dual extrusion technology polyamide Type E veneer

Reinforcement: Textile braid

Cover: Blended EPDM

Operating parameters

-40°C to +140°C
(-40°F to +284°F)

R1234yf effusion
.3 kg/m²/yr at 80°C

R134a effusion
.5 kg/m²/yr at 80°C

Oils

POE, PAG, Mineral oil, Alkybenzene

Moisture ingress

<0.039 g/cm²/year according to SAE J2064, Class 1

Benefits

- Extremely low permeation
- Excellent heat resistance offering a higher functional temperature range than SAE J2064 Type C or E hoses.
- Ozone and UV resistant
- Easy to install – significant reduction in potential hose damage. GH001 has maximum kink resistance, temperature resistance
- SAE J2064 Type E veneer tube offers excellent oil and refrigerant compatibility

Application

- A/C systems for truck, bus, agriculture, construction equipment and refrigeration systems

For more information refer to E-HOAC-BB001-E Eaton GH001 Evercool A/C hose.

Fitting reference

Factory Crimp – For more information, please contact Eaton Customer Service at 952-937-9800.

E-Z Clip fittings – refer to Field Attachable section, page I-31.

H757

Air conditioning hose

Exceeds: SAE J2064 Type C Class 1



# Part number	Hose I.D.		Hose O.D.		Maximum operating pressure		Minimum burst pressure		Minimum bend radius		Weight		Avail. lengths	
	DN	mm	in	mm	in	bar	psi	bar	psi	mm	in	kg/m		lbs/ft
H75706 H75706-100 H75706-250	8	8,1	0.32	15,2	0.60	27,6	400	137,9	2,000	50,8	2.00	0,14	0.09	50 100 250
H75708 H75708-100 H75708-250	10	10,7	0.42	17,8	0.70	27,6	400	137,9	2,000	63,5	2.50	0,17	0.12	50 100 250
H75710 H75710-100 H75710-250	13	13,2	0.52	19,9	0.79	24,1	350	120,7	1,750	76,2	3.00	0,19	0.13	50 100 250
H75712 H75712-100 H75712-250	16	16,3	0.64	24,1	0.95	24,1	350	120,7	1,750	101,6	4.00	0,34	0.23	50 100 250

Construction

Tube: Rubber

Barrier: Nylon

Reinforcement:
1 textile braid

Cover: Butyl (perforated)

Operating parameters

-30°C to +120°C
(-22°F to +248°F) for R12;

-30°C to +125°C
(-22°F to +257°F) for R134a

Application

- A refrigerant hose recommended for R134a and R12 applications
- Ideal for heavy duty truck use as well as industrial and automotive applications

Fitting reference	Page
Crimp 757 "E" series	H-15

FC800

EverCool™ A/C hose

Meets: SAE J2064



# Part number	Hose I.D.		Hose O.D.		Maximum operating pressure		Minimum burst pressure		Minimum bend radius		Weight		Vacuum service		
	DN	mm	in	mm	in	bar	psi	bar	psi	mm	in	kg/m	lbs/ft	kPa	in
FC800-12	16	16,4	0.65	27,2	1.07	35	500	140	2,000	70	2.8	0,67	0.45	94,8	28
FC800-16	19	22,8	0.90	31,5	1.24	35	500	140	2,000	80	3.2	0,71	0.48	94,8	28
FC800-20	25	29,3	1.15	38,6	1.52	35	500	140	2,000	100	3.9	0,92	0.62	94,8	28
FC800-24	31	35,5	1.40	45,6	1.80	35	500	140	2,000	160	6.3	1,16	0.78	94,8	28

Construction

Tube: Chloroprene (CR)

Barrier Layer:
Polyamide (PA)

Reinforcement:
1 wire braid

Cover: EPDM

Operating parameters

-40°C to +125°C
(-40°F to +257°F)

Permeation rate
<1,0 kg/m²/year
(for R134a at 80°C)

Moisture ingress
<0.039 g/cm²/year
according to SAE J2064,
Class 1

Refrigerant use
R134a, R407C, HF1234yf.
Additional refrigerants and
refrigerant oils upon request.

Benefits

- FC800 EverCool exceeds the requirements of the SAE J2064
- FC800 has an excellent bend radius, virtually 1/2 of the radius of comparable large bore hoses

Applications

- Metro, large bus and rail
- Overhead cranes and stationary equipment

For more information refer to A-HOAC-MR003-E, EverCool New Large Bore A/C Hose.

Fitting reference	Page
FC800 A/C	I-28

Transportation

Synflex coils, air brake and diesel fuel tubing

15CA Eclipse	F-5
3SCE Eclipse	F-5
4245 Eclipse	F-6
4247 Solstice	F-7
3270 Eclipse	F-8

Synflex diesel fuel tubing

4294 Synflex	F-9
4297 Synflex	F-10
4KGEN Synflex	F-11

Engine and air brake hose

EC038	F-12
H069	F-13
H166	F-14
H169	F-15
H213	F-16
H229	F-17
H239	F-18
H429	F-18
H569	F-19

Diesel and biodiesel hose

GH100 ESP	F-20
GH101 ESP	F-21

F

Fuel line hose

H057	F-22
H059	F-23
35FH	F-23

Silicone hose

EH225	F-24
EH226	F-25
EH227	F-26

Power steering

H324	F-27
------------	-------------

LPG hose

H366	F-28
H900 Black Line	F-28

CNG hose

NG-TW	F-29
35NG Synflex	F-30



Air brake coils, and air brake tubing

15CA Eclipse air brake coil **F-5**



3SCE Eclipse fifth-wheel slider coil **F-5**



4245 Eclipse truck air brake, Type A **F-6**



4247 Solstice truck air brake, Type A **F-7**



3270 Eclipse truck air brake, Type B **F-8**



Synflex diesel fuel tubing

4294 Low-flex diesel fuel tubing **F-9**



4297 High-flex diesel fuel tubing **F-10**

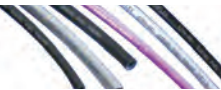

4KGEN Diesel fuel kits **F-11**

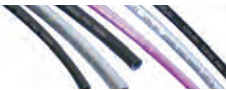

Air brake hose

EC038 Air brake hose **F-12**



Engine and air brake hose

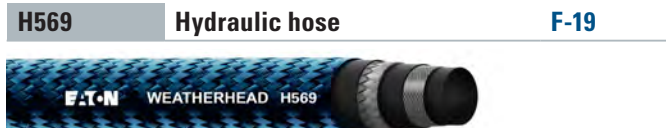
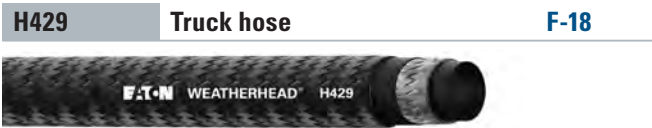
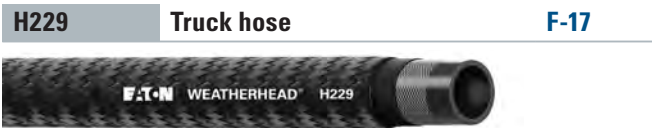
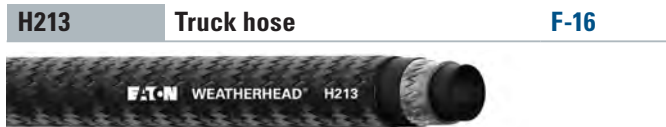
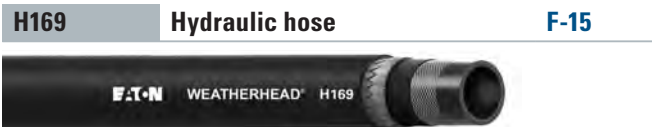
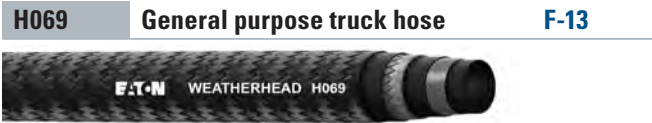

Diesel and biodiesel hose



Fuel line hose

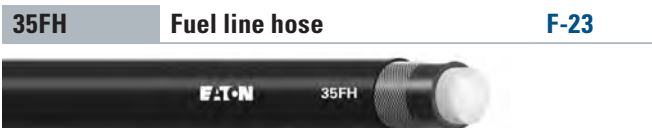
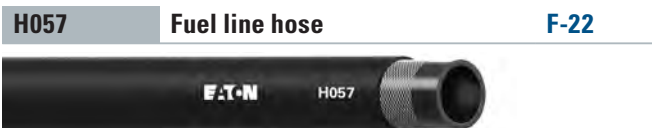

Silicone hose

EH225 Heater hose **F-24**

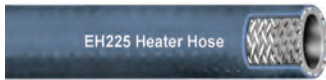

EH226 Coolant hose **F-25**



EH227 4-ply Turbo hose **F-26**



Power steering

H324 Power steering hose **F-27**



LPG hose

H366 LPG **F-28**



H900 LPG **F-28**



CNG hose

NG-TW Low pressure CNG hose **F-29**



35NG High pressure CNG hose **F-30**



15CA Eclipse Air brake coil

Meets: SAE J844 Type B, DOT-FMVSS 106, (49 FR571.106)



# Part number	Description	Valve pigtail length		Male ends				Working Length	
		mm	in	Valve		Gladhand		m	ft
				mm	in	mm	in		
15CA12-12	15' WL abt coil set w/ 12" pigtails	304,8	12.00	12,7	0.50	12,7	0.50	4,6	15.00
15CA48-12	15' WL abt coil set w/ 48" pigtails	1.219,2	48.00	12,7	0.50	12,7	0.50	4,6	15.00
15CAR12-12	15' WL single, red abt coil w/ 12" pigtails	304,8	12.00	12,7	0.50	12,7	0.50	4,6	15.00
15CAB12-12	15' WL single, blue abt coil w/ 12" pigtails	304,8	12.00	12,7	0.50	12,7	0.50	4,6	15.00
15CAR48-12	15' WL single, red abt coil w/ 48" pigtails	1.219,2	48.00	12,7	0.50	12,7	0.50	4,6	15.00
15CAB48-12	15' WL single, blue abt coil w/ 48" pigtails	1.219,2	48.00	12,7	0.50	12,7	0.50	4,6	15.00
12CA12-12	12' WL abt coils set w/ 12" pigtails	304,8	12.00	12,7	0.50	12,7	0.50	3,7	17.00
12CAR12-12	12' WL single, red abt coil w/ 12" pigtails	304,8	12.00	12,7	0.50	12,7	0.50	3,7	17.00
12CAB12-12	12' WL single, blue abt coil w/ 12" pigtails	304,8	12.00	12,7	0.50	12,7	0.50	3,7	17.00
20CA12-12	20' WL abt coil set w/ 12" pigtails	304,8	12.00	12,7	0.50	12,7	0.50	6,1	20.00

Construction

Tube: Synflex Eclipse air brake tubing, 100% polyamide

Reinforcement:
Polyester yarn

Brass end fittings with corrosion resistant spring guards

Operating parameters

-54°C to +93°C
(-65°F to +200°F)

Application

- Articulating connections for air brake line systems (connections between towed and towing motor vehicle)
- Tractor-to-trailer air connections used in extremely low temperatures

Features

- Superior abrasion resistance
- Excellent return and coil memory
- Enhanced flexibility and extension
- Brass end fittings with corrosion resistant spring guards

3SCE Eclipse Fifth-wheel slider coil

Meets: SAE J844 Type B, DOT-FMVSS 106, (49 FR571.106)



# Part number	Valve pigtail length		End fitting	Working length		Retracted length	
	mm	in		mm	ft	mm	in
3SCE-0303304-033	88,9	3.50	None	1.371,6	54.00	254,0	10.00
3SCE-0303304-166	88,9	3.50	1/4" male pipe	1.371,6	54.00	254,0	10.00

Construction

Tube: Synflex Eclipse air brake tubing, 100% polyamide

Reinforcement:
Polyester yarn

Brass end fittings with corrosion resistant spring guards

Operating parameters

-54°C to +93°C
(-65°F to +200°F)

Application

- Articulating connections for air brake line systems (connections between towed and towing motor vehicle)
- Tractor-to-trailer air connections used in extremely low temperatures

Features

- Superior abrasion resistance
- Excellent return and coil memory
- Enhanced flexibility and extension

Transportation

Synflex coils and air brake tubing

F

4245 Eclipse

Type A truck air brake tubing

Meets: SAE J844 Type A, SAE J1131, SAE J2494-3, DOT-FMVSS 106



# Part number	Tube size	Tube O.D.		Tube I.D.		Wall thickness		Minimum burst pressure		Minimum bend radius		Weight		Color	Package length*	
		mm	in	mm	in	mm	in	bar	psi	mm	in	kg/100m	lbs/100ft		m	ft
		4245-02207	-02	3,2	.125	2,0	0.08	0,6	0.02	69,0	1,000	6,4	0.25		0,5	0.33
4245-02227	-02	3,2	.125	2,0	0.08	0,6	0.02	69,0	1,000	6,4	0.25	0,5	0.33	Red	3.657,6	12,000
4245-02257	-02	3,2	.125	2,0	0.08	0,6	0.02	69,0	1,000	6,4	0.25	0,5	0.33	Green	3.657,6	12,000
4245-02267	-02	3,2	.125	2,0	0.08	0,6	0.02	69,0	1,000	6,4	0.25	0,5	0.33	Blue	3.657,6	12,000
4245-02506	-02	4,0	.125	2,3	0.09	0,8	0.03	83,0	1,200	12,7	0.50	0,8	0.56	Black	1.828,8	6,000
4245-02526	-02	4,0	.125	2,3	0.09	0,8	0.03	83,0	1,200	12,7	0.50	0,8	0.56	Red	1.828,8	6,000
4245-02546	-02	4,0	.125	2,3	0.09	0,8	0.03	83,0	1,200	12,7	0.50	0,8	0.56	Yellow	1.828,8	6,000
4245-02556	-02	4,0	.125	2,3	0.09	0,8	0.03	83,0	1,200	12,7	0.50	0,8	0.56	Green	1.828,8	6,000
4245-02566	-02	4,0	.125	2,3	0.09	0,8	0.03	83,0	1,200	12,7	0.50	0,8	0.56	Blue	1.828,8	6,000
4245-03306	-03	4,8	.188	3,0	0.12	0,9	0.04	83,0	1,200	19,1	0.75	1,1	0.71	Black	1.828,8	6,000
4245-03326	-03	4,8	.188	3,0	0.12	0,9	0.04	83,0	1,200	19,1	0.75	1,1	0.71	Red	1.828,8	6,000
4245-03356	-03	4,8	.188	3,0	0.12	0,9	0.04	83,0	1,200	19,1	0.75	1,1	0.71	Green	1.828,8	6,000

*Master pack quantity part numbers listed. For master pack configuration information refer to chart below:

Construction

Tube: 100% polyamide

Reinforcement:

Polyester yarn

Operating parameters

-54°C to +93°C
(-65°F to +200°F)

Application

- Truck air brake systems
- Trailer air brake systems
- Auxiliary air systems
- Formed tubes
- Formed and straight air brake harness assemblies

Not for use with fuel.

Features

- Superior abrasion resistance
- Ease of cutting
- Enhanced flexibility and extension
- Flow performance
- UV stabilized, thermoformable
- Available in standard and custom colors
- Available in all standard sizes

Fitting reference

Brass

For more information on brass fittings see Eaton Brass Products Master Catalog E-BRFI-MC001-E.

Master pack configuration

Part number	Hose I.D.		Package type	Package count	Package Length	
	mm	in			mm	ft
4245-02	2,0	0.08	Reel	6	609,6	2,000
4245-02	2,3	0.09	Reel	6	304,8	1,000
4245-03	3,0	0.12	Reel	6	304,8	1,000
4247-04	4,3	0.17	Reel	6	304,8	1,000
4245-05	5,9	0.23	Reel	6	152,4	500

Note: Eaton offers 100, 500, and 1,000 ft short roll packages for the 4245 and 4247 tubing. Please see Eaton literature E-PNOV-MS004-E Short Roll Reference Guide, for details or contact your Eaton sales or customer service representative.



4247 Solstice Type A truck air brake tubing

Meets: SAE J844 Type A, SAE J1131, SAE J2494-3, DOT-FMVSS 106

# Part number	Tube size	Tube O.D.		Tube I.D.		Wall thickness		Minimum burst pressure		Minimum bend radius		Weight		Color	Package length*	
		mm	in	mm	in	mm	in	bar	psi	mm	in	kg/100m	lbs/100ft		m	ft
		4247-04106	-04	6,4	.25	4,3	0.17	1,0	0.04	83,0	1,200	25,4	1.00		2,2	1.50
4247-04126	-04	6,4	.25	4,3	0.17	1,0	0.04	83,0	1,200	25,4	1.00	2,2	1.50	Red	1.828,8	6,000
4247-04136	-04	6,4	.25	4,3	0.17	1,0	0.04	83,0	1,200	25,4	1.00	2,2	1.50	Orange	1.828,8	6,000
4247-04146	-04	6,4	.25	4,3	0.17	1,0	0.04	83,0	1,200	25,4	1.00	2,2	1.50	Yellow	1.828,8	6,000
4247-04156	-04	6,4	.25	4,3	0.17	1,0	0.04	83,0	1,200	25,4	1.00	2,2	1.50	Green	1.828,8	6,000
4247-04166	-04	6,4	.25	4,3	0.17	1,0	0.04	83,0	1,200	25,4	1.00	2,2	1.50	Blue	1.828,8	6,000
4245-05204	-05	8,0	.312	5,9	0.23	1,0	0.04	69,0	1,000	28,6	1.13	2,3	1.54	Black	914,4	3,000
4245-05224	-05	8,0	.312	5,9	0.23	1,0	0.04	69,0	1,000	28,6	1.13	2,3	1.54	Red	914,4	3,000
4245-05244	-05	8,0	.312	5,9	0.23	1,0	0.04	69,0	1,000	28,6	1.13	2,3	1.54	Yellow	914,4	3,000
4245-05254	-05	8,0	.312	5,9	0.23	1,0	0.04	69,0	1,000	28,6	1.13	2,3	1.54	Green	914,4	3,000
4245-05264	-05	8,0	.312	5,9	0.23	1,0	0.04	69,0	1,000	28,6	1.13	2,3	1.54	Blue	914,4	3,000

*Master pack quantity part numbers listed. For master pack configuration information refer to chart below:

Construction

Tube: 100% polyamide

Reinforcement:
Polyester yarn

Operating parameters

-54°C to +93°C
(-65°F to +200°F)

Application

- Truck air brake systems
- Trailer air brake systems
- Auxiliary air systems
- Formed tubes
- Formed and straight air brake harness assemblies

Not for use with fuel.

Features

- Superior abrasion resistance
- Ease of cutting
- Enhanced flexibility and extension
- Flow performance
- UV stabilized, thermoformable
- Available in standard and custom colors
- Available in all standard sizes

Fitting reference

Brass

For more information on brass fittings see Eaton Brass Products Master Catalog E-BRFI-MC001-E.

Master pack configuration

Part number	Hose I.D.		Package type	Package count	Package Length	
	mm	in			mm	ft
4245-02	2,0	0.08	Reel	6	609,6	2,000
4245-02	2,3	0.09	Reel	6	304,8	1,000
4245-03	3,0	0.12	Reel	6	304,8	1,000
4247-04	4,3	0.17	Reel	6	304,8	1,000
4245-05	5,9	0.23	Reel	6	152,4	500

Note: Eaton offers 100, 500, and 1,000 ft short roll packages for the 4245 and 4247 tubing. Please see Eaton literature E-PNOV-MS004-E Short Roll Reference Guide, for details or contact your Eaton sales or customer service representative.

Transportation

Synflex coils and air brake tubing

F

3270 Eclipse

Type B truck air brake tubing

Meets: SAE J844 Type B, SAE J1131, SAE J2494-3, DOT-FMVSS 106



# Part number	Tube size	Tube O.D.		Tube I.D.		Wall thickness		Minimum burst pressure		Minimum bend radius		Weight		Color	Package length*	
		mm	in	mm	in	mm	in	bar	psi	mm	in	kg/100m	lbs/100ft		m	ft
3270-06104	-06	9,5	.375	6,4	0.25	1,6	0.06	96,5	1,400	38,1	1.50	4,2	2.80	Black	914,4	3,000
3270-06124	-06	9,5	.375	6,4	0.25	1,6	0.06	96,5	1,400	38,1	1.50	4,2	2.80	Red	914,4	3,000
3270-06134	-06	9,5	.375	6,4	0.25	1,6	0.06	96,5	1,400	38,1	1.50	4,2	2.80	Orange	914,4	3,000
3270-06144	-06	9,5	.375	6,4	0.25	1,6	0.06	96,5	1,400	38,1	1.50	4,2	2.80	Yellow	914,4	3,000
3270-06154	-06	9,5	.375	6,4	0.25	1,6	0.06	96,5	1,400	38,1	1.50	4,2	2.80	Green	914,4	3,000
3270-06164	-06	9,5	.375	6,4	0.25	1,6	0.06	96,5	1,400	38,1	1.50	4,2	2.80	Blue	914,4	3,000
3270-08104	-08	12,7	.50	9,6	0.38	1,6	0.06	65,5	950	50,8	2.00	5,8	3.80	Black	457,2	1,500
3270-08124	-08	12,7	.50	9,6	0.38	1,6	0.06	65,5	950	50,8	2.00	5,8	3.80	Red	457,2	1,500
3270-08134	-08	12,7	.50	9,6	0.38	1,6	0.06	65,5	950	50,8	2.00	5,8	3.80	Orange	457,2	1,500
3270-08144	-08	12,7	.50	9,6	0.38	1,6	0.06	65,5	950	50,8	2.00	5,8	3.80	Yellow	457,2	1,500
3270-08154	-08	12,7	.50	9,6	0.38	1,6	0.06	65,5	950	50,8	2.00	5,8	3.80	Green	457,2	1,500
3270-08164	-08	12,7	.50	9,6	0.38	1,6	0.06	65,5	950	50,8	2.00	5,8	3.80	Blue	457,2	1,500
3270-10103	-10	15,9	.625	11,2	0.44	2,3	0.09	62,1	900	63,5	2.50	10,4	7.00	Black	228,6	750
3270-10123	-10	15,9	.625	11,2	0.44	2,3	0.09	62,1	900	63,5	2.50	10,4	7.00	Red	228,6	750
3270-10133	-10	15,9	.625	11,2	0.44	2,3	0.09	62,1	900	63,5	2.50	10,4	7.00	Orange	228,6	750
3270-10143	-10	15,9	.625	11,2	0.44	2,3	0.09	62,1	900	63,5	2.50	10,4	7.00	Yellow	228,6	750
3270-10153	-10	15,9	.625	11,2	0.44	2,3	0.09	62,1	900	63,5	2.50	10,4	7.00	Green	228,6	750
3270-10163	-10	15,9	.625	11,2	0.44	2,3	0.09	62,1	900	63,5	2.50	10,4	7.00	Blue	228,6	750
3270-12103	-12	19,1	.75	14,4	0.57	2,3	0.09	55,2	800	76,2	3.00	12,8	8.60	Black	228,6	750
3270-12123	-12	19,1	.75	14,4	0.57	2,3	0.09	55,2	800	76,2	3.00	12,8	8.60	Red	228,6	750
3270-12133	-12	19,1	.75	14,4	0.57	2,3	0.09	55,2	800	76,2	3.00	12,8	8.60	Orange	228,6	750
3270-12153	-12	19,1	.75	14,4	0.57	2,3	0.09	55,2	800	76,2	3.00	12,8	8.60	Green	228,6	750
3270-12163	-12	19,1	.75	14,4	0.57	2,3	0.09	55,2	800	76,2	3.00	12,8	8.60	Blue	228,6	750

*Master pack quantity part numbers listed. For master pack configuration information refer to chart below.

Construction

Tube: 100% polyamide formed tubes

Reinforcement: Polyester yarn

Operating parameters

-54°C to +93°C
(-65°F to +200°F)

Application

- Truck air brake systems
- Trailer air brake systems
- Auxiliary air systems

Not for use with fuel.

Features

- Superior abrasion resistance
- Ease of cutting
- Enhanced flexibility and extension
- Flow performance
- UV stabilized, thermoformable
- Formed and straight air brake harness assemblies
- Available in standard and custom colors
- Available in all standard sizes

Master pack configuration

Part number	Hose I.D.		Package type	Package count	Package Length	
	mm	in			mm	ft
3270-06	6,4	0.25	Reel	6	152,4	500
3270-08	9,6	0.38	Reel	3	152,4	500
3270-10	11,2	0.44	Reel	3	76,2	250
3270-12	14,4	0.57	Reel	3	76,2	250

Note: Eaton offers 100, 500, and 1,000 ft short roll packages for the 3270 tube. Please see Eaton literature E-PNOV-MS004-E for details or contact your Eaton sales or customer service representative.



4294 Synflex Low-flex diesel fuel tubing

# Part number	Tube size	Tube I.D.		Tube O.D.		Wall thickness		Maximum operating pressure		Minimum burst pressure		Minimum bend radius		Weight		Color	Package length*	
		DN	mm in	mm in	mm in	mm in	bar psi	bar psi	mm in	mm in	kg/100m	lbs/100ft	m	ft				
4294-06	-06	10	6,4 0.25	9,9 0.40	1,8 0.07	5 75	34,5 500	28,7 1.13	1,4 3.00	Black Aluminum	30,5 100							
4294-07	-07	11	7,6 0.30	11,1 0.44	1,8 0.07	5 75	34,5 500	31,8 1.25	1,5 3.40	Black Aluminum	30,5 100							
4294-08	-08	12	9,5 0.38	13,3 0.53	1,9 0.08	5 75	34,5 500	76,3 3.00	2,0 4.50	Black Aluminum Purple	30,5 100							
4294-10	-10	16	12,1 0.48	17,2 0.68	2,5 0.10	5 75	34,5 500	88,9 3.50	3,3 7.30	Black Aluminum	30,5 100							

*Random length box packaged part numbers listed. Other packaging options available. See Customer Connect or contact your Eaton customer service representative.

Construction

Tube: Nylon 12

Cover: Thermoplastic

Operating parameters

-40°C to +93°C
(-40°F to +200°F)

Standard Compliance

Portions of: SAE J844,
J1131, J1394

ASTM D471, 0624, 0638,
D648, 0709, 0746, 0742,
02240

Application

- Designed specifically for diesel fuel applications
- Transportation – trucks, buses and off-highway vehicles, construction machinery and equipment
- Agriculture machinery and equipment
- Marine, boats and yachts
- Diesel engines and generators

Features

- Lightweight fuel tube assemblies can weigh up to 66% less
- Well suited for formed fuel harness applications
- Multiple color options
- Excellent cost/value

Qualified fittings

Contact your Eaton account sales manager for composite and metal fitting options.

For more information refer to the Synflex Thermoplastic Hose and Fittings E-HOOV-MC001-E.

Transportation

Synflex diesel fuel tubing

F

4297 Synflex

High-flex diesel fuel tubing



# Part number	Hose size	Tube I.D.		Tube O.D.		Wall thickness		Maximum operating pressure		Minimum burst pressure		Minimum bend radius		Weight		Color	Package length*	
		DN	mm in	mm in	mm in	mm in	bar psi	bar psi	mm in	mm in	kg/100m	lbs/100ft	m	ft				
4297-M10	M10	10	6,0 0.24	9,6 0.39	1,9 0.08	4 50	34,0 500	28,7 1.13	1,4 3.10	Black	30,5 100							
4297-06	-06	10	6,4 0.25	9,9 0.39	1,9 0.07	4 50	34,0 500	28,7 1.13	1,4 3.10	Black Aluminum	30,5 100							
4297-07	-07	11	7,6 0.30	11,1 0.44	1,9 0.07	4 50	34,0 500	31,8 1.25	1,6 3.50	Black Aluminum	30,5 100							
4297-M12	M12	12	8,0 0.31	11,8 0.48	1,9 0.08	4 50	34,0 500	44,5 1.75	1,7 3.70	Black	30,5 100							
4297-08	-08	12	9,5 0.38	13,3 0.53	1,9 0.07	4 50	34,0 500	76,3 3.00	2,2 4.90	Black Aluminum	30,5 100							
4297-10	-10	16	12,1 0.48	17,2 0.68	2,5 0.10	4 50	34,0 500	88,9 3.50	3,4 7.40	Black Aluminum	30,5 100							

*Random length box packaged part numbers listed. Other packaging options available. See Customer Connect or contact your Eaton customer service representative.

Construction

Tube: Nylon 11

Cover: Thermoplastic elastomer

Operating parameters

-45°C to +122°C
(-50°F to +250°F)

Standard Compliance

Portions of: SAE J844, J1131, J1394

ASTM D471, 0624, 0638, D648, 0709, 0746, 0742, 02240

Application

- Formed or unformed harnesses
- Transportation – trucks, buses and off-highway vehicles
- Construction machinery and equipment
- Agriculture machinery and equipment
- Marine, boats and yachts
- Diesel engines and generators

Features

- Excellent flexibility
- Well suited for individual line installation
- Multiple colors
- Designed specifically for diesel fuel applications
- Lightweight fuel tube assemblies can weigh up to 66% less
- Excellent cost/value

Qualified fittings

Contact your Eaton account sales manager for composite and metal fitting options.

For more information refer to the Synflex Thermoplastic Hose and Fittings E-HOOV-MC001-E.



4KGEN Synflex

Diesel fuel kits

Specifically designed for modification or repair of OEM fuel systems that use Synflex 4294 or 4297 series fuel tubing.

4KGEN-08-001 Fuel tubing extension kit

Part number	Hose size	DN	Description	Qty	Unit of measure
4408-08710*	-08	12	Plastic female fitting	4	Pieces
4408-08610*	-08	12	Plastic 90° fitting	2	Pieces
4408-08310*	-08	12	Plastic straight fitting	2	Pieces
4294-0810K	-08	12	Black fuel tubing	25	Feet
4294-081FK	-08	12	Silver fuel tubing	25	Feet

* MTO

4KGEN-10-001 Fuel tubing extension kit

Part number	Hose size	DN	Description	Qty	Unit of measure
4408-10710*	-10	16	Brass female fitting	4	Pieces
4408-10610	-10	16	Plastic 90° fitting	2	Pieces
4408-10310*	-10	16	Plastic straight fitting	2	Pieces
4297-101FX-001	-10	16	Silver fuel tubing	25	Feet

* MTO

Kit content

- OEM male, female, straight and 90 degree barbed fittings
- Synflex 4294 or 4297 series tubing

Application

- Transportation – trucks, buses, off-highway vehicles
- Construction machinery and equipment
- Agriculture machinery and equipment
- Diesel engines and parts

Features

- Synflex 4KGEN kits can be used to modify tank locations, routings, and repair fuel systems in these and many other applications where diesel fuel is used
- Utilize OEM barbed end fittings to maintain O-Ring sealing end connection of the original OEM fuel system
- OEM colors available to maintain the same OEM color code integrity

For more information refer to the Synflex Thermoplastic Hose and Fittings E-HOOV-MC001-E.

Transportation

Air brake hose

F

EC038

Air brake hose

Meets: SAE J1402, DOT/FMVSS 106 Type All



# Part number	Hose I.D.		Hose O.D.		Maximum operating pressure		Minimum burst pressure		Minimum bend radius		Vacuum service		Weight		Avail. length
	DN	mm in	mm in	bar psi	bar psi	mm in	kPa in	kg/m lbs/ft	feet						
EC03804-250R	6	6,4 0.25	16,7 0.66	15,0 225	62,0 900	32,0 1.25	94,8 28	0,22 0.15	250						
EC03806-250R	10	9,5 0.38	19,8 0.78	15,0 225	62,0 900	45,0 1.75	94,8 28	0,31 0.21	250						
EC03808-250R	12	12,7 0.50	23,0 0.91	15,0 225	62,0 900	51,0 2.00	94,8 28	0,40 0.27	250						

Construction

Tube: Highly engineered EPDM

Reinforcement: Textile braid

Cover: EPDM

Operating parameters

-40°C to +212°C
(-40°F to +100°F)

Application

- Tractor to trailer lines, axle chamber lines and tractor service lines

Fitting reference	Page
Crimp	
338 "P" series (-6 & -8 only)	H-26
Field Attachable	
338 "B" series (-6 & -8 only)	I-15

H069

General purpose truck hose

Meets: SAE 100R5, SAEJ1402 Type II, DOT All†, ABS



# Part number	Hose I.D.			Hose O.D.		Maximum operating pressure		Minimum burst pressure		Minimum bend radius		Weight		Avail. lengths
	DN	mm	in	mm	in	bar	psi	bar	psi	mm	in	kg/m	lbs/ft	feet
H06904 H06904-250R	5	4,8	0.19	13,7	0.54	210	3,000	840	12,000	75	2.95	0,24	0.16	50 250
H06905 H06905-250R	6	6,4	0.25	15,2	0.60	210	3,000	840	12,000	85	3.35	0,33	0.22	50 250
H06906 H06906-250R	8	7,9	0.31	17,8	0.70	157	2,250	630	9,000	100	3.94	0,36	0.24	50 250
H06908 H06908-250R	10	10,3	0.41	20,1	0.79	140	2,000	560	8,000	115	4.53	0,43	0.29	50 250
H06910 H06910-250R	12	12,7	0.50	23,9	0.94	122	1,750	490	7,000	140	5.51	0,54	0.36	50 250
H06912 H06912-250R	16	15,9	0.62	27,9	1.10	105	1,500	420	6,000	165	6.50	0,65	0.44	50 250
H06916 H06916-250R	22	22,2	0.88	32,3	1.27	56	800	224	3,200	185	7.28	0,68	0.46	50 250
H06920 H06920-150	29	28,6	1.12	38,9	1.53	43	625	175	2,500	230	9.06	0,76	0.51	50 150
H06924 H06924-100	35	34,9	1.38	44,8	1.76	35	500	140	2,000	265	10.43	0,85	0.57	50 100
H06932 H06932-100	46	46,0	1.81	57,5	2.26	24	350	98	1,400	335	13.19	1,24	0.83	50 100
H06940	60	60,3	2.38	74,2	2.92	24	350	98	1,400	610	24.00	2,14	1.44	50

† Sizes -4 thru -12 only.

Construction

Tube: Nitrile

Reinforcement:

1 textile braid,
1 single wire braid

Cover: Textile braid

Operating parameters

Hydraulic:
-40°C to +100°C
(-40°F to +212°F)

Air brake:
-40°C to +93°C
(-40°F to +200°F)

Hot oil:
-40°C to +121°C
(-40°F to +250°F)

Application

- General purpose truck and hydraulic hose
- For use in air brake, fuel, grease lines, high temperature petroleum oils and medium pressure hydraulic applications
- -16 thru -40 sizes are not SAE or DOT approved for air brake applications

For more information on agency listings, specific fluid applications and high temperature ratings see section A.

Fitting reference	Page
Crimp	
069 "E" series (except -40 size)	H-9
Field Attachable	
069 "D" series	I-18
247 "N" series (-4 to -16)	I-23

Transportation

Engine and air brake

F

H166 Truck hose

Meets: SAE J1402 TYPE AII, DOT AII



# Part number	Hose I.D.			Hose O.D.		Maximum operating pressure		Minimum burst pressure		Minimum bend radius		Weight		Avail. lengths
	DN	mm	in	mm	in	bar	psi	bar	psi	mm	in	kg/m	lbs/ft	feet
H16604	5	4,8	0.19	13,7	0.54	105	1,500	420	6,000	38,1	1.50	0,18	0.12	50
H16605	6	6,4	0.25	15,2	0.60	35	500	140	2,000	43,9	1.73	0,21	0.14	50
H16606	8	7,9	0.31	17,8	0.70	35	500	140	2,000	50,8	2.00	0,27	0.18	50
H16608	10	10,3	0.41	20,1	0.79	35	500	140	2,000	58,9	2.32	0,31	0.21	50
H16610	12	12,7	0.50	24,1	0.95	31	450	126	1,800	69,8	2.75	0,43	0.29	50
H16612	16	15,9	0.62	27,9	1.10	31	450	126	1,800	82,8	3.26	0,55	0.37	50
H16616*	22	22,2	0.88	32,0	1.26	17	250	70	1,000	101,6	4.00	0,57	0.38	50
H16620*	29	28,6	1.12	38,5	1.51	17	250	70	1,000	140,0	5.51	0,68	0.46	50

* 16 and 20 sizes not SAE or DOT approved for air brake applications.

Construction

Tube: Nitrile

Reinforcement: 1 textile braid, 1 stainless steel braid

Cover: Textile braid

Operating parameters

Hydraulic:
-40°C to +121°C
(-40°F to +250°F)

Air brake:
-40°C to +93°C
(-40°F to +200°F)

Application

- General purpose truck and hydraulic hose.
- For use in air brake, fuel, diesel fuel, high temperature petroleum oil applications
- -16 thru -40 sizes are not SAE or DOT approved for air brake applications

For more information on agency listings, specific fluid applications and high temperature ratings see section A.

Fitting reference	Page
Crimp	
069 "E" series	H-9
Field Attachable	
069 "D" series	I-18
247 "N" series (except -20 size)	I-23

H169
Hydraulic hose



# Part number	Hose I.D.		Hose O.D.		Maximum operating pressure		Minimum burst pressure		Minimum bend radius		Weight		Avail. lengths
	DN	mm in	mm in	bar psi	bar psi	mm in	kg/m lbs/ft	feet					
H16906 H16906-250R	8	7,9 0.31	17,5 0.69	155 2,250	620 9,000	102 4.00	0.36 0.24	50 250					
H16908 H16908-250R	10	10,3 0.41	19,6 0.77	138 2,000	552 8,000	117 4.62	0.40 0.27	50 250					
H16910	12	12,7 0.50	23,9 0.94	120 1,750	480 7,000	140 5.50	0.57 0.38	50					
H16912	16	15,9 0.62	28,2 1.11	103 1,500	412 6,000	165 6.50	0.70 0.47	50					
H16916	22	22,2 0.88	32,3 1.27	55 800	220 3,200	187 7.38	0.65 0.44	50					
H16920	29	28,6 1.12	38,9 1.53	43 625	172 2,500	229 9.00	0.76 0.51	50					
H16924	35	34,9 1.38	45,2 1.78	35 500	140 2,000	267 10.50	1.01 0.68	50					
H16932	46	46,0 1.81	57,4 2.26	24 350	96 1,400	337 13.25	1.31 0.88	50					

Construction

Tube: Nitrile

Reinforcement:

1 textile braid,
1 single wire braid

Cover: Neoprene

Operating parameters

-40°C to +100°C

(-40°F to +212°F)

Application

- Medium pressure hydraulic, air, grease, oil, truck and power steering lines.

For more information on agency listings, specific fluid applications and high temperature ratings see section A.

Fitting reference	Page
Crimp	
069 "E" series (except -32 size)	H-9
Field Attachable	
069 "D" series	I-18
247 "N" series (except -20, -24, & -32 size)	I-23

Transportation

Engine and air brake hose

F

H213 Truck hose

Meets: SAE J1402 TYPE AI, DOT AI



# Part number	Hose I.D.		Hose O.D.		Maximum operating pressure		Minimum burst pressure		Minimum bend radius		Weight		Avail. lengths	
	DN	mm	in	mm	in	bar	psi	bar	psi	mm	in	kg/m	lbs/ft	feet
H21304 H21304-250R	5	4,8	0.19	12,3	0.50	140	2,000	560	8,000	19,1	.75	0.18	0.12	50 250
H21305 H21305-250R	6	6,4	0.25	13,9	0.57	105	1,500	420	6,000	25,4	1.00	0.22	0.15	50 250
H21306 H21306-250R	8	7,9	0.31	15,5	0.63	105	1,500	420	6,000	31,8	1.25	0.25	0.17	50 250
H21308 H21308-250R	10	10,3	0.41	18,7	0.75	87	1,250	350	5,000	44,5	1.75	0.31	0.21	50 250
H21310 H21310-250R	12	12,7	0.50	21,0	0.84	70	1,000	280	4,000	57,2	2.25	0.36	0.24	50 250
H21312 H21312-250R	16	15,9	0.62	24,2	0.97	52	750	210	3,000	69,9	2.75	0.93	0.26	50 250
H21316* H21316-250R	22	22,2	0.88	30,6	1.22	28	400	113	1,600	88,9	3.50	0.49	0.33	50 250

* 16 size is not SAE J1402 or DOT approved for air brake applications.

Construction

Tube: CPE

Reinforcement:
1 single wire braid

Cover: Textile braid

Operating parameters

Hot oil:
-45°C to +150°C
(-50°F to +302°F)

Air brake:
-40°C to +93°C
(-40°F to +200°F)

Application

- General purpose truck hose
- For use in air brake, fuel, diesel fuel and high temperature petroleum oil applications

For more information on agency listings, specific fluid applications and high temperature ratings see section A.

Fitting reference	Page
Crimp	
069 "E" series	H-9
229 "P" series	H-24
Field Attachable	
213 "N" series	I-20

H229 Truck hose

Meets: SAE J1402 TYPE AII, DOT AII



# Part number	Hose I.D.			Hose O.D.		Maximum operating pressure		Minimum burst pressure		Minimum bend radius		Weight		Avail. lengths
	DN	mm	in	mm	in	bar	psi	bar	psi	mm	in	kg/m	lbs/ft	
H22904	5	4,8	0.19	13,7	0.54	16	225	140	2,000	38,0	1.50	0.13	0.05	50
H22906 H22906-250R	8	7,9	0.31	19,1	0.75	16	225	140	2,000	50,8	2.00	0.19	0.13	50 250
H22908 H22908-250R	10	10,3	0.41	23,1	0.91	16	225	140	2,000	58,7	2.31	0.22	0.15	50 250
H22910	12	12,7	0.50	27,7	1.01	16	225	124	1,800	69,8	2.75	0.31	0.21	50
H22910	16	15,9	0.62	31,8	1.25	16	225	124	1,800	82,5	3.25	0.40	0.27	50

* 16 size not SAE or DOT approved for air brake applications.

Construction

Tube: Nitrile

Reinforcement:
1 textile braid

Cover: Textile braid

Operating parameters

Hydraulic:
-40°C to +100°C
(-40°F to +212°F)

Air brake:
-45°C to +100°C
(-40°F to +212°F)

Application

- General purpose truck hose
- High temperature hydraulic, air brake and diesel fuel applications

For more information on agency listings, specific fluid applications and high temperature ratings see section A.

Fitting reference	Page
Crimp	
069 "E" series	H-9
229 "P" series (-6 to -10)	H-24
Field Attachable	
069 "D" series	I-18
247 "N" series	I-23

Transportation

Engine and air brake hose

F

H239 Truck hose

Meets: SAE J1402 TYPE AII, DOT AII



# Part number	Hose I.D.			Hose O.D.		Maximum operating pressure		Minimum burst pressure		Minimum bend radius		Weight		Avail. lengths feet
	DN	mm	in	mm	in	bar	psi	bar	psi	mm	in	kg/m	lbs/ft	
H23904 H23904-250R	5	4,8	0.19	13,7	0.54	16	225	140	2,000	38,1	1.50	0.13	0.09	50 250
H23906 H23906-250R	8	7,9	0.31	17,7	0.07	16	225	140	2,000	50,8	2.00	0.19	0.13	50 250
H23908 H23908-250R	10	10,3	0.41	20,3	0.80	16	225	140	2,000	58,7	2.31	0.22	0.15	50 250
H23910 H23910-250R	12	12,7	0.50	24,1	0.95	16	225	124	1,800	69,9	2.75	0.34	0.23	50 250
H23912 H23912-250R	16	15,9	0.63	27,4	1.01	16	225	124	1,800	82,5	3.25	0.43	0.29	50 250
H23916* H23916-250R*	22	22,2	0.88	32,0	1.26	16	225	69	1,000	101,6	4.00	0.47	0.32	50 250
H23920* H23920-250R*	29	28,6	1.12	38,7	1.52	16	225	69	1,000	139,7	5.50	0.60	0.40	50 250

* Sizes 16 and 20 are not SAE nor DOT approved for air brake applications.

Construction

Tube: CPE

Reinforcement:
1 textile braid

Cover: Black textile braid

Operating parameters

Hot oil:
-40°C to +150°C
(-40°F to +302°F)

Air brake:
-40°C to +93°C
(-40°F to +200°F)

Application

- High temperature medium pressure truck hose for use in transmission oil cooler lines, fuel lines, diesel fuel and air brake lines
- Resistant to air, diesel fuel and petroleum base fluids

Fitting reference	Page
Crimp 069 "E" series	H-9
229 "P" series (-6 to -10)	H-24

H429

Truck hose

Meets: SAE J1019



# Part number	Hose I.D.			Hose O.D.		Maximum operating pressure		Minimum burst pressure		Minimum bend radius		Weight		Avail. lengths feet
	DN	mm	in	mm	in	bar	psi	bar	psi	mm	in	kg/m	lbs/ft	
H42908 H42908-250R	10	10,3	0.41	17,5	0.69	17,2	250	69	1,000	44,5	1.75	0,31	0.21	50 250
H42910 H42910-250R	12	12,7	0.50	20,1	0.79	17,2	250	69	1,000	57,2	2.25	0,43	0.29	50 250

Construction

Tube: CPE

Reinforcement:
1 wire braid

Cover: Textile braid

Operating parameters

-48°C to +150°C
(-55°F to +302°F)

Application

- High temperature truck hose for use in transmission oil cooler lines, fuel lines and diesel fuel lines
- Oil and temperature resistant tube

For more information on agency listings, specific fluid applications and high temperature ratings see section A.

Fitting reference	Page
Crimp 757 "E" series	H-15
057 "P" series	H-23

H569 Hydraulic hose

Meets: SAE 100R5, SAE J1942/1, J1402 TYPE AII, ABS



F

# Part number	Hose I.D.		Hose O.D.		Maximum operating pressure		Minimum burst pressure		Minimum bend radius		Weight		Avail. lengths
	DN	mm in	mm in	bar psi	bar psi	mm in	kg/m lbs/ft						
H56904 H56904-250R	5	4,8 0.19	13,7 0.54	210 3,000	840 12,000	75 2.95	0,24 0.16	50 250					
H56905 H56905-250R	6	6,4 0.25	15,2 0.60	210 3,000	840 12,000	85 3.35	0,30 0.20	50 250					
H56906 H56906-250R	8	7,9 0.31	17,8 0.70	157 2,250	630 9,000	100 3.94	0,34 0.23	50 250					
H56908 H56908-250R	10	10,3 0.41	20,1 0.79	140 2,000	560 8,000	115 4.53	0,40 0.27	50 250					
H56910 H56910-250R	12	12,7 0.50	23,9 0.94	122 1,750	490 7,000	140 5.51	0,54 0.36	50 250					
H56912 H56912-250R	16	15,9 0.62	27,9 1.10	105 1,500	420 6,000	165 6.50	0,65 0.44	50 250					
H56916 H56916-250R	22	22,2 0.88	32,3 1.27	56 800	224 3,200	185 7.28	0,68 0.46	50 250					
H56920 H56920-250R	29	28,6 1.12	38,9 1.53	43 625	175 2,500	230 9.06	0,76 0.51	50 250					

* Air brake applications, sizes -04 through -12 only.

Marine Application - Hydraulic only. ABS approved for sizes 5/16 through 1-1/8 inches.

Construction

Tube: CPE

Reinforcement: 1 textile braid, 1 single wire braid

Cover: Blue textile braid

Operating parameters

Hydraulic fluid:
-48°C to +150°C
(-55°F to +302°F)

Air brake:
-40°C to +93°C
(-40°F to +200°F)*

Air:
-40°C to +100°C
(-40°F to +212°F)
Intermittent to +250°F

Application

- General purpose truck, marine and hydraulic hose
- For use in air brake*, diesel fuel, grease lines, high temperature petroleum oils and medium pressure hydraulic applications

For more information on agency listings, specific fluid applications and high temperature ratings see section A.

Fitting reference	Page
Crimp	
069 "E" series	H-9
Field Attachable	
247 "N" series (sizes -6 to -12)	I-23

Transportation

Diesel and biodiesel hose

F

GH100 Braided textile - diesel and biodiesel hose

High temperature, low pressure oil
Meets: ASTM D380, ASTM D6751, EN412, EN2240



# Part number	Hose I.D.		Hose O.D.		Maximum operating pressure		Minimum burst pressure		Minimum bend radius		Vacuum service		Weight		Avail. lengths feet
	DN	mm in	mm in	bar psi	bar psi	mm in	kPa in	kg/m lbs/ft							
GH100-4-50 GH100-4-250R	6	6,4 0.25	13,8 0.54	28,0 400	112,0 1600	31,8 1.25	94,8 28	0,12 0.08	50 250						
GH100-6-50 GH100-6-250R	10	9,5 0.38	16,6 0.65	28,0 400	112,0 1600	38,1 1.50	94,8 28	0,15 0.10	50 250						
GH100-8-50 GH100-8-250R	12	12,7 0.50	20,1 0.79	28,0 400	112,0 1600	50,8 2.00	94,8 28	0,19 0.13	50 250						
GH100-10-50 GH100-10-250R	16	15,9 0.62	24,1 0.96	24,0 350	98,0 1400	63,5 2.50	94,8 28	0,27 0.18	50 250						
GH100-12-50 GH100-12-250R	19	19,0 0.75	28,2 1.11	24,0 350	98,0 1400	76,2 3.00	94,8 28	0,30 0.20	50 250						

Construction

Tube: Eaton developed HNBR

Reinforcement: Aramid braid

Cover: Textile braid

Operating parameters

Up to B20:
-40°C to +150°C
(-40°F to +302°F)

Up to B100:
-40°C to +125°C
(-40°F to +257°F)

Oil-transmission application:
-40°C to +165°C
-40°F to 320°F

Application

- For diesel and biodiesel use
- Low pressure oil applications, including synthetics for transmission oil cooler applications
- Qualified with ultra-low-sulfur diesel (ULSD), every blend of biodiesel up to B100, and a variety of synthetic oils

For more information on agency listings, specific fluid applications and high temperature ratings see section A.

Fitting reference	Page
Crimp 327 "E" series	H-13

Contact Eaton for custom tube designs.

GH101

CPE rubber - diesel and biodiesel hose

High temperature, low pressure oil
Meets: ASTM D380, ASTM D6751, EN412, EN2240



# Part number	Hose I.D.			Hose O.D.		Maximum operating pressure		Minimum burst pressure		Minimum bend radius		Vacuum service		Weight		Avail. length
	DN	mm	in	mm	in	bar	psi	bar	psi	mm	in	kPa	in	kg/m	lbs/ft	
GH101-4-50	6	6,4	0.25	14,6	0.57	28,0	400	112	1600	31,8	1.25	94,8	28	0,14	0.09	50
GH101-6-50	10	9,5	0.38	17,4	0.69	28,0	400	112	1600	38,1	1.50	94,8	28	0,18	0.12	50
GH101-8-50	12	12,7	0.50	21,2	0.83	28,0	400	112	1600	50,8	2.00	94,8	28	0,25	0.17	50
GH101-10-50	16	15,9	0.62	24,5	0.96	28,0	400	112	1600	69,8	2.75	94,8	28	0,28	0.19	50

Construction

Tube: Eaton developed HNBR
Reinforcement: Aramid braid
Cover: CPE Cover

Operating parameters

Up to B20:
-40°C to +150°C
(-40°F to +302°F)
Up to B100:
-40°C to +125°C
(-40°F to +257°F)

Application

- Engine fuel systems for diesel and biodiesel use
- Low pressure oil applications, including synthetics for transmission oil cooler applications

For more information on agency listings, specific fluid applications and high temperature ratings see section A.

Fitting reference	Page
-------------------	------

Crimp	
--------------	--

327 "E" series	H-13
----------------	------

Contact Eaton for custom tube designs; Brass connections, composite connections and brass crimp fitting options.

Transportation

Fuel line hose

F

H057

Fuel line hose

Exceeds: SAE 30R7



# Part number	Hose I.D.		Hose O.D.		Maximum operating pressure		Minimum burst pressure		Minimum bend radius		Vacuum service		Weight		Avail. length feet
	DN	mm in	mm in	bar psi	bar psi	mm in	kPa in	kg/m lbs/ft							
H05703-25R H05703-100R	5	4,8 0.19	10,9 0.43	3,4 50	17,2 250	31,8 1.25	94,8 24	0,09 0.06	25 100						
H05704-25R H05704-100R H05704-250R H05704-500R	6	6,4 0.25	3,2 0.52	3,4 50	17,2 250	31,8 1.25	94,8 24	0,13 0.09	25 100 250 500						
H05705-25R H05705-100R H05705-500R	8	7,9 0.31	15,0 0.59	3,4 50	17,2 250	31,8 1.50	94,8 24	0,16 0.11	25 100 250						
H05706-25R H05706-50R H05706-250R	10	9,5 0.38	16,6 0.65	3,4 50	17,2 250	50,8 2.00	94,8 24	0,18 0.12	25 100 250						

Construction

Tube: Nitrile

Reinforcement:

1 textile braid

Cover: Hypalon*

*Hypalon is a registered trademark of E.I. du Pont

Operating parameters

-40°C to +125°C
(-40°F to +275°F)

Application

- Small engine fuel systems for gasoline, ethanol, diesel and up to B20 Biodiesel
- Low pressure/high temperature fuel for passenger cars and light trucks; also small engine applications
- Not intended for fuel injection applications

For more information on agency listings, specific fluid applications and high temperature ratings see section A.

Fitting reference	Page
Field Attachable	
057 "B" series	I-9

H059

Marine fuel-oil-lube hose

Meets: SAE J1942/1, NMMA³, 33CFR183, ABS



# Part number	Hose I.D.			Hose O.D.		Maximum operating pressure		Minimum burst pressure		Minimum bend radius		Weight		Avail. lengths feet
	DN	mm	in	mm	in	bar	psi	bar	psi	mm	in	kg/m	lbs/ft	
H05904	5	4,8	0.19	14,0	0.55	35	500	140	2,000	19,1	.75	0,24	0.16	50
H05905	6	6,4	0.25	15,2	0.60	35	500	140	2,000	25,4	1.00	0,30	0.20	50
H05906	8	7,9	0.31	17,8	0.70	35	500	140	2,000	31,8	1.25	0,39	0.26	50
H05908	10	10,3	0.41	20,1	0.79	35	500	140	2,000	44,5	1.75	0,43	0.29	50
H05910	12	12,7	0.50	24,4	0.96	35	500	140	2,000	57,2	2.25	0,60	0.40	50
H05912	16	15,9	0.62	27,9	1.10	35	500	140	2,000	69,9	2.75	0,68	0.46	50
H05916	22	22,2	0.88	32,8	1.29	35	500	140	2,000	88,9	3.50	0,71	0.48	50

³ Size -5 does not meet NMMA standards.

Marine Application SAE J1942/1 Fuel and Lube Service, ABS

Construction

Tube: Special Blended Nitrile

Reinforcement:

1 single wire braid,
1 Nomex* braid

Cover: CPE

Operating parameters

-20°C to +100°C
(-4°F to +212°F)

*Nomex is a trademark of The Chemours Company FC, LLC.

Application

- Marine fuel, oil and lube hose is specially designed for gas and diesel marine engines
- Its blue cover makes it easily identified in marine environments

Fitting reference	Page
Crimp	
069 "E" series	H-9
229 "P" series (-6, -8 & -10)	H-24
Field Attachable	
247 "N" series	I-23

For more information on agency listings, specific fluid applications and high temperature ratings see section A.

35FH

Fuel line hose

EPA/CARB, SAE J1527B1-15

Meets: SAE J30R6, SAE J30R9, SAE J30R11



# Part number	Hose I.D.			Hose O.D.		Maximum operating pressure		Minimum burst pressure		Minimum bend radius		Vacuum service		Weight		Avail. lengths feet
	DN	mm	in	mm	in	bar	psi	bar	psi	mm	in	kPa	in	kg/m	lbs/ft	
35FH-40203-001	6	6,4	0.25	12,4	0.49	12,0	175	48,2	700	38,1	1.50	94,8	28	0,124	0.083	300
35FH-40201-001*																100*
35FH-50203-001	8	7,9	0.31	14,2	0.56	12,0	175	48,2	700	38,1	1.50	94,8	28	0,143	0.096	300
35FH-50207-001*																75*
35FH-60203-001	10	9,5	0.37	15,9	0.63	12,0	175	48,2	700	38,1	1.50	94,8	28	0,156	0.105	300
35FH-60206-001*																50*

* Retail roll package

Construction

Tube: PVDF

Reinforcement: Polyester

Cover: Black PVC alloy

Operating parameters

-40°C to +71°C
(-40°F to +160°F)

Application

- Small engine, outboard marine and turf care fuel systems for gasoline, diesel and up to B20 Biodiesel, where CARB (EPA certification) is require

Fitting reference	Page
Field Attachable	
100 "B" series	I-11

Meets the requirements of the International Marine Certification Institutes Recreational Craft Directive 94/25/EC. Qualified to applicable portions of SAE J1527B1-15, SAE J30R6, R9 and 30R11 specifications

Transportation

Silicone hose

F

EH225

Heater hose

Meets: SAE J20 R3 Class A

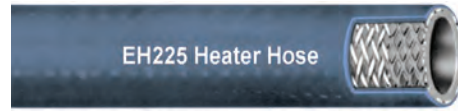

# Part number	Hose I.D.		Hose O.D.		Minimum burst pressure		Length ft/box
	mm	in	mm	in	bar	psi	
EH22504	6,40	0.25	11,70	0.46	28,0	400	25
EH22505	7,90	0.31	13,20	0.52	21,0	300	25
EH22506	9,70	0.38	16,30	0.64	17,0	250	25
EH22508	12,70	0.50	19,30	0.76	17,0	250	25
EH22510	16,00	0.63	23,60	0.93	17,0	250	25
EH22512	19,10	0.75	27,20	1.07	14,0	200	25
EH22514	22,40	0.88	31,50	1.24	14,0	200	25
EH22516	25,40	1.00	35,10	1.38	12,0	175	25

Construction

Tube: Silicone

Reinforcement: Single ply polyester braid

Cover: Blue

Operating parameters

-54°C to +177°C
(-65°F to +350°F)

Application

- Heater engine

For additional sizes and configurations refer to Eaton bulletin E-HOOV-MC004-E3.

EH226

Coolant hose

Meets: SAE J20 R1 Class A



# Part number	Hose I.D.		Hose O.D.		Minimum burst pressure		Length ft/box
	mm	in	mm	in	bar	psi	
EH22605	7,90	0.31	17,50	0.69	74,50	1080	3
EH22606	8,70	0.38	19,10	0.75	73,10	1060	3
EH22608	12,70	0.50	22,10	0.87	60,10	872	3
EH22610	15,70	0.62	25,10	0.99	55,00	797	3
EH22612	19,10	0.75	28,40	1.12	52,70	764	3
EH22614	22,40	0.88	31,80	1.25	50,50	732	3
EH22616	25,40	1.00	34,80	1.37	48,20	699	3
EH22617	26,90	1.06	36,60	1.44	46,70	678	3
EH22618	28,70	1.13	38,10	1.50	45,40	658	3
EH22620	31,80	1.25	41,10	1.62	42,50	617	3
EH22622	35,10	1.38	44,40	1.75	37,90	550	3
EH22624	38,10	1.50	47,50	1.87	35,90	521	3
EH22626	41,10	1.62	50,50	1.99	34,50	501	3
EH22628	44,40	1.75	53,80	2.12	32,60	473	3
EH22630	47,80	1.88	57,20	2.25	31,00	450	3
EH22632	50,80	2.00	60,20	2.37	30,50	442	3
EH22634	54,10	2.13	63,50	2.50	29,30	425	3
EH22636	57,20	2.25	66,50	2.62	28,50	413	3
EH22638	60,50	2.38	69,90	2.75	27,60	400	3
EH22640	63,50	2.50	72,90	2.87	26,10	379	3
EH22642	66,50	2.62	75,90	2.99	24,20	351	3
EH22644	69,80	2.75	79,20	3.12	23,30	338	3
EH22646	73,20	2.88	82,60	3.25	22,10	321	3
EH22648	76,20	3.00	85,60	3.37	21,90	317	3
EH22650	79,50	3.13	88,90	3.50	21,20	308	3
EH22652	82,60	3.25	91,90	3.62	20,50	298	3
EH22654	85,90	3.38	95,20	3.75	19,00	275	3
EH22656	86,90	3.50	98,30	3.87	18,20	264	3
EH22658	92,20	3.63	101,60	4.00	17,60	256	3
EH22660	95,20	3.75	104,60	4.12	17,20	249	3
EH22664	101,60	4.00	111,00	4.37	16,10	233	3
EH22666	104,90	4.13	114,60	4.51	N/A	N/A	3
EH22668	108,00	4.25	117,90	4.84	N/A	N/A	3
EH22672	114,30	4.50	123,70	4.87	N/A	N/A	3
EH22680	127,00	5.00	136,40	5.37	N/A	N/A	3
EH22688	139,70	5.50	149,10	5.87	N/A	N/A	3
EH22696	152,40	6.00	161,80	6.37	N/A	N/A	3

Construction

Tube: Silicone

Reinforcement: 4-ply woven polyester

Cover: Blue

Operating parameters

-54°C to +177°C
(-65°F to +350°F)

Application

- Coolant engine

For additional sizes and configurations refer to Eaton bulletin E-HOOV-MC004-E3.

Transportation

Silicone hose

F

EH227

Turbo hose, 4-Ply

Meets SAE J20R1, Class A



# Part number	Hose I.D.		Hose O.D.		Minimum burst pressure		Length ft/box
	mm	in	mm	in	bar	psi	
EH22704	6,40	0.25	14,50	0.57	32,9	477	3
EH22706	9,70	0.38	17,80	0.70	32,9	477	3
EH22708	12,70	0.50	20,80	0.82	29,3	425	3
EH22710	16,00	0.63	24,10	0.95	25,9	376	3
EH22712	19,10	0.75	27,20	1.07	22,4	325	3
EH22714	22,40	0.88	30,50	1.20	22,4	325	3
EH22716	25,40	1.00	33,50	1.32	20,6	300	3
EH22717	26,90	1.06	35,10	1.38	20,6	300	3
EH22718	28,70	1.13	36,80	1.45	19,0	276	3
EH22720	31,80	1.25	39,90	1.57	19,0	276	3
EH22721	33,30	1.31	41,40	1.63	19,0	276	3
EH22722	35,10	1.38	43,20	1.70	19,0	276	3
EH22724	38,10	1.50	46,20	1.62	17,2	249	3
EH22726	41,10	1.62	49,30	1.94	17,2	249	3
EH22728	44,40	1.75	52,60	2.07	15,5	225	3
EH22730	47,80	1.88	55,90	2.20	13,8	200	3
EH22732	50,80	2.00	58,90	2.32	13,8	200	3
EH22734	54,10	2.13	62,20	2.45	12,1	175	3
EH22736	57,20	2.25	65,30	2.57	12,1	175	3
EH22738	60,50	2.38	68,60	2.70	12,1	175	3
EH22740	63,50	2.50	71,60	2.82	10,3	149	3
EH22742	66,50	2.62	74,70	2.94	8,6	125	3
EH22744	69,80	2.75	78,00	3.07	8,6	125	3
EH22746	73,20	2.88	81,30	3.20	6,0	87	3
EH22748	76,20	3.00	84,30	3.32	6,0	87	3
EH22750	79,50	3.13	87,60	3.45	5,2	75	3
EH22752	82,60	3.25	90,70	3.57	5,2	75	3
EH22754	85,90	3.38	94,00	3.70	5,2	75	3
EH22756	88,90	3.50	97,00	3.82	5,2	75	3
EH22758	92,20	3.63	100,30	3.95	3,8	49	3
EH22760	95,20	3.75	103,40	4.07	3,8	49	3
EH22764	101,60	4.00	109,70	4.32	3,8	49	3
EH22772	114,30	4.50	122,40	4.82	3,8	49	3
EH22780	127,00	5.00	135,10	5.32	3,8	49	3

Construction

Tube: Silicone

Reinforcement: 4-ply woven aramid

Cover: Red

Operating parameters

-54°C to +260°C
(-65°F to +500°F)

Application

- High temperature engine

For additional sizes and configurations refer to Eaton bulletin E-HOOV-MC004-E3.

H324

Power steering hose



F

# Part number	Hose I.D.			Hose O.D.		Maximum operating pressure		Minimum burst pressure		Minimum bend radius		Weight		Avail. lengths
	DN	mm	in	mm	in	bar	psi	bar	psi	mm	in	kg/m	lbs/100ft	feet
H32406*	10	9,5	0.38	19,8	0.78	78	1,125	310	4,500	101,6	4.00	0,31	0.21	50

* See pages XXXXXXX for Power Steering Makeup information.

Construction

Tube: Nitrile

Reinforcement:
2 textile braids

Cover: Neoprene

Operating parameters

-40°C to +120°C
(-40°F to +250°F)

Application

- Passenger car/
light truck power
steering hose

For more information on agency listings, specific fluid applications and high temperature ratings see section A.

Fitting reference

Crimp

See Catalog # W-HYOV-MC002-E3 (section-J) for available "U" series fittings

Transportation

LPG hose

F

H366

Liquid propane gas hose (LPG)

UL File Number MH 6776, ULMH 10198



# Part number	Hose I.D.		Hose O.D.		Maximum operating pressure		Minimum burst pressure		Minimum bend radius		Weight		Avail. lengths	
	DN	mm	in	mm	in	bar	psi	bar	psi	mm	in	kg/m	lbs/ft	feet
H36606 H36606-250R	8	7,9	0.31	18,3	0.72	24	350	122	1,750	101,6	4.00	0,27	0.18	50 250
H36608	10	10,3	0.41	20,3	0.80	24	350	122	1,750	117,6	4.63	0,31	0.21	50

Construction

Tube: Nitrile

Reinforcement:

- 1 textile braid
- 1 stainless steel braid

Cover: Textile braid

Operating parameters

-40°C to +149°C
(-40°F to +300°F)

Application

- Most commonly used for medium pressure LP gas service
- UL listed for LP gas applications

For more information on agency listings, specific fluid applications and high temperature ratings see section A.

Fitting reference	Page
Crimp	
069 "E" series	H-9
Field Attachable	
069 "D" series	I-18
247 "N" series	I-23

H900

Liquid propane gas hose (LPG)

UL 21 Approved LP-Gas

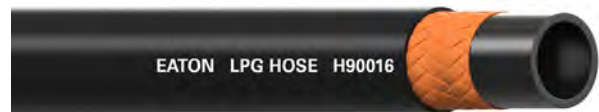

# Part number	Hose I.D.		Hose O.D.		Maximum operating pressure		Minimum burst pressure		Weight		Avail. lengths	
	DN	mm	in	mm	in	bar	psi	bar	psi	kg/m	lbs/ft	feet
H90004-500R	6	6,4	0.25	15,5	0.61	24	350	122	1,750	0.18	0.12	500
H90006-500R	10	9,5	0.38	19,1	0.75	24	350	122	1,750	0.25	0.17	500
H90008-500R	12	12,7	0.50	23,9	0.94	24	350	122	1,750	0.36	0.24	500
H90012-500R	19	19,1	0.75	31,8	1.25	24	350	122	1,750	0.61	0.41	500
H90016-150 H90016-300R	25	25,4	1.00	38,9	1.53	24	350	122	1,750	0.77	0.52	150 300

Construction

Tube: Nitrile

Reinforcement:

- Textile braid
- (1" has 2 stainless steel static wires)

Cover: Vinyl nitrile, pinpricked

Operating parameters

-40°C to +60°C
(-40°F to +140°F)

Hose is capable of this rating. LP-gas should never be elevated above 37.8°C (100°F).

Application

- Transfer and delivery of propane and butane
- UL listed for LP gas applications

For more information on agency listings, specific fluid applications and high temperature ratings see section A.

Fitting reference
Crimp
See catalog # W-HYOV-MC002-E3 (section-J) for available "U" series fittings

NG-TW

Low pressure CNG hose

Meets: ANSI/CSA NGV4.2-2014 CSA 12.52-2014,
ANSI/CSA NGV 3.1-2014/CSA 12.3-2014, ECE R110



# Part number	Hose I.D.		Hose O.D.		Maximum operating pressure		Minimum burst pressure		Minimum bend radius		Weight	
	mm	in	mm	in	bar	psi	bar	psi	mm	in	kg/m	lbs/ft
NG-6TW	7,9	0.31	13,6	0.54	30	435	120	1740	101,6	4.00	0,18	0.12
NG-8TW	10,6	0.42	16,4	0.65	30	435	120	1740	133,4	5.25	0,24	0.16
NG-10TW	12,7	0.50	19,1	0.75	30	435	120	1740	165,1	6.50	0,27	0.18

Construction

Tube: Static-Dissipating Teflon inner tube

Reinforcement: 304 stainless steel wire braid

Cover: Fire resistant black/polyester blend cover with a blue tracer

Teflon is a trademark of The Chemours Company FC, LLC used under license by Eaton.

Operating parameters

-40°C to +120°C
(-40°F to +248°F)

Application

- Designed for low pressure, high temperature CNG applications on equipment or vehicles

Features

- Dissipates static electricity
- Low volumetric expansion
- UV resistant cover
- Designed for electrically conductive fittings
- Eaton factory certified assemblies are available for purchase

For more information on agency listings, specific fluid applications and high temperature ratings see section A.

Fitting reference

Must be TUV certified to crimp assemblies.

Factory made hose assemblies are available for Eaton distribution. Contact Eaton for details.

See product brochure E-HOTH-TT001-E for fitting and certification information.

Certified by:



Transportation

Alternative fuel - CNG hose

F

Synflex 35NG High pressure CNG hose

Meets: ANSI/CSA NGV4.2-2014 CSA 12.52-2014,
ANSI/CSA NGV 3.1-2014/CSA 12.3-2014



# Part number	Hose size	Hose I.D.			Hose O.D.		Maximum working pressure		Minimum burst pressure		Minimum bend radius		Weight		Package Length	
		DN	mm	in	mm	in	bar	psi	bar	psi	mm	in	kg/m	lbs/ft	m	ft
35NG-04-250BX	-04	6	6,4	0.25	16,0	0.63	345	5,000	1,379	20,000	51,0	2.00	0,17	0.12	76,2	250
35NG-06-250BX	-06	10	9,7	0.38	19,5	0.77	345	5,000	1,379	20,000	102,0	4.00	0,22	0.15	76,2	250
35NG-08-250BX	-08	12	12,8	0.50	22,5	0.89	345	5,000	1,379	20,000	140,0	5.50	0,32	0.21	76,2	250
Twin-Line																
35NG-0404-250BX	04, -04	-	-	-	-	-	345	5,000	1,379	20,000	51,0	2.00	0,34	0.24	76,2	250
35NG-0406-250BX	04, -06	-	-	-	-	-	345	5,000	1,379	20,000	51,0	2.00	0,39	0.27	76,2	250
35NG-0408-250BX	04, -08	-	-	-	-	-	345	5,000	1,379	20,000	51,0	2.00	0,49	0.33	76,2	250

Construction

Tube: Conductive nylon core

Reinforcement:
Synthetic fiber

Cover: Black perforated polyurethane

Operating parameters

-40°C to +85°C
(-40°F to +185°F)

Application

- CNG refueling dispensers
- CNG transfer lines
- High-pressure CNG lines

Features

- Dissipates static electricity
- Low volumetric expansion
- UV resistant cover
- Twin-line designs available with vent hose
- Designed for electrically conductive fittings

For more information refer to the Synflex Thermoplastic Hose and Fittings E-HOOV-MC001-E.

Fitting reference

Factory made hose assemblies are available for Eaton distribution. Contact Eaton for details.

Eaton factory certified assemblies are available for purchase.

See product brochure E-HOTH-TT001-E for fitting and certification information.

Certified by:



Teflon hose

Full bore

H243.....	G-3
H277.....	G-4

Everflex reduced bore

S-Series	G-5
SC-Series	G-6
HI-PSI Series	G-7

Convolute

8000	G-8
8500	G-8

G

Teflon is a trademark of The Chemours Company FC, LLC used under license by Eaton.



Teflon hose

Full bore

H243 Full bore

G-3



H277 Full bore

G-4



Everflex reduced bore

S-Series Smooth bore non-dissipating

G-5



SC-Series Smooth bore static dissipating

G-6



Hi-PSI Series Smooth bore static dissipating

G-7



Convolute

8000 Non-dissipating

G-8



8500 Static dissipating

G-8



H243 non-dissipating Teflon hose (Thin wall)



# Part number	Hose I.D.		Hose O.D.		Working pressure		Minimum burst pressure		Minimum bend radius		Weight	
	mm	in	mm	in	bar	psi	bar	psi	mm	in	Kg/m	lbs/ft
H24303 H24303-150R	4,8	0.19	8,1	0.32	210	3,000	840 661,9	12,000 9,600*	50,8	2.00	0.09	0.06
H24304 H24304-100R	6,4	0.25	10,2	0.40	210	3,000	840 661,9	12,000 9,600*	76,2	3.00	0.12	0.08
H24305 H24305-100R	7,9	0.31	11,7	0.46	175	2,500	700 551,6	10,000 8,000*	101,6	4.00	0.15	0.10
H24306 H24306-100R	9,7	0.38	13,5	0.53	140	2,000	560 413,7	8,000 6,000*	127,0	5.00	0.16	0.11
H24308 H24308-100R	12,7	0.50	17,0	0.67	122	1,750	490 379,2	7,000 5,500*	165,1	6.50	0.25	0.17
H24312	19,1	0.75	23,1	0.91	70	1,000	280 241,3	4,000 3,500*	215,9	9.00	0.37	0.25
H24316	25,4	1.00	31,8	1.25	70	1,000	280 224,1	4,000 3,250*	304,8	12.00	0.79	0.53

* For applications above +300°F (+149°C).

Construction

Tube: Non-conductive Teflon inner tube

Cover: Single stainless steel braid, 1" size double Stainless Steel braid (Type 304)

Operating parameters

-54°C to +232°C
(-65°F to +450°F)

Application

- Hydraulic, air and steam lines
- Particularly suited for air compressor discharge lines where vibration and high temperatures are present

For more information on agency listings, specific fluid applications and high temperature ratings see section A or contact Eaton technical support.

Not for use in applications requiring static dissipation.

Fitting reference	Page
Crimp	
"E" series	H-2

Teflon is a trademark of The Chemours Company FC, LLC used under license by Eaton.

Teflon hose

Full bore

G

H277 static dissipating Teflon hose

(Thin wall)



# Part number	Hose I.D.		Hose O.D.		Working pressure		Minimum burst pressure		Minimum bend radius		Weight	
	mm	in	mm	in	bar	psi	bar	psi	mm	in	Kg/m	lbs/ft
H27703 H27703-150R	4,8	0.19	8.1	0.32	210	3,000	840	12,000	50,8	2.00	0.09	0.06
H27704 H27704-100R	6,4	0.25	10.2	0.40	175	3,000	840	12,000	76,2	3.00	0.12	0.08
H27705 H27705-100R	7,9	0.31	11.7	0.46	140	2,500	700	10,000	101,6	4.00	0.15	0.10
H27706 H27706-100R	9,7	0.38	13.5	0.53	122	2,000	560	8,000	127,0	5.00	0.16	0.11
H27708 H27708-100R	12,7	0.50	17.0	0.67	70	1,750	490	7,000	165,1	6.50	0.25	0.17
H27712	19,1	0.75	23.1	0.91	70	1,000	280	4,000	215,9	8.50	0.37	0.25
H27716	25,4	1.00	31.8	1.25	69,0	1,000	280	4,000	304,8	12.00	0.79	0.53

* For applications above +300°F (+149°C).

Construction

Tube: Conductive Teflon inner tube

Cover: Single stainless steel braid, 1" size double Stainless Steel braid (Type 304)

Operating parameters

-54°C to +232°C
(-65°F to +450°F)

Application

- Hydraulic, air and steam lines
- Particularly suited for air compressor discharge lines where vibration and high temperatures are present

For more information on agency listings, specific fluid applications and high temperature ratings see section A or contact Eaton technical support.

For use in applications requiring static dissipation.

Fitting reference	Page
Crimp	
"E" series	H-2

Teflon is a trademark of The Chemours Company FC, LLC used under license by Eaton.

S-Series

Everflex non-dissipating Teflon hose

(Thick wall)



# Part number	Hose I.D.		Hose O.D.		Working pressure		Minimum burst pressure		Minimum bend radius		Weight		Vacuum service
	mm	in	mm	in	bar	psi	bar	psi	mm	in	Kg/m	lbs/ft	In/Hg
304 Stainless steel braid													
S-3	3,2	0.13	6,8	0.27	241	3,500	965	14,000	25,4	1.00	0,07	0.05	28
S-4	4,8	0.19	8,6	0.34	206	3,000	827	12,000	38,1	1.50	0,12	0.08	28
S-5	6,4	0.25	10,2	0.40	206	3,000	827	12,000	50,8	2.00	0,13	0.09	28
S-6	7,9	0.31	11,7	0.46	172	2,500	689	10,000	88,9	3.50	0,18	0.12	28 ‡
S-8	10,4	0.41	14,7	0.58	137	2,000	551	8,000	114,3	4.50	0,22	0.15	28 ‡
S-10 *	12,7	0.50	17,3	0.68	120	1,750	482	7,000	127,0	5.00	0,30	0.20	28 ‡
S-12 *	15,7	0.62	20,3	0.80	103	1,500	413	6,000	152,4	6.00	0,34	0.23	28 ‡
S-16	22,4	0.88	27,2	1.07	68	1,000	275	4,000	228,6	9.00	0,46	0.31	12 ‡
S-16Z ◊	22,4	0.88	28,7	1.13	86	1,250	344	5,000	185,4	7.30	0,73	0.49	12 ‡
S-20Z ◊	28,4	1.12	35,3	1.39	68	1,000	275	4,000	279,4	11.00	0,97	0.65	12 ‡
316 Stainless steel braid													
S316-4	4,8	0.19	8,6	0.34	206	3,000	827	12,000	38,1	1.50	0,12	0.08	28
S316-6	7,9	0.31	11,7	0.46	172	2,500	689	10,000	88,9	3.50	0,18	0.12	28 ‡
S316-8	10,4	0.41	14,7	0.58	103	1,500	414	6,000	114,3	4.50	0,22	0.15	28 ‡
S316-12	15,7	0.62	20,1	0.78	86	1,250	345	5,000	152,4	6.00	0,34	0.23	28 ‡
S316-16	22,4	0.88	27,2	1.07	62	900	248	3,600	228,6	9.00	0,46	0.31	12 ‡

Construction

Tube: Heavy wall non-conductive Teflon inner tube

Cover: 304 or 316 stainless steel braid

Operating parameters

-54°C to +230°C
(-65°F to +450°F)

Application

- Steam
- Compressor discharge
- Chemical transfer
- 316 Stainless braided hose can be used in marine applications and other environments where corrosion is an issue

For more information on agency listings, specific fluid applications and high temperature ratings see section A or contact Eaton technical support.

Fitting reference Page

Crimp	
Everswage	H-93

Teflon is a trademark of The Chemours Company FC, LLC used under license by Eaton.

Warning: These hoses can be used to convey hazardous chemicals, steam, hot liquids or other dangerous materials which can cause death, serious bodily injury including burns, pressure wounds or chemical exposure if released accidentally. They should, therefore, only be handled or worked on by personnel properly trained in the safe handling of the materials or chemicals conveyed in the hoses.

◊ "Z" Designates a double braid of 304 stainless steel wire.

* The operating pressure of 1/2" I.D. hoses are lowered to 1500 psi and 5/8" I.D. hoses are lowered to 1250 psi when Brass Everswage fittings are used.

‡ Maximum negative pressure for -16 and larger are suitable for hose which has suffered no external damage or kinking. If greater negative pressures are required for -16 and larger hoses, the use of an internal support coil is recommended. Use of an internal support coil in -06 and larger hose is recommended for tube support where extended or continuous service at high temperature together with low or negative pressure is expected.

Teflon hose

Everflex reduced bore

G

SC-Series

Everflex static dissipating Teflon hose

(Thick wall)

Carbon black used meets 21CFR178.3297 for FDA compliance



# Part number	Hose I.D.		Hose O.D.		Working pressure		Minimum burst pressure		Minimum bend radius		Weight		Vacuum service
	mm	in	mm	in	bar	psi	bar	psi	mm	in	Kg/m	lbs/ft	In/Hg
304 Stainless steel braid													
SC-3	3,2	0.13	6,8	0.27	241	3,500	965	14,000	25,4	1.00	0,07	0.05	28
SC-4	4,8	0.19	8,6	0.34	206	3,000	827	12,000	38,1	1.50	0,12	0.08	28
SC-5	6,4	0.25	10,2	0.4	206	3,000	827	12,000	50,8	2.00	0,13	0.09	28
SC-6	7,9	0.31	11,7	0.46	172	2,500	689	10,000	88,9	3.50	0,18	0.12	28 ‡
SC-8	10,4	0.41	14,7	0.58	137	2,000	551	8,000	114,3	4.50	0,22	0.15	28 ‡
SC-10 *	12,7	0.50	17,3	0.68	120	1,750	482	7,000	127,0	5.00	0,30	0.20	28 ‡
SC-12 *	15,7	0.62	20,3	0.8	103	1,500	413	6,000	152,4	6.00	0,34	0.23	28 ‡
SC-16	22,4	0.88	27,2	1.07	68	1,000	275	4,000	228,6	9.00	0,46	0.31	12 ‡
316 Stainless steel braid													
SC316-4	4,8	0.19	8,6	0.34	206	3,000	827	12,000	38,1	1.50	0,12	0.08	28
SC316-6	7,9	0.31	11,7	0.46	172	2,500	689	10,000	88,9	3.50	0,18	0.12	28 ‡
SC316-8	10,4	0.41	14,7	0.58	103	1,500	414	6,000	114,3	4.50	0,22	0.15	28 ‡
SC316-12	15,7	0.62	20,1	0.78	86	1,250	345	5,000	152,4	6.00	0,34	0.23	28 ‡
SC316-16	22,4	0.88	27,2	1.07	62	900	248	3,600	228,6	9.00	0,46	0.31	12 ‡

Construction

Tube: Heavy wall conductive Teflon inner tube

Cover: One or two layers of stainless steel braid

Operating parameters

-54°C to +230°C
(-65°F to +450°F)

Application

- Steam
- Compressor discharge
- Chemical transfer
- 316 Stainless braided hose can be used in marine applications and other environments where corrosion is an issue

For more information on agency listings, specific fluid applications and high temperature ratings see section A or contact Eaton technical support.

Teflon is a trademark of The Chemours Company FC, LLC used under license by Eaton.

Fitting reference	Page
Crimp fittings	
Everswage	H-93

Warning: These hoses can be used to convey hazardous chemicals, steam, hot liquids or other dangerous materials which can cause death, serious bodily injury including burns, pressure wounds or chemical exposure if released accidentally. They should, therefore, only be handled or worked on by personnel properly trained in the safe handling of the materials or chemicals conveyed in the hoses.

‡ Maximum negative pressure for -16 and larger are suitable for hose which has suffered no external damage or kinking. If greater negative pressures are required for -16 and larger hoses, the use of an internal support coil is recommended. Use of an internal support coil in -06 and larger hose is recommended for tube support where extended or continuous service at high temperature together with low or negative pressure is expected.

◇ "Z" Designates a double braid of 304 stainless steel wire.

*The operating pressure of 1/2" I.D. hoses are lowered to 1500 psi and 5/8" I.D. hoses are lowered to 1250 psi when Brass Everswage fittings are used.

Hi-PSI Series

Everflex static dissipating Teflon hose

(Thick wall)



# Part number	Hose I.D.		Hose O.D.		Working pressure at 72°		Working pressure at 400°		Minimum burst pressure		Minimum bend radius		Weight		Vacuum service	
	mm	in	mm	in	bar	psi	bar	psi	bar	psi	mm	in	Kg/m	lbs/ft	kPa	in/Hg
H504	5,6	0.22	9,8	0.39	345	5,000	207	3,000	1,103	16,000	38,1	1.50	0,15	0.10	94,8	28
H506	8,0	0.31	13,1	0.52	345	5,000	207	3,000	1,103	16,000	63,5	2.50	0,25	0.17	94,8 ‡	28 ‡
H508	10,3	0.41	16,0	0.63	345	5,000	207	3,000	1,103	16,000	73,7	2.90	0,36	0.24	94,8 ‡	28 ‡
H510	12,7	0.50	19,3	0.76	345	5,000	207	3,000	1,103	16,000	83,8	3.30	0,51	0.34	94,8 ‡	28 ‡
H512	16,5	0.65	25,1	0.99	345	5,000	207	3,000	1,103	16,000	101,6	4.00	1,02	0.68	94,8 ‡	28 ‡
H516	22,2	0.88	33,4	1.32	345	5,000	207	3,000	1,103	16,000	127,0	5.00	1,72	1.16	40,6 ‡	12 ‡
H520	28,6	1.13	41,1	1.62	345	5,000	207	3,000	1,103	16,000	304,8	12.00	2,47	1.66	40,6 ‡	12 ‡
H524	34,9	1.38	47,5	1.87	276	4,000	207	3,000	827	12,000	355,6	14.00	2,97	1.99	40,6 ‡	12 ‡

Construction

Tube: Heavy wall conductive Teflon inner tube

Cover: One or two layers of 304 stainless steel wire braid

Operating parameters

-54°C to +240°C
(-65°F to +400°F)

Application

- Steam
- Compressor discharge
- Chemical transfer
- High pressure applications

For more information on agency listings, specific fluid applications and high temperature ratings see section A or contact Eaton technical support.

Fitting reference

Factory crimp only. For more information contact Eaton technical support.

Teflon is a trademark of The Chemours Company FC, LLC used under license by Eaton.

Hose/Tube size	Insert part number	Collar part number	Female JIC thread size	Hose assembly part number
-4	H20004-4-316/4	H70000-4-304	7/16-20	FK4650EEE-Length
-6	H20006-6-316/4	H70000-6-304	9/16-18	FK4650GGG-Length
-8	H20008-8-316/4	H70000-8-304	3/4-16	FK4650HHH-Length
-10	H20010-10-316/4	H70000-10-304	7/8-14	FK4650JJJ-Length
-12*	H20012-12-316/4	H70000-12-304	1-1/16-12	FK4650KKK-Length
-16*	H20016-16-316/4	H70000-16-304	1-5/16-12	FK4650MMM-Length
-20**	H20020-20-316/4	H70000-20-304	1-5/8-12	FK4650NNN-Length
-24**	H20024-24-316/4	H70000-24-304	1-7/8-12	FK4650PPP-Length

Hose assemblies must be assembled by Eaton. Standard stainless steel JIC fittings are available.

* 55' Max length

** 25' Max length



Warning: These hoses can be used to convey hazardous chemicals, steam, hot liquids or other dangerous materials which can cause death, serious bodily injury including burns, pressure wounds or chemical exposure if released accidentally. They should, therefore, only be handled or worked on by personnel properly trained in the safe handling of the materials or chemicals conveyed in the hoses.

‡ Maximum negative pressure for -16 and larger are suitable for hose which has suffered no external damage or kinking. If greater negative pressures are required for -16 and larger hoses, the use of an internal support coil is recommended. Use of an internal support coil in -06 and larger hose is recommended for tube support where extended or continuous service at high temperature together with low or negative pressure is expected.

Teflon hose

Convolute

G

8000 Series

Non-dissipating Teflon hose

(Convolute)

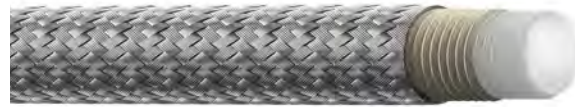

# Part number	Hose size	Nominal I.D.		Maximum nominal O.D.		Hose I.D.	Maximum operating pressure		Minimum burst pressure		Minimum bend radius		Weight		Vacuum service
		mm	in	mm	in		bar	psi	bar	psi	mm	in	kg/m	lbs/ft	
8008	-8	14.5	0.57	21.1	0.83	1/2	103	1500	414	6000	38,1	1.5	0,34	0.23	28
8012	-12	21.1	0.83	28.3	1.11	3/4	86	1250	345	5000	63,5	2.5	0,46	0.31	28
8016	-16	27.2	1.07	34.4	1.35	1	62	900	248	3600	76,2	3.0	0,62	0.42	20
8020	-20	33.3	1.31	40.9	1.61	1 1/4	62	900	248	3600	88,9	3.5	0,77	0.52	12
8024	-24	39.8	1.57	47.0	1.85	1 1/2	52	750	206	3000	114,3	4.5	0,88	0.59	10
8032	-32	52.4	2.06	61.2	2.41	2	35	500	138	2000	152,4	6.0	1,28	0.86	5

8500 Series

Static dissipating Teflon hose

(Convolute)



# Part number	Hose size	Nominal I.D.		Maximum nominal O.D.		Hose I.D.	Maximum operating pressure		Minimum burst pressure		Minimum bend radius		Weight		Vacuum service
		mm	in	mm	in		bar	psi	bar	psi	mm	in	kg/m	lbs/ft	
8508	-8	14,5	0.57	21,1	0.83	1/2	103	1500	414	6000	38,1	1.5	0,34	0.23	28
8512	-12	21,1	0.83	28,3	1.11	3/4	86	1250	345	5000	63,5	2.5	0,46	0.31	28
8516	-16	27,2	1.07	34,4	1.35	1	62	900	248	3600	76,2	3.0	0,62	0.42	20
8520	-20	33,3	1.31	40,9	1.61	1 1/4	62	900	248	3600	88,9	3.5	0,77	0.52	12
8524	-24	39,8	1.57	47,0	1.85	1 1/2	52	750	206	3000	114,3	4.5	0,88	0.59	10
8532	-32	52,4	2.06	61,2	2.41	2	34,5	500	138	2000	152,4	6.0	1,28	0.86	5

Construction

Tube: Convolute
Teflon inner tube

8000 Series: Non-conductive tube

8500 Series: Conductive tube

Reinforcement: 304 stainless steel wire braid

Operating parameters

-54°C to +204°C
(-65°F to +400°F)

Application

- Automotive
- Platen presses
- Pharmaceutical
- Bus and truck
- Reverse osmosis
- Hydraulics
- Chemical processing
- Steam, air, water
- Tire manufacturing
- Electronics
- Steel mills
- Food processing
- Tank truck transfer
- 8500 Series is for applications where flow induced electrostatic charges can occur.

For more information on agency listings, specific fluid applications and high temperature ratings see section A or contact Eaton technical support.

Fitting reference	Page
Crimp	
Conv-O-Crimp	H-91

Teflon is a trademark of The Chemours Company FC, LLC used under license by Eaton.

Warning: These hoses can be used to convey hazardous chemicals, steam, hot liquids or other dangerous materials which can cause death, serious bodily injury including burns, pressure wounds or chemical exposure if released accidentally. They should, therefore, only be handled or worked on by personnel properly trained in the safe handling of the materials or chemicals conveyed in the hoses.

Crimp fittings

'E' series	H-2	'Z' series	H-29	
069 'E' series	H-9	Spiral hose fittings (4S/6S).....	H-55	H
327 'E' series.....	H-13	Everflex hose ends		
757 'E' series.....	H-15	Conv-O-Crimp.....	H-91	
057 'P' series.....	H-23	Everswage	H-93	
229 'P' series.....	H-24			
265 'P' series.....	H-25			
338 'P' series.....	H-26			



Crimp fittings

'E' series

To determine the correct length of hose, subtract the cut-off factor for each end fitting from the overall length of assembly.

H

'E' series

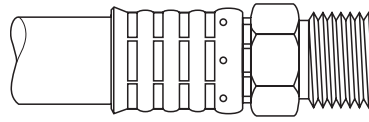

Ordering information:
Order individually part number.

Compatible hose
H009, H243, H275, H277, H285

⚠ WARNING

For PTFE hose applications, 'E' series fittings must be used with H243 and H277 .030" thin wall hose only

Pressure: Determined by maximum operating pressure for hose size and hose end configuration whichever is lesser. See pages A-24-25 for operating pressure ratings for hose end configurations.

Material: Low carbon steel

Plating: Zinc; clear trivalent chromate

Assemble with: ET1000, ET4000, T-400-1, T-410-1, T-420-1, T-440-1, T-460, T-462, T-465-1, T480, ET4001

Label set: FS-1200

Note:

Refer to current price list for availability of cataloged items. Configurations and dimensions subject to change without notice.

Application: General purpose low- and medium-pressure hydraulics. Use H277 where shock hazards exist.

Advantages: Wide selection of hose and end configurations allowing for a diverse number of applications where hose compatibility is a problem.

⚠ Refer to important safety information on page A-2.

Male pipe rigid

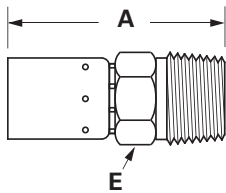

Hose I.D.	Pipe size	Carbon steel part number	Stainless steel part number	Thread size	A	Hose cut-off factor	Hole dia.	Hex E
3/16	1/8	03E-102		1/8-27	1.58	0.75	.09	7/16
3/16	1/4	03E-104	03ER-104	1/4-18	1.83	1.00	.09	9/16
1/4	1/8	04E-102		1/8-27	1.60	0.75	.16	7/16
1/4	1/4	04E-104		1/4-18	1.79	1.00	.16	9/16
1/4	3/8	04E-106		3/8-18	1.82	1.00	.16	11/16
5/16	1/4	05E-104	05ER-104	1/4-18	1.86	0.94	.22	9/16
5/16	3/8	05E-106		3/8-18	1.89	1.00	.22	11/16
3/8	1/4	06E-104		1/4-18	1.90	1.00	.27	9/16
3/8	3/8	06E-106		3/8-18	1.93	1.00	.27	11/16
3/8	1/2	06E-108		1/2-14	2.17	1.25	.27	7/8
1/2	3/8	08E-106		3/8-18	2.02	1.00	.38	3/4
1/2	1/2	08E-108	08ER-108	1/2-14	2.27	1.25	.38	7/8
3/4	3/4	12E-112		3/4-14	2.51	1.31	.61	1-1/16
1	1	16E-116		1-11-1/2	2.95	1.63	.84	1-3/8

Male pipe swivel

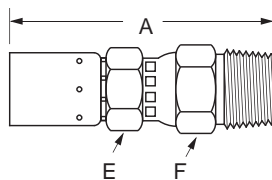

Hose I.D.	Pipe size	Part number	Thread size	A	Hose cut-off factor	Hole dia.	Hex E	Hex F
1/4	1/4	04E-J04	1/4-18	2.68	1.81	.16	5/8	13/16
5/16	1/4	05E-J04	1/4-18	2.75	8	13/16		
3/8	3/8	06E-J06	3/8-18	2.79	1.81	.27	11/16	7/8
1/2	1/2	08E-J08	1/2-14	3.03	2.00	.39	3/4	7/8
3/4	3/4	12E-J12	3/4-14	3.73	2.50	.61	1-1/4	1-1/4

Note: Swivel for installation purposes only. (Not for temperatures above 212°F.)

Teflon is a trademark of The Chemours Company FC, LLC used under license by Eaton.

To determine the correct length of hose, subtract the cut-off factor for each end fitting from the overall length of assembly.

'E' series

JIC 37° Male rigid

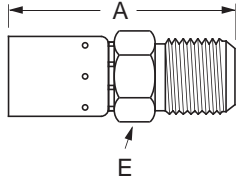

Hose I.D.	Tube size	Part number	Thread size	A	Hose cut-off factor	Hole dia.	Hex E
1/4	1/4	04E-504	7/16-20	1.78	0.94	.16	1/2
1/4	5/16	04E-505	1/2-20	1.78	0.94	.19	9/16
1/4	3/8	04E-506	9/16-18	1.82	1.00	.22	5/8
5/16	5/16	05E-505	1/2-20	1.86	0.94	.22	9/16
3/8	3/8	06E-506	9/16-18	1.92	1.00	.27	5/8
3/8	1/2	06E-508	3/4-16	2.08	1.19	.27	13/16
1/2	1/2	08E-508	3/4-16	2.18	1.19	.27	13/16
1/2	5/8	08E-510	7/8-14	2.31	1.25	.42	15/16
3/4	3/4	12E-512	1-1/16-12	2.63	1.44	.61	1-1/8
1	1	16E-516	1-5/16-12	2.83	1.50	.84	1-3/8

Inverted male swivel straight

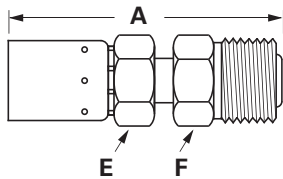

Hose I.D.	Pipe size	Part number	Thread size	A	Hose cut-off factor	Hole dia.	Hex E	Hex F
1/4	3/16	04E-B03	3/8-24	3.06	2.19	.12	7/16	3/8
1/4	1/4	04E-B04	7/16-24	2.44	1.63	.15	7/16	7/16
1/4	5/16	04E-B05	1/2-20	3.71	2.88	.16	7/16	1/2
5/16	5/16	05E-B05	1/2-20	2.57	1.61	.21	9/16	1/2
3/8	5/16	06E-B05	1/2-20	2.56	1.63	.21	9/16	1/2
3/8	3/8	06E-B06	5/8-18	2.81	1.81	.24	5/8	5/8
1/2	1/2	08E-B08	3/4-18	3.14	2.06	.33	3/4	3/4

Air brake connection — Tube

(For use with H243 PTFE hose Only)

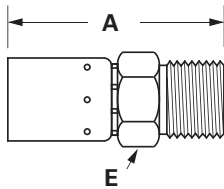

Hose I.D.	Tube size	Part number	Thread size	A	Hose cut-off factor	Hole dia.	Hex E	Tube size	Part number sleeve	Part number nut
1/2	1/2	08E-Y58	11/16-20	2.12	1.06	.38	3/4	3/8	1360x6	1361x6
1/2	5/8	08E-Y60	13/16-18	2.18	1.13	.38	7/8	1/2	1360x8	1361x8
3/4	5/8	12E-Y60	13/16-18	2.31	1.13	.53	1	5/8	1360x10	1361x10
3/4	3/4	12E-Y62	1-18	2.38	1.19	.61	1	3/4	1360x12	1361x12

Flareless tube rigid

(With Ermeto nut and sleeve)

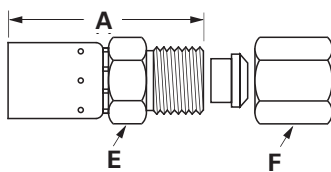

Hose I.D.	Tube size	Part number	Thread size	A	Hose cut-off factor	Hole dia.	Hex E	Hex F
5/16	3/8	05E-756	9/16-18	1.88	1.00	.22	5/8	11/16
3/8	5/16	06E-755	1/2-20	1.78	.88	.23	9/16	5/8
3/8	3/8	06E-756	9/16-18	1.82	.88	.27	5/8	11/16
1/2	1/2	08E-758	3/4-16	2.08	1.06	.38	13/16	7/8

(For replacement nuts and sleeves, see page J-144.)

Crimp fittings

'E' series

To determine the correct length of hose, subtract the cut-off factor for each end fitting from the overall length of assembly.

H

'E' series

JIC 37° Female swivel

(Exceptions noted)

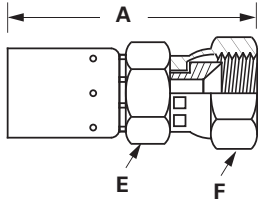

Hose I.D.	Tube size	Carbon steel part number	Stainless steel part number	Thread size	A	Hose cut-off factor	Hole dia.	Hex E	Hex F
3/16	1/4	03E-604 ^a	03ER-604	7/16-20	1.89	1.00	.09	7/16	9/16
1/4	1/4	04E-604 ^a		7/16-20	1.92	1.13	.16	7/16	9/16
1/4	5/16	04E-605 ^a		1/2-20	2.00	1.19	.16	1/2	5/8
1/4	3/8	04E-606		9/16-18	2.06	1.25	.16	9/16	11/16
5/16	5/16	05E-605 ^a		1/2-20	2.07	1.19	.22	1/2	5/8
5/16	3/8	05E-606	05ER-606	9/16-18	2.12	1.19	.22	9/16	11/16
3/8	3/8	06E-606		9/16-18	2.19	1.25	.27	9/16	11/16
3/8	1/2	06E-608 ^a		3/4-16	2.30	1.38	.27	3/4	7/8
1/2	1/2	08E-608 ^a	08ER-608	3/4-16	2.39	1.38	.38	3/4	7/8
1/2	5/8	08E-610 ^a		7/8-14	2.51	1.50	.38	7/8	1
3/4	3/4	12E-612		1-1/16-12	2.76	1.56	.61	1	1-1/4
1	1	16E-616		1-5/16-12	3.05	1.75	.84	1-1/4	1-1/2

^a Swivel nuts are universal — both SAE 37° and 45° connections.

SAE 45° Female swivel

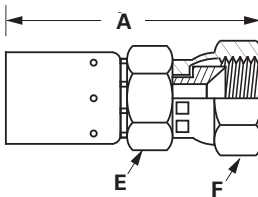

Hose I.D.	Tube size	Part number	Thread size	A	Hose cut-off factor	Hole dia.	Hex E	Hex F
5/16	3/8	05E-406	5/8-18	2.03	1.13	.22	9/16	3/4
3/8	3/8	06E-406	5/8-18	2.06	1.13	.27	9/16	3/4
3/4	3/4	12E-412	1-1/16-14	2.76	1.56	.61	1	1-1/4

British Standard (BSPP) 60° cone female pipe swivel

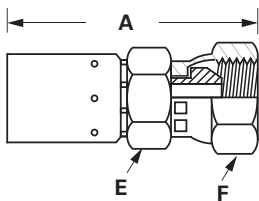

Hose I.D.	Tube size	Part number	Thread size	A	Hose cut-off factor	Hole dia.	Hex E	Hex F
3/16	1/4	03E-354	G-1/4-19*	2.01	1.19	.16	9/16	11/16
1/4	1/4	04E-354	G-1/4-19*	2.07	1.25	.16	9/16	3/4
3/8	3/8	06E-356	G-3/8-19*	2.09	1.13	.27	3/4	7/8
3/8	1/2	06E-358	G-1/2-14*	2.47	1.50	.27	13/16	1
1/2	1/2	08E-358	G-1/2-14*	2.56	1.50	.39	13/16	1
1/2	5/8	08E-360	G-5/8-14*	2.70	1.63	.39	7/8	1-3/16
3/4	3/4	12E-362	G-3/4-14*	2.94	1.69	.61	1	1-1/4
1	1	16E-366	G-1-11*	3.38	2.00	.84	1-1/4	1-1/2

*G as part of thread size is ISO designation for parallel thread.

Female swivel JIS 30° flare parallel pipe swivel

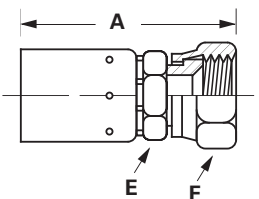

Hose I.D.	Tube size	Part number	Thread size	A	Hose cut-off factor	Hole dia.	Hex E	Hex F
1/4	1/4	04E-04L	G-1/4-19*	2.03	1.19	.16	9/16	3/4
3/8	3/8	06E-06L	G-3/8-19*	2.22	1.25	.27	11/16	7/8
1/2	1/2	08E-08L	G-1/2-14*	2.30	1.25	.39	13/16	1-1/16
3/4	3/4	12E-12L	G-3/4-14*	2.75	1.50	.81	1	1-5/16
1	1	16E-16L	G-1-11*	3.15	1.81	.84	1-1/4	1-1/2

*G as part of thread size is ISO designation for parallel thread.

To determine the correct length of hose, subtract the cut-off factor for each end fitting from the overall length of assembly.

'E' series

Female ORS swivel straight

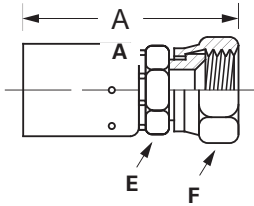

Hose I.D.	Tube size	Carbon steel part number	Stainless steel part number	Thread size	A	Hose cut-off factor	Hole dia.	Hex E	Hex F
5/16	3/8	05E-J66	05ER-J66	11/16-16	2.06	0.93	0.22	11/16	13/16
1/2	1/2	08E-J68	08ER-J68	13/16-16	2.43	1.04	0.36	13/16	15/16

Female ORS swivel straight

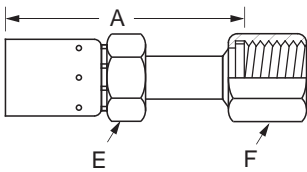

Hose I.D.	Tube size	Part number	Thread size	A	Hose cut-off factor	Hole dia.	Hex E	Hex F
1/4	1/4	04E-S64	9/16-18	2.14	1.31	.15	5/8	11/16
1/4	3/8	04E-S66	11/16-16	2.20	1.38	.16	5/8	13/16
5/16	3/8	05E-S66	11/16-16	2.28	1.38	.22	9/16	13/16
3/8	3/8	06E-S66	11/16-16	2.37	1.44	.24	9/16	13/16
3/8	1/2	06E-S68	13/16-16	2.65	1.69	.24	5/8	15/16
1/2	1/2	08E-S68	13/16-16	2.74	1.69	.33	3/4	15/16
1/2	5/8	08E-S70	1-14	2.83	1.81	.39	3/4	1-1/8
3/4	3/4	12E-S72	1-3/16-12	3.10	1.88	.59	1	1-3/8
1	1	16E-S76	1-7/16-12	3.76	2.44	.78	1-1/4	1-5/8

Compatible air brake nuts & sleeves (order separately)

Straight tube — Brass

(For use with H243 PTFE hose Only)

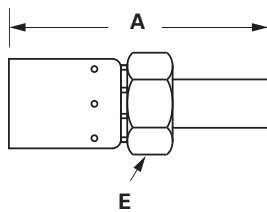

Hose I.D.	Tube size	Part number	Thread size	A	Hose cut-off factor	Hole dia.	Hex E	Tube size	Part number sleeve	Part number nut
1/2	1/2	08E-T58	3.32	2.31	.39	3/4		1/2	1360x8	1361x8
1/2	5/8	08E-T60	3.45	2.44	.47	3/4		5/8	1360x10	1361x10
3/4	5/8	12E-T60	3.66	2.44	.47	1		3/4	1360x12	1361x12
3/4	3/4	12E-T62	4.00	2.81	.61	1				

Insert — Brass
Collar — Steel

WARNING: California Proposition 65, see page A-2.

Compressor discharge Flange end — GM bus only

(For use with H243 PTFE hose Only)

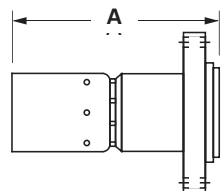

Hose I.D.	Part number	A	Hose cut-off factor	Hole dia.
3/4	12E-X92	2.64	1.38	.61

Note: Part will not crimp in T-420 press.

Crimp fittings

'E' series

To determine the correct length of hose, subtract the cut-off factor for each end fitting from the overall length of assembly.

H

'E' series

Inverted male swivel 45° tube elbow

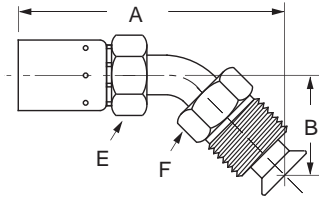

Hose I.D.	Tube size	Part number	Thread size	A	B	Hose cut-off factor	Hole dia.	Hex E	Hex F
1/4	3/16	04E-B43	3/8-24	2.82	.69	2.00	.12	7/16	3/8
1/4	1/4	04E-B44	7/16-24	2.94	.93	2.13	.15	7/16	7/16
3/8	5/16	06E-B45	1/2-20	3.37	1.14	2.44	.21	9/16	1/2
3/8	3/8	06E-B46	5/8-18	3.63	1.34	2.69	.24	5/8	5/8
1/2	1/2	08E-B48	3/4-18	4.32	1.58	3.25	.33	3/4	3/4
1/2	5/8	08E-B50	7/8-18	4.45	1.75	3.44	.39	3/4	7/8

JIC 37° Female swivel 45° tube elbow

(Exceptions noted)

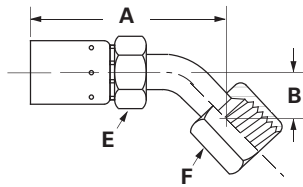

Hose I.D.	Tube size	Part number	Thread size	A	B	Hose cut-off factor	Hole dia.	Hex E	Hex F
1/4	1/4	04E-684 ^a	7/16-20	2.37	.33	1.56	.15	7/16	9/16
1/4	5/16	04E-685 ^a	1/2-20	2.50	.36	1.63	.16	7/16	5/8
5/16	3/8	05E-686	9/16-18	2.65	.39	1.69	.22	9/16	11/16
3/8	3/8	06E-686	9/16-18	2.74	.39	1.75	.24	5/8	11/16
3/8	1/2	06E-688 ^a	3/4-16	2.99	.56	2.00	.27	5/8	7/8
1/2	1/2	08E-688 ^a	3/4-16	2.88	.56	1.78	.33	3/4	7/8
1/2	5/8	08E-690 ^a	7/8-14	3.28	.63	2.25	.39	3/4	1
3/4	3/4	12E-692	1-1/16-12	3.72	.78	2.38	.58	1	1-1/4
1	1	16E-696	1-5/16-12	4.67	1.10	3.31	.83	1-1/4	1-1/2

^a Swivel nuts are universal — both SAE 37° and 45° connections.

Female ORS swivel 45° tube elbow

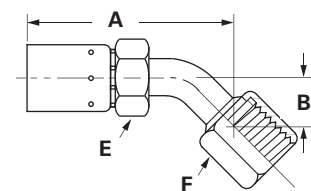

Hose I.D.	Tube size	Part number	Thread size	A	B	Hose cut-off factor	Hole dia.	Hex E	Hex F
1/4	1/4	04E-L64	9/16-18	2.46	.41	1.63	.15	7/16	11/16
1/4	3/8	04E-L66	11/16-16	2.69	.43	1.75	.15	5/8	13/16
5/16	3/8	05E-L66	11/16-16	2.70	.43	1.75	.22	9/16	13/16
3/8	3/8	06E-L66	11/16-16	2.79	.43	1.81	.24	5/8	13/16
1/2	1/2	08E-L68	13/16-16	3.14	.60	2.13	.33	3/4	15/16
3/4	3/4	12E-L72	1-3/16-12	3.83	.83	2.63	.59	1	1-3/8
1	1	16E-L76	1-7/16-12	4.31	.94	3.00	.76	1-1/4	1-5/8

Inverted male swivel 90° tube elbow

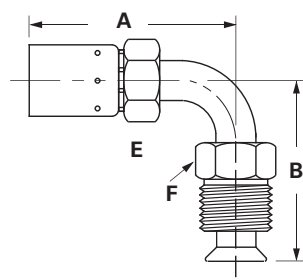

Hose I.D.	Tube size	Part number	Thread size	A	B	Hose cut-off factor	Hole dia.	Hex E	Hex F
1/4	3/16	04E-B63	3/8-24	2.23	1.06	1.38	.12	7/16	3/8
1/4	1/4	04E-B64	7/16-24	2.25	1.36	1.31	.15	7/16	7/16
3/8	5/16	06E-B65	1/2-20	2.49	1.61	1.56	.21	9/16	1/2
3/8	3/8	06E-B66	5/8-18	2.92	1.97	1.94	.24	5/8	5/8
1/2	1/2	08E-B68	3/4-18	3.03	2.32	2.00	.33	3/4	3/4

To determine the correct length of hose, subtract the cut-off factor for each end fitting from the overall length of assembly.

'E' series

JIC 37° Female swivel 90° tube elbow

(Exceptions noted)

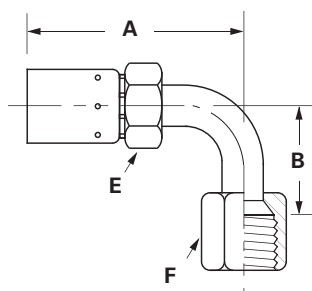

Hose I.D.	Tube size	Part number	Thread size	A	B	Hose cut-off factor	Hole dia.	Hex E	Hex F
1/4	1/4	04E-664 ^a	7/16-20	2.27	.68	1.44	.15	7/16	9/16
1/4	5/16	04E-665 ^a	1/2-20	2.47	.77	1.63	.16	7/16	5/8
5/16	5/16	05E-665 ^a	1/2-20	2.58	.77	1.63	.21	9/16	5/8
5/16	3/8	05E-666	9/16-18	2.57	.85	1.62	.22	9/16	11/16
3/8	3/8	06E-666	9/16-18	2.63	.85	1.68	.24	5/8	11/16
3/8	1/2	06E-668 ^a	3/4-16	2.76	1.09	1.81	.27	5/8	7/8
1/2	1/2	08E-668 ^a	3/4-16	2.82	1.09	1.75	.33	3/4	7/8
1/2	5/8	08E-670 ^a	7/8-14	3.34	1.23	2.31	.39	3/4	1
3/4	3/4	12E-672	1-1/16-12	3.70	1.82	2.50	.59	1	1-1/4
1	1	16E-676	1-5/16-12	4.39	2.14	3.00	.83	1-1/4	1-1/2

^a Swivel nuts are universal — both SAE 37° and 45° connections.

SAE 45° Female swivel 90° tube elbow

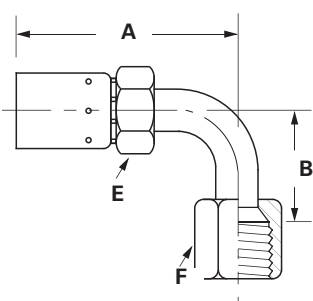

Hose I.D.	Tube size	Part number	Thread size	A	B	Hose cut-off factor	Hole dia.	Hex E	Hex F
3/8	3/8	06E-466	5/8-18	2.72	.85	1.75	.24	5/8	3/4

JIC 37° Female swivel long drop 90° tube elbow

(Exceptions noted)

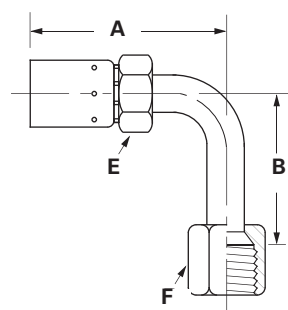

Hose I.D.	Tube size	Part number	Thread size	A	B	Hose cut-off factor	Hole dia.	Hex E	Hex F
1/4	1/4	04E-644 ^a	7/16-20	2.27	1.80	1.42	.15	7/16	9/16
1/4	5/16	04E-645 ^a	1/2-20	2.51	1.80	1.63	.16	7/16	5/8
5/16	3/8	05E-646	9/16-18	2.63	2.18	1.69	.22	9/16	11/16
3/8	3/8	06E-646	9/16-18	2.66	2.18	1.69	.24	5/8	11/16
3/8	1/2	06E-648 ^a	3/4-16	2.83	2.43	1.88	.27	5/8	7/8
1/2	1/2	08E-648 ^a	3/4-16	2.82	2.43	1.75	.33	3/4	7/8
1/2	5/8	08E-650 ^a	7/8-14	2.96	2.57	1.94	.39	3/4	1
3/4	3/4	12E-652	1-1/16-12	3.74	3.73	2.50	.58	1	1-1/4
1	1	16E-656	1-5/16-12	4.36	4.33	3.00	.83	1-1/4	1-1/2

^a Swivel nuts are universal — both SAE 37° and 45° connections.

Crimp fittings

'E' series

To determine the correct length of hose, subtract the cut-off factor for each end fitting from the overall length of assembly.

H

'E' series

British Standard (BSPP) 60° cone female pipe swivel 90° elbow

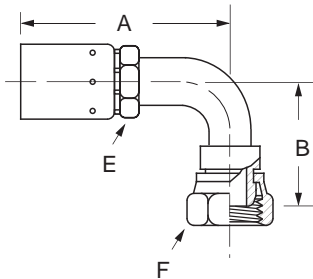

Hose I.D.	BSPP pipe size	Part number	Thread size	A	B	Hose cut-off factor	Hole dia.	Hex E	Hex F
1/4	1/4	04E-74P	G-1/4-19*	2.89	1.50	2.06	.16	7/16	3/4
3/8	3/8	06E-76P	G-3/8-19*	2.96	1.66	2.00	.27	5/8	7/8
1/2	1/2	08E-78P	G-1/2-14*	2.95	1.73	1.88	.37	3/4	1
3/4	3/4	12E-82P	G-3/4-14*	3.83	2.43	2.61	.61	1	1-1/4

*G as part of thread size is ISO designation for parallel thread.

Female ORS swivel short drop 90° elbow

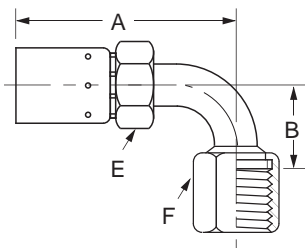

Hose I.D.	Tube size	Part number	Thread size	A	B	Hose cut-off factor	Hole dia.	Hex E	Hex F
1/4	1/4	04E-A24	9/16-18	2.27	.81	1.44	.21	7/16	11/16
1/4	3/8	04E-A26	11/16-16	2.54	.90	1.69	.16	5/8	13/16
5/16	3/8	05E-A26	11/16-16	2.62	.90	1.69	.22	9/16	13/16
3/8	3/8	06E-A26	11/16-16	2.71	.90	1.75	.24	5/8	13/16
3/8	1/2	06E-A28	13/16-16	2.81	1.15	1.88	.27	5/8	15/16
1/2	1/2	08E-A28	13/16-16	2.90	1.15	1.88	.33	3/4	15/16
3/4	3/4	12E-A32	1-3/16-12	3.70	1.88	2.50	.59	1	1-3/8
1	1	16E-A36	1-7/16-12	4.01	2.21	2.69	.76	1-1/4	1-5/8

Female ORS swivel long drop 90° tube elbow

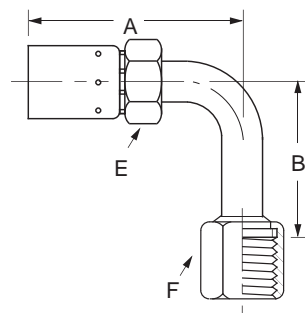

Hose I.D.	Tube size	Part number	Thread size	A	B	Hose cut-off factor	Hole dia.	Hex E	Hex F
1/4	1/4	04E-A64	9/16-18	2.41	1.80	1.56	.21	7/16	11/16
5/16	3/8	05E-A66	11/16-16	2.73	2.12	1.81	.22	9/16	13/16
3/8	3/8	06E-A66	11/16-16	2.82	2.12	1.88	.24	5/8	13/16
3/8	1/2	06E-A68	13/16-16	2.80	2.50	1.88	.27	5/8	15/16
1/2	1/2	08E-A68	13/16-16	2.89	2.50	1.88	.33	3/4	15/16

To determine the correct length of hose, subtract the cut-off factor for each end fitting from the overall length of assembly.

Crimp fittings

069 'E' series

H

069 'E' series

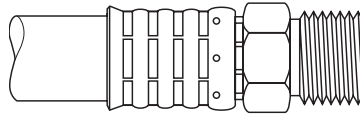

Ordering information: Order individually by part number.

 Refer to important safety information on page A-2.

Compatible hose: H059, H069, H166, H169, H229, H239, H366, H569

Pressure: Determined by maximum working pressure for hose size and hose end configuration whichever is lesser. See pages A-24-25 for

working pressure ratings for hose end configurations.

Material: Low carbon steel

Plating: Zinc; clear trivalent chromate

Assemble with: T-400-1, T-410-1, T-420-1, T-440-1, T-460, T-462, T-465-1, T-480, ET4000, ET4001.

Label set: FS-1500

Application: General purpose low- and medium-pressure hydraulics. Generally used for truck and off-road vehicle applications.

Advantages: Wide selection of hose and end configurations allowing for a diverse number of applications. Limited competition and economical cost.

Male pipe rigid

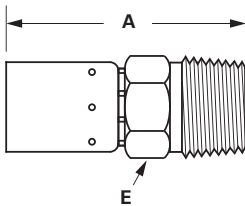

Hose I.D.	Tube size	Part number	Thread size	A	Hose cut-off factor	Hole dia.	Hex E
3/16	1/8	06904E-102	1/8-27	1.70	.75	.13	7/16
3/16	1/4	06904E-104	1/4-18	1.88	1.00	.13	9/16
1/4	1/4	06905E-104	1/4-18	1.88	1.00	.18	9/16
5/16	1/4	06906E-104	1/4-18	2.04	1.00	.24	5/8
5/16	3/8	06906E-106	3/8-18	2.03	1.00	.24	11/16
13/32	3/8	06908E-106	3/8-18	2.04	1.00	.31	3/4
13/32	1/2	06908E-108	1/2-14	2.29	1.25	.31	7/8
1/2	1/2	06910E-108	1/2-14	2.41	1.38	.39	7/8
1/2	3/4	06910E-112	3/4-14	2.47	1.38	.39	1-1/16
5/8	3/4	06912E-112	3/4-14	2.52	1.25	.51	1-1/16
7/8	3/4	06916E-112	3/4-14	2.69	1.44	.71	1-1/8
7/8	1	06916E-116	1-11-1/2	2.88	1.63	.75	1-3/8
1-1/8	1-1/4	06920E-120	1-1/4-11-1/2	3.06	1.69	1.00	1-11/16
1-3/8	1-1/2	06924E-124	1-1/2-11-1/2	3.37	2.00	1.25	2
1-13/16	2	06932E-132	2-11-1/2	3.38	2.00	1.63	2-1/2

JIC 37° Male rigid

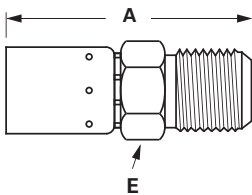

Hose I.D.	Tube size	Part number	Thread size	A	Hose cut-off factor	Hole dia.	Hex E
3/16	1/4	06904E-504	7/16-20	1.87	1.00	.13	1/2
1/4	5/16	06905E-505	1/2-20	1.87	1.00	.18	9/16
5/16	3/8	06906E-506	9/16-18	2.03	1.00	.24	5/8
13/32	1/2	06908E-508	3/4-16	2.19	1.19	.31	13/16
1/2	5/8	06910E-510	7/8-14	2.43	1.25	.39	15/16
5/8	3/4	06912E-512	1-1/16-12	2.63	1.38	.51	1-1/8
7/8	1	06916E-516	1-5/16-12	2.85	1.50	.75	1-3/8
1-1/8	1-1/4	06920E-520	1-5/8-12	3.06	1.63	1.00	1-11/16
1-3/8	1-1/2	06924E-524	1-7/8-12	3.17	1.81	1.25	2

Crimp fittings

069 'E' series

To determine the correct length of hose, subtract the cut-off factor for each end fitting from the overall length of assembly.

H

069 'E' series

Inverted male swivel straight

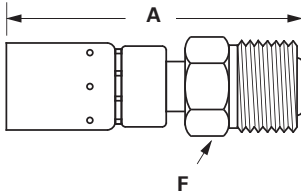

Hose I.D.	Tube size	Part number	Thread size	A	Hose cut-off factor	Hole dia.	Hex F
3/16	1/4	06904E-B04	7/16-24	2.58	1.56	.13	7/16
1/4	5/16	06905E-B05	1/2-20	2.63	1.63	.18	1/2
5/16	3/8	06906E-B06	5/8-18	2.87	1.78	.24	5/8
13/32	1/2	06908E-B08	3/4-18	3.24	2.06	.31	3/4

JIC 37° female swivel

(Exceptions noted)

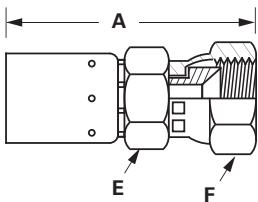

Hose I.D.	Tube size	Part number	Thread size	A	Hose cut-off factor	Hole dia.	Hex E	Hex F
3/16	1/4	06904E-604 ^a	7/16-20	2.01	1.06	.13	7/16	9/16
1/4	5/16	06905E-605 ^a	1/2-20	2.09	1.19	.18	7/16	5/8
5/16	3/8	06906E-606	9/16-18	2.26	1.19	.24	9/16	11/16
5/16	1/2	06906E-608 ^a	3/4-16	2.41	1.31	.24	3/4	7/8
13/32	1/2	06908E-608 ^a	3/4-16	2.41	1.38	.31	3/4	7/8
1/2	1/2	06910E-608 ^a	3/4-16	2.53	1.44	.39	13/16	7/8
1/2	5/8	06910E-610 ^a	7/8-14	2.62	1.50	.39	13/16	1
5/8	3/4	06912E-612	1-1/16-12	2.77	1.50	.51	1	1-1/4
7/8	1	06916E-616	1-5/16-12	3.11	1.75	.75	1-1/4	1-1/2
1-1/8	1-1/4	06920E-620	1-5/8-12	3.30	1.81	1.00	1-9/16	2
1-3/8	1-1/2	06924E-624	1-7/8-12	3.45	2.13	1.25	2	2-1/4
1-13/16	2	06932E-632	2-1/2-12	4.15	2.81	1.63	2-1/2	3

^a Swivel nuts are universal — both SAE 37° and 45° connections.

SAE 45° female swivel

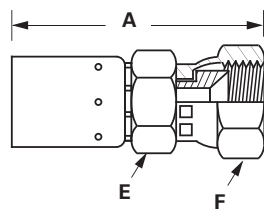

Hose I.D.	Tube size	Part number	Thread size	A	Hose cut-off factor	Hole dia.	Hex E	Hex F
5/16	3/8	06906E-406	5/8-18	2.18	1.13	.24	9/16	3/4
5/8	3/4	06912E-412	1-1/16-14	2.81	1.50	.51	1	1-1/4

30° flare female swivel

(PTT thread for diesel applications)

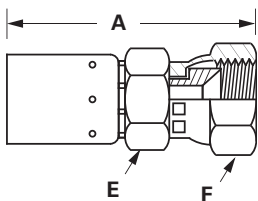

Hose I.D.	Tube size	Part number	Thread size	A	Hose cut-off factor	Hole dia.	Hex E	Hex F
7/8	1	06916E-X26	1-5/16-14	2.96	1.69	.75	1-1/4	1-1/2

To determine the correct length of hose, subtract the cut-off factor for each end fitting from the overall length of assembly

069 'E' series

Female swivel 30° flare

(Komatsu, Linkbelt)

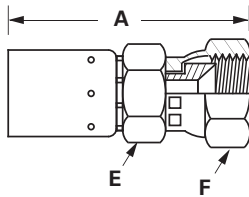

Hose I.D.	Part number	Thread size	A	Hose cut-off factor	Hole dia.	Hex E	Hex F
5/16	06906E-18K	M18x1.5	2.38	1.31	.24	3/4	7/8
1/2	06910E-22K	M22x1.5	2.65	1.56	.39	13/16	1
5/8	06912E-24K	M24x1.5	2.88	1.58	.48	1	1-1/4
5/8	06912E-30K	M30x1.5	3.26	1.96	.52	1-1/16	36mm
7/8	06916E-33K	M33x1.5	3.11	1.82	.75	1-1/4	1-1/2
1-3/8	06924E-42K	M42x1.5	3.55	2.17	1.19	2	2-1/8

Inverted male swivel 45° tube elbow

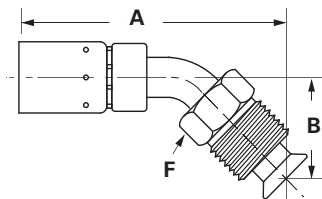

Hose I.D.	Tube size	Part number	Thread size	A	B	Hose cut-off factor	Hole dia.	Hex F
3/16	1/4	06904E-E44	7/16-24	3.08	.93	2.06	.12	7/16
1/4	5/16	06905E-E45	1/2-20	3.42	1.14	2.44	.18	1/2
5/16	3/8	06906E-E46	5/8-18	3.65	1.34	2.56	.21	5/8

JIC 37° female swivel 45° tube elbow

(Exceptions noted)

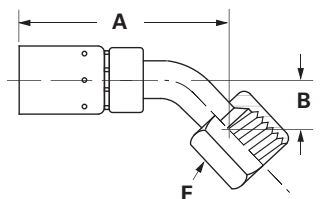

Hose I.D.	Tube size	Part number	Thread size	A	B	Hose cut-off factor	Hole dia.	Hex F
3/16	1/4	06904E-684 ^a	7/16-20	2.50	.33	1.50	.13	9/16
1/4	5/16	06905E-685 ^a	1/2-20	2.63	.36	1.63	.18	5/8
5/16	3/8	06906E-686	9/16-18	2.78	.38	1.69	.24	11/16
13/32	1/2	06908E-688 ^a	3/4-16	3.07	.55	1.83	.31	7/8
1/2	5/8	06910E-690 ^a	7/8-14	3.39	.63	2.31	.45	1
5/8	3/4	06912E-692	1-1/16-12	3.70	.78	2.38	.52	1-1/4
7/8	1	06916E-696	1-5/16-12	4.68	1.10	3.38	.75	1-1/2

^a Swivel nuts are universal — both SAE 37° and 45° connections.

SAE 45° female swivel 45° tube elbow

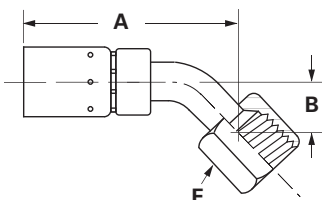

Hose I.D.	Tube size	Part number	Thread size	A	B	Hose cut-off factor	Hole dia.	Hex F
5/16	3/8	06906E-486	5/8-18	2.77	.39	1.69	.24	3/4
5/8	3/4	06912E-492	1-1/16-14	3.74	.78	2.44	.52	1-1/4

Crimp fittings

069 'E' series

To determine the correct length of hose, subtract the cut-off factor for each end fitting from the overall length of assembly.

H

069 'E' series

Inverted Male swivel 90° tube elbow

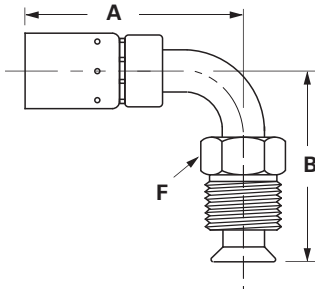

Hose I.D.	Tube size	Part number	Thread size	A	B	Hose cut-off factor	Hole dia.	Hex F
3/16	1/4	06904E-E04	7/16-24	2.31	1.36	1.25	.13	7/16
1/4	5/16	06905E-E05	1/2-20	2.59	1.61	1.56	.18	1/2
5/16	1/4	06906E-E04	7/16-24	2.43	1.36	1.31	.15	7/16
5/16	5/16	06906E-E05	1/2-20	2.66	1.61	1.56	.21	1/2
5/16	3/8	06906E-E06	5/8-18	2.94	1.97	1.85	.24	5/8
1/2	5/8	06910E-E10	7/8-18	3.27	2.58	2.30	.39	7/8

JIC 37° Female swivel 90° tube elbow

(Exceptions noted)

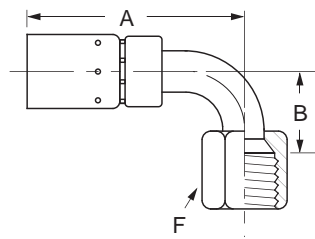

Hose I.D.	Tube size	Part number	Thread size	A	B	Hose cut-off factor	Hole dia.	Hex F
3/16	1/4	06904E-664 ^a	7/16-20	2.41	.68	1.38	.13	9/16
1/4	5/16	06905E-665 ^a	1/2-20	2.62	.77	1.63	.21	5/8
5/16	3/8	06906E-666	9/16-18	2.73	.85	1.78	.24	11/16
13/32	1/2	06908E-668 ^a	3/4-16	2.87	1.09	1.75	.31	7/8
1/2	5/8	06910E-670 ^a	7/8-14	3.52	1.23	2.44	.39	1
5/8	3/4	06912E-672	1-1/16-12	3.66	1.82	2.31	.58	1-1/4
7/8	1	06916E-676	1-5/16-12	4.40	2.14	3.13	.76	1-1/2
1-1/8	1-1/4 *	06920E-657 [†]	1-5/8-12	4.32	5.38	2.90	1.00	2
1-1/8	1-1/4 *	06920E-677	1-5/8-12	4.27	3.25	2.90	1.01	2
1-3/8	1-1/2 *	06924E-678	1-7/8-12	4.09	3.05	2.70	1.25	2-1/2

* 20 and 24 size ends have crimped nuts.

[†] Long drop elbow.

^a Swivel nuts are universal — both SAE 37° and 45° connections.

SAE 45° Female swivel 90° tube elbow

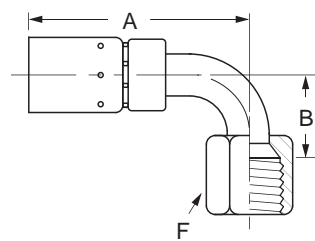

Hose I.D.	Tube size	Part number	Thread size	A	B	Hose cut-off factor	Hole dia.	Hex F
5/16	3/8	06906E-466	5/8-18	2.76	.85	1.56	.24	3/4
5/8	3/4	06912E-472	1-1/16-14	3.64	1.82	2.31	.52	1-1/4

327 'E' series

Ordering Information: Order individually part number.

 Refer to important safety information on page A-2.

Compatible hose
GH100

Pressure: Determined by working pressure for hose and hose size.

Material: Low carbon steel

Plating: Clear trivalent chromate

Assemble with: ET1000, ET4000, ET4001, T-400-1, T-410-1, T-420-1, T-440-1, T-460, T-462, T-465-1, T480, ET1187, ET1380, FT1390, ET5040, ET5050.

Label set: FS-1200

Application: General purpose low- and medium-pressure hydraulics.

Note: Refer to current price list for availability of cataloged items. Configurations and dimensions subject to change without notice.

To determine the correct length of hose, subtract the cut-off factor for each end fitting from the overall length of assembly.

Female JIC, SAE 37° swivel

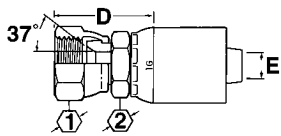

Hose I.D.	Tube size	Part number	Thread size	A	Hose cut-off factor	Hole dia.	Hex E	Hex F
6	6	32706E-606	9/16-18	2.19	1.19	0.26	11/16	11/16
8	8	32708E-608	3/4-16	2.63	1.46	0.38	7/8	13/16
10	10	32710E-610	7/8-14	2.77	1.61	0.5	1	15/16
12	12	32712E-612	1 1/6-12	2.84	1.65	0.61	1 1/4	1 1/8

Female JIC/SAE 37° swivel 45° tube elbow

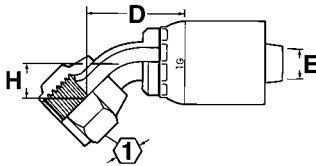

Hose I.D.	Tube size	Part number	Thread size	A	H	Hose cut-off factor	Hole dia.	Hex
6	6	32706E-686	9/16-18	2.31	0.39	1.31	.24	11/16
8	8	32708E-688	3/4-16	2.82	0.55	1.65	.37	7/8
10	10	32710E-690	7/8-14	2.94	0.59	1.79	.46	1
12	12	32712E-692	1 1/6-12	3.43	0.78	2.24	.58	1 1/4

Female JIC/SAE 37° swivel 90° tube elbow

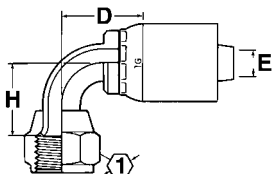

Hose I.D.	Tube size	Part number	Thread size	A	H	Hose cut-off factor	Hole dia.	Hex
6	6	32706E-666	9/16-18	2.21	0.84	1.22	.24	11/16
8	8	32708E-668	3/4-16	2.59	1.09	1.42	.37	7/8
10	10	32710E-670	7/8-14	2.7	1.19	1.55	.46	1
12	12	32712E-672	1 1/6-12	3.36	1.8	2.17	.58	1 1/4

Crimp fittings

327 'E' series

To determine the correct length of hose, subtract the cut-off factor for each end fitting from the overall length of assembly.

H

327 'E' series

Female ORS

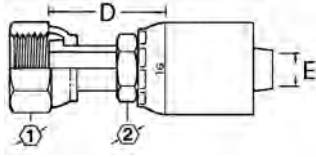

Hose I.D.	Tube size	Part number	Thread size	A	Hose cut-off factor	Hole dia. E	Hex 1	Hex 2
6	6	32706E-S66	11/16-16	2.23	1.24	0.26	13/16	11/16
8	8	32708E-S68	13/16-16	2.67	1.5	0.38	15/16	7/8
10	10	32710E-S70	1-14	2.76	1.61	0.48	1 1/8	15/16
12	12	32712E-S72	1 3/16-12	2.91	1.72	0.61	1 3/8	1 -1/8

Female ORS 45° elbow

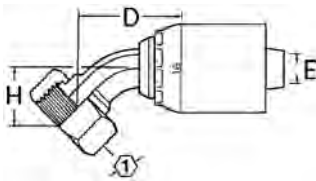

Hose I.D.	Tube size	Part number	Thread size	A	H	Hose cut-off factor	Hole dia.	Hex
6	6	32706E-L66	11/16-16	2.43	0.43	1.43	.26	13/16
8	8	32708E-L68	13/16-16	2.96	0.59	1.79	.36	15/16
12	12	32712E-L72	1 3/16-12	3.57	0.83	2.38	.55	1 3/8

Female ORS 90° Elbow

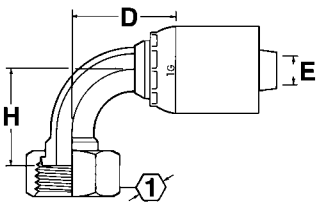

Hose I.D.	Tube size	Part number	Thread size	A	H	Hose cut-off factor	Hole dia.	Hex
6	6	32706E-A26	11/16-16	2.34	0.9	1.34	.26	13/16
8	8	32708E-A28	13/16-16	2.84	1.15	1.67	.36	15/16
12	12	32710E-A30	1 3/16-12	3.49	1.88	2.3	.55	1 3/8

757 'E' series

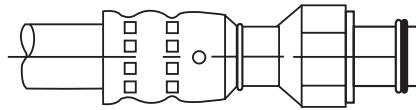

Ordering information: Order individually by catalog number.

 Refer to important safety information on page A-2.

Compatible hose: H757

Pressure: Determined by hose burst pressure. See pages A-24-25 for operating pressure ratings for hose end configurations.

Material: Carbon steel

Plating: Zinc; clear trivalent chromate

Assemble with: T-400-1, T-410-1, T-420-1, T-440-1, T-460, T-462, T-465-1, T-475-1, T-480, ET4000

Label set: FS-3200

Note: Refer to current price list for availability of cataloged items. Configurations and dimensions subject to change without notice.

Applications:

Used with R134a and R12 applications. Ideal for heavy duty truck use as well as industrial and automotive applications.

Advantages: Wide selection of hose ends which include the flareless ends, allowing use of existing tubing. Steel hose ends handle heavy duty demands.

To determine the correct length of hose, subtract the cut-off factor for each end fitting from the overall length of assembly.

757 'E' series air conditioning procedure

The crimp machine system can be used to make original equipment assemblies using factory replacement ends. If the required hose end is not found, our Flareless hose end can be used. By following the instructions on this page, a new hose assembly can be made by combining Weatherhead hose end with the original equipment end configuration.

- Typical original equipment assembly
- Typical assembly of a flareless hose end used with an old original equipment end configuration
- Weatherhead replacement assemblies using original equipment tubing with Weatherhead 757 'E' Series hose ends

Preparation – Flareless tube assembly

1. Remove the bad tube assembly or if room permits, perform the cutting procedure in place. Cut the tube squarely and as close to the hose connection as possible. Allow an adequate straight area for the flareless nut and sleeve to move freely for installation purposes. Deburr the inside and outside diameters of the tubing.

Make presetting operation

1. Slide nut and then sleeve onto tube. Shoulder of sleeve must be toward nut.
2. Lubricate threads, seat in hose end, and flareless sleeve with a good grade of lubricant. Insert tube into seat of hose end, making sure that tube is bottomed, **TIGHTEN HAND TIGHT** and then tighten an **ADDITIONAL 1 to 1-1/6 turns** with a wrench.

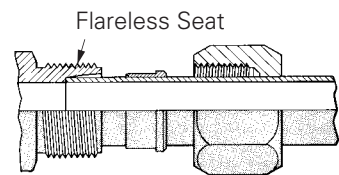
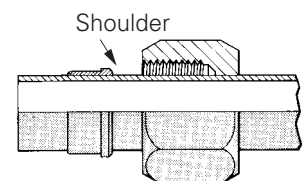
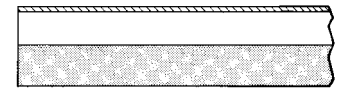
**Note:**

Compensate for tubing being removed by adding to the overall length of the replacement hose assembly.

Crimp fittings

757 'E' series

To determine the correct length of hose, subtract the cut-off factor for each end fitting from the overall length of assembly. All dimensions shown in inches.

H

757 'E' series

Bumped tube O-Ring Male rigid

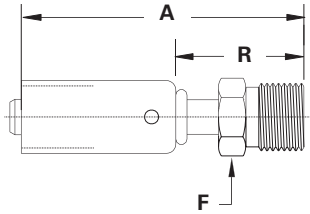

Hose I.D.	Tube size	Part number	Thread size	Length A	Run R	Hose cut-off factor	Hex F
5/16	3/8	75706E-W06	5/8-18	2.94	1.54	1.63	5/8
13/32	1/2	75708E-W08	3/4-16	3.26	1.86	2.00	3/4
1/2	5/8	75710E-W10	7/8-14	3.35	1.95	2.13	7/8
5/8	5/8	75712E-W10	7/8-14	3.56	2.06	2.25	7/8
5/8	3/4	75712E-W12	1-1/16-14	3.56	2.06	2.25	1-1/16

Bumped tube O-Ring Male swivel

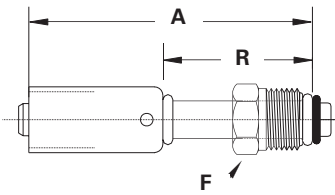

Hose I.D.	Tube size	Part number	Thread size	Length A	Run R	Hose cut-off factor	Hex F	O-Ring
5/16	3/8	75706E-Z06	5/8-18	2.94	1.54	1.63	5/8	ZW74706
5/16	1/2	75706E-Z08	3/4-18	3.15	1.75	1.88	3/4	ZW74708
13/32	1/2	75708E-Z08	3/4-18	3.26	1.86	2.00	3/4	ZW74708
1/2	5/8	75710E-Z10	7/8-18	3.35	1.95	2.13	7/8	ZW74710
1/2	3/4	75710E-Z12	1-1/16-16	3.46	2.06	2.25	1-1/16	ZW74712
5/8	5/8	75712E-Z10	7/8-18	3.56	2.06	2.25	7/8	ZW74710
5/8	3/4	75712E-Z12	1-1/16-16	3.56	2.06	2.25	1-1/16	ZW74712

(Includes o-ring).

Male rigid compression fitting (with nut and sleeve)

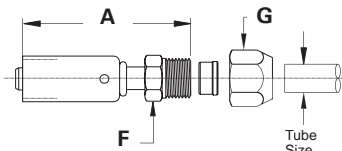

Hose I.D.	Tube size	Part number	Thread size	Length A	Hose cut-off factor	Hex F	Hex G
5/16	3/8	75706E-756	5/8-18	2.59	1.38	5/8	3/4
5/16	1/2	75706E-758	3/4-16	2.71	1.50	3/4	7/8
13/32	3/8	75708E-756	5/8-18	2.65	1.38	5/8	3/4
13/32	1/2	75708E-758	3/4-16	2.78	1.50	3/4	7/8
13/32	5/8	75708E-760	7/8-14	2.90	1.63	7/8	1-1/16
1/2	1/2	75710E-758	3/4-16	2.84	1.63	3/4	7/8
1/2	5/8	75710E-760	7/8-14	2.90	1.63	7/8	1-1/16
5/8	5/8	75712E-760	7/8-14	3.13	1.75	7/8	1-1/16
5/8	3/4	75712E-762	1-1/16-14	3.25	1.88	1-1/16	1-1/4

Flareless - see page H-15 for assembly instructions

SAE 45° Male rigid

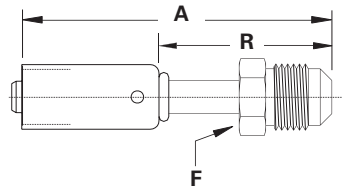

Hose I.D.	Tube size	Part number	Thread size	Length A	Run R	Hose cut-off factor	Hex F
5/16	3/8	75706E-306	5/8-18	3.28	1.88	2.00	5/8
13/32	1/2	75708E-308	3/4-16	3.40	2.00	2.13	3/4
1/2	5/8	75710E-310	7/8-14	3.71	2.31	2.50	7/8
5/8	3/4	75712E-312	1-1/16-14	4.00	2.50	2.75	1-1/16

To determine the correct length of hose, subtract the cut-off factor for each end fitting from the overall length of assembly. All dimensions shown in inches.

757 'E' series

Bumped tube O-Ring Female swivel

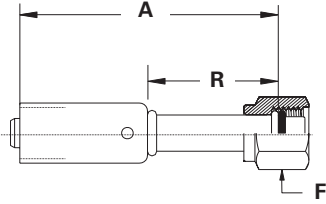

Hose I.D.	Tube size	Part number	Thread size	Length A	Run R	Hose cut-off factor	Hex F	O-Ring
5/16	3/8	75706E-Z47	5/8-18	2.78	1.38	1.50	3/4	ZW74706
5/16	1/2	75706E-Z49	3/4-16	2.90	1.50	1.63	7/8	ZW74708
13/32	1/2	75708E-Z49	3/4-16	3.06	1.66	1.75	7/8	ZW74708
13/32	5/8	75708E-Z51	7/8-14	3.09	1.69	1.88	1-1/16	ZW74710
1/2	5/8	75710E-Z51	7/8-14	3.09	1.69	1.88	1-1/16	ZW74710
1/2	3/4	75710E-Z53	1-1/16-14	3.21	1.81	2.00	1-1/4	ZW74712
5/8	5/8	75712E-Z51	7/8-14	3.31	1.81	2.00	1-1/16	ZW74710
5/8	3/4	75712E-Z53	1-1/16-14	3.31	1.81	2.00	1-1/4	ZW74712

(Includes O-ring).

Bumped tube O-Ring Female swivel W/R134a Service port

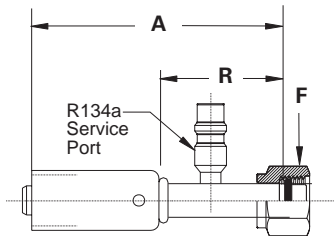

Hose I.D.	Tube size	Part number	Thread size	Length A	Run R	Hose cut-off factor	Hex F	O-Ring
5/16	3/8	75706E-Z57*	5/8-18	4.28	1.88	3.00	3/4	ZW74706
13/32	1/2	75708E-Z59*	3/4-16	4.28	1.88	3.00	7/8	ZW74708
1/2	5/8	75710E-Z61**	7/8-14	4.52	2.12	3.25	1-1/16	ZW74710
5/8	5/8	75712E-Z61**	7/8-14	4.62	3.05	3.25	1-1/16	ZW74710

*High side port
 **Low side port
 (Includes O-ring)

SAE 45° flare female swivel

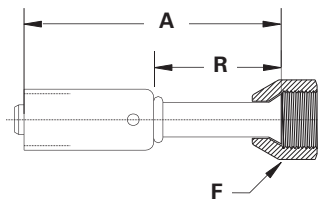

Hose I.D.	Tube size	Part number	Thread size	Length A	Run R	Hose cut-off factor	Hex F
5/16	3/8	75706E-406	5/8-18	2.78	1.38	1.50	3/4
5/16	1/2	75706E-408	3/4-16	2.90	1.50	1.75	7/8
13/32	1/2	75708E-408	3/4-16	2.84	1.44	1.56	7/8
1/2	5/8	75710E-410	7/8-14	3.09	1.69	1.81	1-1/16
5/8	5/8	75712E-410	7/8-14	3.25	1.75	2.00	1-1/16
5/8	3/4	75712E-412	1-1/16-14	3.25	1.75	2.00	1-1/4

Hose splicer

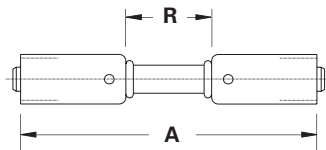

Hose I.D.	Hose I.D.	Part number	Length A	Run R	Hose cut-off factor
5/16	5/16	75706E-Y36	4.30	1.50	1.50
5/16	13/32	75706E-Y38	4.30	1.50	1.50
13/32	13/32	75708E-Y38	4.30	1.50	1.50
13/32	1/2	75708E-Y40	4.43	1.63	1.63
1/2	1/2	75710E-Y40	4.43	1.63	1.63
1/2	5/8	75710E-Y41	4.65	1.75	1.75
5/8	5/8	75712E-Y41	4.75	1.75	1.75

Crimp fittings

757 'E' series

To determine the correct length of hose, subtract the cut-off factor for each end fitting from the overall length of assembly. All dimensions shown in inches.

H

757 'E' series

Hose splicer w/R134a service port

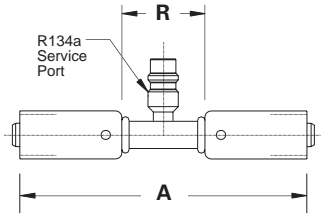

Hose I.D.	Hose I.D.	Part number	Length A	Run R	Hose cut-off factor
5/16	5/16	75706E-Y47*	5.42	2.62	1.50
13/32	13/32	75708E-Y48*	5.42	2.62	1.50
1/2	1/2	75710E-Y49**	5.42	2.62	1.63
5/8	5/8	75712E-Y50**	5.62	2.62	1.75

(For crimping information refer to document W-HOOV-TM001-E2.)

*High side port
**Low side port

SAE 45° flare male rigid 45° tube elbow

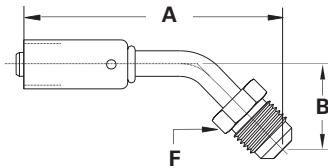

Hose I.D.	Tube size	Part number	Thread size	Length A	Drop B	Hose cut-off factor	Hex F
13/32	1/2	75708E-388	3/4-16	3.65	1.25	2.50	3/4
1/2	5/8	75710E-390	7/8-14	4.21	1.56	3.00	7/8

Bumped tube O-Ring Male swivel 45° tube elbow

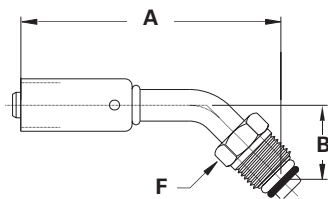

Hose I.D.	Tube size	Part number	Thread size	Length A	Run B	Hose cut-off factor	Hex F	O-Ring
5/16	3/8	75706E-Z26	5/8-18	3.09	0.88	1.88	5/8	ZW74706
13/32	1/2	75708E-Z28	3/4-18	3.59	1.03	2.38	3/4	ZW74708
1/2	5/8	75710E-Z30	7/8-18	3.71	1.06	2.50	7/8	ZW74710
5/8	5/8	75712E-Z30	7/8-18	4.19	1.19	2.88	7/8	ZW74710
5/8	3/4	75712E-Z32	1-1/16-16	4.19	1.19	2.88	1-1/16	ZW74712

(Includes O-ring).

Bumped tube O-Ring Female swivel 45° tube elbow

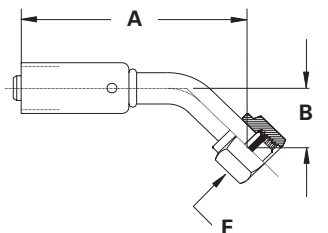

Hose I.D.	Tube size	Part number	Thread size	Length A	Run B	Hose cut-off factor	Hex F	O-Ring
5/16	3/8	75706E-W47	5/8-18	3.51	0.68	2.25	3/4	ZW74706
13/32	1/2	75708E-W49	3/4-16	3.63	1.05	2.25	7/8	ZW74708
1/2	5/8	75710E-W51	7/8-14	3.65	1.19	2.50	1-1/16	ZW74710
5/8	5/8	75712E-W51	7/8-14	4.00	1.29	2.75	1-1/16	ZW74710
5/8	3/4	75712E-W53	1-1/16-14	3.84	0.94	2.50	1-1/4	ZW74712

(Includes O-ring).

To determine the correct length of hose, subtract the cut-off factor for each end fitting from the overall length of assembly. All dimensions shown in inches.

Crimp fittings

757 'E' series

H

757 'E' series

SAE 45° Flare Female swivel 45° tube elbow

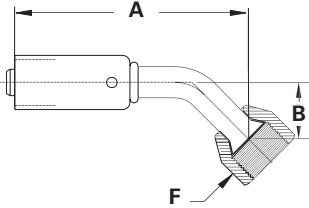

Hose I.D.	Tube size	Part number	Thread size	Length A	Drop B	Hose cut-off factor	Hex F
5/16	3/8	75706E-486	5/8-18	3.42	.55	2.00	3/4
13/32	1/2	75708E-488	3/4-16	3.72	.58	2.50	7/8
1/2	5/8	75710E-490	7/8-14	4.34	.72	3.00	1-1/16
5/8	5/8	75712E-490	7/8-14	5.00	1.00	3.50	1-1/16
5/8	3/4	75712E-492	1-1/16-14	4.44	.72	3.00	1-1/4

SAE 45° Male rigid 90° elbow

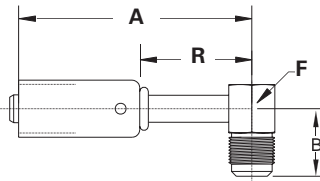

Hose I.D.	Tube size	Part number	Thread size	Length A	Run R	Drop B	Hose cut-off factor	Hex square F
5/16	3/8	75706E-X06	5/8-18	4.07	2.67	.91	3.00	5/8
13/32	1/2	75708E-X08	3/4-16	4.14	2.74	1.47	3.00	7/8
1/2	5/8	75710E-X10	7/8-14	4.25	2.85	1.47	3.00	7/8
5/8	3/4	75712E-X12	1-1/16-14	4.45	2.95	1.56	3.00	1-1/16

Bumped tube O-Ring Male rigid 90° tube elbow

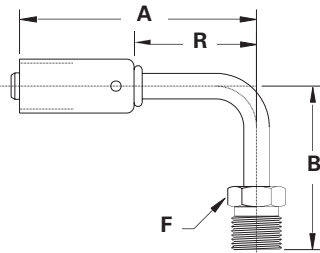

Hose I.D.	Tube size	Part number	Thread size	Length A	Run R	Drop B	Hose cut-off factor	Hex F
5/16	3/8	75706E-W66	5/8-18	4.00	2.60	1.53	2.75	5/8
13/32	1/2	75708E-W68	3/4-16	4.07	2.67	2.12	2.75	3/4
1/2	5/8	75710E-W70	7/8-14	4.15	2.75	2.21	2.88	7/8

Bumped tube O-Ring Male swivel 90° tube elbow

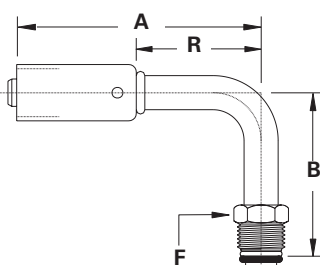

Hose I.D.	Tube size	Part number	Thread size	Length A	Run R	Drop B	Hose cut-off factor	Hex F	O-Ring
5/16	3/8	75706E-Z66	5/8-18	4.00	2.60	1.53	2.75	5/8	ZW74706
5/16	1/2	75706E-Z68	3/4-18	4.07	2.67	1.53	2.75	3/4	ZW74708
13/32	3/8	75708E-Z66	5/8-18	4.00	2.60	1.77	2.75	5/8	ZW74706
13/32	1/2	75708E-Z68	3/4-18	4.07	2.67	2.12	2.75	3/4	ZW74708
1/2	5/8	75710E-Z70	7/8-18	4.15	2.75	2.21	2.88	7/8	ZW74710
1/2	3/4	75710E-Z72	1-1/16-16	4.25	2.85	2.35	3.00	1-1/16	ZW74712
5/8	5/8	75712E-Z70	7/8-18	4.24	2.74	2.25	2.88	7/8	ZW74710
5/8	3/4	75712E-Z72	1-1/16-16	4.35	2.85	2.87	3.00	1-1/16	ZW74712

(Includes O-ring).

Crimp fittings

757 'E' series

To determine the correct length of hose, subtract the cut-off factor for each end fitting from the overall length of assembly. All dimensions shown in inches.

H

757 'E' series

Bumped tube O-Ring Female swivel 90° tube elbow

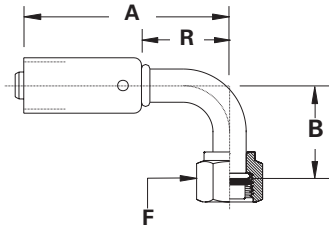

Hose I.D.	Tube size	Part number	Thread size	Length A	Run R	Drop B	Hose cut-off factor	Hex F	O-Ring
5/16	3/8	75706E-Z87	5/8-18	4.07	2.67	1.12	2.75	3/4	ZW74706
5/16	1/2	75706E-Z89	3/4-16	4.14	2.74	1.31	2.88	7/8	ZW74708
13/32	3/8	75708E-Z87	5/8-18	4.07	2.67	1.31	2.75	3/4	ZW74706
13/32	1/2	75708E-Z89	3/4-16	4.14	2.74	1.50	2.88	7/8	ZW74708
1/2	5/8	75710E-Z91	7/8-14	4.25	2.85	1.75	3.00	1-1/16	ZW74710
5/8	5/8	75712E-Z91	7/8-14	4.35	2.85	1.75	3.00	1-1/16	ZW74710
5/8	3/4	75712E-Z93	1-1/16-14	4.45	2.95	1.75	3.13	1-1/4	ZW74712

(Includes O-Ring)

Bumped tube O-Ring Female swivel 90° tube elbow w/R134a service port

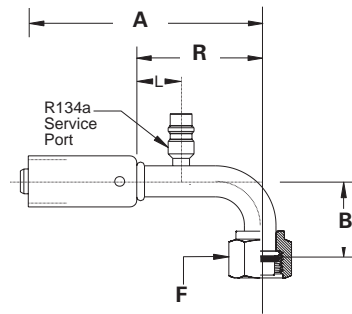

Hose I.D.	Tube Size	Part number	A	Thread Size	Run R	Drop B	Hose cut-off factor	Hex F	Length L	O-Ring
5/16	3/8	75706E-Z97*	2.52	5/8-18	2.12	1.12	2.75	3/4	1.50	ZW74706
13/32	1/2	75708E-Z99*	4.15	3/4-16	2.75	1.68	2.88	7/8	1.50	ZW74708
1/2	5/8	75710E-Z01**	3.78	7/8-14	2.38	1.50	3.00	1-1/16	1.50	ZW74710
5/8	5/8	75712E-Z01**	4.61	7/8-14	3.11	1.95	3.00	1-1/16	1.50	ZW74710

(Includes O-ring).

*High side port

**Low side port

SAE 45° Flare Female swivel 90° tube elbow

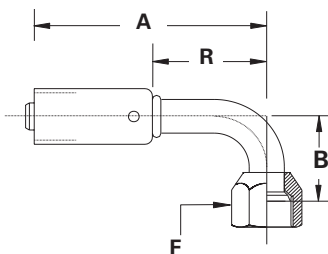

Hose I.D.	Tube Size	Part number	A	Thread Size	Run R	Drop B	Hose cut-off factor	Hex F
5/16	3/8	75706E-466	4.07	5/8-18	2.67	1.12	2.75	3/4
13/32	1/2	75708E-468	4.14	3/4-16	2.74	1.31	2.88	7/8
1/2	5/8	75710E-470	4.25	7/8-14	2.85	1.56	3.00	1-1/16
5/8	5/8	75712E-470	4.35	7/8-14	2.85	1.50	3.00	1-1/16
5/8	3/4	75712E-472	4.45	1-1/16-14	2.95	1.75	3.13	1-1/4

Bumped tube O-Ring service port adapter w/R134a service port

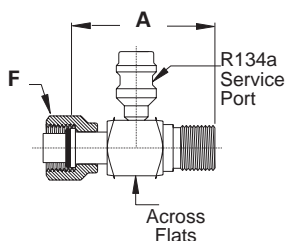

Tube A	Part number	Thread Size	Length A	Across Flats	Hex F	O-Ring
3/8	75701*	5/8-18	2.02	5/81	3/4	ZW74706
1/2	75702*	3/4-16	2.22	7/8	7/8	ZW74708
5/8	75704**	7/8-14	2.63	7/8	1-1/16	ZW74710
3/4	75706**	1-1/16-14	2.89	1-1/16	1-1/4	ZW74712

(Includes O-ring).

*High side port

**Low side port

To determine the correct length of hose, subtract the cut-off factor for each end fitting from the overall length of the assembly. All dimensions shown in inches.

757 'E' series

Bumped tube O-Ring service port adapter w/R12 service port

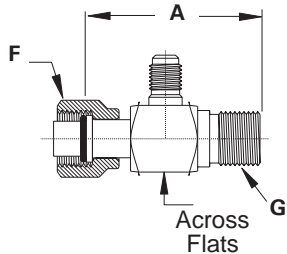

Tube Size	Part number	Thread size G	Length A	Across flats	Hex F	Service port thread	O-Ring
3/8	R12-Z56*	5/8-18	2.02	5/81	3/4	3/8-24	ZW74706
1/2	R12-Z58*	3/4-16	2.22	7/8	7/8	3/8-24	ZW74708
5/8	R12-Z60**	7/8-14	2.63	7/8	1-1/16	3/8-24	ZW74710
3/4	R12-Z62**	1-1/16-14	2.89	1-1/16	1-1/4	7/16-20	ZW74712

(Includes O-ring).
*High side port
**Low side port

90° Bumped tube O-Ring R134a service port adapter

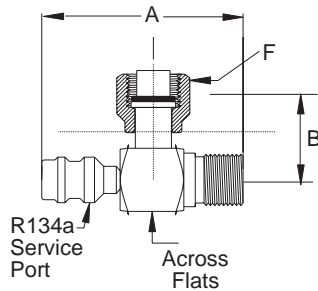

Tube Size	Part number	Thread size G	Length A	Drop B	Across flats	Hex F	O-Ring
3/8	75729*	5/8-18	2.40	1.05	5/8	3/4	ZW74706
1/2	75730*	3/4-16	2.60	1.15	7/8	7/8	ZW74708
5/8	75731**	7/8-14	2.74	1.30	7/8	1-1/16	ZW74710
3/4	75732**	1-1/16-14	3.10	1.39	1-1/16	1-1/4	ZW74712

(Includes O-ring).
*High side port
**Low side port

90° Bumped tube O-Ring R12 service port adapter

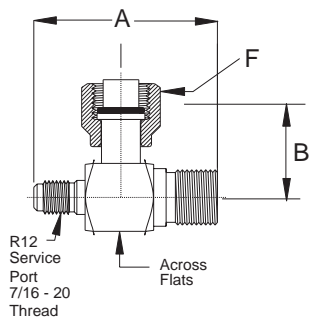

Tube Size	Part number	Thread size G	Length A	Drop B	Across flats	Hex F	O-Ring
3/8	R12-Z96*	5/8-18	2.07	1.05	5/8	3/4	ZW74706
1/2	R12-Z97*	3/4-16	2.27	1.15	7/8	7/8	ZW74708
5/8	R12-Z98**	7/8-14	2.41	1.30	7/8	1-1/16	ZW74710
3/4	R12-Z99**	1-1/16-16	2.77	1.39	1-1/16	1-1/4	ZW74712

(Includes O-ring).
*High side port
**Low side port

Replacement O-Rings



Tube O.D.	Part number
3/8	ZW74706
1/2	ZW74708
5/8	ZW74710
3/4	ZW74712

Material: Hydrogenated Nitrile (HNBR), 70 Durometer

Temperature range:
-40°F to +250°F
(-40°C to +121°C)

Color: Green

Crimp fittings

757 'E' series

To determine the correct length of hose, subtract the cut-off factor for each end fitting from the overall length of the assembly. All dimensions shown in inches.

H

757 'E' series

Tube-O to Male bumped tube O-Ring 90° elbow with R134a service

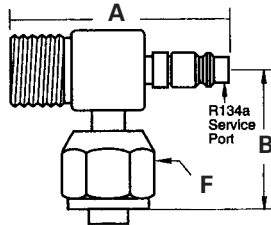

Tube Size	Part number	Length A	Drop B	Tube-O Thread F
1/2	75750*	2.64	1.15	3/4-16
5/8	75751**	2.78	1.29	7/8-14

* High-side
** Low-side

Rotalok to Male bumped tube O-Ring 90° elbow with R134a service

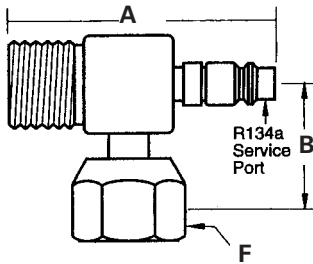

Tube Size	Part number	Length A	Drop B	Rotalok Thread F
1/2	75760*	2.64	1.15	1-14
5/8	75761**	2.78	1.29	1-14

* High-side
** Low-side

Service instructions for replacement of damaged O.E. hose assemblies

Weatherhead service port adapters offer an alternative to the high cost of replacement and time out of service which can occur when an air conditioning assembly is damaged. By using the Weatherhead adapter, service personnel can remove the damaged end and replace it with a standard Weatherhead 757 'E' series hose end used in conjunction with a Weatherhead service port adapter. This is a welcome solution to get your customer back on the road without special orders and long delays.

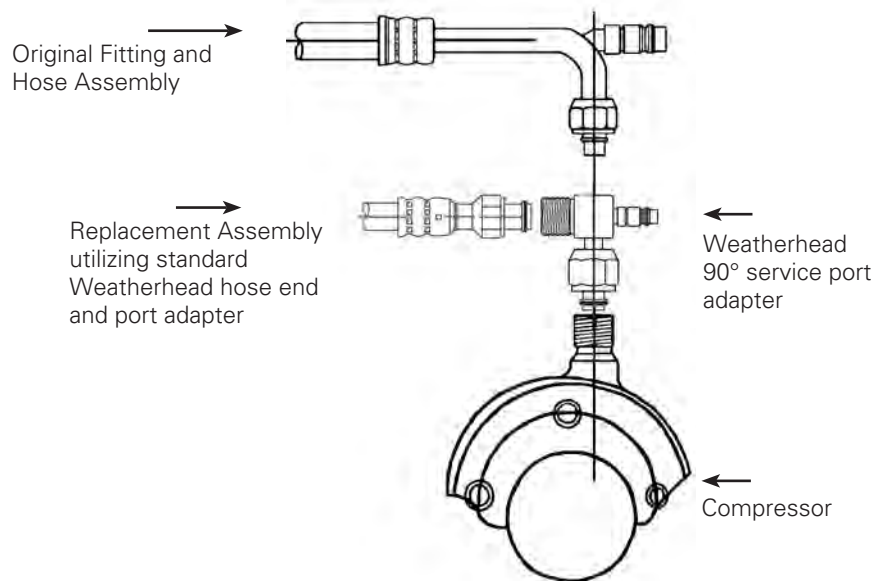

057 'P' series

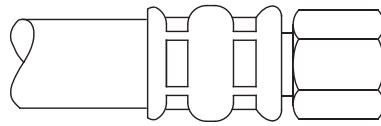

Ordering information: Order individually by part number.

 Refer to important safety information on page A-2.

Compatible hose: H429

Pressure: Determined by hose burst pressure. See pages A-24-25 for operating pressure ratings for hose end configurations.

Material: CA 360 Brass

Assemble with: T-400-1, T-410-1, T-420-1, T-440-1, T-460, T-462, T-465-1, T-480, ET4000, ET4001

Application: High pressure truck hose for use in transmission oil cooler lines, fuel lines and diesel fuel lines.

Advantages: For use with hot oil and high temperature petroleum oils.

To determine the correct length of hose, subtract the cut-off factor for each end fitting from the overall length of assembly.

SAE 45° female swivel

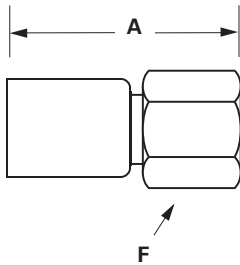

Hose I.D.	Tube size	Part number	Thread size	A	Hose cut-off factor	Hose dia.	Hex F
1/2	1/2	05708P-408	7/8-14	1.96	.99	.34	7/8
5/8	5/8	05710P-410	3/4-16	2.08	1.10	.44	1
3/4	3/4	05712P-412	1-1/16 - 14	2.05	1.12	.56	1-1/4

WARNING: California Proposition 65, see page A-2.

Crimp fittings

229 'P' series

H

229 'P' series

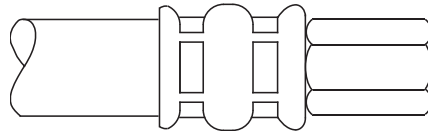

Ordering Information: Order individually by catalog number.

Refer to important safety information on page A-2.

Compatible Hose: H059, H229, H239

Pressure: Determined by maximum operating pressure for hose size. See pages A-24-25 for operating pressure ratings for hose end configurations.

Material: CA360 Brass

Assemble With: T-400-1, T-410-1, T-420-1, T-440-1, T-460, T-462, T-465-1, T-480, ET4000, ET4001

Note: Refer to current price list for availability of cataloged items. Configurations and dimensions subject to change without notice.

Application: Medium pressure air, fuel, grease, oil, truck and power steering lines.

Advantages: A permanent hose end saves time and is easy to assemble. Brass material offers excellent resistance against corrosion.

To determine the correct length of hose, subtract the cut-off factor for each end fitting from the overall length of assembly.

SAE 45° Flare female swivel

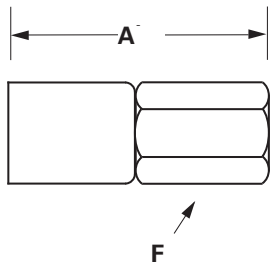

Hose I.D.	Tube size	Part number	Thread size	A	Hose cut-off factor	Hose DIA.	Hex F
3/16	1/4	22904P-404	7/16-20	1.69	.75	.13	9/16
5/16	3/8	22906P-406	5/8-18	1.80	.81	.25	3/4
13/32	1/2	22908P-408	3/4-16	1.96	1.00	.34	7/8
1/2	5/8	22910P-410	7/8-14	2.08	1.12	.44	1

Note: Collar is not attached to insert.

WARNING: California Proposition 65, see page A-2.

Componentry for 229 'P' series and 265 'P' series hose ends

1. Brass collar.
2. Brass insert.
Female SAE 45° Swivel (229 'P'), Male Pipe or Female Pipe (265 'P').

Assembly Instructions for 229 'P' series and 265 'P' series hose ends

1. Push collar onto hose until bottomed.
2. Push insert into hose until step on insert (or hex) is flush with collar.

3. Check for bottoming by checking collar movement along insert. Hose is bottomed when collar cannot slide along insert.
4. Position top of collar so that it is flush with the top of the collet. Follow recommended crimp operating procedures found in the crimp machine operator's manual.

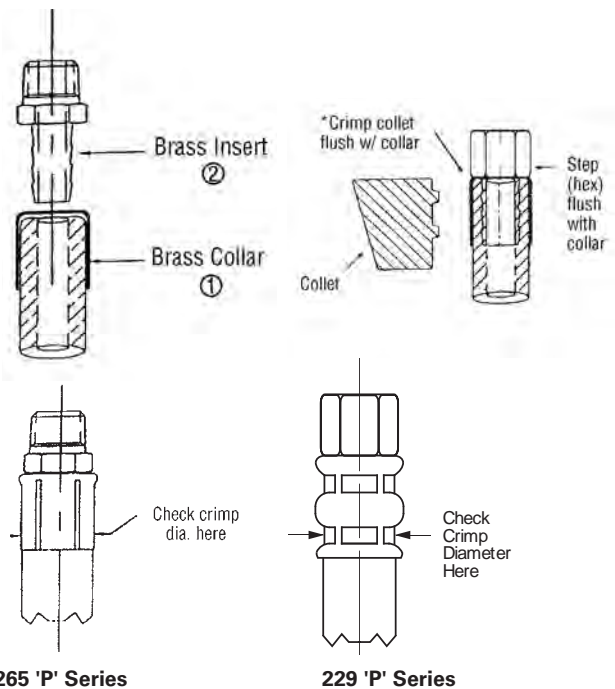

265 'P' series

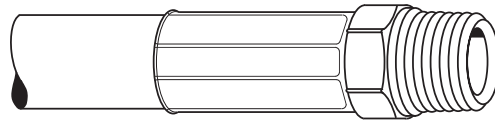

Ordering Information: Order individually by catalog number. To order replacement collar only, use base number followed by "COO" suffix. (Example: 26504P-COO)

 Refer to important safety information on page A-2.

Compatible hose:
H275, H285

Pressure: Determined by maximum operating pressure for hose size.

Material: CA360 Brass

Assemble with: T-400-1, T-410-1, T-420-1, T-440-1, T-460, T-462, T-465-1, T-480, ET4000, ET4001

Note:
For assembly instructions see page H-22.

WARNING: California Proposition 65, see page A-2.

Application: General purpose low-pressure air and water lines.

Advantages: One piece construction, easy to assemble, corrosion resistant.

To determine the correct length of hose, subtract the cut-off factor for each end fitting from the overall length of assembly.

Male pipe rigid

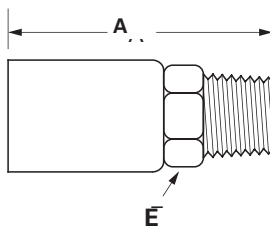

WARNING: California Proposition 65, see page A-2.

Hose I.D.	Pipe size	Part number	Thread size	A	Hose cut-off factor	Hole dia.	Hex E
1/4	1/8	26504P-102	1/8-27	1.56	.56	.18	7/16
1/4	1/4	26504P-104	1/4-18	1.63	.63	.18	9/16
1/4	3/8	26504P-106	3/8-18	1.75	.75	.18	11/16
3/8	1/8	26506P-102	1/8-27	1.56	.56	.25	7/16
3/8	1/4	26506P-104	1/4-18	1.75	.75	.31	9/16
3/8	3/8	26506P-106	3/8-18	1.74	.75	.28	11/16
3/8	1/2	26506P-108	1/2-14	1.94	1.00	.28	7/8
1/2	1/4	26508P-104	1/4-18	1.73	.75	.37	9/16
1/2	3/8	26508P-106	3/8-18	1.71	.75	.37	11/16
1/2	1/2	26508P-108	1/2-14	1.94	1.00	.37	7/8
1/2	3/4	26508P-112	3/4-18	1.94	1.00	.37	1-1/8
3/4	1/2	26512P-108	1/2-14	1.94	1.00	.37	1-1/8
3/4	3/4	26512P-112	3/4-14	1.92	1.00	.56	1-1/8

Note: Collar is not attached to insert.

Female pipe rigid

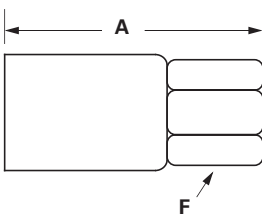

WARNING: California Proposition 65, see page A-2.

Hose I.D.	Pipe size	Part number	Thread size	A	Hose cut-off factor	Hole dia.	Hex F
1/4	1/8	26504P-202	1/8-27	1.49	.50	.18	9/16
1/4	1/4	26504P-204	1/4-18	1.60	.63	.18	11/16
3/8	1/8	26506P-202	1/8-27	1.49	.50	.28	9/16
3/8	1/4	26506P-204	1/4-18	1.60	.63	.28	11/16
3/8	3/8	26506P-206	3/8-18	1.66	.69	.28	13/16
1/2	1/4	26508P-204	1/4-18	1.57	.63	.37	11/16
1/2	3/8	26508P-206	3/8-18	1.63	.69	.37	13/16
1/2	1/2	26508P-208	1/2-14	1.85	.88	.37	1

Note: Collar is not attached to insert.

Crimp fittings

338 'P' series

H

338 'P' series

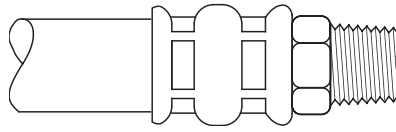

Ordering Information: Order individually by part number.

 Refer to important safety information on page A-2.

Compatible hose: EC038

Pressure: Determined by hose burst pressure. See pages A-24-25 for operating pressure ratings for hose end configurations.

WARNING: California Proposition 65, see page A-2.

Material: CA360 Brass

Assemble with: T-400-1, T-410-1, T-420-1, T-440-1, T-460, T-462, T-465, T-480, and ET4000, ET4001, ET1187, FT1380

Label set: FS-2900

Application: Air brake hose lines

Advantages: A permanent hose end saves time and is easy to assemble. Brass material offers excellent resistance against corrosion.

To determine the correct length of hose, subtract the cut-off factor for each end fitting from the overall length of assembly.

Componentry

1. Brass collar
2. Brass insert. Male pipe or brass swivel insert with brass SAE nut.
3. Brass A.B.S. insert with steel A.B.S. swivel nut.

Assembly Instructions

1. Push collar onto hose until bottomed.
2. Push insert into hose until step on insert (or hex) is flush with collar.

Note:

Swivel fittings require the use of a mandrel or an assembled adapter to push on the insert for assembly. Adapter can be removed after fitting assembly. Light lubricant may be required to assemble fitting into hose.

3. Check for bottoming by checking collar movement along insert. Hose is bottomed when collar cannot slide along insert.
4. Depending on system, follow recommended operating procedures.

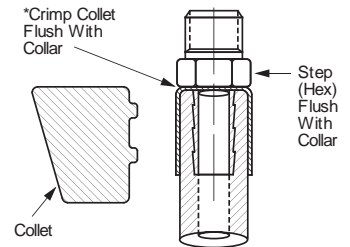
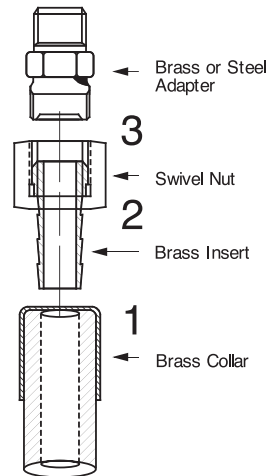

* Brass Collar is Positioned Flush With Top Collet.

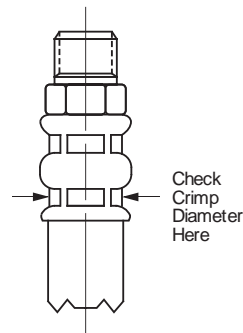

To determine the correct length of hose, subtract the cut-off factor for each end fitting from the overall length of assembly.

338 'P' series

Male pipe rigid

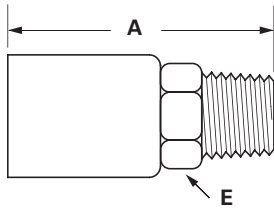

Hose I.D.	Part size	Catalog number	Thread size	A	Hose cut-off factor	Hole dia.	Hex E
3/8	1/4	33806P-104	1/4-18	1.71	.75	.28	9/16
3/8	3/8	33806P-106	3/8-18	1.72	.81	.28	11/16
3/8	1/2	33806P-108	1/2-14	1.95	1.00	.28	7/8
1/2	3/8	33808P-106	3/8-18	1.73	.81	.38	11/16
1/2	1/2	33808P-108	1/2-14	1.94	1.00	.38	7/8

WARNING: California Proposition 65, see page A-2.

Male pipe swivel

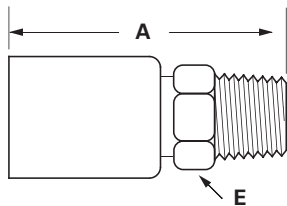

Hose I.D.	Pipe size	Part number	Thread size	A	Hose cut-off factor	Hole dia.	Hex E
3/8	3/8	33806P-J06	3/8-18	1.66	.81	.28	11/16

Note: Swivel for installation purposes only.

WARNING: California Proposition 65, see page A-2.

SAE 45° female swivel

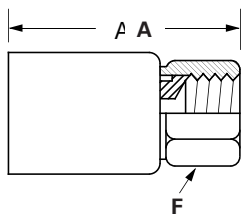

Hose I.D.	Tube size	Part number	Thread size	A	Hose cut-off factor	Hole dia.	Hex F
3/8	3/8	33806P-406	5/8-18	1.31	1.00	.28	3/4
1/2	1/2	33808P-408	3/4-16	1.36	1.00	.38	7/8

WARNING: California Proposition 65, see page A-2.

Air brake slider line

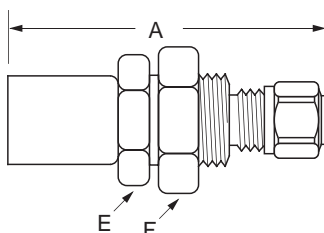

Hose I.D.	Tube size	Part number	Thread size	A	Hose cut-off factor	Hole dia.	Hex E	Hex F
3/8	3/8	33806P-Y66	17/32-24	2.41	1.00	.28	1-1/16	1-1/8
3/8	1/2	33806P-Y68	11/16-20	2.51	1.00	.28	1-1/16	1-1/8
1/2	1/2	33808P-Y68	11/16-20	2.69	1.28	.41	7/8	13/16

WARNING: California Proposition 65, see page A-2.

Crimp fittings

338 'P' series

To determine the correct length of hose, subtract the cut-off factor for each end fitting from the overall length of assembly.

H

338 'P' series

Air brake swivel

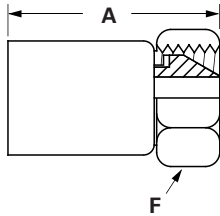

Hose I.D.	ABS size	Part number	Thread size	A	Hose cut-off factor	Hole dia.	Hex F
3/8	3/8	33806P-Y76	3/4-20	1.38	1.00	.28	7/8
1/2	3/8	33808P-Y76	3/4-20	1.38	1.00	.28	7/8
1/2	1/2	33808P-Y78	7/8-20	1.44	1.00	.38	1

WARNING: California Proposition 65, see page A-2.

Adapter

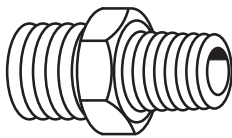

ABS Thread Size	Pipe size	Part number	Overall length	ABS Thread size
3/8	1/4	1390x6	1.18	3/4-20
3/8	3/8	1390x6x6	1.18	3/4-20
3/8	1/2	1390x6x8	1.37	3/4-20
1/2	3/8	1390x8	1.18	7/8-20
1/2	1/2	1390x8x8	1.37	7/8-20

WARNING: California Proposition 65, see page A-2.

'Z' series

The next generation technology of Eaton's 'Z' Series hose ends are compatible with the most Weatherhead standard and newer generation hose styles combining best-in-class technologies to meet and exceed the highest globally recognized standards for 1 and 2 wire braid hydraulic hose assemblies.

The total array of over 550 'Z' Series hose ends meets virtually all customer needs for domestic and non-North American thread styles and configurations. The resulting hose assemblies provide superior performance in the demanding applications often encountered within mobile and industrial equipment.

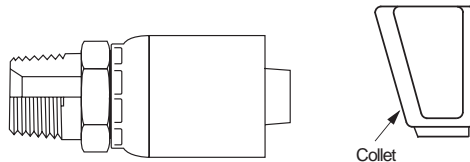

Ordering information:
Order individually by catalog number. O-rings not supplied with flange hose ends. Order O-rings by catalog number; reference individual listings for details. For split flange kits refer to pages J-110-112 and for O-rings refer to pages J-112-113.

Note: Refer to current price list for availability of cataloged items. Configurations and dimensions subject to change without notice.

Pressure: Determined by maximum working pressure for hose size and hose end configuration whichever is less. For working pressure ratings for hose end configurations, refer to pages A-24-25.

Material: low carbon steel

Plating: trivalent zinc plated

Assemble with:
T-400-1, T-410-1, T-420-1, T-440, T-460, T-462, T-465, T-480, ET1000, ET1187, ET4000, ET4001, FT1380, FT1390, ET4020 and ET4040.

Label set: FF90645

Application: General purpose low, medium, and high pressure hydraulic.

Advantages:
Wide selection of hose and end configurations allowing a diverse number of applications.

To determine the correct length of hose, subtract the cut-off factor for each end fitting from the overall length of assembly.

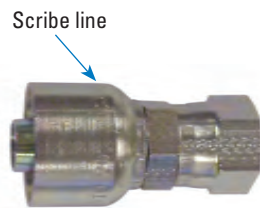

Easy assembly

Z Series hose ends are assembled with Weatherhead hose using existing positive stop and variable crimp machines.

The hose ends have a scribe line around the circumference of the socket to easily identify the location where the collets and variable crimp dies are positioned for crimping.

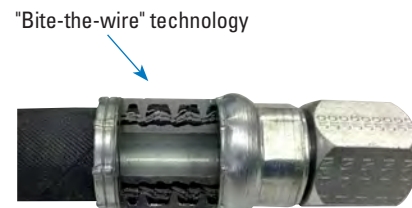

Higher operating and burst pressure

Z Series hose ends feature advanced "Bite-the-wire" technology:

- Advanced "Bite-the-wire" design provides higher operating and burst pressure
- Eliminates cool down leakage
- Flat crimp for easier routing
- Compatible with multiple hose styles to accommodate most application needs

Crimp fittings

'Z' series

	Part number example	Page number
Male Pipe Rigid	08Z-108	H-31
Male Pipe Swivel	08Z-J08	H-31
Female Pipe Rigid	08Z-208	H-32
Female Pipe Swivel	08Z-258	H-32
Female Straight Pipe Swivel (NPSM)	08Z-058	H-32
Male Pipe Swivel 90° Elbow	08Z-M08	H-33
JIC/37° Female Swivel	08Z-608	H-33
JIC/37° Female Swivel 30° Tube Elbow	10Z-L22	H-34
JIC/37° Female Swivel 45° Tube Elbow	08Z-688	H-34
JIC/37° Female Swivel 90° Tube Elbow	08Z-668	H-35
JIC/37° Female Swivel 90° Long Drop Tube Elbow	08Z-648	H-35
JIC/37° Male Rigid	08Z-508	H-36
SAE 45° Female Swivel	08Z-408	H-36
SAE 45° Female Swivel 45° Tube Elbow	06Z-486	H-36
SAE 45° Female Swivel Long Drop 90° Tube Elbow	06Z-446	H-37
SAE 45° Flare Male Rigid	06Z-306	H-37
Female ORS Swivel	08Z-S68	H-37
Female ORS Swivel 45° Tube Elbow	08Z-L68	H-38
Female ORS Swivel Short Drop 90° Tube Elbow	08Z-A28	H-38
Female ORS Swivel Medium Drop 90° Tube Elbow	08Z-J38	H-39
Female ORS Swivel Long Drop 90° Tube Elbow	08Z-A68	H-39
ORS Male Rigid	08Z-E68	H-40
Male Straight Thread O-ring Rigid	08Z-P08	H-40
Male Straight Thread O-ring Swivel	08Z-R08	H-41
Male Straight Thread O-ring Swivel 90° Elbow	08Z-R68	H-41
Flareless Tube Rigid Ermeto 7000 Series	08Z-758	H-41
Flareless 45° Tube Elbow 7000 Ermeto Series	06Z-956	H-42
Flareless 90° Tube Elbow 7000 Ermeto Series	06Z-976	H-42
Inverted Male Swivel Straight	08Z-B08	H-42
Inverted Male Swivel 45° Tube Elbow	08Z-B48	H-43
Inverted Male Swivel 90° Tube Elbow	08Z-B68	H-43
Split Flange Straight (SAE Code 61)	12Z-G12	H-43
Split Flange 22.5° Tube Elbow (SAE Code 61)	16Z-H03	H-44
Split Flange 45° Tube Elbow (SAE Code 61)	12Z-G42	H-44
Split Flange 60° Tube Elbow (SAE Code 61)	16Z-H53	H-45
Split Flange 67° tube elbow (SAE Code 61)	20Z-H60	H-45
Split Flange 90° Tube Elbow (SAE Code 61)	12Z-G72	H-45
Metric Split Flange Straight (Komatsu, Linkbelt, etc.)	10Z-G09	H-46
Metric Split Flange 45° Tube Elbow (Komatsu, Linkbelt, etc.)	10Z-G69	H-46
Metric Split Flange 90° Tube Elbow (Komatsu, Linkbelt, etc.)	10Z-G99	H-46
READY-LOK® Male Connector	08Z-08S	H-47
Standpipe Straight Tube	08Z-T08	H-47
Metric Standpipe Straight Tube	08Z-45T	H-47
Pressure Washer Connection	06Z-6PW	H-48
BSPP Flat Face Female Swivel	08Z-08PA	H-48
British Standard (BSPP) 60° Cone Female Swivel Straight	08Z-358	H-48
British Standard (BSPP) 60° Cone Female 45° Tube Elbow	08Z-48P	H-49
British Standard (BSPP) 60° Cone Female 90° Tube Elbow	08Z-78P	H-49
British Standard (BSPT) Tapered Male Rigid	08Z-158	H-49
British Standard (BSPP) 60° Cone Male Rigid	08Z-P58	H-50
Female JIS 30° Flare Swivel Straight	08Z-08L	H-50
Female Swivel 30° Flare (Komatsu, Linkbelt)	08Z-22K	H-50
Female Swivel DIN 24° Seat I.Rh DKO (Light)	08Z-15C	H-51
Female Swivel DIN Universal Seat 45° Tube Elbow (Light)	08Z-15D	H-51
Female Swivel DIN Universal Seat 90° Tube Elbow (Light)	08Z-65D	H-51
Male DIN 24° Seat I.Rh (Light)	08Z-15A	H-52
Female Swivel DIN 24° Seat s.Rh DKO (Heavy)	08Z-64C	H-52
Female Swivel DIN 24° Seat 45° Tube Elbow s.Rh (Heavy)	08Z-16E	H-52
Female Swivel DIN 24° Seat 90° Tube Elbow s.Rh DKO (Heavy)	08Z-66E	H-53
Male DIN 24° Seat s.Rh (Heavy)	08Z-16F	H-53
STC Male Straight	08Z-BC08	H-54
STC Male 45° Tube Elbow	08Z-BC48	H-54
STC Male 90° Tube Elbow	08Z-BC68	H-54
STC Male 90° Long Drop Tube Elbow	08Z-BC88	H-54

'Z' series

Male pipe rigid

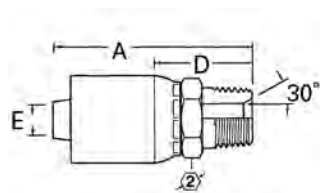

* Stainless Steel

Z Series Part number	Thd.	Hose size	A		Hose cut-off factor (D)		EØ		② in
			mm	in	mm	in	mm	in	
04Z-102	1/8-27	-04	46,7	1.84	23,4	0.92	4,3	0.17	9/16
04Z-104	1/4-18	-04	52,3	2.06	29,0	1.14	4,3	0.17	9/16
04ZR-104*	1/4-18	-04	52,3	2.06	29,0	1.14	4,3	0.17	9/16
04Z-106	3/8-18	-04	48,3	1.90	24,9	0.98	4,3	0.17	11/16
04Z-108	1/2-14	-04	51,3	2.02	31,2	1.23	4,3	0.17	7/8
06Z-104	1/4-18	-06	55,4	2.18	30,0	1.18	6,6	0.26	11/16
06Z-106	3/8-18	-06	57,7	2.27	32,5	1.28	6,6	0.26	11/16
06ZR-106*	3/8-18	-06	57,7	2.27	32,5	1.28	6,6	0.26	11/16
06Z-108	1/2-14	-06	57,7	2.27	32,5	1.28	4,1	0.16	7/8
08Z-104	1/4-18	-08	61,0	2.40	31,2	1.23	7,6	0.30	13/16
08Z-106	3/8-18	-08	63,2	2.49	33,5	1.32	9,7	0.38	13/16
08Z-108	1/2-14	-08	69,6	2.74	39,6	1.56	9,7	0.38	7/8
08ZR-108*	1/2-14	-08	69,6	2.74	39,6	1.56	9,7	0.38	7/8
08Z-112	3/4-14	-08	65,0	2.56	35,3	1.39	9,7	0.38	11/16
10Z-106	3/8-18	-10	59,9	2.36	33,8	1.33	10,7	0.42	15/16
10Z-108	1/2-14	-10	69,6	2.74	40,1	1.58	12,7	0.50	15/16
10Z-112	3/4-14	-10	65,0	2.56	35,6	1.40	12,7	0.50	11/16
12Z-108	1/2-14	-12	70,6	2.78	40,6	1.60	14,2	0.56	11/8
12Z-112	3/4-14	-12	72,1	2.84	41,9	1.65	15,5	0.61	11/8
12ZR-112*	3/4-14	-12	72,1	2.84	41,9	1.65	15,5	0.61	11/8
12Z-116	1-11/2	-12	71,1	2.80	40,9	1.61	15,5	0.61	13/8
16Z-112	3/4-14	-16	76,7	3.02	42,4	1.67	19,3	0.76	13/8
16Z-116	1-11/2	-16	81,8	3.22	47,2	1.86	20,8	0.82	13/8
16ZR-116*	1-11/2	-16	81,8	3.22	47,2	1.86	20,8	0.82	13/8
16Z-120	11/4-111/2	-16	78,2	3.08	43,7	1.72	20,8	0.82	111/16
20Z-116	1-11/2	-20	93,0	3.66	49,0	1.93	24,1	0.95	13/4
20Z-120	11/4-111/2	-20	89,4	3.52	45,5	1.79	26,7	1.05	113/16
24Z-124	11/2-111/2	-24	106,2	4.18	59,9	2.36	32,0	1.26	2
32Z-132	2-111/2	-32	116,6	4.59	66,3	2.61	44,5	1.75	21/2

Male pipe swivel

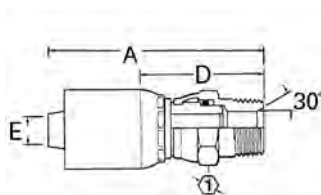

Z Series Part number	Thd.	Hose size	A		Hose cut-off factor (D)		EØ		① in
			mm	in	mm	in	mm	in	
04Z-J04	1/4-18	-04	64,5	2.54	41,4	1.62	4,3	0.17	3/4
06Z-J04	1/4-18	-06	63,5	2.54	42,4	1.67	6,6	0.26	3/4
06Z-J06	3/8-18	-06	67,6	2.66	42,4	1.67	6,6	0.26	7/8
06Z-J08	1/2-14	-06	72,4	2.85	47,0	1.85	6,6	0.26	7/8
08Z-J06	3/8-18	-08	73,2	2.88	43,4	1.71	9,7	0.38	7/8
08Z-J08	1/2-14	-08	79,5	3.13	49,8	1.96	9,7	0.38	15/16
12Z-J12	3/4-14	-12	82,3	3.24	52,1	2.05	15,5	0.61	13/8
16Z-J16	1-11/2	-16	98,6	3.88	64,3	2.53	20,6	0.81	11/2

Crimp fittings

'Z' series

H

'Z' series

Female pipe rigid

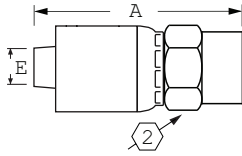

Z Series Part number	Thd.	Hose size	A		Hose cut-off factor		EØ		2
			mm	in	mm	in	mm	in	
04Z-202	1/8-27	-04	52,6	2.07	32,5	1.28	4,3	0.17	9/16
04Z-204	1/4-18	-04	58,4	2.30	38,4	1.51	4,3	0.17	3/4
06Z-204	1/4-18	-06	58,4	2.30	37,1	1.46	6,6	0.26	3/4
06Z-206	3/8-18	-06	61,2	2.41	39,9	1.57	6,6	0.26	7/8
08Z-208	1/2-14	-08	66,5	2.62	42,0	1.65	9,7	0.38	1 1/16
12Z-212	3/4-14	-12	90,9	3.58	64,0	2.52	15,5	0.61	1 5/16

* G as part of thread size is ISO Designation for parallel thread.

Female pipe swivel

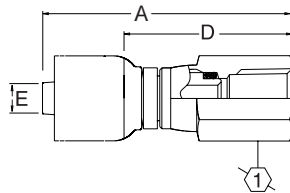

Z Series Part number	Thd.	Hose size	A		Hose cut-off factor (D)		EØ		1
			mm	in	mm	in	mm	in	
04Z-254	1/4-18	-04	72,9	2.87	49,5	1.95	4,3	0.17	3/4
06Z-256	3/8-18	-06	75,4	2.97	50,0	1.97	6,6	0.26	7/8
08Z-258	1/2-14	-08	90,9	3.58	61,2	2.41	9,7	0.38	1 1/16
12Z-262	3/4-14	-12	92,2	3.63	62,0	2.44	15,5	0.61	1 3/8
16Z-266	1-1 1/2	-16	111,0	4.37	77,5	3.05	20,6	0.81	1 5/8

Female straight pipe swivel (NPSM)

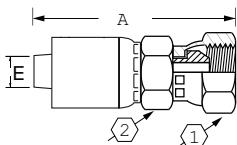

Z Series Part number	Thd.	Hose size	A		Hose cut-off factor (D)		EØ		2	1
			mm	in	mm	in	mm	in		
04Z-054	1/4-18	-04	47,8	1.88	27,7	1.09	4,3	0.17	9/16	11/16
06Z-056	3/8-18	-06	51,8	2.04	30,5	1.20	6,6	0.26	11/16	7/8
08Z-058	1/2-14	-08	61,0	2.40	35,8	1.41	9,7	0.38	7/8	1
12Z-062	3/4-14	-12	66,5	2.62	39,6	1.56	15,5	0.61	1 1/8	1 1/4
16Z-066	1-1 1/2	-16	79,0	3.11	29,9	1.18	20,8	0.81	1 3/8	1 1/2
20Z-070	1 1/4-1 1/2	-20	92,7	3.65	53,3	2.10	26,7	1.05	1 3/4	1 7/8

'Z' series

Male pipe swivel 90° elbow

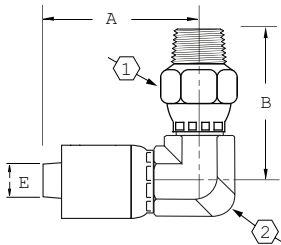

Z Series Part number	Thd.	Hose size	A		Hose cut-off factor (D)		EØ		⊘2	⊘1	B
			mm	in	mm	in	mm	in			
04Z-M04	1/4-18	-04	54,6	2.15	31,2	1.23	4,3	0.17	3/4	3/4	1.81
06Z-M04	1/4-18	-06	54,9	2.16	33,7	1.33	6,6	0.26	3/4	7/8	1.96
06Z-M06	3/8-18	-06	59,2	2.33	33,7	1.33	6,6	0.26	3/4	7/8	1.80
08Z-M08	1/2-14	-08	68,1	2.68	38,3	1.51	9,6	0.38	3/4	15/16	2.05
12Z-M12	3/4-14	-12	94,5	3.72	64,2	2.53	15,4	0.61	1 1/4	1 3/8	2.72

JIC/37° female swivel

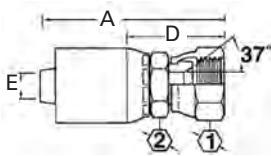

* Stainless steel

Z Series Part number	Thd.	Hose size	A		Hose cut-off factor (D)		EØ		⊘1	⊘2
			mm	in	mm	in	mm	in		
04Z-603	3/8-24	-04	49,3	1.94	25,9	1.02	3,3	0.13	1/2	9/16
04Z-604	7/16-20	-04	50,8	2.00	27,2	1.07	4,3	0.17	9/16	9/16
04ZR-604*	7/16-20	-04	50,8	2.00	27,2	1.07	4,3	0.17	9/16	9/16
04Z-605	1/2-20	-04	50,3	1.98	26,9	1.06	4,3	0.17	5/8	9/16
04Z-606	9/16-18	-04	51,6	2.03	28,2	1.11	4,3	0.17	11/16	9/16
06Z-604	7/16-20	-06	55,6	2.19	30,2	1.19	4,3	0.17	9/16	11/16
06Z-605	1/2-20	-06	56,9	2.24	31,5	1.24	5,8	0.23	5/8	11/16
06Z-606	9/16-18	-06	57,9	2.28	32,5	1.28	6,6	0.26	11/16	11/16
06ZR-606*	9/16-18	-06	57,9	2.28	32,5	1.28	6,6	0.26	11/16	11/16
06Z-608	3/4-16	-06	58,7	2.31	33,3	1.31	6,6	0.26	7/8	11/16
06Z-610	7/8-14	-06	57,4	2.26	13,2	0.52	6,6	0.26	1	13/16
06Z-612	1 1/16-12	-06	59,5	2.34	38,4	1.51	6,7	0.26	1 1/4	1
08Z-606	9/16-18	-08	59,9	2.36	34,5	1.36	9,6	0.33	11/16	13/16
08Z-608	3/4-16	-08	66,8	2.63	37,1	1.46	9,7	0.38	7/8	13/16
08ZR-608*	3/4-16	-08	66,8	2.63	37,1	1.46	9,7	0.38	7/8	13/16
08Z-610	7/8-14	-08	67,1	2.64	37,3	1.47	9,7	0.38	1	13/16
08Z-612	1 1/16-12	-08	69,3	2.73	39,6	1.56	9,7	0.38	1 1/4	1
08Z-616	1 5/16-12	-08	77,7	3.06	48,0	1.89	9,7	0.38	1 1/2	1 1/4
10Z-608	3/4-16	-10	67,3	2.65	38,1	1.50	9,9	0.39	7/8	15/16
10Z-610	7/8-14	-10	70,4	2.77	40,9	1.61	12,7	0.50	1	15/16
10ZR-610*	7/8-14	-10	70,4	2.77	40,9	1.61	12,7	0.50	1	15/16
10Z-612	1 1/16-12	-10	69,1	2.72	39,9	1.57	12,7	0.50	1 1/4	1
12Z-608	3/4-16	-12	66,0	2.60	38,8	1.53	9,9	0.39	7/8	1 1/8
12Z-610	7/8-14	-12	71,4	2.81	41,4	1.63	12,2	0.48	1	1 1/8
12Z-612	1 1/16-12	-12	72,1	2.84	41,9	1.65	15,5	0.61	1 1/4	1 1/8
12ZR-612*	1 1/16-12	-12	72,1	2.84	41,9	1.65	15,5	0.61	1 1/4	1 1/8
12Z-614	1 3/16-12	-12	72,1	2.84	41,9	1.65	15,5	0.61	1 3/8	1 1/8
12Z-616	1 5/16-12	-12	73,9	2.91	43,7	1.72	15,5	0.61	1 1/2	1 1/4
16Z-612	1 1/16-12	-16	80,0	3.15	45,7	1.80	15,5	0.61	1 1/4	1 3/8
16Z-614	1 3/16-12	-16	80,0	3.15	46,5	1.83	20,6	0.81	1 3/8	1 3/8
16Z-616	1 5/16-12	-16	83,6	3.29	49,0	1.93	20,6	0.81	1 1/2	1 3/8
16ZR-616*	1 5/16-12	-16	83,6	3.29	49,0	1.93	20,6	0.81	1 1/2	1 3/8
16Z-620	1 5/8-12	-16	80,5	3.17	46,0	1.81	20,6	0.81	2	
20Z-616	1 5/16-12	-20	87,9	3.46	43,9	1.73	21,6	0.85	1 1/2	
20Z-620	1 5/8-12	-20	91,7	3.61	47,8	1.88	26,7	1.05	2	
24Z-624	1 7/8-12	-24	99,1	3.90	52,6	2.07	32,0	1.26	2 1/4	
32Z-632	2 1/2-12	-32	110,2	4.34	60,7	2.39	44,5	1.75	2 7/8	

Crimp fittings

'Z' series

H

'Z' series

JIC/37° female swivel 30° tube elbow

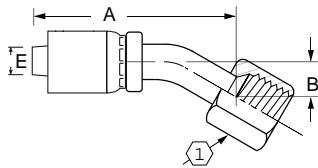

Z Series Part number	Thd.	Hose size	A		Hose cut-off factor (D)		EØ		1	B
			mm	in	mm	in	mm	in		
10Z-L22	1 ¹ / ₁₆ -12	-10	86,1	3.39	60,5	2.38	12,7	0.51	1/4 Hex	0.69

JIC/37° female swivel 45° tube elbow

(Exceptions noted)

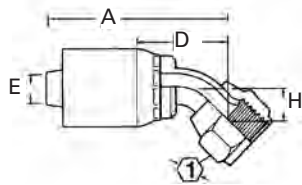

Z Series Part number	Thd.	Hose size	A		Hose cut-off factor (D)		EØ		H		1
			mm	in	mm	in	mm	in	mm	in	
04Z-684 ^a	7/16-20	-04	49,8	1.96	26,4	1.04	3,8	0.15	8,4	0.33	9/16
04Z-685 ^a	1/2-20	-04	51,8	2.04	28,4	1.12	4,3	0.17	9,4	0.37	5/8
04Z-686	9/16-18	-04	53,1	2.09	29,7	1.17	4,3	0.17	9,9	0.39	11/16
06Z-684 ^a	7/16-20	-06	44,5	1.75	23,4	0.92	4,1	0.16	8,4	0.33	9/16
06Z-686	9/16-18	-06	58,7	2.31	33,3	1.31	6,1	0.24	9,9	0.39	11/16
06Z-688 ^a	3/4-16	-06	67,3	2.65	42,2	1.66	6,6	0.26	14,0	0.55	7/8
08Z-688 ^a	3/4-16	-08	71,6	2.82	41,9	1.65	9,4	0.37	14,0	0.55	7/8
08Z-690 ^a	7/8-14	-08	77,0	3.03	47,2	1.86	9,7	0.38	15,0	0.59	1
10Z-690 ^a	7/8-14	-10	74,7	2.94	45,5	1.79	11,7	0.46	15,0	0.59	1
10Z-692	1 ¹ / ₁₆ -12	-10	85,9	3.38	56,4	2.22	12,7	0.50	19,8	0.78	1 ¹ / ₄
12Z-696	1 ⁵ / ₁₆ -12	-12	87,1	3.43	60,2	2.37	15,5	0.61	26,9	1.06	1 ¹ / ₂
12Z-692	1 ¹ / ₁₆ -12	-12	87,1	3.43	56,9	2.24	14,7	0.58	19,8	0.78	1 ¹ / ₄
16Z-696	1 ⁵ / ₁₆ -12	-16	95,0	3.74	60,7	2.39	19,3	0.76	27,2	1.07	1 ¹ / ₂
20Z-697	1 ⁵ / ₈ -12	-20	112,8	4.44	68,8	2.71	25,7	1.01	31,0	1.22	2

^a Swivel nuts are universal – both SAE 37° and 45° connections.

'Z' series

JIC/37° female swivel
90° elbow

(Exceptions noted)

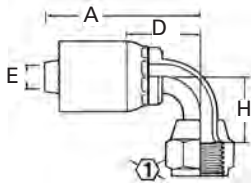

Z Series Part number	Thd.	Hose size	A		Hose cut-off factor (D)		EØ		H		in
			mm	in	mm	in	mm	in	mm	in	
04Z-664 ^a	7/16-20	-04	46,7	1.84	23,4	0.92	3,8	0.15	17,3	0.68	9/16
04Z-665 ^a	1/2-20	-04	48,8	1.92	25,4	1.00	4,3	0.17	19,3	0.76	5/8
04Z-666	9/16-18	-04	50,8	2.00	27,4	1.08	4,3	0.17	21,3	0.84	11/16
06Z-664 ^a	7/16-20	-06	46,0	1.81	24,9	0.98	4,1	0.16	17,3	0.68	9/16
06Z-666	9/16-18	-06	56,1	2.21	31,0	1.22	6,1	0.24	21,3	0.84	11/16
06Z-668 ^a	3/4-16	-06	61,5	2.42	36,1	1.42	6,6	0.26	27,7	1.09	7/8
08Z-666	9/16-18	-08	61,7	2.43	32,0	1.26	6,1	0.24	21,3	0.84	11/16
08Z-668 ^a	3/4-16	-08	65,8	2.59	36,1	1.42	9,4	0.37	27,7	1.09	7/8
08Z-670 ^a	7/8-14	-08	70,6	2.78	41,0	1.61	9,7	0.38	30,2	1.19	1
10Z-670 ^a	7/8-14	-10	68,6	2.70	39,4	1.55	11,4	0.45	30,2	1.19	1
10Z-672	1 1/16-12	-10	84,1	3.31	54,9	2.16	12,7	0.50	45,7	1.80	1 1/4
12Z-670 ^a	7/8-14	-12	65,3	2.57	39,6	1.56	11,7	0.46	30,2	1.19	1
12Z-672	1 1/16-12	-12	85,4	3.36	55,1	2.17	17,4	0.58	45,7	1.80	1 1/4
12Z-676	1 5/16-12	-12	85,6	3.37	55,4	2.18	15,5	0.61	60,7	2.39	1 1/2
16Z-676	1 5/16-12	-16	90,4	3.56	55,9	2.20	19,3	0.76	60,7	2.39	1 1/2
16Z-677	1 5/8-12	-16	95,8	3.77	62,2	2.45	20,8	0.82	69,9	2.75	2
20Z-677	1 5/8-12	-20	108,0	4.25	64,0	2.52	25,7	1.01	69,9	2.75	2
24Z-678	1 7/8-12	-24	117,6	4.63	71,4	2.81	32,0	1.26	80,5	3.17	2 1/4

^a Swivel nuts are universal – both SAE 37° and 45° connections.

JIC/37° female swivel
90° long drop tube elbow

(Exceptions noted)

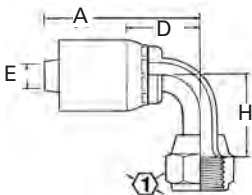

Z Series Part number	Thd.	Hose size	A		Hose cut-off factor (D)		EØ		H		in
			mm	in	mm	in	mm	in	mm	in	
04Z-644 ^a	7/16-20	-04	46,7	1.84	23,4	0.92	3,8	0.15	45,7	1.80	9/16
04Z-645 ^a	1/2-20	-04	48,8	1.92	25,4	1.00	4,3	0.17	45,7	1.80	5/8
06Z-644 ^a	7/16-20	-06	46,0	1.81	24,9	0.98	4,3	0.17	45,7	1.80	9/16
06Z-646	9/16-18	-06	56,4	2.22	31,2	1.23	6,1	0.24	55,4	2.18	11/16
06Z-648 ^a	3/4-16	-06	64,5	2.54	39,1	1.54	6,6	0.26	62,2	2.45	7/8
08Z-648 ^a	3/4-16	-08	68,8	2.71	39,1	1.54	9,4	0.37	62,2	2.45	7/8
08Z-650 ^a	7/8-14	-08	70,6	2.78	40,9	1.61	9,7	0.38	65,3	2.57	1
10Z-650 ^a	7/8-14	-10	68,6	2.70	39,1	1.54	11,7	0.46	65,3	2.57	1
12Z-652 *	1 1/16-12	-12	85,3	3.36	55,1	2.17	14,7	0.58	94,0	3.70	1 1/4
16Z-656 **	1 5/16-12	-16	90,4	3.56	55,9	2.20	19,3	0.76	116,3	4.58	1 1/2
20Z-657	1 5/8-12	-20	108,0	4.25	64,0	2.52	25,7	1.01	140,5	5.53	2

^a Swivel nuts are universal – both SAE 37° and 45° connections.

* The 90° long drop tube elbow configuration meets a 3.5:1 burst, based on 4000psi operating pressure.

**The 90° long drop tube elbow configuration meets a 3.7:1 burst, based on 3000psi operating pressure.

Crimp fittings

'Z' series

H

'Z' series

JIC/37° male rigid

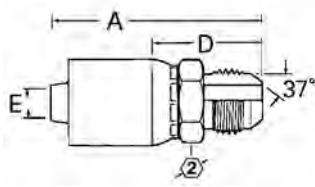

Z Series Part number	Thd.	Hose size	A		Hose cut-off factor (D)		EØ		②
			mm	in	mm	in	mm	in	
04Z-504	7/16-20	-04	50,8	2.00	27,2	1.07	4,3	0.17	9/16
04Z-505	1/2-20	-04	46,7	1.84	23,4	0.92	4,3	0.17	9/16
04Z-506	9/16-18	-04	47,0	1.85	23,6	0.93	4,3	0.17	5/8
06Z-506	9/16-18	-06	54,9	2.16	29,7	1.17	6,6	0.26	11/16
06Z-508	3/4-16	-06	53,3	2.10	28,2	1.11	6,6	0.26	13/16
06Z-510	7/8-14	-06	53,3	2.10	30,7	1.21	6,6	0.26	15/16
08Z-508	3/4-16	-08	65,3	2.57	35,8	1.41	9,7	0.38	13/16
08Z-510	7/8-14	-08	61,5	2.42	32,0	1.26	9,7	0.38	15/16
08Z-512	1 1/16-12	-08	65,8	2.59	36,1	1.42	9,7	0.38	1 1/8
10Z-508	3/4-16	-10	61,7	2.43	35,8	1.41	12,7	0.50	15/16
10Z-510	7/8-14	-10	69,3	2.73	39,9	1.57	12,2	0.48	15/16
10Z-512	1 1/16-12	-10	65,8	2.59	36,3	1.43	12,7	0.50	1 1/8
12Z-510	7/8-14	-12	70,6	2.78	40,4	1.59	12,2	0.48	1 1/8
12Z-512	1 1/16-12	-12	74,7	2.94	44,5	1.75	15,5	0.61	1 1/8
12Z-514	1 3/16-12	-12	69,3	2.73	39,1	1.54	15,5	0.61	1 1/4
12Z-516	1 5/16-12	-12	69,9	2.75	39,6	1.56	15,5	0.61	1 3/8
16Z-514	1 3/16-12	-16	79,0	3.11	45,7	1.80	18,3	0.72	1 3/8
16Z-516	1 5/16-12	-16	82,6	3.25	48,3	1.90	20,8	0.82	1 3/8
16Z-520	1 5/8-12	-16	77,0	3.03	43,4	1.71	20,6	0.81	1 11/16
20Z-520	1 5/8-12	-20	98,8	3.89	54,9	2.16	26,7	1.05	1 3/4
24Z-524	1 7/8-12	-24	109,5	4.31	63,2	2.49	32,0	1.26	2

SAE 45° female swivel

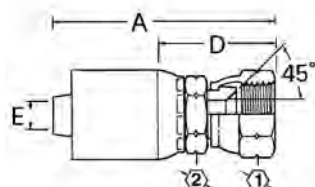

Z Series Part number	Thd.	Hose Size	A		Hose cut-off factor (D)		EØ		①	②
			mm	in	mm	in	mm	in		
04Z-404	7/16-20	-04	50,8	2.00	27,2	1.07	4,3	0.17	9/16	9/16
06Z-404	7/16-20	-06	55,6	2.19	30,2	1.19	4,8	0.19	9/16	11/16
06Z-406	5/8-18	-06	58,7	2.31	33,3	1.31	6,6	0.26	3/4	11/16
06Z-408	3/4-16	-06	58,7	2.31	33,3	1.31	6,6	0.26	7/8	11/16
08Z-408	3/4-16	-08	66,8	2.63	37,1	1.46	9,7	0.38	7/8	13/16
08Z-410	7/8-14	-08	67,1	2.64	37,3	1.47	9,7	0.38	1	13/16
12Z-412	1 1/16-14	-12	72,1	2.84	41,9	1.65	15,5	0.61	1 1/4	1 1/8

SAE 45° female swivel 45° tube elbow

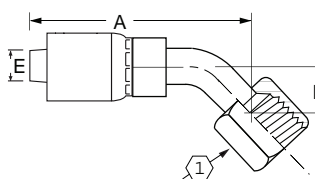

Z Series Part number	Thd.	Hose Size	A		Hose cut-off factor (D)		EØ		①	B
			mm	in	mm	in	mm	in		
06Z-486	5/8-18	-06	58,2	2.29	36,8	1.45	6,1	0.24	3/4	0.73

'Z' series

SAE 45° female swivel long drop 90° tube elbow

Z Series Part number	Thd.	Hose size	A		Hose cut-off factor (D)		EØ		1	B
			mm	in	mm	in	mm	in		
06Z-446	5/8-18	-06	47,5	1.87	26,2	1.03	6.1	0.24	3/4	2.18

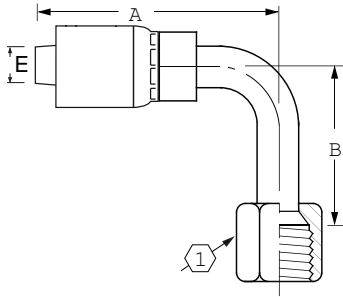

SAE 45° flare male rigid

Z Series Part number	Thd.	Hose size	A		Hose cut-off factor (D)		EØ		2
			mm	in	mm	in	mm	in	
06Z-306	5/8-18	-06	52,3	2.06	31,2	1.23	6,6	0.26	11/16
12Z-312	1 1/16-14	-12	74,7	2.94	47,8	1.88	15,5	0.61	1 1/8

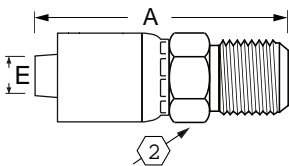

Female ORS swivel

Z Series Part number	Thd.	Hose size	A		Hose cut-off factor (D)		EØ		1	2
			mm	in	mm	in	mm	in		
04Z-S64	9/16-18	-04	49,5	1.95	26,2	1.03	4,3	0.17	11/16	9/16
04Z-S66	11/16-16	-04	51,8	2.04	28,4	1.12	4,3	0.17	13/16	5/8
04Z-S68	13/16-16	-04	52,3	2.06	32,5	1.28	4,1	0.16	13/16	15/16
06Z-S64	9/16-18	-06	54,4	2.14	29,2	1.15	4,3	0.17	11/16	11/16
06Z-S66	11/16-16	-06	56,6	2.23	31,5	1.24	6,6	0.26	13/16	11/16
06Z-S68	13/16-16	-06	58,9	2.32	33,5	1.32	6,6	0.26	15/16	13/16
08Z-S66	11/16-16	-08	63,8	2.51	34,0	1.34	6,6	0.26	13/16	7/8
08Z-S68	13/16-16	-08	67,8	2.67	38,1	1.50	9,7	0.38	15/16	7/8
08Z-S70	1-14	-08	67,1	2.64	37,3	1.47	9,7	0.38	1 1/8	15/16
08Z-S72	13/16-12	-08	71,1	2.80	41,4	1.63	9,7	0.38	1 3/8	1 1/8
10Z-S68	13/16-16	-10	67,8	2.67	38,4	1.51	9,7	0.38	15/16	15/16
10Z-S70	1-14	-10	70,1	2.76	40,9	1.61	12,2	0.48	1 1/8	15/16
10Z-S72	13/16-12	-10	70,9	2.79	41,4	1.63	12,7	0.50	1 3/8	1 1/8
12Z-S70	1-14	-12	71,4	2.81	41,4	1.62	12,2	0.48	1 1/8	1 1/8
12Z-S72	13/16-12	-12	73,9	2.91	43,7	1.72	15,5	0.61	1 3/8	1 1/8
12Z-S76	17/16-12	-12	75,7	2.98	45,5	1.79	15,5	0.61	1 5/8	1 3/8
16Z-S72	13/16-12	-16	81,8	3.22	47,2	1.86	15,5	0.61	1 3/8	1 3/8
16Z-S76	17/16-12	-16	83,6	3.29	49,3	1.94	20,6	0.81	1 5/8	1 3/8
16Z-S80	1 11/16-12	-16	82,6	3.25	48,3	1.90	20,6	0.81	1 7/8	1 5/8
20Z-S80	1 11/16-12	-20	98,8	3.89	59,2	2.33	25,9	1.02	1 7/8	1 3/4
20Z-S84	2-12	-20	94,6	3.88	54,6	2.15	26,7	1.05	2 1/4	1 13/16
24Z-S84	2-12	-24	102,1	4.02	55,6	2.19	32,0	1.26	2 1/4	2

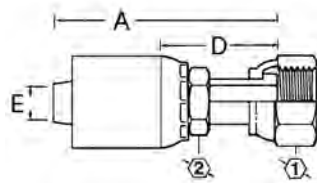

Crimp fittings

'Z' series

H

'Z' series

Female ORS swivel 45° tube elbow

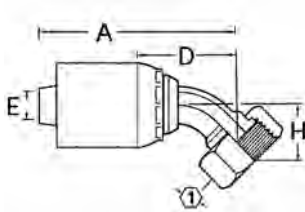

Z Series Part number	Thd.	Hose size	A		Hose cut-off factor (D)		EØ		H		in
			mm	in	mm	in	mm	in	mm	in	
04Z-L64	9/16-18	-04	53,8	2.12	30,5	1.20	4,3	0.17	10,2	0.40	11/16
04Z-L66	11/16-16	-04	58,4	2.30	35,1	1.38	4,3	0.17	10,9	0.43	13/16
06Z-L64	9/16-18	-06	58,4	2.30	33,0	1.30	4,3	0.17	10,4	0.41	11/16
06Z-L66	11/16-16	-06	61,7	2.43	36,3	1.43	6,6	0.26	10,9	0.43	13/16
06Z-L68	13/16-16	-06	69,6	2.74	44,2	1.74	6,6	0.26	15,0	0.59	15/16
08Z-L66	11/16-16	-08	67,3	2.65	37,6	1.48	6,6	0.26	10,9	0.43	13/16
08Z-L68	13/16-16	-08	75,2	2.96	45,5	1.79	9,1	0.36	15,0	0.59	15/16
08Z-L70	1-14	-08	80,8	3.18	51,1	2.01	9,7	0.38	16,5	0.65	1 1/8
08Z-L72	13/16-12	-08	89,2	3.51	59,4	2.34	9,7	0.38	21,1	0.83	13/8
10Z-L70	1-14	-10	77,5	3.05	51,1	2.01	11,4	0.45	16,5	0.65	1 1/8
10Z-L72	13/16-12	-10	89,4	3.52	59,9	2.36	12,7	0.50	21,1	0.83	13/8
12Z-L70	1-14	-12	78,5	3.09	51,8	2.04	11,4	0.45	16,5	0.65	1 1/8
12Z-L72	13/16-12	-12	90,7	3.57	60,5	2.38	14,0	0.55	21,1	0.83	13/8
12Z-L76	17/16-12	-12	102,6	4.04	72,4	2.85	15,5	0.61	23,9	0.94	15/8
16Z-L72	13/16-12	-16	94,5	3.72	60,9	2.40	14,0	0.55	21,1	0.83	13/8
16Z-L76	17/16-12	-16	107,4	4.23	73,2	2.88	19,8	0.78	23,9	0.94	15/8
16Z-L80	1 11/16-12	-16	117,3	4.62	83,8	3.30	20,7	0.81	25,4	1.00	17/8
20Z-L80	1 11/16-12	-20	129,5	5.10	85,6	3.37	25,9	1.02	25,4	1.00	17/8
20Z-L84	2-12	-20	139,4	5.49	95,5	3.76	25,7	1.01	27,2	1.07	2 1/4
24Z-L84	2-12	-24	115,3	4.54	68,8	2.71	32,0	1.26	27,2	1.07	2 1/4

Female ORS swivel short drop 90° tube elbow

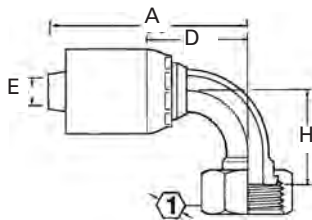

Z Series Part number	Thd.	Hose size	A		Hose cut-off factor (D)		EØ		H		in
			mm	in	mm	in	mm	in	mm	in	
04Z-A24	9/16-18	-04	53,1	2.09	29,7	1.17	4,3	0.17	20,8	0.82	11/16
04Z-A26	11/16-16	-04	56,4	2.22	33,0	1.30	4,3	0.17	22,9	0.90	13/16
06Z-A24	9/16-18	-06	56,1	2.21	30,7	1.21	4,3	0.17	20,8	0.82	11/16
06Z-A26	11/16-16	-06	59,4	2.34	34,0	1.34	6,6	0.26	22,9	0.90	13/16
06Z-A28	13/16-16	-06	66,5	2.62	41,4	1.62	6,6	0.26	29,2	1.15	15/16
08Z-A26	11/16-16	-08	65,0	2.56	35,3	1.39	6,6	0.26	22,9	0.90	13/16
08Z-A28	13/16-16	-08	72,1	2.84	42,4	1.67	9,1	0.36	29,2	1.15	15/16
08Z-A30	1-14	-08	78,0	3.07	48,5	1.91	9,7	0.38	32,3	1.27	1 1/8
08Z-A32	13/16-12	-08	87,6	3.45	57,9	2.28	9,7	0.38	47,8	1.88	13/8
10Z-A30	1-14	-10	78,0	3.07	48,5	1.91	11,4	0.45	32,3	1.27	1 1/8
10Z-A32	13/16-12	-10	87,4	3.44	58,2	2.29	12,7	0.50	47,8	1.88	13/8
12Z-A30	1-14	-12	79,0	3.11	49,0	1.93	11,4	0.45	32,3	1.27	1 1/8
12Z-A32	13/16-12	-12	88,6	3.49	58,4	2.30	14,0	0.55	47,8	1.88	13/8
12Z-A36	17/16-12	-12	102,6	4.04	72,4	2.85	15,5	0.61	56,1	2.21	15/8
16Z-A36	17/16-12	-16	107,2	4.22	72,9	2.87	20,6	0.81	56,1	2.21	15/8
16Z-A40	1 11/16-12	-16	123,2	4.85	89,0	3.50	20,6	0.81	63,8	2.51	17/8
20Z-A40	1 11/16-12	-20	134,6	5.30	90,7	3.57	25,9	1.02	63,8	2.51	17/8
20Z-A44	2-12	-20	109,7	4.32	70,4	2.77	26,6	1.05	68,6	2.70	2 1/4
24Z-A40	1 11/16-12	-24	117,6	4.63	71,4	2.81	32,0	1.26	68,6	2.70	2 1/4
24Z-A44	2-12	-24	117,6	4.63	71,4	2.81	32,0	1.26	68,6	2.70	2 1/4

'Z' series

Female ORS swivel medium drop 90° tube elbow

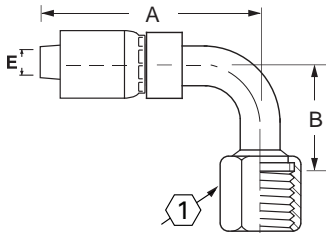

Z Series Part number	Thd.	Hose Size	A		Hose cut-off factor (D)		EØ		1	B
			mm	in	mm	in	mm	in		
04Z-J34	9/16-18	-04	49,5	1.95	29,7	1.17	4,3	0.17	11/16	1.26
04Z-J36	11/16-16	-04	55,1	2.17	32,8	1.29	4,3	0.17	13/16	1.51
04Z-J38	13/16-16	-04	55,9	2.20	35,8	1.41	4,3	0.17	15/16	1.67
06Z-J36	11/16-16	-06	55,1	2.17	34,0	1.34	6,6	0.26	13/16	1.51
06Z-J38	13/16-16	-06	57,4	2.26	36,1	1.42	6,6	0.26	15/16	1.67
08Z-J36	11/16-16	-08	63,0	2.48	37,6	1.48	6,1	0.24	13/16	1.51
08Z-J38	13/16-16	-08	67,6	2.66	42,4	1.67	9,1	0.36	15/16	1.62
08Z-J42	13/16-12	-08	98,3	3.87	72,9	2.87	9,7	0.38	13/8	2.13
10Z-J40	1-14	-10	74,4	2.93	48,5	1.91	11,4	0.45	11/8	1.85
12Z-J40	1-14	-12	67,6	2.66	40,6	1.60	11,4	0.45	11/8	1.78
12Z-J42	13/16-12	-12	85,3	3.36	58,4	2.30	13,9	0.55	13/8	2.28
16Z-J46	17/16-12	-16	106,2	4.18	72,6	2.86	19,8	0.78	15/8	2.78
16Z-J50	111/16-12	-16	141,2	5.56	107,7	4.24	20,6	0.81	17/8	3.06
20Z-J50	111/16-12	-20	148,8	5.86	109,5	4.31	23,6	0.93	17/8	3.06

Female ORS swivel long drop 90° tube elbow

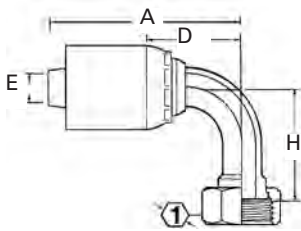

Z Series Part number	Thd.	Hose size	A		Hose cut-off factor (D)		EØ		H		1
			mm	in	mm	in	mm	in	mm	in	
04Z-A64	9/16-18	-04	53,1	2.09	29,7	1.17	4,3	0.17	45,7	1.80	11/16
04Z-A66	11/16-16	-04	56,4	2.22	33,0	1.30	4,3	0.17	54,1	2.13	13/16
04Z-A68	13/16-16	-04	65,8	2.59	42,4	1.67	4,3	0.17	64,8	2.55	15/16
06Z-A66	11/16-16	-06	59,4	2.34	34,0	1.34	6,1	0.24	54,1	2.13	13/16
06Z-A68	13/16-16	-06	68,8	2.71	43,4	1.71	6,6	0.26	64,8	2.55	15/16
08Z-A68	13/16-16	-08	72,9	2.87	43,2	1.70	9,4	0.37	64,8	2.55	15/16
08Z-A70	1-14	-08	78,0	3.07	48,5	1.91	9,7	0.38	70,1	2.76	11/8
10Z-A70	1-14	-10	78,0	3.07	48,5	1.91	11,7	0.46	70,1	2.76	11/8
12Z-A72 *	13/16-12	-12	88,4	3.48	58,2	2.29	14,2	0.56	96,0	3.78	13/8
12Z-A76	17/16-12	-12	102,6	4.04	72,4	2.85	15,5	0.61	114,3	4.50	15/8
16Z-A76**	17/16-12	-16	107,2	4.22	72,6	2.86	19,8	0.78	114,3	4.50	15/8
20Z-A80	111/16-12	-20	134,6	5.30	90,7	3.57	25,7	1.01	129,3	5.09	17/8
20Z-A84	2-12	-20	109,7	4.32	70,4	2.77	26,7	1.05	140,7	5.54	21/4
24Z-A84	2-12	-24	117,6	4.63	71,4	2.81	32,0	1.26	140,7	5.54	21/4

* The 90° long drop tube elbow configuration meets a 3.5:1 burst, based on 4000psi operating pressure.

**The 90° long drop tube elbow configuration meets a 3.7:1 burst, based on 3000psi operating pressure.

Crimp fittings

'Z' series

H

'Z' series

ORS male rigid

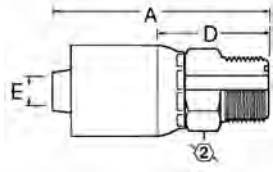

Z Series Part number	Thd.	Hose size	A		Hose cut-off factor (D)		EØ		in
			mm	in	mm	in	mm	in	
04Z-E64	9/16-18	-04	45,2	1.78	21,8	0.86	4,3	0.17	5/8
06Z-E66	11/16-16	-06	50,5	1.99	25,1	0.99	6,6	0.26	3/4
06Z-E68	13/16-16	-06	49,5	1.95	24,1	0.95	6,6	0.26	7/8
08Z-E68	13/16-16	-08	58,4	2.30	28,7	1.13	9,7	0.38	7/8
08Z-E70	1-14	-08	55,1	2.17	29,7	1.17	9,7	0.38	1 1/16
08Z-E72	1 3/16-12	-08	57,7	2.27	32,3	1.27	9,7	0.38	1 1/4
10Z-E70	1-14	-10	57,4	2.26	31,5	1.24	12,2	0.48	1 1/16
10Z-E72	1 3/16-12	-10	57,4	2.26	31,5	1.24	12,7	0.50	1 1/4
12Z-E72	1 3/16-12	-12	66,8	2.63	36,6	1.44	15,5	0.61	1 1/4
12Z-E76	1 7/16-12	-12	64,3	2.53	34,0	1.34	15,5	0.61	1 1/2
16Z-E76	1 7/16-12	-16	75,2	2.96	41,7	1.64	20,7	0.81	1 1/2
20Z-E80	1 11/16-12	-20	85,1	3.35	45,7	1.80	26,2	1.03	1 3/4

Does not include O-ring. See pages J-112-113 for O-ring part number.

Male straight thread O-ring rigid

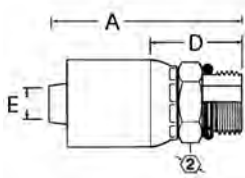

Z Series Part number	Thd.	Hose size	A		Hose cut-off factor (D)		EØ		in
			mm	in	mm	in	mm	in	
04Z-P04	7/16-20	-04	46,7	1.84	23,4	0.92	4,3	0.17	9/16
04Z-P05	1/2-20	-04	46,7	1.84	23,4	0.92	4,3	0.17	5/8
04Z-P06	9/16-18	-04	45,2	1.78	21,8	0.86	4,3	0.17	1 1/16
06Z-P06	9/16-18	-06	50,8	2.00	25,4	1.00	6,6	0.26	1 1/16
06Z-P08	3/4-16	-06	50,0	1.97	24,9	0.98	6,6	0.26	7/8
06Z-P10	7/8-14	-06	47,8	1.88	26,7	1.05	6,6	0.26	1
08Z-P08	3/4-16	-08	59,9	2.36	30,2	1.19	9,7	0.38	7/8
08Z-P10	7/8-14	-08	57,4	2.26	27,7	1.09	9,7	0.38	1
08Z-P12	1 1/16-12	-08	60,7	2.39	31,0	1.22	9,7	0.38	1 1/4
10Z-P08	3/4-16	-10	56,1	2.21	30,2	1.19	12,7	0.50	1 5/16
10Z-P10	7/8-14	-10	59,4	2.34	33,5	1.32	12,7	0.50	1
10Z-P12	1 1/16-12	-10	60,7	2.39	31,2	1.23	12,7	0.50	1 1/4
12Z-P10	7/8-14	-12	64,3	2.53	37,1	1.46	12,2	0.48	1 1/8
12Z-P12	1 1/16-12	-12	62,0	2.44	31,8	1.25	15,5	0.61	1 1/4
12Z-P16	1 5/16-12	-12	65,0	2.56	34,8	1.37	15,5	0.61	1 1/2
16Z-P16	1 5/16-12	-16	69,6	2.74	35,3	1.39	20,8	0.82	1 1/2
20Z-P20	1 5/8-12	-20	92,2	3.63	48,3	1.90	26,7	1.05	1 7/8
24Z-P24	1 7/8-12	-24	92,2	3.63	46,0	1.81	32,0	1.26	2 1/8

See pages J-112-113 for replacement O-rings.

'Z' series

Male straight thread O-ring swivel

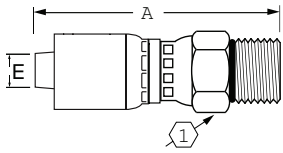

Z Series Part number	Thd.	Hose size	A		Hose cut-off factor (D)		EØ		1
			mm	in	mm	in	mm	in	
04Z-R04	7/16-20	-04	64,0	2.52	40,3	1.59	4,3	0.17	3/4
06Z-R06	9/16-18	-06	69,1	2.72	43,9	1.73	6,6	0.26	7/8
06Z-R08	3/4-16	-08	67,6	2.66	42,4	1.67	6,6	0.26	7/8
08Z-R08	3/4-16	-08	76,5	3.01	46,7	1.84	9,6	0.38	1
08Z-R10	7/8-14	-08	77,0	3.03	47,2	1.86	9,6	0.38	1
08Z-R12	1 1/16-12	-08	88,6	3.49	58,9	2.32	9,6	0.38	1 7/16
10Z-R08	3/4-16	-10	76,7	3.02	47,2	1.86	12,7	0.50	1
12Z-R10	7/8-14	-12	87,1	3.43	56,9	2.24	15,5	0.61	1 7/16

Includes O-ring. See pages J-112-113 for replacement O-rings.

Male straight thread O-ring swivel 90° elbow

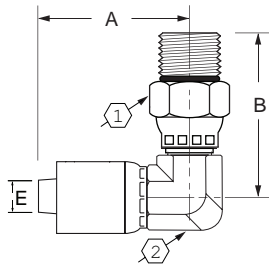

Z Series Part number	Thd.	Hose size	A		Hose cut-off factor (D)		EØ		2	1	B
			mm	in	mm	in	mm	in			
04Z-R66	9/16-18	-04	55,4	2.18	32,0	1.26	4,3	0.17	3/4	7/8	1,87
06Z-R66	9/16-18	-06	59,2	2.33	33,7	1.33	6,6	0.26	3/4	7/8	1,87
06Z-R68	3/4-16	-06	59,2	2.33	33,7	1.33	6,6	0.26	3/4	1	1,93
06Z-R70	7/8-14	-06	59,2	2.33	33,7	1.33	6,6	0.26	3/4	1	1,95
08Z-R68	3/4-16	-08	68,1	2.68	38,3	1.51	9,7	0.38	3/4	1	1,93
08Z-R70	7/8-14	-08	68,1	2.68	38,3	1.51	9,7	0.38	3/4	1	1,97
08Z-R72	1 1/16-12	-08	79,2	3.12	49,5	1.95	9,7	0.38	1 1/16	1 7/16	2,43
12Z-R72	1 1/16-12	-12	94,5	3.72	64,2	2.53	15,5	0.61	32 mm	1 7/16	2,65

Includes O-ring. See pages J-112-113 for replacement O-rings.

Flareless tube rigid Ermeto 7000 series

(with nut and sleeve)

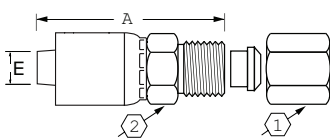

Z Series Part number	Thd.	Tube O.D.	Hose size	A		Hose cut-off factor (D)		EØ		2	1
				mm	in	mm	in	mm	in		
04Z-754	7/16-20	1/4	-04	41,9	1.65	21,8	0.86	4,3	0.17	9/16	9/16
04Z-755	1/2-20	5/16	-04	40,1	1.58	20,3	0.80	4,3	0.17	9/16	5/8
06Z-754	7/16-20	1/4	-06	46,0	1.81	24,6	0.97	6,6	0.26	11/16	9/16
06Z-755	1/2-20	5/16	-06	46,0	1.81	24,6	0.97	5,8	0.23	11/16	5/8
06Z-756	9/16-18	3/8	-06	46,2	1.82	25,2	0.99	6,6	0.26	11/16	11/16
08Z-758	3/4-16	1/2	-08	54,6	2.15	29,5	1.16	9,7	0.38	13/16	7/8
08Z-760	7/8-14	5/8	-08	53,8	2.12	28,5	1.12	9,7	0.38	15/16	1
12Z-762	1 1/16-12	3/4	-12	61,0	2.40	34,0	1.34	15,5	0.61	1 1/8	1 1/4
16Z-766	1 5/8-12	1	-16	96,5	3.80	37,6	1.48	20,6	0.81	1 3/8	1 1/2
20Z-770	1 5/8-12	1 1/4	-20	85,1	3.35	45,7	1.80	26,7	1.05	1 3/4	2

See page J-144 for replacement nuts and sleeves.

Crimp fittings

'Z' series

H

'Z' series

Flareless 45° tube elbow 7000 Ermeto series

(With Nut and Sleeve)

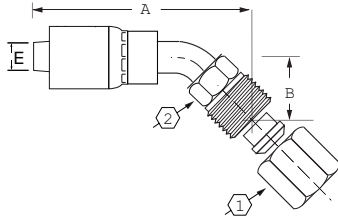

Z Series Part number	Thd. T	Tube O.D.	Hose size	A		Hose cut-off factor (D)		EØ		1	2	B
				mm	in	mm	in	mm	in			
06Z-956	$9/16-18$	$3/8$	-06	62,0	2.44	39,6	1.56	6,6	0.26	$11/16$	$5/8$	0.83

See page J-144 for replacement nuts and sleeves.

Flareless 90° tube elbow 7000 Ermeto series

(With Nut and Sleeve)

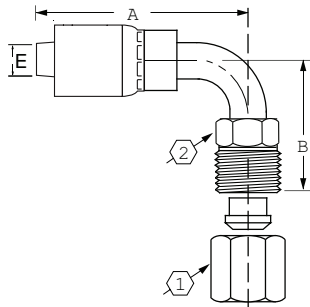

Z Series Part number	Thd. T	Tube O.D.	Hose size	A		Hose cut-off factor (D)		EØ		2	1	B
				mm	in	mm	in	mm	in			
06Z-976	$9/16-18$	$3/8$	-06	52,1	2.05	30,9	1.22	6,6	0.26	$5/8$	$11/16$	1.46

See page J-144 for replacement nuts and sleeves

Inverted male swivel straight

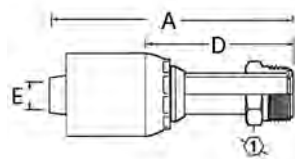

Z Series Part number	Thd.	Hose size	A		Hose cut-off factor (D)		EØ		1
			mm	in	mm	in	mm	in	in
04Z-B03	$3/8-24$	-04	76,2	3.00	55,9	2.20	2,5	0.10	$3/8$
04Z-B04	$7/16-24$	-04	60,7	2.39	37,1	1.46	4,3	0.17	$7/16$
04Z-B05	$1/2-20$	-04	60,7	2.39	37,1	1.46	4,3	0.17	$1/2$
06Z-B04	$7/16-24$	-06	64,3	2.53	38,9	1.53	4,3	0.17	$7/16$
06Z-B05	$1/2-20$	-06	66,0	2.60	40,9	1.61	6,1	0.24	$1/2$
06Z-B06	$5/8-18$	-06	66,0	2.60	40,9	1.61	6,6	0.26	$5/8$
06Z-B07	$11/16-18$	-06	62,2	2.45	40,6	1.60	6,6	0.26	$11/16$
08Z-B08	$3/4-18$	-08	70,9	2.79	41,4	1.62	9,7	0.38	$3/4$
08Z-B10	$7/8-18$	-08	74,7	2.94	49,0	1.93	9,7	0.38	$7/8$

'Z' series

Inverted male swivel 45° tube elbow

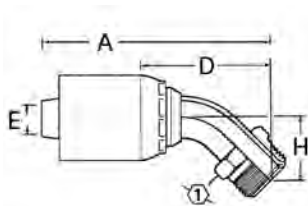

Z Series Part number	Thd.	Hose size	A		Hose cut-off factor (D)		EØ		H		① in
			mm	in	mm	in	mm	in	mm	in	
04Z-B43	3/8-24	-04	69,9	2.75	49,8	1.96	2,5	0.10	17,5	0.69	3/8
04Z-B44	7/16-24	-04	67,8	2.67	44,5	1.75	4,3	0.17	24,4	0.96	7/16
04Z-B45	1/2-20	-04	64,5	2.54	44,5	1.75	4,3	0.17	24,4	0.96	1/2
06Z-B45	1/2-20	-06	69,1	2.72	48,0	1.89	6,1	0.24	24,4	0.96	1/2
06Z-B46	5/8-18	-06	73,2	2.88	48,0	1.89	6,6	0.26	24,4	0.96	5/8
06Z-B47	11/16-18	-06	69,3	2.73	48,0	1.89	6,6	0.26	24,4	0.96	11/16
08Z-B48	3/4-18	-08	78,0	3.07	48,3	1.90	9,7	0.38	23,6	0.93	3/4

Inverted male swivel 90° tube elbow

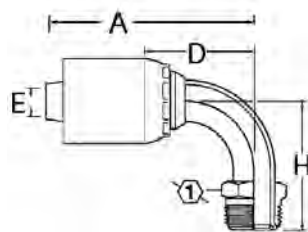

Z Series Part number	Thd.	Hose size	A		Hose cut-off factor (D)		EØ		H		① in
			mm	in	mm	in	mm	in	mm	in	
04Z-B63	3/8-24	-04	53,8	2.12	33,5	1.32	2,5	0.10	27,9	1.06	3/8
04Z-B64	7/16-24	-04	58,2	2.29	34,8	1.37	4,3	0.17	42,3	1.69	7/16
04Z-B65	1/2-20	-04	55,1	2.17	34,8	1.37	4,3	0.17	43,9	1.73	1/2
06Z-B64	7/16-24	-06	57,8	2.28	36,6	1.44	4,3	0.17	42,3	1.69	7/16
06Z-B65	1/2-20	-06	63,8	2.51	38,4	1.51	6,1	0.24	43,9	1.73	1/2
06Z-B66	5/8-18	-06	63,8	2.51	38,4	1.51	6,6	0.26	43,9	1.73	5/8
06Z-B67	11/16-18	-06	62,0	2.44	40,9	1.61	6,6	0.26	43,9	1.73	11/16
08Z-B68	3/4-18	-08	69,3	2.73	39,6	1.56	9,7	0.38	44,5	1.75	3/4

Split flange straight (SAE Code 61)

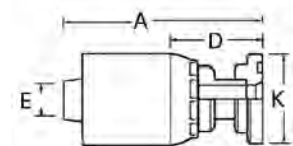

Z Series Part number	Nominal flange size	Thd. flange head Dia. K Ø	Hose size	A		Hose cut-off factor (D)		EØ	
				mm	in	mm	in	mm	in
08Z-G08	1/2	1.19	-08	82,0	3.23	52,3	2.06	9,7	0.38
08Z-G12	3/4	1.50	-08	83,1	3.27	53,3	2.10	9,7	0.38
10Z-G12	3/4	1.50	-10	82,8	3.26	53,3	2.10	12,7	0.50
12Z-G12	3/4	1.50	-12	84,1	3.31	53,8	2.12	15,5	0.61
12Z-G16	1	1.75	-12	84,1	3.31	53,8	2.12	15,5	0.61
12Z-G20	1 1/4	2.00	-12	91,7	3.61	61,5	2.42	15,5	0.61
16Z-G16	1	1.75	-16	88,6	3.49	54,4	2.14	20,8	0.82
16Z-G20	1 1/4	2.00	-16	96,3	3.79	62,0	2.44	20,8	0.82
20Z-G16	1	1.75	-20	100,1	3.94	56,1	2.21	20,8	0.82
20Z-G20	1 1/4	2.00	-20	107,7	4.24	63,8	2.51	26,7	1.05
20Z-G24	1 1/2	2.38	-20	108,5	4.27	64,5	2.54	26,7	1.05
20Z-G32	2	2.81	-20	108,5	4.27	64,5	2.54	25,7	1.01
24Z-G24	1 1/2	2.38	-24	111,8	4.40	65,5	2.58	32,0	1.26
24Z-G32	2	2.81	-24	111,8	4.40	65,5	2.58	30,2	1.19
32Z-G32	2	2.81	-32	117,1	4.61	66,8	2.63	44,5	1.75
32Z-G33	2 1/2	3.31	-32	116,8	4.60	66,8	2.63	44,5	1.75

See pages J-110-112 for split flange kits.

Crimp fittings

'Z' series

H

'Z' series

Split Flange 22.5° tube elbow (SAE Code 61)

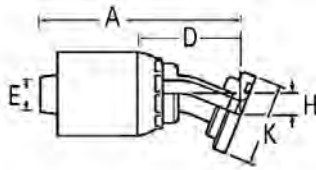

Z Series Part number	Nominal flange size	Flange head Dia. K Ø	Hose size	A		Hose cut-off factor (D)		EØ		H	
				mm	in	mm	in	mm	in	mm	in
16Z-H03	1	1.75	-16	117,9	4.64	83,6	3.29	19,3	0.76	11,4	0.45
16Z-H04	1 1/4	2.00	-16	130,0	5.12	95,8	3.77	19,3	0.76	11,7	0.46
20Z-H04	1 1/4	2.00	-20	141,5	5.57	97,3	3.83	25,7	1.01	11,7	0.46

See pages J-110-112 for split flange kits.

Split Flange 45° tube elbow (SAE Code 61)

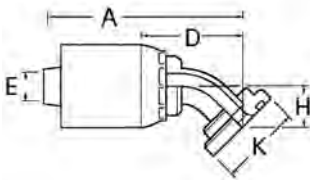

Z Series Part number	Nominal flange size	Flange head Dia. K Ø	Hose size	A		Hose cut-off factor (D)		EØ		H	
				mm	in	mm	in	mm	in	mm	in
08Z-G41	1/2	1.19	-08	79,0	3.11	49,3	1.94	9,4	0.37	19,8	0.78
08Z-G42	3/4	1.50	-08	92,5	3.64	62,7	2.47	9,4	0.37	25,4	1.00
10Z-G42	3/4	1.50	-10	93,5	3.68	64,3	2.53	11,7	0.46	25,4	1.00
12Z-G42	3/4	1.50	-12	93,2	3.67	63,0	2.48	14,7	0.58	25,7	1.01
12Z-G46	1	1.75	-12	105,7	4.16	75,4	2.97	14,7	0.58	26,9	1.06
16Z-G46	1	1.75	-16	110,5	4.35	76,2	3.00	19,3	0.76	26,9	1.06
16Z-G50	1 1/4	2.00	-16	122,2	4.81	87,6	3.45	19,3	0.76	29,2	1.15
20Z-G46	1	1.75	-20	121,9	4.80	77,7	3.06	19,3	0.76	26,9	1.06
20Z-G50	1 1/4	2.00	-20	134,1	5.28	90,2	3.55	25,7	1.01	30,0	1.18
20Z-G54	1 1/2	2.37	-20	146,2	5.76	106,7	4.20	25,7	1.01	35,8	1.41
24Z-G54	1 1/2	2.37	-24	151,6	5.97	107,0	4.25	32,0	1.26	35,8	1.41
24Z-G62	2	2.81	-24	154,2	6.07	108,0	4.25	32,0	1.26	35,8	1.41
32Z-G54	1 1/2	2.37	-32	159,3	6.27	109,0	4.29	32,0	1.26	35,8	1.41
32Z-G62	2	2.81	-32	190,2	7.49	140,2	5.52	44,5	1.75	50,8	2.00

See pages J-110-112 for split flange kits.

'Z' series

Split Flange 60° tube elbow (SAE Code 61)

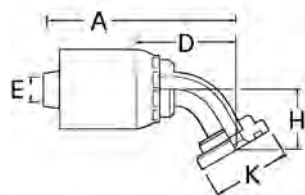

Z Series Part number	Nominal flange size	Flange head Dia. K Ø	Hose size	A		Hose cut-off factor (D)		EØ		H	
				mm	in	mm	in	mm	in	mm	in
16Z-H53	1	1.75	-16	132,5	5.22	98,7	3.89	19,9	0.78	38,3	1.51
24Z-H55	1-1/2	2.37	-24	187,1	7.37	143,4	5.65	32,0	1.26	46,1	1.81

See pages J-110-112 for split flange kits.

Split Flange 67° tube elbow (SAE Code 61)

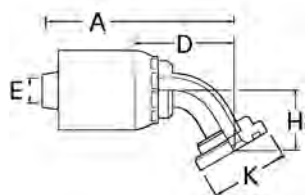

Z Series Part number	Nominal flange size	Flange Head Dia. K Ø	Hose size	A		Hose cut-off factor (D)		EØ		H	
				mm	in	mm	in	mm	in	mm	in
20Z-H60	1-1/4	2.00	-20	157,0	6.18	112,8	4.44	25,7	1.01	46,5	1.83
20Z-H64	1-1/2	2.37	-24	189,7	7.47	143,5	5.65	30,2	1.19	46,0	1.81

Split Flange 90° tube elbow (SAE Code 61)

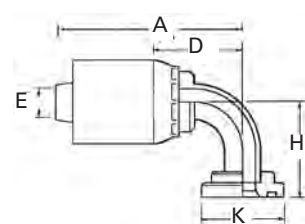

Z Series Part number	Nominal flange size	Flange head Dia. K Ø	Hose size	A		Hose cut-off factor (D)		EØ		H	
				mm	in	mm	in	mm	in	mm	in
08Z-G71	1/2	1.19	-08	72,6	2.86	42,3	1.69	9,4	0.37	41,4	1.63
08Z-G72	3/4	1.50	-08	87,6	3.45	57,9	2.28	9,4	0.37	54,1	2.13
10Z-G72	3/4	1.50	-10	87,4	3.44	58,2	2.29	12,7	0.50	54,1	2.13
12Z-G72	3/4	1.50	-12	88,6	3.49	58,4	2.30	14,7	0.58	54,1	2.13
12Z-G76	1	1.75	-12	102,4	4.03	72,1	2.84	14,7	0.58	60,5	2.38
12Z-G80	1 1/4	2.00	-12	118,6	4.67	88,4	3.48	14,7	0.58	66,5	2.62
16Z-G76	1	1.75	-16	107,2	4.22	72,6	2.86	19,3	0.76	60,5	2.38
16Z-G80	1 1/4	2.00	-16	123,2	4.85	89,0	3.50	19,3	0.76	66,5	2.62
16Z-G84	1 1/2	2.37	-16	142,0	5.59	107,7	4.24	19,3	0.76	79,2	3.12
20Z-G76	1	1.75	-20	118,4	4.66	74,4	2.93	19,3	0.76	60,5	2.38
20Z-G80	1 1/4	2.00	-20	134,6	5.30	90,7	3.57	25,7	1.01	66,5	2.62
20Z-G84	1 1/2	2.37	-20	153,4	6.04	109,4	4.31	26,6	1.05	79,3	3.12
24Z-G80	1 1/4	2.00	-24	137,9	5.43	91,7	3.61	25,7	1.01	66,5	2.62
24Z-G84	1 1/2	2.37	-24	157,0	6.18	110,5	4.35	32,0	1.26	79,3	3.12
24Z-G92	2	2.81	-24	184,9	7.28	138,4	5.45	32,0	1.26	114,3	4.50
32Z-G92	2	2.81	-32	182,9	7.20	119,9	4.72	41,4	1.62	114,3	4.50
32Z-G93	2 1/2	3.31	-32	182,9	7.20	119,9	4.72	41,4	1.62	115,8	4.56

See pages J-110-112 for split flange kits.

Crimp fittings

'Z' series

H

'Z' series

Metric split flange straight (Komatsu, Linkbelt, etc.)

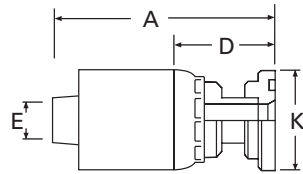

Z Series Part number	Nominal flange size	Flange head Dia. K Ø		Hose Size	A		Hose cut-off factor (D)		EØ	
		mm	in		mm	in	mm	in	mm	in
10Z-G09	5/8	34,2	1.35	-10	94,2	0.16	64,8	2.55	11,5	0.45

Metric split flange 45° tube elbow (Komatsu, Linkbelt, etc.)

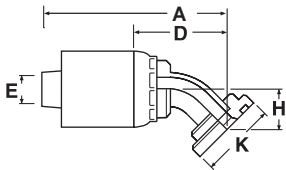

Z Series Part number	Nominal flange size	Flange head Dia. K Ø		Hose size	A		Hose cut-off factor (D)		EØ		H
		mm	in		mm	in	mm	in	mm	in	
10Z-G69	5/8	34,2	1.35	-10	86,1	3.39	56,7	2.23	11,5	0.45	21,8 0.86

Metric split flange 90° tube elbow (Komatsu, Linkbelt, etc.)

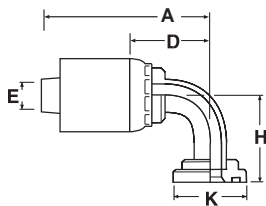

Z Series Part number	Nominal flange size	Flange head Dia. K Ø		Hose size	A		Hose cut-off factor (D)		EØ		H
		mm	in		mm	in	mm	in	mm	in	
10Z-G99	5/8	34,2	1.35	-10	74,6	2.94	48,5	1.91	11,5	0.45	51,3 2.02

'Z' series

READY-LOK® male connector

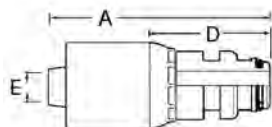

Z Series Part number	Connect. size	Hose size	A		Hose cut-off factor (D)		EØ	
			mm	in	mm	in	mm	in
04Z-04S	1/4	-04	55,4	2.18	32,0	1.26	4,3	0.17
06Z-06S	3/8	-06	58,4	2.30	33,0	1.30	6,6	0.26
06Z-08S	1/2	-06	58,4	2.30	33,0	1.30	6,6	0.26
08Z-08S	1/2	-08	64,0	2.52	34,3	1.35	9,7	0.38
12Z-12S	3/4	-12	65,0	2.56	34,8	1.37	15,5	0.61
16Z-16S	1	-16	74,9	2.95	40,6	1.60	20,6	0.81

(O-ring and backup ring included.)

Standpipe straight tube

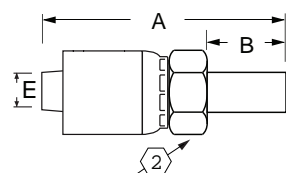

Z Series Part number	Tube O.D.	Hose size	A		Hose cut-off factor (D)		EØ		2	B	
			mm	in	mm	in	mm	in		mm	in
04Z-T04	1/4	-04	55,6	2.19	35,56	1.40	4,3	0.17	9/16	25,4	1.00
06Z-T06	3/8	-06	59,7	2.35	38,61	1.52	6,6	0.26	11/16	25,4	1.00
08Z-T08	1/2	-08	68,3	2.69	43,18	1.70	9,7	0.38	13/16	27,9	1.10
10Z-T10	5/8	-10	71,1	2.80	45,47	1.79	12,7	0.50	15/16	29,2	1.15
12Z-T12	3/4	-12	73,7	2.90	46,74	1.84	15,5	0.61	1 1/8	30,2	1.19
16Z-T16	1	-16	87,1	3.43	53,59	2.11	20,6	0.81	1 3/8	33,5	1.32

See page J-144 for Ermeto nuts and sleeves.

Metric standpipe straight tube

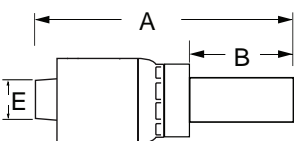

Z Series Part number	Tube O.D.	Hose size	A		Hose cut-off factor (D)		EØ		B	
			mm	in	mm	in	mm	in	mm	in
04Z-38T	8	-04	56,4	2.22	33,0	1.30	4,1	0.16	23	0.91
04Z-40T	10	-04	56,4	2.22	33,0	1.30	4,3	0.17	23	0.91
06Z-40T	10	-06	59,4	2.34	34,3	1.35	6,6	0.26	23	0.91
06Z-42T	12	-06	60,5	2.38	35,0	1.38	6,6	0.26	24	0.95
06Z-44T	14	-06	61,5	2.42	36,1	1.42	6,6	0.26	25	0.98
08Z-45T	15	-08	66,8	2.63	37,1	1.46	9,7	0.38	25	0.98
08Z-46T	16	-08	68,1	2.68	38,4	1.51	9,7	0.38	26	1.02
10Z-48T	18	-10	69,1	2.72	39,6	1.56	12,7	0.05	27	1.06
10Z-50T	20	-10	69,1	2.72	39,6	1.56	12,7	0.50	27	1.06
12Z-52T	22	-12	71,1	2.80	40,9	1.61	15,5	0.61	28	1.10
12Z-55T	25	-12	70,1	2.76	39,9	1.57	15,5	0.61	27	1.06
16Z-58T	28	-16	75,7	2.98	41,4	1.63	20,6	0.81	28	1.10
16Z-60T	30	-16	75,9	2.99	41,7	1.64	20,6	0.81	28	1.10

Please refer to Eaton's Walterscheid metric tube fittings catalog E-MEFI-MC002-E1 (or E-MEFI-MC001-M2 for the global version) for metric nuts and sleeves.

Crimp fittings

'Z' series

H

'Z' series

Pressure washer connection

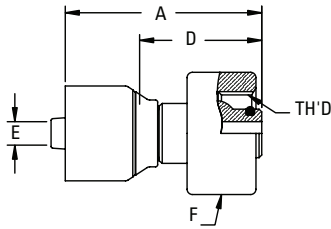

Z Series Part number	Thd.	Hose size	A		Hose cut-off factor (D)		EØ		F Dia.	
			mm	in	mm	in	mm	in	mm	in
04Z-6PW	M22x1.5	-04	55,4	2.18	35,3	1.39	4,2	0.17	34,9	1.38
06Z-6PW	M22x1.5	-06	56,1	2.21	34,9	1.38	6,7	0.26	34,9	1.38

British Standard (BSPP) flat face female swivel

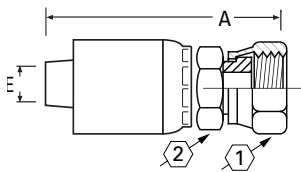

Z Series Part number	Thd.	Hose Size	A		Hose cut-off factor (D)		EØ		2	1
			mm	in	mm	in	mm	in	in	in
06Z-06PA	G 3/8-19	-06	57,2	2.25	36,7	1.42	6,6	0.26	11/16	3/4
06Z-08PA	G 1/2-14	-06	58,7	2.31	37,6	1.48	6,6	0.26	3/4	11/16
08Z-08PA	G 1/2-14	-08	66,8	2.63	41,7	1.64	9,2	0.36	13/16	11/16
08Z-12PA	G 3/4-14	-08	67,1	2.64	41,9	1.65	9,7	0.38	1	11/4
12Z-12PA	G 3/4-14	-12	71,1	2.80	44,2	1.74	15,5	0.61	11/8	11/4

* G as part of thread size is ISO Designation for parallel thread.

British Standard (BSPP) 60° cone female swivel straight

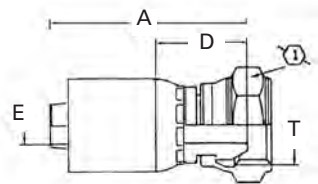

Z Series Part number	Thd. T	Hose Size	A		Hose cut-off factor (D)		EØ		1	
			mm	in	mm	in	mm	in	mm	in
04Z-354	G 1/4-19*	-04	42,3	1.66	18,9	0.74	4,2	0.16	19,0	0.75
04Z-356	G 3/8-19*	-04	45,5	1.79	22,1	0.87	4,3	0.17	22,0	0.87
06Z-356	G 3/8-19*	-06	46,4	1.83	21,1	0.83	6,7	0.26	22,0	0.87
06Z-358	G 1/2-14*	-06	47,9	1.88	22,6	0.89	6,7	0.26	27,0	1.06
08Z-358	G 1/2-14*	-08	53,5	2.11	23,8	0.94	9,6	0.38	27,0	1.06
08Z-360	G 5/8-14*	-08	56,4	2.22	26,7	1.05	9,6	0.38	30,0	1.18
10Z-360	G 5/8-14*	-10	54,1	2.13	24,7	0.97	12,7	0.50	30,0	1.18
12Z-362	G 3/4-14*	-12	55,5	2.18	25,3	1.00	15,5	0.61	32,0	1.26
16Z-366	G 1-11*	-16	62,0	2.44	27,6	1.09	20,7	0.81	41,0	1.61
20Z-370	G 11/4-11*	-20	73,6	2.90	29,6	1.16	26,6	1.05	50,0	1.97

* G as part of thread size is ISO Designation for parallel thread.

'Z' series

British Standard (BSPP) 60° cone female 45° tube elbow

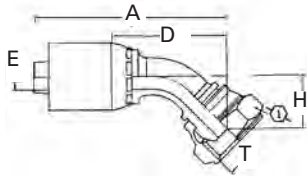

Z Series Part #	Thd. T	Hose size	A		Hose cut-off factor (D)		EØ		H		①	
			mm	in	mm	in	mm	in	mm	in	mm	in
04Z-44P	G 1/4-19*	-04	65,3	2.57	41,9	1.65	4,2	0.16	16,5	0.65	19,0	0.75
06Z-46P	G 3/8-19*	-06	73,8	2.90	48,5	1.91	6,7	0.26	19,0	0.75	22,0	0.87
08Z-48P	G 1/2-14*	-08	91,5	3.60	61,8	2.43	9,6	0.38	24,8	0.98	27,0	1.06
10Z-50P	G 5/8-14*	-10	100,4	3.95	71,0	2.79	12,7	0.50	27,4	1.08	30,0	1.18
12Z-52P	G 3/4-14*	-12	108,8	4.28	78,6	3.09	15,5	0.61	29,4	1.16	32,0	1.26
16Z-56P	G 1-11*	-16	126,8	4.99	92,4	3.09	20,7	0.81	33,2	1.31	41,0	1.61
20Z-60P	G 1 1/4-11*	-20	153,6	6.05	109,6	4.31	26,6	1.05	37,2	1.46	50,0	1.97

* G as part of thread size is ISO Designation for parallel thread.

British Standard (BSPP) 60° cone female 90° tube elbow

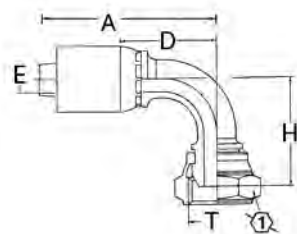

Z Series Part #	Thd. T	Hose size	A		Hose cut-off factor (D)		EØ		H		①	
			mm	in	mm	in	mm	in	mm	in	mm	in
04Z-74P	G 1/4-19*	-04	45,8	1.80	22,4	0.88	4,2	0.16	24,8	0.98	17,0	0.67
06Z-76P	G 3/8-19*	-06	58,9	2.32	33,6	1.32	6,7	0.26	35,0	1.38	22,0	0.87
06Z-78P	G 1/2-14*	-06	75,7	2.98	50,4	1.98	6,7	0.26	47,8	1.88	27,0	1.06
08Z-78P	G 1/2-14*	-08	64,0	2.52	34,3	1.35	9,6	0.38	37,6	1.48	27,0	1.06
08Z-80P	G 5/8-14*	-08	90,7	3.57	61,0	2.40	9,6	0.38	56,3	2.22	27,0	1.06
10Z-80P	G 5/8-14*	-10	90,6	3.57	61,2	1.41	12,7	0.50	56,3	2.22	27,0	1.06
12Z-82P	G 3/4-14*	-12	82,2	3.24	52,0	2.05	15,5	0.61	47,5	1.87	32,0	1.26
16Z-86P	G 1-11*	-16	118,2	4.65	83,8	3.30	20,7	0.81	71,5	2.81	41,0	1.61
20Z-90P	G 1 1/4-11*	-20	146,2	5.75	102,2	4.02	26,6	1.05	82,5	3.25	50,0	1.97

* G as part of thread size is ISO Designation for parallel thread.

British Standard (BSPT) tapered male rigid

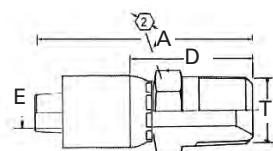

Z Series Part #	Thd. T	Hose size	A		Hose cut-off factor (D)		EØ		②	
			mm	in	mm	in	mm	in	mm	in
04Z-154	R 1/4-19*	-04	50,6	1.99	27,2	1.07	4,2	0.16	14,0	0.55
06Z-156	R 3/8-19*	-06	54,9	2.16	29,6	1.16	6,7	0.26	19,0	0.75
08Z-158	R 1/2-14*	-08	66,2	2.61	36,5	1.44	9,6	0.38	22,0	0.87
12Z-162	R 3/4-14*	-12	71,1	2.80	40,9	1.61	15,5	0.61	30,0	1.18
16Z-166	R 1-11*	-16	81,2	3.20	46,8	1.84	20,7	0.81	36,0	1.42
20Z-170	R 1 1/4-11*	-20	96,2	3.79	52,2	2.05	26,6	1.05	46,0	1.81

* R as part of thread size is ISO Designation for tapered thread.

Crimp fittings

'Z' series

H

'Z' series

British Standard (BSPP)
60° cone male rigid

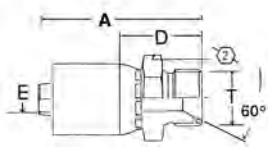

Z Series Part number	Thd. T	Hose size	A		Hose cut-off factor (D)		EØ		②	
			mm	in	mm	in	mm	in	mm	in
04Z-P54	G 1/4-19*	-04	44,3	1.74	20,9	0.82	4,2	0.16	19,0	0.75
06Z-P56	G 3/8-19*	-06	48,4	1.90	23,1	0.91	6,7	0.26	22,0	0.87
08Z-P56	G 3/8-19*	-08	55,9	2.20	26,4	1.04	9,6	0.38	22,0	0.87
06Z-P58	G 1/2-14*	-06	52,4	2.06	27,1	1.07	6,7	0.26	27,0	1.06
08Z-P58	G 1/2-14*	-08	58,0	2.28	28,3	1.11	9,6	0.38	27,0	1.06
10Z-P60	G 5/8-14*	-10	62,0	2.44	35,5	1.25	12,7	0.50	30,0	1.18
12Z-P62	G 3/4-14*	-12	63,1	2.48	32,9	1.29	15,5	0.61	32,0	1.26
16Z-P66	G 1-11*	-16	70,9	2.79	36,5	1.44	20,7	0.81	41,0	1.61
20Z-P67	G 1 1/4-11*	-20	86,1	3.39	42,2	1.66	26,6	1.50	50,0	1.97

* G as part of thread size is ISO Designation for parallel thread.

Female JIS 30° flare
swivel straight

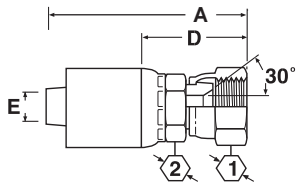

Z Series Part number	Thd.	Hose size	A		Hose cut-off factor (D)		EØ		①		②	
			mm	in	mm	in	mm	in	mm	in	mm	in
04Z-04L	G 1/4-19*	-04	53,2	2.09	29,8	1.17	4,2	0.16	19,0	0.75	19,0	0.75
06Z-06L	G 3/8-19*	-06	59,2	2.33	33,9	1.33	6,7	0.26	22,0	0.87	22,0	0.87
08Z-08L	G 1/2-14*	-08	66,3	2.61	36,6	1.44	9,6	0.38	27,0	1.06	27,0	1.06
10Z-12L	G 3/4-14*	-10	70,6	2.78	45,2	1.78	12,7	0.50	32,0	1.26	36,0	1.42
12Z-12L	G 3/4-14*	-12	73,3	2.88	43,1	1.70	15,5	0.61	32,0	1.26	36,0	1.42
16Z-16L	G 1-11*	-16	83,6	3.29	49,2	1.94	20,7	0.81	41,0	1.61	41,0	1.61
20Z-20L	G 1 1/4-11*	-20	102,1	4.02	58,1	2.29	26,6	1.05	50,0	1.97	46,0	1.81

* G as part of thread size is ISO Designation for parallel thread.

Female swivel
30° flare
(Komatsu, Linkbelt)

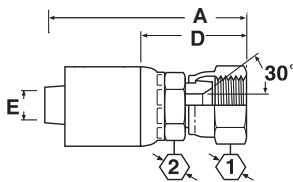

Z Series Part number	Thd.	Hose size	A		Hose cut-off factor (D)		EØ		①		②	
			mm	in	mm	in	mm	in	mm	in	mm	in
04Z-14K	M14 x 1.5	-04	56,1	2.21	32,7	1.29	42,2	1.66	19,0	0.75	19,0	0.75
06Z-18K	M18 x 1.5	-06	60,4	2.38	35,1	1.38	6,7	0.26	24,0	0.94	22,0	0.87
08Z-22K	M22 x 1.5	-08	69,5	2.74	39,8	1.57	9,6	0.38	27,0	1.06	27,0	1.06
10Z-24K	M24 x 1.5	-10	75,4	2.97	46,0	1.81	12,4	0.49	32,0	1.26	30,0	1.18
12Z-30K	M30 x 1.5	-12	81,5	3.21	51,3	2.02	15,5	0.61	36,0	1.42	36,0	1.42
16Z-33K	M33 x 1.5	-16	91,4	3.60	57,0	2.24	20,7	0.81	41,0	1.61	41,0	1.61

'Z' series

Female swivel DIN 24° seat
I. Rh. DKO (Light)

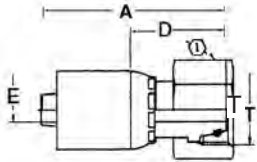

Z Series Part number	Thd. T	Tube O.D.	Hose size	A		Hose cut-off factor (D)		EØ		①	
				mm	in	mm	in	mm	in	mm	in
04Z-06C	M12 x 1.5	6	-04	48,0	1.89	24,6	0.97	4,2	0.16	17,0	0.67
04Z-08C	M14 x 1.5	8	-04	46,0	1.81	22,6	0.89	4,2	0.16	17,0	0.67
04Z-10C	M16 x 1.5	10	-04	48,3	1.90	24,9	0.98	4,3	0.17	19,0	0.75
06Z-10C	M16 x 1.5	10	-06	56,9	2.24	31,6	1.24	6,7	0.26	19,0	0.75
06Z-12C	M18 x 1.5	12	-06	51,2	2.01	25,9	1.02	6,7	0.26	22,0	0.87
08Z-15C	M22 x 1.5	15	-08	58,3	2.29	28,6	1.12	9,6	0.38	27,0	1.06
10Z-18C	M26 x 1.5	18	-10	59,2	2.33	29,8	1.17	12,7	0.50	32,0	1.26
12Z-22C	M30 x 2.0	22	-12	62,5	2.46	32,3	1.27	15,5	0.61	36,0	1.42
16Z-28C	M36 x 2.0	28	-16	68,2	2.68	33,8	1.33	20,7	0.81	41,0	1.61
20Z-35C	M45 x 2.0	35	-20	83,7	3.29	39,7	1.56	26,6	1.05	50,0	1.97

Female swivel DIN 24° seat
45° tube elbow
I. Rh. (Light)

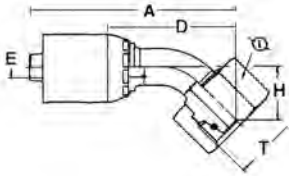

Z Series Part #	Thd. T	Tube O.D.	Hose size	A		Hose cut-off factor (D)		EØ		H		①	
				mm	in	mm	in	mm	in	mm	in	mm	in
04Z-08D	M14 X 1.5	8	-04	6,2	2.46	3,9	1.54	0,4	0.17	17,5	0.69	17,0	0.67
04Z-10D	M16 X 1.5	10	-04	6,5	2.55	4,1	1.63	0,4	0.17	18,4	0.72	19,0	0.75
06Z-10D	M16 X 1.5	10	-06	6,7	2.63	4,1	1.63	0,7	0.26	19,0	0.75	19,0	0.75
06Z-12D	M18 X 1.5	12	-06	7,0	2.76	4,5	1.76	0,7	0.26	17,6	0.69	22,0	0.87
08Z-15D	M22 X 1.5	15	-08	8,3	3.27	5,3	2.10	1,0	0.38	20,5	0.81	27,0	1.06
10Z-18D	M26 X 1.5	18	-10	9,1	3.59	6,2	2.44	1,3	0.50	22,0	0.87	32,0	1.26
12Z-22D	M30 X 2.0	22	-12	10,1	3.97	7,1	2.78	1,5	0.61	24,3	0.96	36,0	1.42
16Z-28D	M36 X 2.0	28	-16	10,3	4.06	6,9	2.70	2,1	0.81	26,6	1.05	41,0	1.61

Female swivel DIN 24° seat
90° tube elbow
I. Rh. (Light)

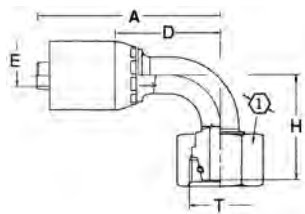

Z Series Part #	Thd. T	Tube O.D.	Hose size	A		Hose cut-off factor (D)		EØ		H		①	
				mm	in	mm	in	mm	in	mm	in	mm	in
04Z-58D	M14 x 1.5	8	-04	51,1	2.01	27,7	1.09	4,3	0.17	31,5	1.24	17,0	0.67
04Z-60D	M16 x 1.5	10	-04	55,4	2.18	32,0	1.26	4,3	0.17	35,5	1.40	19,0	0.75
06Z-60D	M16 x 1.5	10	-06	58,4	2.30	33,5	1.32	6,6	0.26	33,5	1.32	19,0	0.75
06Z-62D	M18 x 1.5	12	-06	59,7	2.35	34,5	1.36	6,6	0.26	34,2	1.35	22,0	0.87
08Z-65D	M22 x 1.5	15	-08	75,2	2.96	45,7	1.80	9,7	0.38	40,0	1.57	27,0	1.06
10Z-68D	M26 x 1.5	18	-10	86,4	3.40	56,9	2.24	12,7	0.50	46,5	1.83	32,0	1.26
12Z-72D	M30 x 2.0	22	-12	92,5	3.64	62,2	2.45	15,5	0.61	50,7	2.00	36,0	1.42
16Z-78D	M36 x 2.0	28	-16	100,1	3.94	65,5	2.58	20,6	0.81	61,0	2.40	41,0	1.61
20Z-85D	M45 x 2.0	35	-20	130,0	5.12	86,1	3.39	26,7	1.05	79,0	3.11	50,0	1.97

Crimp fittings

'Z' series

H

'Z' series

Male DIN 24° seat
l.Rh (Light)

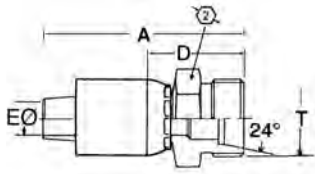

Z Series Part number	Thd. T	Tube O.D.	Hose size	A		Hose cut-off factor (D)		EØ		②	
				mm	in	mm	in	mm	in	mm	in
04Z-06A	M12 x 1.5	6	-04	44,7	1.76	21,3	0.84	4,2	0.16	12,0	0.47
04Z-08A	M14 x 1.5	8	-04	44,5	1.75	21,1	0.83	4,2	0.16	14,0	0.55
04Z-10A	M16 X 1.5	10	-04	46,0	1.81	22,6	0.89	4,3	0.17	17,0	0.67
06Z-10A	M16 x 1.5	10	-06	52,0	2.05	26,7	1.05	6,7	0.26	17,0	0.67
06Z-12A	M18 x 1.5	12	-06	49,0	1.93	23,7	0.93	6,7	0.26	19,0	0.75
08Z-15A	M22 x 1.5	15	-08	56,0	2.20	26,3	1.03	9,6	0.38	24,0	0.94
10Z-18A	M26 x 1.5	18	-10	56,0	2.20	26,6	1.05	12,7	0.50	27,0	1.06
12Z-22A	M30 x 2.0	22	-12	62,0	2.44	31,8	1.25	15,5	0.61	32,0	1.26
16Z-28A	M36 x 2.0	28	-16	66,0	2.60	31,6	1.24	20,7	0.81	41,0	1.61
20Z-35A	M45 x 2.0	35	-20	79,4	3.12	35,4	1.39	26,6	1.05	46,0	1.81

Female swivel
DIN 24° seat
s.Rh DKO (Heavy)

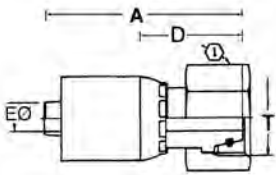

Z Series Part number	Thd. T	Tube O.D.	Hose size	A		Hose cut-off factor (D)		EØ		①	
				mm	in	mm	in	mm	in	mm	in
04Z-58C	M16 x 1.5	8	-04	49,6	1.95	26,2	1.03	4,2	0.16	19,0	0.75
04Z-60C	M18 x 1.5	10	-04	50,8	2.00	27,4	1.08	4,2	0.16	22,0	0.87
04Z-62C	M20 X 1.5	12	-04	50,8	2.00	27,4	1.08	4,3	0.17	24,0	0.94
06Z-60C	M18 X 1.5	10	-06	52,8	2.08	27,7	1.09	6,6	0.26	27,0	1.06
06Z-62C	M20 x 1.5	12	-06	53,8	2.12	28,5	1.12	6,7	0.26	24,0	0.94
06Z-64C	M22 x 1.5	14	-06	56,9	2.24	31,6	1.24	6,7	0.26	27,0	1.06
08Z-64C	M22 x 1.5	14	-08	55,2	2.17	25,5	1.00	9,6	0.38	27,0	1.06
08Z-66C	M24 x 1.5	16	-08	62,4	2.46	32,7	1.29	9,6	0.38	30,0	1.18
10Z-70C	M30 x 2.0	20	-10	66,9	2.63	37,5	1.48	12,7	0.50	36,0	1.42
12Z-75C	M36 x 2.0	25	-12	72,0	2.83	41,8	1.64	15,5	0.61	46,0	1.81
12Z-70C	M30 X 2.0	20	-12	60,2	2.37	30,2	1.19	14,0	0.55	36,0	1.42
16Z-80C	M42 x 2.0	30	-16	78,5	3.09	44,1	1.44	20,7	0.81	50,0	1.97
20Z-88C	M52 X 2.0	38	-20	93,7	3.69	49,8	1.96	26,6	1.05	60,0	2,36

Female swivel
DIN 24° seat 45° tube elbow
s.Rh (Heavy)

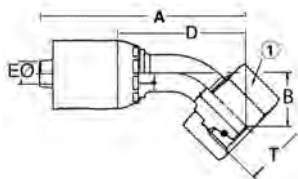

Z Series Part number	Thd. T	Tube O.D.	Hose size	A		Hose cut-off factor (D)		EØ		H		①	
				mm	in	mm	in	mm	in	mm	in	mm	in
04Z-08E	M16 x 1.5	8	-04	56,4	2.22	33,0	1.30	4,2	0.16	15,0	0.59	19,0	0.75
04Z-10E	M18 x 1.5	10	-04	61,4	2.42	38,0	1.50	4,2	0.16	17,0	0.67	22,0	0.87
06Z-12E	M20 x 1.5	12	-06	68,3	2.69	43,0	1.69	6,7	0.26	19,0	0.75	24,0	0.94
06Z-14E	M22 x 1.5	14	-06	68,8	2.71	43,5	1.71	6,7	0.26	20,0	0.79	27,0	1.06
08Z-16E	M24 x 1.5	16	-08	79,7	3.14	50,0	1.97	9,6	0.38	23,0	0.90	30,0	1.18
10Z-20E	M30 x 2.0	20	-10	89,3	3.51	59,9	2.36	12,7	0.50	26,0	1.02	36,0	1.42
12Z-25E	M36 x 2.0	25	-12	107,4	4.23	77,2	3.04	15,5	0.61	32,5	1.28	46,0	1.81
16Z-30E	M42 x 2.0	30	-16	121,4	4.78	87,0	3.42	20,7	0.81	37,5	1.48	55,0	2.16

'Z' series

**Female swivel
DIN 24° seat 90° tube elbow**
s.Rh DKO (Heavy)

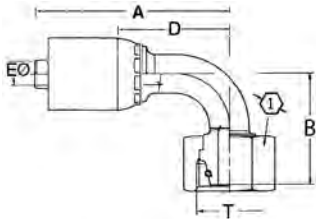

Z Series Part number	Thd. T	Tube O.D.	Hose size	A		Hose cut-off factor (D)		EØ		H		①	
				mm	in	mm	in	mm	in	mm	in	mm	in
04Z-58E	M16 x 1.5	8	-04	54,0	2.13	30,6	1.20	4,2	0.16	28,6	1.13	19,0	0.75
04Z-60E	M18 x 1.5	10	-04	54,5	2.14	31,0	1.22	4,2	0.16	33,5	1.32	22,0	0.87
06Z-60E	M18 x 1.5	10	-06	63,9	2.52	38,6	1.52	6,7	0.26	33,5	1.32	22,0	0.87
06Z-62E	M20 x 1.5	12	-06	60,3	2.37	35,0	1.38	6,7	0.26	35,0	1.38	24,0	0.94
06Z-64E	M22 x 1.5	14	-06	63,8	2.51	38,5	1.51	6,7	0.26	42,0	1.65	27,0	1.06
08Z-66E	M24 x 1.5	16	-08	73,7	2.90	44,0	1.73	9,6	0.38	49,0	1.93	30,0	1.18
10Z-70E	M30 x 2.0	20	-10	82,0	3.23	52,6	2.07	12,7	0.50	53,5	2.11	36,0	1.42
12Z-75E	M36 x 2.0	25	-12	93,0	3.66	62,8	2.47	15,5	0.61	64,5	2.54	46,0	1.81
16Z-80E	M42 x 2.0	30	-16	104,0	4.09	69,6	2.74	20,7	0.81	74,0	2.91	50,0	1.97

Male DIN 24° seat
s.Rh (Heavy)

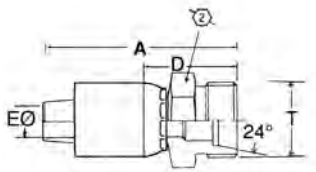

Z Series Part number	Thd. T	Tube O.D.	Hose size	A		Hose cut-off factor (D)		EØ		②	
				mm	in	mm	in	mm	in	mm	in
04Z-08F	M16 x 1.5	8	-04	47,5	1.87	24,1	0.95	4,2	0.16	17,0	0.67
04Z-10F	M18 x 1.5	10	-04	40,7	1.60	23,6	0.93	4,2	0.16	19,0	0.75
06Z-10F	M18 X 1.5	10	-06	49,5	1.95	24,1	0.95	6,7	0.26	19,0	0.75
06Z-12F	M20 x 1.5	12	-06	50,3	1.98	25,0	0.98	6,7	0.26	22,0	0.87
06Z-14F	M22 x 1.5	14	-06	52,6	2.07	27,3	1.07	6,7	0.26	24,0	0.94
08Z-16F	M24 x 1.5	16	-08	58,0	2.28	28,3	1.11	9,6	0.38	27,0	1.06
10Z-20F	M30 x 2.0	20	-10	62,0	2.44	32,6	1.28	12,7	0.50	32,0	1.26
12Z-20F	M30 X 2.0	20	-12	57,7	2.27	30,7	1.21	15,5	0.61	32,0	1.26
12Z-25F	M36 x 2.0	25	-12	65,5	2.58	35,3	1.39	15,5	0.61	41,0	1.61
16Z-30F	M42 x 2.0	30	-16	72,3	2.85	37,9	1.49	20,7	0.81	46,0	1.81

Crimp fittings

'Z' series

H

'Z' series

STC male straight

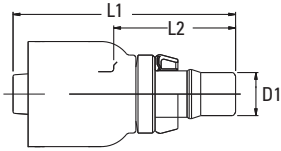

Z Series Part number	D1		L1		L2	
	mm	in	mm	in	mm	in
04Z-BC06	4,2	0.17	52,4	2.06	29,0	1.14
06Z-BC06	6,7	0.26	55,5	2.19	30,2	1.19
06Z-BC08	6,7	0.26	60,6	2.39	35,4	1.39
08Z-BC08	9,6	0.38	66,3	2.61	36,6	1.44
10Z-BC10	12,8	0.50	69,0	2.72	39,6	1.56
12Z-BC12	15,5	0.61	74,6	2.94	44,4	1.75
16Z-BC16	0,7	0.82	83,7	3.30	49,3	1.94

STC male 45° tube elbow

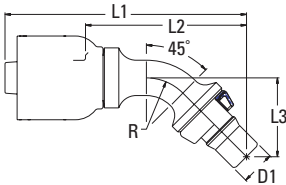

Z Series Part number	D1		L1		L2		L3		R	
	mm	in	mm	in	mm	in	mm	in	mm	in
04Z-BC46	4,2	0.17	69,8	2.75	46,4	1.83	22,2	0.86	14,0	0.55
06Z-BC46	6,7	0.26	72,9	2.87	47,6	1.87	22,2	0.87	14,0	0.55
08Z-BC48	8,8	0.35	89,9	3.54	60,2	2.37	29,6	1.17	19,0	0.75
10Z-BC50	11,5	0.45	97,8	3.85	68,4	2.69	33,6	1.32	22,0	0.87
12Z-BC52	13,9	0.55	110,2	4.34	80,0	3.15	40,7	1.60	31,0	1.22

STC male 90° tube elbow

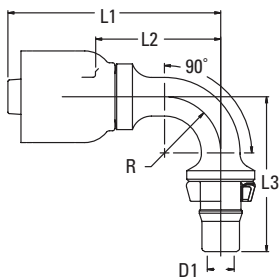

Z Series Part number	D1		L1		L2		L3		R	
	mm	in	mm	in	mm	in	mm	in	mm	in
06Z-BC66	6,7	0.26	59,3	2.33	34,0	1.34	39,6	1.56	14,0	0.55
06Z-BC68	6,7	0.26	66,4	2.61	41,1	1.62	53,0	2.09	19,0	0.75
08Z-BC68	8,8	0.35	72,0	2.83	42,3	1.67	53,0	2.09	19,0	0.75
10Z-BC70	11,5	0.45	77,9	3.07	48,5	1.91	60,4	2.36	22,0	0.87
12Z-BC72	13,9	0.55	88,7	3.49	58,5	2.30	75,7	2.98	31,0	1.22
16Z-BC76	19,9	0.78	107,3	4.22	72,9	2.87	90,0	3.54	38,0	1.50

STC male 90° long drop elbow

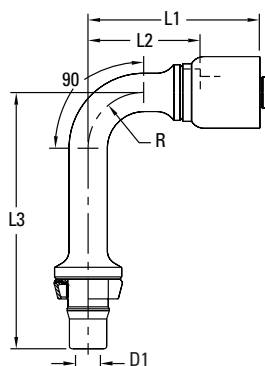

Z Series Part number	D1		L1		L2		L3		R	
	mm	in	mm	in	mm	in	mm	in	mm	in
06Z-BC86	6,4	0.25	59,3	2.33	34,0	1.34	70,6	2.78	14,0	0.55
08Z-BC88	9,1	0.36	72,0	2.84	42,3	1.67	88,1	3.46	19,0	0.75
12Z-BC92	13,9	0.55	88,7	3.49	58,5	2.30	123,7	4.87	31,0	1.22

How to order 4S/6S fittings

Accurate processing and prompt delivery of your order depends on easy identification of your requirements. Please order Eaton brand parts using correct part numbers as described in this catalog. Inquiries and orders should be directed to your Eaton Fluid Conveyance Distributor or:

Eaton

14615 Lone Oak Rd.
Eden Prairie, MN 55344
1-952-937-9800
1-888-258-0222
Fax: 952-974-7722
www.eaton.com/hydraulics

Part numbers and dash sizes

Dash size designates the nominal size of 16ths of an inch or tube O.D. in mm. This number immediately follows the part number and is separated from it with a dash.

Dimensions

Dimensions given in this catalog for Eaton products are approximate and should be used for reference only. Exact dimensional information for a given product is subject to change and varying tolerances; contact Eaton directly for full current information.

Globally standardized pressure ratings

Eaton has standardized hose burst and operating pressure ratings in cataloging, worldwide. This move toward standardization will slightly alter some of the pressure ratings listed for hoses in this catalog as pressures are rounded off. This is a paper conversion only. This action has no effect on the actual testing and certification of Eaton hoses to stringent product standards.

Label Set - FF91420

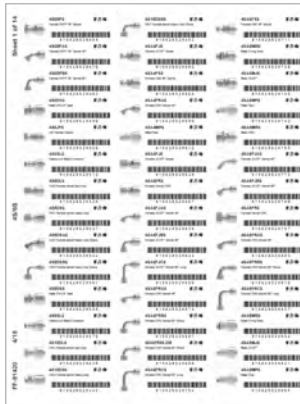

Warning

Hose assemblies

Eaton manufactures the terminal ends of our hose fittings to the appropriate requirements established by the SAE. Therefore, the performance ratings of these hose fittings meet or exceed the SAE requirements. It is possible to order a hose assembly with a fitting terminal end that has a performance rating lower than the hose rating.

When ordering hose assemblies, please keep the connecting end performance rating in mind since this may affect overall hose assembly performance. Hose assembly components (hose and fittings) are easily assembled in the field. However, factory assembled reusable and crimped hose assemblies are available. For complete information, contact Eaton.

Socket data

Markings on crimp fittings

Use of correct Eaton fitting with a given Eaton hose is essential for proper assembly and performance. All Eaton 4S/6S fittings are marked with the product group, 4S or 6S, and the dash size.

Global identification marking

Global non-skive fitting sockets for four-spiral and six-spiral hose in all sizes have four or six rings plus a scribe mark and either 4S-size or 6S-size etched on the socket. Global hose fittings are identified with an Eaton trademark and the hose dash size. In addition, global sockets are identified with the following:

Identification marking	Fitting style	Hose/Socket description
4 rings 1 scribe mark and 4S socket 4S-(size)	Spiral non-skive	Four spiral wire hose
6 rings 1 scribe mark and 6S socket 6S-(size)	Spiral non-skive	Six spiral wire hose

4S Fitting



4S Socket



6S Fitting



6S Socket



Weatherhead catalog hose fitting size reference

Example

SAE JIC/37° Female Swivel – Straight for “4S” series

- Eaton global fitting part # 4SA12FJ16 (must order part using this part #)
- Weatherhead size reference # 16-612 (for reference only – cannot order part using this number)
 - Hose size: -16
 - Fitting terminal end size & type: -612

View of fitting section in catalog:

4SA12FJ16 (16-612)

Example

SAE Code 61 Flange – Straight for “6S” series

- Eaton global fitting part # 6S32FL24 (must order part using this part #)
- Weatherhead size reference # 24-G32 (for reference only – cannot order part using this number)
 - Hose size: -24
 - Fitting terminal end size & type: -G32

View of fitting section in catalog:

6S32FL24 (24-G32)

Crimp fittings

Spiral hose fittings
(4S/6S Series)

H Eaton's 4S/6S hose fitting part numbering system

Global crimp nipples/fittings

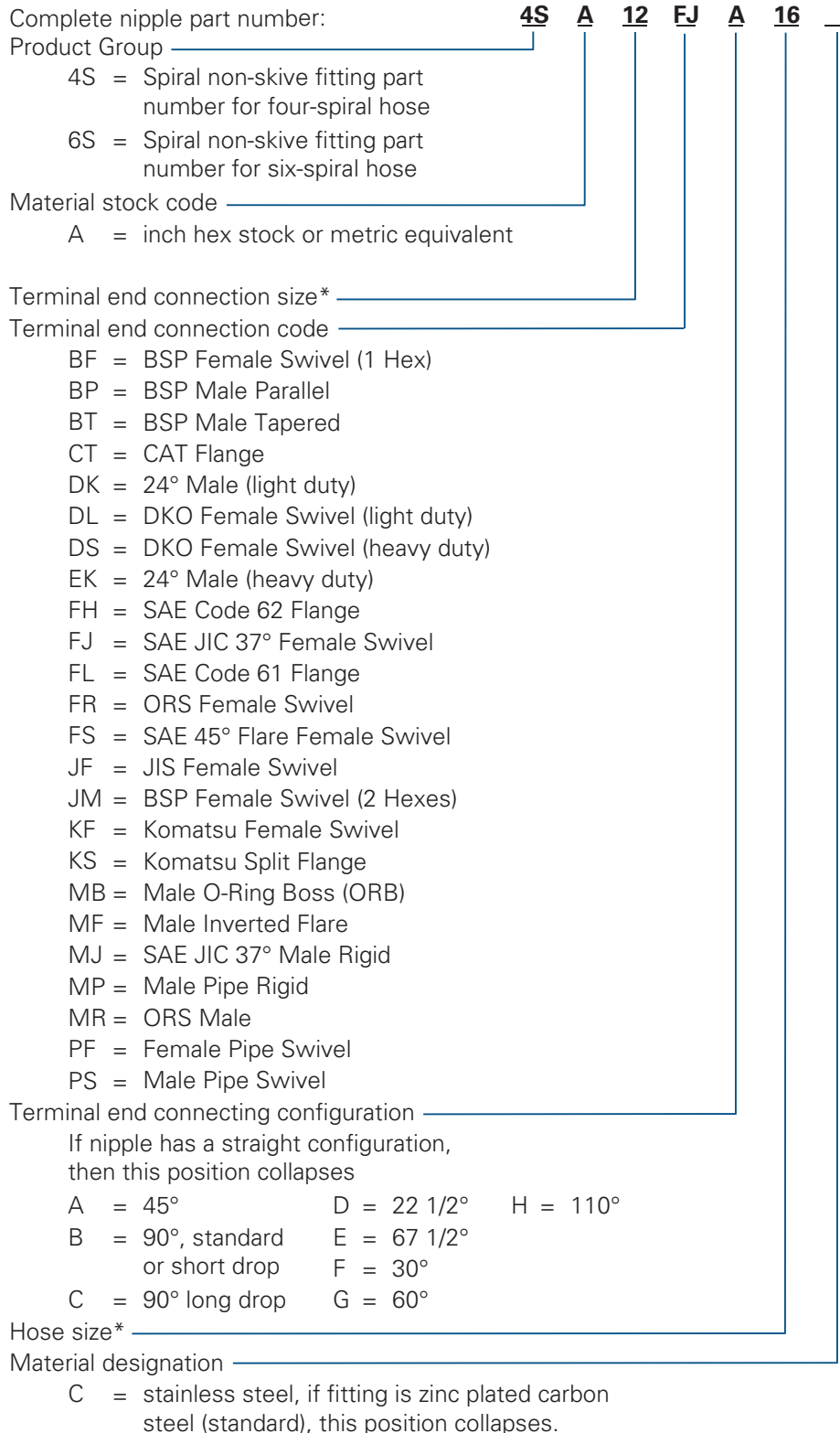

* When ordering sizes 3, 4, 5, 6 and 8 the part number requires only single digits

Hose fitting pressure chart for 4S/6S fittings only

Thread style pressure performance

Eaton closely follows industry standards in design and in application recommendations. A key principle within ISO, SAE and other standards bodies is that the **MAXIMUM WORKING PRESSURE OF THE HOSE OR ADAPTER ASSEMBLY IS THE LESSER OF THE HOSE AND END**

CONNECTOR(S) USED. The first table below provides excerpts from standard Industry pressure rating charts for connector types as Published by SAE (Society of Automotive Engineers.)

Note: The tables below are applicable for low carbon free machining steels typically used in Fluid Power connections. For port type connections, the material and design of the port must be considered and may reduce expected strength. For high pressure applications Eaton recommends the use of more robust connector designs such as Code 62 flange or O-Ring face seal (ORS).

Selected SAE pressure ratings

Dash size	Inch size	37° JIC SAE J514	Pipe SAE J476	Male ORB SAE J1926 ORS adapt.	Male ORB SAE J1926 non-ORS adapt.	Adjustable ORB SAE J1926 ORS adapt.	Adjustable ORB SAE J1926 non-ORS adapt.	ORS SAEJ1453	Male flareless SAE J514	Code 61 SAE J518	Code 62 SAE J518
-6	3/8	4000	4000	9000	5000	6000	4000	9000	4000	-	-
-8	1/2	4000	3000	9000	4500	6000	4000	9000	4000	5000	6000
-10	5/8	3000	-	9000	3500	6000	3000	6000	3000	-	-
-12	3/4	3000	2500	6000	3500	6000	3000	6000	3000	5000	6000
-14	7/8	2500	-	6000	3000	6000	2500	6000	2500	-	-
-16	1	2500	2000	6000	3000	5000	2500	6000	2500	5000	6000
-20	1 1/4	2000	1150	4000	2500	4000	2000	3600	2000	4000	6000
-24	1 1/2	1500	1000	4000	2500	3000	2000	3600	1500	3000	6000
-32	2	1125	1000	3000	2000	2500	1500	3000	1125	3000	6000

International pressure rating charts

Maximum working pressure (PSI)

Hose fitting connection	Hose fitting size									
	-04	-05	-06	-08	-10	-12	-16	-20	-24	-32
Male British Pipe (BSP)	5000	-	4000	4000	3500	4000	3500	2500	2,000	2000
Female British Pipe (BSP)	5000	-	4000	4000	3500	4000	3500	2500	2,000	2000
Female Pipe (JIS)	5000	-	5000	5000	-	4000	4000	-	-	-

Maximum working pressure (PSI)

Hose fitting Connection	Hose fitting size									
	-06	-08	-10	-12	-15	-18	-22	-28	-35	-42
DIN light	3625	3625	3625	3625	3625	2325	2325	1450	1450	1450

Crimp fittings

Spiral hose fittings
(4S/6S Series)

To determine the correct length of hose, subtract the cut-off factor for each end fitting from the overall length of assembly.

Hose fitting pressure chart for 4S/6S fittings only

All Eaton components

With higher pressures it is critical to know the construction materials and manufacturing method to ensure performance. When all components in a system are Eaton supplied, for example an Eaton hose fitting is mated with an Eaton adapter or tube fitting, the combination may be used at higher pressures with confidence. These higher ratings are noted in the chart below.

MAXIMUM WORKING PRESSURE OF THE HOSE OR ADAPTER ASSEMBLY IS THE LESSER OF THE HOSE AND END CONNECTOR(S) USED.

All Eaton pressure ratings

Dash size	Inch size	37° JIC	Male pipe	Female pipe	Male ORB ORS adapter	Male ORB non-ORS adapter	Adjustable ORB ORS adapter	Adjustable ORB non-ORS adapter	ORB	Male flareless	Code 61	Code 62	STC
-6	3/8	5000	8000	4000	9000	5000	6000	4000	9000	4000	-	-	5000
-8	1/2	4000	6000	4000	9000	4500	6000	4000	9000	4000	5000	6000	4250
-10	5/8	3800	-	-	9000	3500	6000	3000	9000	3000	-	-	4000
-12	3/4	5000	5000	3500	6000	3500	6000	3000	6000	3000	5000	6000	4000
-14	7/8	5000	-	-	6000	3000	6000	2500	-	2500	-	-	-
-16	1	5000	4000	3000	6000	3000	5000	2500	6000	2500	5000	6000	4000
-20	1 1/4	5000	3000	2000	4000	2500	4000	2000	4500	2000	4000	6000	-
-24	1 1/2	2100	2000	1500	4000	2500	3000	2000	4000	1500	3000	6000	-
-32	2	1750	2000	1500	3000	2000	2500	1500	3000	1125	3000	6000	-

1) These ratings are based on both brazed and one piece construction, one-piece pressures could be increased. Please contact Eaton in these situations.

2) This rating is for thin walled adapters or fittings, the use of manifolds or oversized female ports would allow full rated male pressures.

Note:

- Eaton fittings are tested to industry standards and beyond to insure a long life. All assemblies listed in the All "Eaton Pressure Ratings" table have passed impulse testing at 133% of operating pressure up to 1 million cycles and meet a 4:1 burst pressure.
- When assembled with all Eaton components, all SAE 37° JIC male and female terminal ends in the 4S & 6S product line are rated at the pressures listed in the table above and have passed one million impulse cycles at 133% of this pressure. All straight configurations achieve a 4:1 burst. The 45° and 90° elbow configurations in the -12 size meet a 3.2:1 burst the 45° and 90° elbow configurations in the -16 size achieve a 2.8:1 burst; the 45° and 90° elbow configurations in the -20 size meet a 4:1 burst and the 45° and 90° elbow configurations in the -24 size meet a 2.4:1 burst.

Design and Application

Eaton's Fluid Conveyance engineering and support teams have many decades of experience in designing, manufacturing and servicing hydraulic and other fluid conveyance systems globally. Eaton's product line is designed as a comprehensive collection of hose, fittings, connectors, couplings and accessories that allow a system designer to select components to complete a fluid power system or a service technician to replace a component with confidence. The individual

product specifications, the above pressure ratings and other technical information are intended as supporting guidelines for system design and service needs and are not to be construed as a guarantee of performance of the system or of individual Eaton components. Eaton provides comprehensive technical support so please call with questions about pressure needs not covered by these charts or for specific application support.

4S/6S Fitting series

4S Fittings

For use with hoses:

H430-6,-8,-10,-12,-16,-20,-24,-32;
H430R-6,-8,-10,-12,-16,-20,-24,-32;
H464-12,-16,-20,-24,-32;
H471-12,-16,-20,-24; EC600-12,-16;
EC525-12,-16,-20,-24,-32; EC810-12,-16

6S Fittings

For use with hoses:

H471-32;
EC600-20;
EC810-20,-24,-32

Male Pipe NPTF - Rigid (MP)

Straight

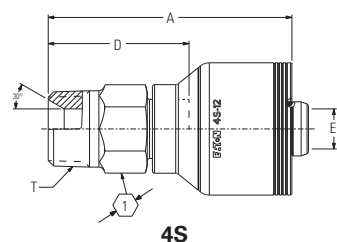

4S

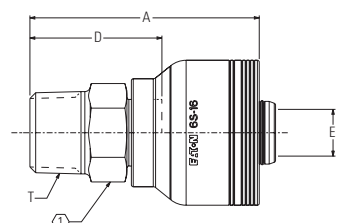

6S

Part Number	Terminal End	Hose Size		Thread	A		D		E Ø		
	Dash size	DN	Dash size	in	mm	in	mm	in	mm	in	
4SA4MP6 (06-104)	-4	10	-6	1/4-18	51,4	2.02	30,1	1.18	6,7	0.26	11/16
4SA6MP6 (06-106)	-6	10	-6	3/8-18	55,0	2.17	32,2	1.27	6,7	0.26	11/16
4SA8MP6 (06-108)	-8	10	-6	1/2-14	53,7	2.11	32,4	1.28	6,7	0.26	7/8
4SA4MP8	-4	12	-8	1/4-18	58,5	2.30	31,3	1.23	7,7	0.30	13/16
4SA6MP8	-6	12	-8	3/8-18	60,8	2.39	33,6	1.32	9,6	0.38	13/16
4SA8MP8 (08-108)	-8	12	-8	1/2-14	71,0	2.80	40,6	1.60	9,6	0.38	7/8
4SA12MP8 (08-112)	-12	12	-8	3/4-14	62,6	2.46	35,4	1.39	9,6	0.38	1 1/16
4SA8MP10 (10-108)	-8	16	-10	1/2-14	66,2	2.61	40,1	1.58	12,8	0.50	15/16
4SA12MP10 (10-112)	-12	16	-10	3/4-14	61,7	2.43	35,6	1.40	12,8	0.50	1 1/16
4SA8MP12 (12-108)	-8	19	-12	1/2-14	84,6	3.33	48,4	1.90	14,2	0.56	7/8
4SA12MP12 (12-112)	-12	19	-12	3/4-14	85,9	3.38	49,6	1.95	14,2	0.56	1 1/16
4SA16MP12 (12-116)	-16	19	-12	1-11 1/2	84,8	3.34	48,6	1.91	14,2	0.56	1 3/8
4SA12MP16 (16-112)	-12	25	-16	3/4-14	89,1	3.51	49,2	1.94	19,2	0.75	1 3/8
4SA16MP16 (16-116)	-16	25	-16	1-11 1/2	94,0	3.70	54,1	2.13	19,2	0.75	1 3/8
4SA20MP16 (16-120)	-20	25	-16	1 1/4-11 1/2	90,4	3.56	50,5	1.99	19,2	0.75	1 11/16
4SA16MP20 (20-116)	-16	31	-20	1-11 1/2	107,6	4.24	52,5	2.07	25,2	0.99	1 7/16
4SA20MP20 (20-120)	-20	31	-20	1 1/4-11 1/2	119,6	4.71	64,4	2.54	25,2	0.99	1 11/16
4SA24MP24 (24-124)	-24	38	-24	1 1/2-11 1/2	143,2	5.64	65,2	2.57	31,1	1.22	2
4SA32MP32 (32-132)	-32	51	-32	2-11 1/2	150,1	5.91	72,1	2.84	42,1	1.66	2 1/2
6S	Dash size	DN	Dash size	in	mm	in	mm	in	mm	in	in
6SA20MP20 (20-120)	-20	31	-20	1 1/4-11 1/2	120,4	4.74	64,4	2.54	25,2	0.99	1 11/16
6SA24MP24 (24-124)	-24	38	-24	1 1/2-11 1/2	143,2	5.64	65,2	2.57	31,1	1.22	2
6SA32MP32 (32-132)	-32	51	-32	2-11 1/2	150,1	5.91	72,1	2.84	42,1	1.66	2 1/2

Crimp fittings

Spiral hose fittings
(4S/6S Series)

4S Fittings

For use with hoses:

H430-6,-8,-10,-12,-16,-20,-24,-32;
H430R-6,-8,-10,-12,-16,-20,-24,-32;
H464-12,-16,-20,-24,-32;
H471-12,-16,-20,-24; EC600-12,-16;
EC525-12,-16,-20,-24,-32; EC810-12,-16

6S Fittings

For use with hoses:

H471-32;
EC600-20;
EC810-20,-24,-32

H

Male Pipe NPTF Swivel (PS)

Straight

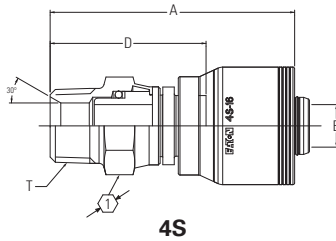

4S

Part Number	Terminal End	Hose Size		Thread	A		D Cut Off Factor		E Ø		in
		DN	Dash size		in	mm	in	mm	in	mm	
4SA16PS16 (16-J16)	-16	25	-16	1-11 1/2	110,2	4.34	70,1	2.76	19,2	0.75	1 1/2

Male JIC/37° - Rigid (MJ)

Straight

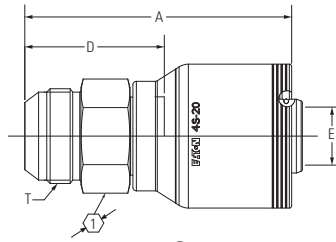

4S

Part Number	Terminal End	Hose Size		Thread	A		D		E Ø		in
		DN	Dash size		in	mm	in	mm	in	mm	
4SA6MJ6 (06-506)	-6	10	-6	9/16-18	53,7	2.12	31,0	1.22	6,7	0.26	11/16
4SA8MJ6 (06-508)	-8	10	-6	3/4-16	49,4	1.94	28,1	1.11	6,7	0.26	13/16
4SA8MJ8 (08-508)	-8	12	-8	3/4-16	65,8	2.59	35,5	1.40	9,6	0.38	13/16
4SA10MJ8 (08-510)	-10	12	-8	7/8-14	59,1	2.33	31,9	1.26	9,6	0.38	15/16
4SA12MJ8	-12	12	-8	1 1/16-12	63,4	2.50	36,2	1.43	9,6	0.38	1 1/8
4SA10MJ10 (10-510)	-10	16	-10	7/8-14	69,4	2.73	40,5	1.59	12,3	0.48	15/16
4SA12MJ10 (10-512)	-12	16	-10	1 1/16-12	62,4	2.46	36,4	1.43	12,8	0.50	1 1/8
4SA10MJ12 (12-510)	-10	19	-12	7/8-14	84,3	3.32	48,2	1.90	12,3	0.48	15/16
4SA12MJ12 (12-512)	-12	19	-12	1 1/16-12	86,9	3.42	50,8	2.00	14,2	0.56	1 1/8
4SA14MJ12 (12-514)	-14	19	-12	1 3/16-12	83,1	3.27	47,0	1.85	14,2	0.56	1 1/4
4SA16MJ12 (12-516)	-16	19	-12	1 5/16-12	83,6	3.29	47,5	1.87	14,2	0.56	1 3/8
4SA16MJ16 (16-516)	-16	25	-16	1 5/16-12	93,7	3.69	54,0	2.13	19,2	0.75	1 3/8
4SA20MJ16 (16-520)	-20	25	-16	1 5/8-12	99,6	3.92	60,0	2.36	19,2	0.76	1 11/16
4SA20MJ20 (20-520)	-20	31	-20	1 5/8-12	115,7	4.56	60,5	2.38	25,2	0.99	1 11/16
4SA24MJ24 (24-524)	-24	38	-24	1 7/8-12	151,3	5.96	73,3	2.89	31,1	1.22	2
4SA32MJ32 (32-532)	-32	51	-32	2 1/2-12	163,8	6.45	85,8	3.38	42,1	1.66	2 5/8

⚠ Refer to note below.

⚠ When assembled with all Eaton components, all SAE 37° JIC male and female terminal ends in the 4S & 6S product line are rated at the pressures listed and have passed one million impulse cycles at 133% of this pressure. All straight configurations achieve a 4:1 burst. The 45° and 90° elbow configurations in the -12 size meet a 3.2:1 burst the 45° and 90° elbow configurations in the -16 size achieve a 2.8:1 burst; the 45° and 90° elbow configurations in the -20 size meet a 4:1 burst and the 45° & 90° elbow configurations in the -24 size meet a 2.4:1 burst.

4S Fittings

For use with hoses:

H430-6,-8,-10,-12,-16,-20,-24,-32;
H430R-6,-8,-10,-12,-16,-20,-24,-32;
H464-12,-16,-20,-24,-32;
H471-12,-16,-20,-24; EC600-12,-16;
EC525-12,-16,-20,-24,-32; EC810-12,-16

6S Fittings

For use with hoses:

H471-32;
EC600-20;
EC810-20,-24,-32

Crimp fittings

Spiral hose fittings
(4S/6S Series)

Female JIC/37° Swivel (FJ)

Straight

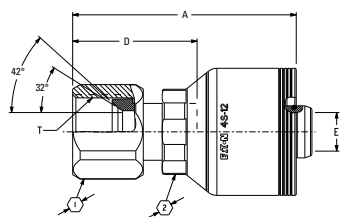

4S

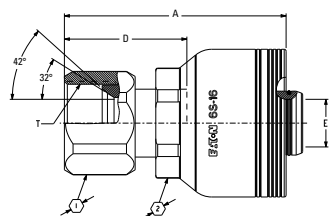

6S

⚠ Refer to note below.

⚠ When assembled with all Eaton components, all SAE 37° JIC male and female terminal ends in the 4S & 6S product line are rated at the pressures listed and have passed one million impulse cycles at 133% of this pressure. All straight configurations achieve a 4:1 burst. The 45° and 90° elbow configurations in the -12 size meet a 3.2:1 burst the 45° and 90° elbow configurations in the -16 size achieve a 2.8:1 burst; the 45° and 90° elbow configurations in the -20 size meet a 4:1 burst and the 45° & 90° elbow configurations in the -24 size meet a 2.4:1 burst.

Part Number	Terminal End		Hose Size		Thread		A		D		E Ø		①		②	
	Dash size	DN	Dash size	in	mm	in	mm	in	mm	in	mm	in	mm	in	in	
4SA4FJ6 (06-604)	-4	10	-6	7/16-20	51,6	2.03	30,3	1.19	4,4	0.17	14,3	9/16	11/16			
4SA6FJ6 (06-606)	-6	10	-6	9/16-18	53,0	2.09	32,2	1.27	6,7	0.26	17,5	11/16	11/16			
4SA8FJ6 (06-608)	-8	10	-6	3/4-16	54,8	2.16	34,0	1.34	6,7	0.26	22,2	7/8	11/16			
4SA6FJ8 (08-606)	-6	12	-8	9/16-18	68,3	2.69	38,0	1.50	9,6	0.38	17,5	11/16	11/16			
4SA8FJ8 (08-608)	-8	12	-8	3/4-16	64,8	2.55	36,7	1.44	9,6	0.38	22,2	7/8	7/8			
4SA10FJ8 (08-610)	-10	12	-8	7/8-14	67,3	2.65	39,2	1.54	9,6	0.38	25,4	1	7/8			
4SA12FJ8 (08-612)	-12	12	-8	1 1/16-12	68,5	2.70	40,4	1.59	9,6	0.38	31,8	1 1/4	7/8			
4SA10FJ10 (10-610)	-10	16	-10	7/8-14	66,1	2.60	40,6	1.60	12,8	0.50	25,4	1	1 1/16			
4SA12FJ10 (10-612)	-12	16	-10	1 1/16-12	67,1	2.64	41,5	1.63	12,8	0.50	31,8	1 1/4	1 1/16			
4SA10FJ12 (12-610)	-10	19	-12	7/8-14	75,0	2.95	38,8	1.53	12,3	0.48	30,0	1 3/16	1			
4SA12FJ12 (12-612)	-12	19	-12	1 1/16-12	82,0	3.23	45,7	1.80	14,2	0.56	30,0	1 3/16	1 1/4			
4SA14FJ12 (12-614)	-14	19	-12	1 3/16-12	77,5	3.05	41,3	1.63	14,2	0.56	30,0	1 3/16	1 3/8			
4SA16FJ12 (12-616)	-16	19	-12	1 5/16-12	80,2	3.16	44,0	1.73	14,2	0.56	30,0	1 3/16	1 1/2			
4SA12FJ16 (16-612)	-12	25	-16	1 1/16-12	78,8	3.10	39,1	1.54	15,5	0.61	41,0	1 5/8	1 1/4			
4SA16FJ16 (16-616)	-16	25	-16	1 5/16-12	89,2	3.51	49,3	1.94	19,2	0.76	41,0	1 5/8	1 1/2			
4SA20FJ16 (16-620)	-20	25	-16	1 5/8-12	85,8	3.38	46,0	1.81	19,2	0.76	41,0	1 5/8	2			
4SA16FJ20 (20-616)	-16	31	-20	1 5/16-12	99,1	3.90	43,7	1.72	25,2	0.99	46,0	1 13/16	1 1/2			
4SA20FJ20 (20-620)	-20	31	-20	1 5/8-12	101,6	4.00	46,3	1.82	25,2	0.99	46,0	1 13/16	2			
4SA24FJ20 (20-624)	-24	31	-20	1 7/8-12	106,8	4.20	51,5	2.03	25,2	0.99	46,0	1 13/16	2 1/4			
4SA24FJ24 (24-624)	-24	38	-24	1 7/8-12	134,9	5.31	56,8	2.24	31,1	1.22	57,0	2 1/4	2 1/4			
4SA32FJ32 (32-632)	-32	51	-32	2 1/2-12	146,0	5.75	68,0	2.68	42,1	1.66	73,0	2 7/8	2 7/8			
6S	Dash size	DN	Dash size	in	mm	in	mm	in	mm	in	mm	in	in			
6SA20FJ20 (20-620)	-20	31	-20	1 5/8-12	102,3	4.03	46,3	1.82	25,2	0.99	46,0	1 13/16	2			
6SA24FJ20 (20-624)	-24	31	-20	1 7/8-12	107,5	4.23	51,5	2.03	25,2	0.99	46,0	1 13/16	2 1/4			
6SA24FJ24 (23-624)	-24	38	-24	1 7/8-12	134,9	5.31	56,8	2.24	31,1	1.22	57,0	2 1/4	2 1/4			
6SA32FJ32 (32-632)	-32	51	-32	2 1/2-12	146,0	5.75	68,0	2.68	42,1	1.66	73,0	2 7/8	2 7/8			

Crimp fittings

Spiral hose fittings
(4S/6S Series)

4S Fittings

For use with hoses:

H430-6,-8,-10,-12,-16,-20,-24,-32;
H430R-6,-8,-10,-12,-16,-20,-24,-32;
H464-12,-16,-20,-24,-32;
H471-12,-16,-20,-24; EC600-12,-16;
EC525-12,-16,-20,-24,-32; EC810-12,-16

6S Fittings

For use with hoses:

H471-32;
EC600-20;
EC810-20,-24,-32

H

Female JIC/37° Swivel (FJA)

45° Elbow

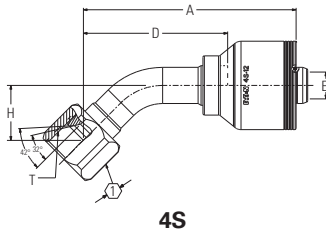

Part number	Terminal end		Hose size		Thread		A		D		E Ø		H		1
	Dash size	DN	Dash size	DN	in	mm	in	mm	in	mm	in	mm	in	in	
4SA6FJA6 (06-686)	-6	10	-6	10	9/16-18	56,5	2.22	33,3	1.31	6,2	0.24	9,9	0.39	11/16	
4SA8FJA6 (06-688)	-8	10	-6	10	3/4-16	75,6	2.98	54,3	2.14	6,7	0.26	24,2	0.95	7/8	
4SA8FJA8 (08-688)	-8	12	-8	12	3/4-16	72,9	2.87	42,7	1.68	9,4	0.37	14,0	0.55	7/8	
4SA10FJA8 (08-690)	-10	12	-8	12	7/8-14	82,5	3.25	55,3	2.18	9,4	0.37	25,3	1.00	1	
4SA10FJA10	-10	16	-10	16	7/8-14	71,6	2.82	45,4	1.79	11,7	0.46	16,0	0.63	1	
4SA12FJA10 (10-692)	-12	16	-10	16	1 1/16-12	92,6	3.65	66,5	2.62	12,8	0.50	29,4	1.16	1 1/4	
4SA12FJA12 (12-692)	-12	19	-12	19	1 1/16-12	112,3	4.42	76,1	3.00	14,2	0.56	29,0	1.14	1 1/4	
4SA16FJA12 (12-696)	-16	19	-12	19	1 5/16-12	133,6	5.26	97,5	3.84	14,2	0.56	38,0	1.50	1 1/2	
4SA16FJA16 (16-696)	-16	25	-16	25	1 5/16-12	128,8	5.07	89,3	3.52	19,2	0.76	38,0	1.50	1 1/2	
4SA20FJA16 (16-697)	-20	25	-16	25	1 5/8-12	120,1	4.73	80,4	3.17	19,2	0.75	32,0	1.26	2	
4SA20FJA20 (20-697)	-20	31	-20	31	1 5/8-12	135,6	5.34	80,4	3.17	25,2	0.99	32,0	1.26	2	
4SA24FJA24 (24-698)	-24	38	-24	38	1 7/8-12	212,0	8.35	134,0	5.28	31,1	1.22	43,0	1.69	2 1/4	
6S	Dash size	DN	Dash size	DN	in	mm	in	mm	in	mm	in	mm	in	in	
6SA20FJA20 (20-697)	-20	31	-20	31	1 5/8-12	136,4	5.37	80,4	3.17	25,2	0.99	32,0	1.26	2	
6SA24FJA24 (24-698)	-24	38	-24	38	1 7/8-12	212,0	8.35	134,0	5.28	31,1	1.22	43,0	1.69	2 1/4	

⚠ Refer to note below.

Female JIC/37° Swivel (FJG)

60° Elbow

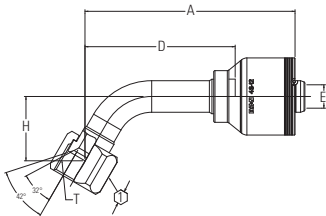

Part Number	Terminal End		Hose Size		Thread		A		D		E Ø		H		1
	Dash size	DN	Dash size	DN	in	mm	in	mm	in	mm	in	mm	in	in	
4SA12FJG12 (12-C62)	-12	19	-12	19	1 1/16-12	127,0	5.00	90,8	3.58	14,2	0.56	38,9	1.53	1 1/4	
4SA16FJG16 (16-C66)	-16	25	-16	25	1 5/16-12	144,4	5.69	104,8	4.12	19,2	0.76	47,6	1.87	1 1/2	

⚠ Refer to note below.

4S

⚠ When assembled with all Eaton components, all SAE 37° JIC male and female terminal ends in the 4S & 6S product line are rated at the pressures listed and have passed one million impulse cycles at 133% of this pressure. All straight configurations achieve a 4:1 burst. The 45° and 90° elbow configurations in the -12 size meet a 3.2:1 burst the 45° and 90° elbow configurations in the -16 size achieve a 2.8:1 burst; the 45° and 90° elbow configurations in the -20 size meet a 4:1 burst and the 45° & 90° elbow configurations in the -24 size meet a 2.4:1 burst.

4S Fittings

For use with hoses:

H430-6,-8,-10,-12,-16,-20,-24,-32;
H430R-6,-8,-10,-12,-16,-20,-24,-32;
H464-12,-16,-20,-24,-32;
H471-12,-16,-20,-24; EC600-12,-16;
EC525-12,-16,-20,-24,-32; EC810-12,-16

6S Fittings

For use with hoses:

H471-32;
EC600-20;
EC810-20,-24,-32

Crimp fittings

Spiral hose fittings
(4S/6S Series)

H

Female JIC/37° Swivel (FJB)

90° Elbow

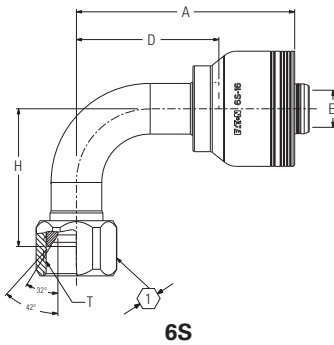
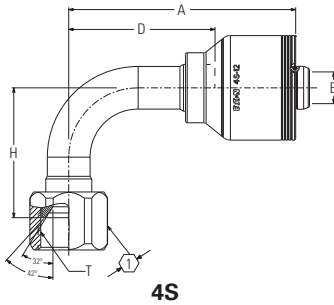

Part Number	Terminal End		Hose Size		Thread		A		D		E Ø		H		1
	Dash size	DN	Dash size	in	mm	in	mm	in	mm	in	mm	in	mm	in	
4SA6FJB6 (06-666)	-6	10	-6	9/16-18	54,1	2.13	30,9	1.22	6,2	0.24	21,6	0.85	11/16		
4SA8FJB6 (06-668)	-8	10	-6	3/4-16	64,7	2.55	43,4	1.71	6,7	0.26	47,4	1.87	7/8		
4SA8FJB8 (08-668)	-8	12	-8	3/4-16	67,1	2.64	36,7	1.44	9,4	0.37	27,7	1.09	7/8		
4SA8FJB8TZ	-8	12	-8	3/4-16	67,1	2.64	36,7	1.44	9,4	0.37	27,7	1.09	7/8		
4SA10FJB8 (08-670)	-10	12	-8	7/8-14	70,5	2.78	43,3	1.70	9,4	0.37	49,0	1.93	1		
4SA10FJB10 (10-670)	-10	16	-10	7/8-14	70,2	2.76	39,3	1.55	11,7	0.46	31,2	1.23	1		
4SA12FJB10 (10-672)	-12	16	-10	1 1/16-12	84,8	3.34	55,4	2.18	12,7	0.50	69,7	2.35	1 1/4		
4SA12FJB12 (12-672)	-12	19	-12	1 1/16-12	101,3	3.99	65,3	2.57	14,2	0.56	58,0	2.28	1 1/4		
4SA16FJB12 (12-676)	-16	19	-12	1 5/16-12	110,0	4.33	73,8	2.91	14,2	0.56	71,0	2.80	1 1/2		
4SA16FJB16 (16-676)	-16	25	-16	1 5/16-12	113,1	4.45	73,5	2.89	19,2	0.76	71,0	2.80	1 1/2		
4SA20FJB16 (16-677)	-20	25	-16	1 5/8-12	117,1	4.61	77,4	3.05	19,2	0.75	78,0	3.07	2		
4SA20FJB20 (20-677)	-20	31	-20	1 5/8-12	132,6	5.22	77,4	3.05	25,2	0.99	78,0	3.07	2		
4SA24FJB24 (24-678)	-24	38	-24	1 7/8-12	208,9	8.22	130,8	5.15	31,1	1.22	104,0	4.09	2 1/4		
6S	Dash size	DN	Dash size	in	mm	in	mm	in	mm	in	mm	in	mm	in	in
6SA20FJB20 (20-677)	-20	31	-20	1 5/8-12	133,4	5.25	77,4	3.05	25,2	0.99	78,0	3.07	2		
6SA24FJB24 (24-678)	-24	38	-24	1 7/8-12	208,9	8.22	130,8	5.15	31,1	1.22	104,0	4.09	2 1/4		

⚠ Refer to note below.

Female JIC/37° Swivel (FJC)

90° Elbow - Long Drop

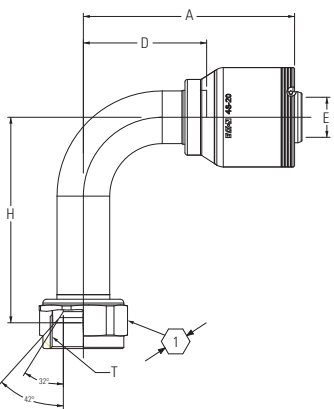

Part Number	Terminal End		Hose Size		Thread		A		D		E Ø		H		1
	Dash size	DN	Dash size	in	mm	in	mm	in	mm	in	mm	in	mm	in	
4SA6FJC6 (06-464)	-6	-10	-6	9/16-18	54,1	2.13	30,9	1.21	6,2	0.24	55,4	2.18	11/16		
4SA10FJC8 (08-650)	-10	-12	-8	7/8-14	70,5	2.78	43,3	1.70	9,4	0.37	86,2	3.39	1		
4SA12FJC12 (12-652)	-12	19	-12	1 1/16-12	101,3	3.99	65,3	2.57	14,2	0.56	96,0	3.78	1 1/4		
4SA16FJC16 (16-656L44)	-16	25	-16	1 5/16-12	112,5	4.43	73,5	2.89	19,0	0.75	114,0	4.49	1 1/2		
4SA20FJC20 (20-677L50)	-20	31	-20	1 5/8-12	132,6	5.22	77,4	3.05	25,2	0.99	129,0	5.08	2		

⚠ Refer to note.

⚠ When assembled with all Eaton components, all SAE 37° JIC male and female terminal ends in the 4S & 6S product line are rated at the pressures listed and have passed one million impulse cycles at 133% of this pressure. All straight configurations achieve a 4:1 burst. The 45° and 90° elbow configurations in the -12 size meet a 3.2:1 burst the 45° and 90° elbow configurations in the -16 size achieve a 2.8:1 burst; the 45° and 90° elbow configurations in the -20 size meet a 4:1 burst and the 45° & 90° elbow configurations in the -24 size meet a 2.4:1 burst.

Crimp fittings

Spiral hose fittings
(4S/6S Series)

4S Fittings

For use with hoses:

H430-6,-8,-10,-12,-16,-20,-24,-32;
H430R-6,-8,-10,-12,-16,-20,-24,-32;
H464-12,-16,-20,-24,-32;
H471-12,-16,-20,-24; EC600-12,-16;
EC525-12,-16,-20,-24,-32; EC810-12,-16

6S Fittings

For use with hoses:

H471-32;
EC600-20;
EC810-20,-24,-32

H

Male O-ring Boss - Rigid (MB)

Straight

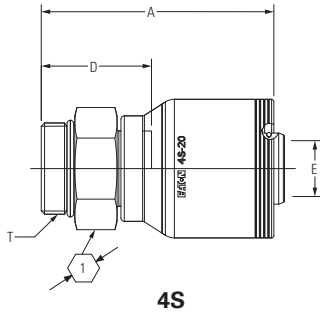

Part Number	Terminal End	Hose Size		Thread	A		D		E Ø		1
		DN	Dash size		in	mm	in	mm	in	mm	
4SA6MB6 (06-P06)	-6	10	-6	9/16-18	46,7	1.84	25,4	1.00	6,7	0.26	11/16
4SA8MB6 (06-P08)	-8	10	-6	3/4-16	46,1	1.81	24,8	0.98	6,7	0.26	7/8
4SA8MB8	-8	12	-8	3/4-16	57,4	2.26	30,1	1.19	9,6	0.38	7/8
4SA10MB8	-10	12	-8	7/8-14	54,8	2.16	27,6	1.09	9,6	0.38	1
4SA10MB10 (10-P10)	-10	16	-10	7/8-14	59,5	2.34	33,4	1.31	12,8	0.50	1
4SA12MB10 (10-P12)	-12	16	-10	1 1/16-12	57,3	2.26	31,2	1.23	12,8	0.50	1 1/4
4SA12MB12 (12-P12)	-12	19	-12	1 1/16-12	78,7	3.10	42,5	1.67	14,2	0.56	1 1/4
4SA16MB16 (16-P16)	-16	25	-16	1 5/16-12	88,1	3.47	48,5	1.91	19,2	0.76	1 1/2
4SA20MB20 (20-P20)	-20	31	-20	1 5/8-12	109,5	4.31	54,4	2.14	25,2	0.99	1 7/8
4SA24MB24 (24-P24)	-24	24	-24	1 7/8-12	134,1	5.28	56,0	2.21	31,1	1.22	2 1/8

Female SAE 45° Flare Swivel (FS)

Straight

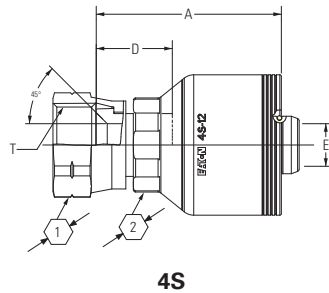

Part Number	Terminal End	Hose Size		Thread	A		D		E Ø		1	2
		DN	Dash size		in	mm	in	mm	in	mm		
4SA4FS6 (06-404)	-4	10	-6	7/16-20	51,6	2.03	30,3	1.19	4,9	0.19	9/16	11/16
4SA6FS6 (06-406)	-6	10	-6	5/8-18	54,7	2.15	33,4	1.31	6,7	0.26	3/4	11/16
4SA10FS8	-10	12	-8	7/8-14	64,6	2.54	37,4	1.47	9,6	0.38	1	13/16
4SA12FS12 (12-412)	-12	19	-12	1 1/16-14	61,5	2.42	25,4	1.00	14,2	0.56	1 1/4	1 3/16

Male ORS - Rigid (MR)

Straight

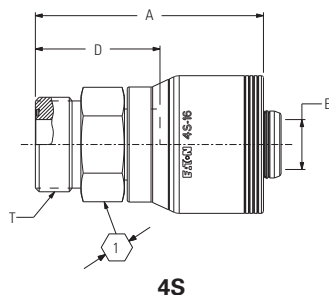

Part Number	Terminal End	Hose Size		Thread	A		D		E Ø		1
		DN	Dash size		in	mm	in	mm	in	mm	
4SA6MR6 (06-E66)	-6	10	-6	11/16-16	52,1	2.05	29,3	1.16	6,7	0.26	3/4
4SA8MR6 (06-E68)	-8	10	-6	13/16-16	45,5	1.79	24,2	0.95	6,7	0.26	7/8
4SA8MR8 (08-E68)	-8	12	-8	13/16-16	64,4	2.54	33,9	1.34	9,6	0.38	7/8
4SA12MR12 (12-E72)	-12	19	-12	1 3/16-12	80,8	3.18	44,4	1.75	14,2	0.56	1 1/4
4SA16MR12 (12-E76)	-16	19	-12	1 7/16-12	78,2	3.08	41,9	1.65	14,2	0.56	1 1/2
4SA16MR16 (16-E76)	-16	25	-16	1 7/16-12	87,7	3.45	47,9	1.89	19,2	0.76	1 1/2
4SA20MR16 (16-E80)	-20	25	-16	1 11/16-12	81,1	3.19	41,5	1.63	19,2	0.76	1 3/4
4SA20MR20 (20-E80)	-20	31	-20	1 11/16-12	107,1	4.22	52,0	2.05	25,2	0.99	1 3/4

4S Fittings

For use with hoses:

H430-6,-8,-10,-12,-16,-20,-24,-32;
 H430R-6,-8,-10,-12,-16,-20,-24,-32;
 H464-12,-16,-20,-24,-32;
 H471-12,-16,-20,-24; EC600-12,-16;
 EC525-12,-16,-20,-24,-32; EC810-12,-16

6S Fittings

For use with hoses:

H471-32;
 EC600-20;
 EC810-20,-24,-32

Crimp fittings

Spiral hose fittings
 (4S/6S Series)

Female ORS Swivel (FR)

Straight

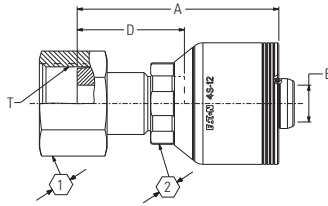

4S

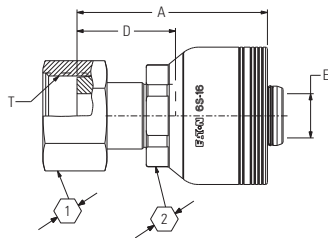

6S

Part Number	Terminal End		Hose Size		Thread		A		D		E Ø		1		2	
	Dash size	DN	Dash size	in	mm	in	mm	in	mm	in	mm	in	mm	in	in	
4SA6FR6 (06-S66)	-6	10	-6	11/16-16	52,7	2.07	31,4	1.24	6,7	0.26	30,0	13/16	11/16			
4SA8FR6 (06-S68)	-8	10	-6	13/16-16	54,4	2.14	33,6	1.32	6,7	0.26	23,8	15/16	11/16			
4SA6FR8	-6	12	-8	11/16-16	61,3	2.41	34,1	1.34	6,7	0.26	30,0	13/16	7/8			
4SA8FR8 (08-S68)	-8	12	-8	13/16-16	66,2	2.61	38,1	1.50	9,1	0.36	23,8	15/16	7/8			
4SA10FR8 (08-S70)	-10	12	-8	1-14	65,4	2.57	37,3	1.47	9,6	0.38	28,6	1 1/8	7/8			
4S8FR10	-8	16	-10	13/16-16	64,4	2.54	38,3	1.51	9,1	0.36	23,8	15/16	15/16			
4S10FR10	-10	16	-10	1-14	66,5	2.62	40,8	1.61	11,5	0.45	30,0	1 3/16	1 1/16			
4SA10FR10 (10-S70)	-10	16	-10	1-14	66,5	2.62	40,8	1.61	11,5	0.45	28,6	1 1/8	1 1/16			
4SA12FR10 (10-S72)	-12	16	-10	13/16-12	67,2	2.65	41,4	1.63	12,8	0.50	34,9	1 3/8	1			
4S12FR10	-12	16	-10	13/16-12	67,6	2.66	41,5	1.63	12,8	0.50	30,0	1 3/16	1.42			
4SA10FR12 (12-S70)	-10	19	-12	1-14	74,4	2.93	38,1	1.50	14,2	0.56	30,0	1 3/16	1 1/8			
4SA12FR12 (12-S72)	-12	19	-12	13/16-12	77,4	3.05	41,2	1.62	14,2	0.56	30,0	1 3/16	1 3/8			
4SA16FR12 (12-S76)	-16	19	-12	17/16-12	79,2	3.12	43,1	1.70	14,2	0.56	30,0	1 3/16	1 5/8			
4SA12FR16 (16-S72)	-12	25	-16	13/16-12	80,5	3.17	40,8	1.61	19,2	0.76	41,0	1 5/8	1 3/8			
4SA16FR16 (16-S76)	-16	25	-16	17/16-12	82,4	3.24	42,6	1.68	19,2	0.76	41,0	1 5/8	1 5/8			
4SA20FR16 (16-S80)	-20	25	-16	1 11/16-12	82,4	3.24	42,7	1.68	19,2	0.76	41,0	1 5/8	1 7/8			
4SA20FR20 (20-S80)	-20	31	-20	1 11/16-12	99,0	3.90	43,8	1.72	25,2	0.99	46,0	1 13/16	1 7/8			
4SA24FR24 (24-S84)	-24	38	-24	2-12	125,7	4.95	47,6	1.87	31,1	1.22	57,0	2 1/4	2 1/4			
6S	Dash size	DN	Dash size	in	mm	in	mm	in	mm	in	mm	in	mm	in	in	
6SA20FR20 (20-S80)	-20	31	-20	1 11/16-12	99,8	3.93	43,8	1.72	25,2	0.99	46,0	1 13/16	1 7/8			
6SA24FR24 (24-S84)	-24	38	-24	2-12	125,7	4.95	47,6	1.87	31,1	1.22	57,0	2 1/4	2 1/4			

Crimp fittings

Spiral hose fittings
(4S/6S Series)

4S Fittings

For use with hoses:

H430-6,-8,-10,-12,-16,-20,-24,-32;
H430R-6,-8,-10,-12,-16,-20,-24,-32;
H464-12,-16,-20,-24,-32;
H471-12,-16,-20,-24; EC600-12,-16;
EC525-12,-16,-20,-24,-32; EC810-12,-16

6S Fittings

For use with hoses:

H471-32;
EC600-20;
EC810-20,-24,-32

Female ORS Swivel (FRA)

45° Elbow

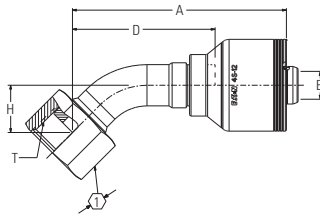

4S

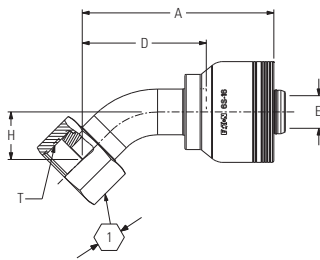

6S

Part Number	Terminal End		Hose Size		Thread		A		D		E Ø		H		1
	Dash size	DN	Dash size	in	mm	in	mm	in	mm	in	mm	in	mm	in	
4SA4FRA6	-4	10	-6	9/16-18	54,4	2.14	33,1	1.30	4,2	0.17	10,4	0.41	11/16		
4SA6FRA6 (06-L66)	-6	10	-6	11/16-16	59,9	2.36	36,3	1.43	6,2	0.24	10,9	0.43	13/16		
4SA8FRA6 (06-L68)	-8	10	-6	13/16-16	65,6	2.58	44,3	1.74	6,7	0.26	15,0	0.59	15/16		
4S8FRA8	-8	12	-8	13/16-16	72,7	2.86	45,5	1.79	9,1	0.36	15,0	0.59	15/16		
4SA8FRA8 (08-L68)	-8	12	-8	13/16-16	76,1	3.00	45,5	1.79	8,5	0.33	15,0	0.59	15/16		
4SA8FRA8.022	-8	12	-8	13/16-16	79,3	3.12	52,1	2.05	9,1	0.36	22,1	0.87	15/16		
4SA10FRA8 (08-L70)	-10	12	-8	1-14	78,3	3.08	51,1	2.01	9,6	0.38	16,5	0.65	1 1/8		
4SA10FRA10 (10-L70)	-10	16	-10	1-14	80,9	3.18	51,3	2.02	11,0	0.44	16,5	0.65	1 1/8		
4SA12FRA10	-12	16	-10	1 3/16-12	86,1	3.39	60,0	2.36	12,8	0.50	21,1	0.83	1 3/8		
4SA12FRA12 (12-L72)	-12	19	-12	1 3/16-12	108,7	4.28	72,5	2.85	14,2	0.56	24,0	0.94	1 3/8		
4SA16FRA12 (12-L76)	-16	19	-12	1 7/16-12	119,9	4.72	83,7	3.30	14,2	0.56	28,0	1.10	1 5/8		
4SA16FRA16 (16-L76)	-16	25	-16	1 7/16-12	112,8	4.44	73,0	2.87	19,2	0.76	28,0	1.10	1 5/8		
4SA20FRA16 (16-L80)	-20	25	-16	1 11/16-12	136,7	5.38	97,0	3.82	19,2	0.76	31,0	1.22	1 7/8		
4SA20FRA20 (20-L80)	-20	31	-20	1 11/16-12	153,4	6.04	98,1	3.86	25,2	0.99	31,0	1.22	1 7/8		
4SA24FRA24 (24-L84)	-24	38	-24	2-12	212,0	8.35	134,0	5.28	31,1	1.22	43,0	1.69	2 1/4		
6S	Dash size	DN	Dash size	in	mm	in	mm	in	mm	in	mm	in	in		
6SA20FRA20 (20-180)	-20	31	-20	1 11/16-12	154,1	6.07	98,1	3.86	25,2	0.99	31,0	1.22	1 7/8		
6SA24FRA24 (24-L84)	-24	38	-24	2-12	212,0	8.35	134,0	5.28	31,1	1.22	43,0	1.69	2 1/4		

4S Fittings

For use with hoses:

H430-6,-8,-10,-12,-16,-20,-24,-32;
 H430R-6,-8,-10,-12,-16,-20,-24,-32;
 H464-12,-16,-20,-24,-32;
 H471-12,-16,-20,-24; EC600-12,-16;
 EC525-12,-16,-20,-24,-32; EC810-12,-16

6S Fittings

For use with hoses:

H471-32;
 EC600-20;
 EC810-20,-24,-32

Crimp fittings

Spiral hose fittings
 (4S/6S Series)

Female ORS Swivel (FRB)

90° Elbow

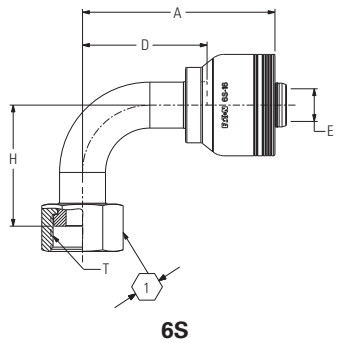
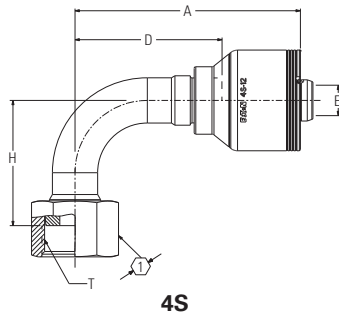

Part Number	Terminal end		Hose size		Thread		A		D		E Ø		H		1	
	Dash size	DN	Dash size	in	mm	in	mm	in	mm	in	mm	in	mm	in	mm	in
4SA6FRB6	-6	10	-6	11/16-16	57,6	2.27	34,1	1.34	6,2	0.24	22,9	0.9	20,6	13/16		
4SA6FRB6.038	-6	10	-6	11/16-16	55,4	2.18	34,1	1.34	6,4	0.25	38,4	1.51	20,6	13/16		
4SA8FRB6	-8	10	-6	13/16-16	62,5	2.46	41,2	1.62	6,7	0.26	29,2	1.15	23,8	15/16		
4SA6FRB8	-6	12	-8	11/16-16	62,4	2.46	35,2	1.39	6,4	0.25	22,9	0.9	20,6	13/16		
4SA8FRB8	-8	12	-8	13/16-16	73,0	2.87	42,4	1.67	8,5	0.33	29,2	1.15	23,8	15/16		
4SA10FRB8	-10	12	-8	1-14	75,6	2.98	48,4	1.91	9,6	0.38	32,3	1.27	28,6	1 1/8		
4SA12FRB8	-12	12	-8	1 3/16-12	83,3	3.28	56,1	2.21	9,6	0.38	47,8	1.88	34,9	1 3/8		
4S10FRB10	-10	16	-10	1-14	74,7	2.94	48,6	1.91	11,5	0.45	32,3	1.27	30,0	1 3/16		
4SA10FRB10	-10	16	-10	1-14	78,3	3.08	43,6	1.91	11,0	0.44	32,3	1.27	28,6	1 1/8		
4S10FRB10.047	-10	16	-10	1-14	74,7	2.94	48,6	1.91	11,5	0.45	47,0	1.85	30,0	1 3/16		
4SA10FRB10.047	-10	16	-10	1-14	74,7	2.94	48,6	1.91	11,5	0.45	47,0	1.85	28,6	1 1/8		
4S12FRB10	-12	16	-10	1 3/16-12	84,2	3.31	58,1	2.29	12,0	0.47	47,8	1.88	36,0	1.42		
4SA12FRB10	-12	16	-10	1 3/16-12	84,2	3.31	58,1	2.29	12,0	0.47	47,8	1.88	34,9	1 3/8		
4S12FRB10.058	-12	16	-10	1 3/16-12	82,9	3.26	56,8	2.24	12,0	0.47	57,9	2.28	36,0	1.42		
4SA10FRB12	-10	19	-12	1-14	91,5	3.6	55,3	2.18	14,2	0.56	32,3	1.27	28,6	1 1/8		
4SA12FRB12	-12	19	-12	1 3/16-12	104,4	4.11	68,1	2.68	14,2	0.56	58,0	2.28	34,9	1 3/8		
4SA16FRB12	-16	19	-12	1 7/16-12	117,1	4.61	80,9	3.19	14,2	0.56	71,0	2.8	41,3	1 5/8		
4SA12FRB16	-12	25	-16	1 3/16-12	107,5	4.23	67,7	2.67	19,2	0.76	58,0	2.28	34,9	1 3/8		
4SA16FRB16	-16	25	-16	1 7/16-12	112,8	4.44	73,0	2.87	19,2	0.76	71,0	2.8	41,3	1 5/8		
4SA20FRB16	-20	25	-16	1 11/16-16	136,5	5.37	96,8	3.81	19,2	0.76	78,0	3.07	47,6	1 7/8		
4SA20FRB20	-20	31	-20	1 11/16-16	153,1	6.03	97,9	3.85	25,2	0.99	78,0	3.07	47,6	1 7/8		
4SA24FRB20	-24	31	-20	2-12	152,9	6.02	97,9	3.85	25,2	0.99	86,0	3.39	57,2	2 1/4		
4SA24FRB24	-24	38	-24	2-12	208,9	8.22	130,8	5.15	31,1	1.22	104,0	4.09	57,2	2 1/4		
6S	Dash size	DN	Dash size	in	mm	in	mm	in	mm	in	mm	in	mm	in	mm	in
6SA20FRB20	-20	31	-20	1 11/16-16	153,9	6.06	97,9	3.85	25,2	0.99	78,0	3.07	47,6	1 7/8		
6SA24FRB2	-24	38	-24	2-12	208,9	8.22	130,8	5.15	31,1	1.22	104,0	4.09	57,2	2 1/4		

Crimp fittings

Spiral hose fittings
(4S/6S Series)

4S Fittings

For use with hoses:

H430-6,-8,-10,-12,-16,-20,-24,-32;
H430R-6,-8,-10,-12,-16,-20,-24,-32;
H464-12,-16,-20,-24,-32;
H471-12,-16,-20,-24; EC600-12,-16;
EC525-12,-16,-20,-24,-32; EC810-12,-16

6S Fittings

For use with hoses:

H471-32;
EC600-20;
EC810-20,-24,-32

H

Female ORS Swivel (FRC)

90° Elbow - Long Drop

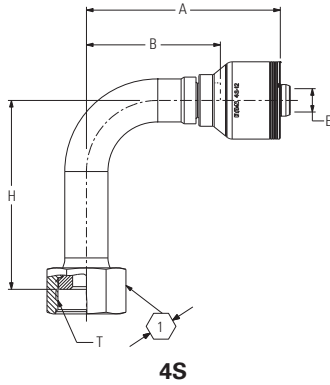

Part Number	Terminal End		Hose Size		Thread		A		D		E Ø		H		1
	Dash size		DN	Dash size	in		mm	in	mm	in	mm	in	mm	in	
4SA6FRC6 (06-A66)	-6		10	-6	11/16-16		57,6	2.27	34,1	1.34	6,2	0.24	54,1	2.13	13/16
4SA8FRC6 (06-A68)	-8		10	-6	13/16-16		64,7	2.55	43,4	1.71	6,7	0.26	64,8	2.55	15/16
4S8FRC8	-8		12	-8	13/16-16		69,6	2.74	42,4	1.67	8,8	0.35	63,8	2.51	15/16
4SA8FRC8 (08-A68)	-8		12	-8	13/16-16		73,0	2.87	42,4	1.67	8,5	0.33	63,8	2.51	15/16
4SA10FRC8 (08-A70)	-10		12	-8	1-14		75,6	2.98	48,4	1.91	9,6	0.38	70,1	2.76	1 1/8
4SA10FRC10	-10		16	-10	1-14		78,3	3.08	48,6	1.91	11,0	0.44	70,1	2.76	1 1/8
4S12FRC10	-12		16	-10	1 3/16-12		84,2	3.31	58,1	2.29	12,0	0.47	96,0	3.78	1.42
4SA10FRC12 (12-A70)	-10		19	-12	1-14		91,5	3.60	55,3	2.18	14,2	0.56	70,0	2.76	1 1/8
4SA12FRC12 (12-A72)	-12		19	-12	1 3/16-12		104,4	4.11	68,1	2.68	14,2	0.56	96,0	3.78	1 3/8
4SA16FRC12 (12-A76)	-16		19	-12	1 7/16-12		117,1	4.61	80,9	3.19	14,2	0.56	114,0	4.49	1 5/8
4SA16FRC16 (16-A76)	-16		25	-16	1 7/16-12		112,8	4.44	73,0	2.87	19,2	0.76	114,0	4.49	1 5/8
4SA20FRC20 (20-A80)	-20		31	-20	1 11/16-12		152,9	6.02	97,9	3.85	25,2	0.99	129,0	5.08	1 7/8
4SA24FRC20 (20-A84)	-24		31	-20	2-12		152,9	6.02	97,9	3.85	25,2	0.99	141,0	5.55	2 1/4
4SA24FRC24 (24-A84L55)	-24		38	-24	2-12		152,9	6.02	97,9	3.85	25,2	0.99	141,0	5.55	2 1/4

4S Fittings

For use with hoses:

H430-6,-8,-10,-12,-16,-20,-24,-32;
 H430R-6,-8,-10,-12,-16,-20,-24,-32;
 H464-12,-16,-20,-24,-32;
 H471-12,-16,-20,-24; EC600-12,-16;
 EC525-12,-16,-20,-24,-32; EC810-12,-16

6S Fittings

For use with hoses:

H471-32;
 EC600-20;
 EC810-20,-24,-32

Crimp fittings

Spiral hose fittings
 (4S/6S Series)

H

SAE Code 61 Flange (FL)

Straight

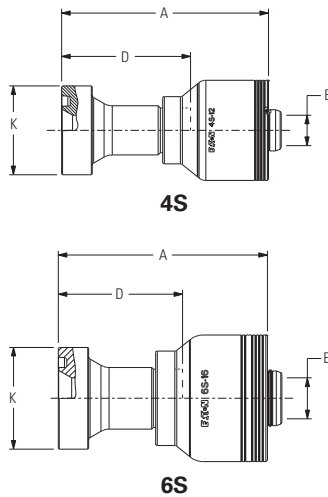

Part Number	Terminal End	Hose Size		Flange Head Dia. K Ø		A		D		E Ø	
	Dash size	DN	Dash size	mm	in	mm	in	mm	in	mm	in
4S8FL8 (08-G08)	-8	12	-8	30,2	1.19	79,5	3.13	52,3	2.06	9,6	0.38
4S12FL8 (08-G12)	-12	12	-8	38,1	1.50	80,6	3.17	53,3	2.10	9,6	0.38
4S12FL10 (10-G12)	-12	16	-10	38,1	1.50	79,4	3.13	53,3	2.10	12,8	0.50
4S12FL12 (12-G12)	-12	19	-12	38,1	1.50	90,7	3.57	54,5	2.15	14,2	0.56
4S16FL12 (12-G16)	-16	19	-12	44,5	1.75	90,2	3.55	54,0	2.13	14,2	0.56
4S20FL12 (12-G20)	-20	19	-12	50,8	2.00	97,7	3.85	61,5	2.42	14,2	0.56
4S16FL16 (16-G16)	-16	25	-16	44,5	1.75	93,3	3.67	53,6	2.11	19,2	0.76
4S20FL16 (16-G20)	-20	25	-16	50,8	2.00	100,8	3.97	61,1	2.41	19,2	0.76
4S24FL16 (16-G24)	-24	25	-16	60,4	2.38	97,4	3.83	57,7	2.27	19,2	0.76
4S16FL20 (20-G16)	-16	31	-20	44,5	1.75	110,5	4.35	55,5	2.18	25,2	0.99
4S20FL20 (20-G20)	-20	31	-20	50,8	2.00	117,4	4.62	62,2	2.45	25,2	0.99
4S24FL20 (20-G24)	-24	31	-20	60,4	2.38	106,7	4.20	51,6	2.03	25,2	0.99
4S32FL20 (20-G32)	-32	31	-20	71,4	2.81	104,9	4.13	49,9	1.96	25,2	0.99
4S24FL24 (24-G24)	-24	38	-24	60,4	2.38	171,6	6.75	93,6	3.68	31,1	1.22
4S32FL24 (24-G32)	-32	38	-24	71,4	2.81	174,7	6.88	96,7	3.81	31,1	1.22
4S32FL32 (32-G32)	-32	51	-32	71,4	2.81	177,5	6.99	99,5	3.92	42,1	1.66
6S	Dash size	DN	Dash size	mm	in	mm	in	mm	in	mm	in
6S20FL20 (20-G20)	-20	31	-20	50,8	2.00	118,2	4.65	62,2	2.45	25,2	0.99
6S24FL24 (24-G24)	-24	38	-24	60,4	2.38	171,6	6.75	93,6	3.68	31,1	1.22
6S32FL24 (24-G32)	-32	38	-24	71,4	2.81	174,7	6.88	96,7	3.81	31,1	1.22
6S32FL32 (32-G32)	-32	51	-32	71,4	2.81	177,5	6.99	99,5	3.92	42,1	1.66

Note: Reference page J-110 for
 Code 62 Split Flange Kits

Crimp fittings

Spiral hose fittings
(4S/6S Series)

4S Fittings

For use with hoses:

H430-6,-8,-10,-12,-16,-20,-24,-32;
H430R-6,-8,-10,-12,-16,-20,-24,-32;
H464-12,-16,-20,-24,-32;
H471-12,-16,-20,-24; EC600-12,-16;
EC525-12,-16,-20,-24,-32; EC810-12,-16

6S Fittings

For use with hoses:

H471-32;
EC600-20;
EC810-20,-24,-32

SAE Code 61 Flange (FLF)

30° Elbow

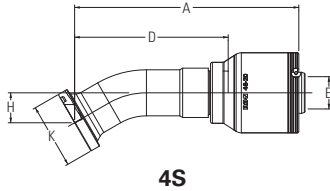

Part Number	Terminal End	Hose Size		Flange Head Dia. K Ø		A		D		E Ø		H	
	4S	Dash size	DN	Dash size	mm	in	mm	in	mm	in	mm	in	mm
4S8FLF8 (08-H21)	-8	12	-8	30,2	1.19	81,8	3.32	54,6	2.15	9,1	0.36	12,6	0.50
4S12FLF12 (12-H22)	-12	19	-12	38,1	1.50	119,4	4.70	83,3	3.28	14,2	0.56	16,4	0.65
4S16FLF12 (12-H23)	-16	19	-12	44,4	1.75	134,6	5.30	98,4	3.87	14,2	0.56	19,3	0.76
4S16FLF16 (16-H23)	-16	25	-16	44,4	1.75	137,7	5.42	97,9	3.85	19,2	0.76	19,3	0.76
4S20FLF16 (16-H24)	-20	25	-16	50,8	2.00	158,3	6.23	118,6	4.67	19,2	0.76	23,3	0.92
4S20FLF20 (20-H24)	-20	31	-20	50,8	2.00	174,7	6.88	119,7	4.71	25,2	0.99	23,3	0.92
4S24FLF20 (20-H25)	-24	31	-20	60,4	2.38	169,9	6.69	114,9	4.52	25,2	0.99	24,1	0.95
4S24FLF24 (24-H25)	-24	38	-24	60,3	2.37	223,4	8.80	145,4	5.72	31,1	1.22	26,8	1.06
4S32FLF32 (32-H26)	-32	51	-32	71,4	2.81	265,9	10.47	187,8	7.39	42,1	1.66	33,9	1.34

SAE Code 61 Flange (FLD)

22.5° Elbow

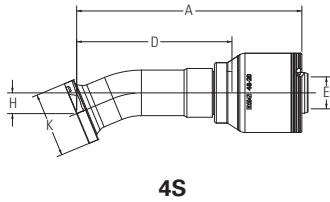

Part Number	Terminal End	Hose Size		Flange Head Dia. K Ø		A		D		E Ø		H	
	4S	Dash size	DN	Dash size	mm	in	mm	in	mm	in	mm	in	mm
4S8FLD8 (08-H01)	-8	12	-8	30,2	1.19	83,2	3.28	56,0	2.20	9,1	0.36	9,1	0.36
4S12FLD8 (08-H02)	-12	12	-8	38,1	1.50	98,4	3.87	71,2	2.80	9,4	0.37	11,1	0.44
4S12FLD12 (12-H02)	-12	19	-12	38,1	1.50	121,3	4.78	85,1	3.35	14,2	0.56	11,6	0.46
4S16FLD12 (12-H03)	-16	25	-12	44,4	1.75	136,7	5.38	100,5	3.96	14,2	0.56	13,5	0.53
4S16FLD16 (16-H03)	-16	25	-16	44,4	1.75	139,8	5.50	100,1	3.94	19,2	0.76	13,5	0.53
4S20FLD16 (16-H04)	-20	25	-16	50,8	2.00	160,9	6.33	121,2	4.77	19,2	0.76	16,3	0.64
4S20FLD20 (20-H04)	-20	31	-20	50,8	2.00	177,3	6.98	122,3	4.81	25,2	0.99	16,3	0.64
4S24FLD20 (20-H05)	-24	31	-20	60,4	2.38	173,6	6.83	117,6	4.63	25,2	0.99	17,1	0.67
4S24FLD24 (24-H05)	-24	38	-24	60,3	2.37	226,4	8.91	148,4	5.84	31,1	1.22	18,8	0.74
4S32FLD24 (24-H06)	-32	38	-24	71,4	2.81	266,7	10.50	188,7	7.43	31,1	1.22	23,5	0.93
4S32FLD32 (32-H06)	-32	51	-32	71,4	2.81	269,6	10.61	191,5	7.54	42,1	1.66	23,5	0.93

4S Fittings

For use with hoses:

H430-6,-8,-10,-12,-16,-20,-24,-32;
H430R-6,-8,-10,-12,-16,-20,-24,-32;
H464-12,-16,-20,-24,-32;
H471-12,-16,-20,-24; EC600-12,-16;
EC525-12,-16,-20,-24,-32; EC810-12,-16

6S Fittings

For use with hoses:

H471-32;
EC600-20;
EC810-20,-24,-32

Crimp fittings

Spiral hose fittings
(4S/6S Series)

H

SAE Code 61 Flange (FLA)

45° Elbow

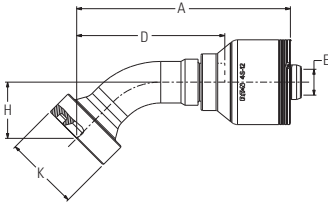

4S

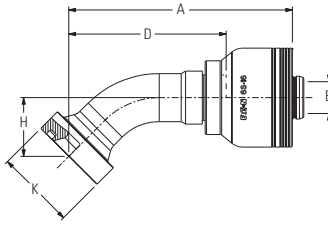

6S

Part number	Terminal end		Hose size		Flange Head Dia. K Ø		A		D		E Ø		H	
	Dash size	DN	Dash size	mm	in	mm	in	mm	in	mm	in	mm	in	
4S8FLA8 (08-G41)	-8	12	-8	30,2	1.19	77,5	3.05	50,3	1.98	9,1	0.36	19,8	0.78	
4S12FLA8 (08-G42)	-12	12	-8	38,1	1.50	90,6	3.57	63,4	2.50	9,6	0.38	25,4	1.00	
4S12FLA10 (10-G42)	-12	16	-10	38,1	1.50	90,3	3.56	64,2	2.53	12,8	0.50	25,4	1.00	
4S12FLA12 (12-G42)	-12	19	-12	38,1	1.50	113,8	4.48	77,6	3.06	14,2	0.56	27,0	1.06	
4S16FLA12 (12-G46)	-16	19	-12	44,4	1.75	127,9	5.04	91,7	3.61	14,2	0.56	32,0	1.26	
4S12FLA16 (16-G42)	-12	25	-16	38,1	1.50	116,9	4.60	77,2	3.04	19,2	0.76	27,0	1.06	
4S16FLA16 (16-G46)	-16	25	-16	44,4	1.75	131,0	5.16	91,3	3.59	19,2	0.76	32,0	1.26	
4S20FLA16 (16-G50)	-20	25	-16	50,8	2.00	150,2	5.91	110,5	4.35	19,2	0.76	39,0	1.54	
4S16FLA20 (20-G46)	-16	31	-20	44,4	1.75	152,1	5.99	97,0	3.82	25,2	0.99	32,0	1.26	
4S20FLA20 (20-G50)	-20	31	-20	50,8	2.00	166,8	6.57	111,6	4.39	25,2	0.99	39,0	1.54	
4S24FLA20 (20-G54)	-24	31	-20	60,4	2.38	161,6	6.36	106,6	4.20	25,2	0.99	39,5	1.56	
4S24FLA24 (24-G54)	-24	38	-24	60,3	2.37	214,3	8.44	136,3	5.37	31,1	1.22	45,0	1.77	
4S32FLA24 (24-G62)	-32	38	-24	71,4	2.81	251,0	9.88	173,0	6.81	31,1	1.22	57,5	2.26	
4S32FLA32 (32-G62)	-32	51	-32	71,4	2.81	253,9	10.00	175,9	6.92	42,1	1.66	57,5	2.26	
6S	Dash size	DN	Dash size	mm	in	mm	in	mm	in	mm	in	mm	in	
6S20FLA20 (20-G50)	-20	31	-20	50,8	2.00	167,6	6.60	111,6	4.39	25,2	0.99	39,0	1.54	
6S24FLA24 (24-G54)	-24	38	-24	60,3	2.37	214,3	8.44	136,3	5.37	31,1	1.22	45,0	1.77	
6S32FLA24 (24-G62)	-32	38	-24	71,4	2.81	251,0	9.88	173,0	6.81	31,1	1.22	57,5	2.26	
6S32FLA32 (32-G62)	-32	51	-32	71,4	2.81	253,9	10.00	175,9	6.92	42,1	1.66	57,5	2.26	

Crimp fittings

Spiral hose fittings
(4S/6S Series)

H

4S Fittings

For use with hoses:

H430-6,-8,-10,-12,-16,-20,-24,-32;
H430R-6,-8,-10,-12,-16,-20,-24,-32;
H464-12,-16,-20,-24,-32;
H471-12,-16,-20,-24; EC600-12,-16;
EC525-12,-16,-20,-24,-32; EC810-12,-16

6S Fittings

For use with hoses:

H471-32;
EC600-20;
EC810-20,-24,-32

SAE Code 61 Flange (FLG)

60° Elbow

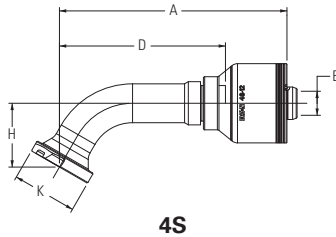

Part Number	Terminal End	Hose Size		Flange Head Dia. K Ø		A		D		E Ø		H	
		4S	Dash size	DN	Dash size	mm	in	mm	in	mm	in	mm	in
4S8FLG8 (08-H51)	-8	12	-8	30,2	1.19	88,1	3.47	60,9	2.40	9,1	0.36	28,8	1.13
4S12FLG8 (08-H52)	-12	12	-8	38,1	1.50	107,2	4.22	80,0	3.15	9,6	0.38	35,4	1.39
4S12FLG12 (12-H52)	-12	19	-12	38,1	1.50	133,9	5.27	97,7	3.85	14,2	0.56	37,6	1.48
4S16FLG12 (12-H53)	-16	19	-12	44,4	1.75	153,2	6.03	117,1	4.61	14,2	0.56	44,7	1.76
4S16FLG16 (16-H53)	-16	25	-16	44,4	1.75	156,4	6.16	116,6	4.59	19,2	0.76	44,7	1.76
4S20FLG16 (16-H54)	-20	25	-16	50,8	2.00	183,3	7.22	143,5	5.65	19,2	0.76	55,8	2.20
4S20FLG20 (20-H54)	-20	25	-20	50,8	2.00	199,7	7.86	144,7	5.70	25,2	0.99	55,8	2.20
4S24FLG20 (20-H56)	-24	31	-20	60,4	2.38	188,1	7.41	133,0	5.24	25,2	0.99	51,7	2.04
4S24FLG24 (24-H55)	-24	38	-24	60,3	2.37	253,3	9.97	175,3	6.90	31,1	1.22	65,2	2.57
4S32FLG32 (32-H56)	-32	51	-32	71,4	2.81	309,1	12.17	231,1	9.10	42,1	1.66	85,8	3.38

SAE Code 61 Flange (FLE)

67.5° Elbow

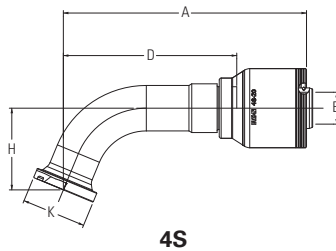

Part Number	Terminal End	Hose Size		Flange Head Dia. K Ø		A		D		E Ø		H	
		4S	Dash size	DN	Dash size	mm	in	mm	in	mm	in	mm	in
4S8FLE8 (08-H61)	-8	12	-8	30,2	1.19	84,1	3.31	56,9	2.24	9,1	0.36	32,3	1.27
4S12FLE8 (08-H62)	-12	12	-8	38,1	1.50	101,9	4.01	74,6	2.94	9,6	0.38	40,6	1.60
4S12FLE12 (12-H62)	-12	19	-12	38,1	1.50	128,6	5.06	92,4	3.64	14,2	0.56	43,2	1.70
4S16FLE12 (12-H63)	-16	19	-12	44,4	1.75	147,0	5.79	110,8	4.36	14,2	0.56	51,5	2.03
4S16FLE16 (16-H63)	-16	25	-16	44,4	1.75	150,1	5.91	110,3	4.34	19,2	0.76	51,5	2.03
4S20FLE16 (16-H64)	-20	25	-16	50,8	2.00	175,4	6.91	135,7	5.34	19,2	0.76	64,4	2.54
4S20FLE20 (20-H64)	-20	31	-20	50,8	2.00	191,8	7.55	136,8	5.39	25,2	0.99	64,4	2.54
4S24FLE20 (20-H65)	-24	31	-20	60,4	2.38	180,8	7.12	125,8	4.95	25,2	0.99	59,5	2.34
4S24FLE24 (24-H65)	-24	38	-24	60,3	2.37	244,2	9.61	166,2	6.54	31,1	1.22	75,2	2.96
4S32FLE24 (24-H66)	-32	38	-24	71,4	2.81	294,1	11.58	216,1	8.51	31,1	1.22	99,3	3.91
4S32FLE32 (32-H66)	-32	51	-32	71,4	2.81	297,0	11.69	219,0	8.62	42,1	1.66	99,3	3.91

4S Fittings

For use with hoses:

H430-6,-8,-10,-12,-16,-20,-24,-32;
 H430R-6,-8,-10,-12,-16,-20,-24,-32;
 H464-12,-16,-20,-24,-32;
 H471-12,-16,-20,-24; EC600-12,-16;
 EC525-12,-16,-20,-24,-32; EC810-12,-16

6S Fittings

For use with hoses:

H471-32;
 EC600-20;
 EC810-20,-24,-32

Crimp fittings

Spiral hose fittings
 (4S/6S Series)

H

SAE Code 61 Flange (FLB)

90° Elbow

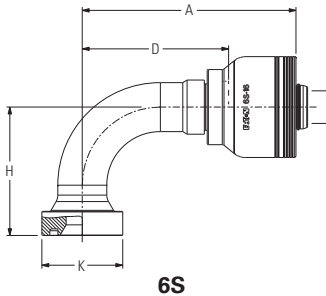
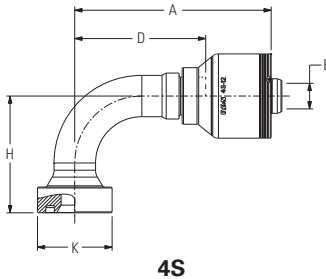

Part Number	Terminal End	Hose Size		Flange Head Dia. K Ø		A		D		E Ø		H	
		Dash size	DN	Dash size	mm	in	mm	in	mm	in	mm	in	mm
4S													
4S8FLB8 (08-G71)	-8	12	-8	30,2	1.19	69,5	2.74	42,3	1.67	9,1	0.36	41,4	1.63
4S12FLB8 (08-G72)	-12	12	-8	38,1	1.50	85,1	3.35	57,9	2.28	9,6	0.38	54,1	2.13
4S12FLB10 (10-G72)	-12	16	-10	38,1	1.50	84,2	3.31	58,1	2.29	12,8	0.50	54,1	2.13
4S12FLB12 (12-G72)	-12	19	-12	38,1	1.50	108,5	4.27	72,3	2.85	14,2	0.56	59,0	2.32
4S16FLB12 (12-G76)	-16	19	-12	44,4	1.75	122,8	4.84	86,6	3.41	14,2	0.56	71,0	2.80
4S20FLB12 (12-G80)	-20	19	-12	50,8	2.00	108,5	4.72	72,3	2.85	14,2	0.56	65,0	2.56
4S16FLB16 (16-G76)	-16	25	-16	44,4	1.75	126,0	4.96	86,2	3.39	19,2	0.76	71,0	2.80
4S16FLB16.116 (16-G76)	-16	25	-16	44,4	1.75	126,0	4.96	86,2	3.39	19,2	0.76	116,0	4.57
4S20FLB16 (16-G80)	-20	25	-16	50,8	2.00	145,2	5.72	105,4	4.15	19,2	0.76	89,0	3.50
4S24FLB16 (16-G84)	-24	25	-16	60,4	2.38	136,5	5.37	96,8	3.81	19,2	0.76	81,9	3.22
4S16FLB20 (20-G76)	-16	31	-20	44,4	1.75	147,1	5.79	91,9	3.62	25,2	0.99	71,0	2.80
4S20FLB20 (20-G80)	-20	31	-20	50,8	2.00	161,8	6.37	106,5	4.19	25,2	0.99	89,0	3.50
4S24FLB20 (20-G84)	-24	31	-20	60,4	2.38	152,9	6.02	97,9	3.85	25,2	0.99	81,9	3.22
4S24FLB24 (24-G84)	-24	38	-24	60,3	2.37	208,9	8.22	130,9	5.15	31,1	1.22	104,0	4.09
4S32FLB24 (24-G92)	-32	38	-24	71,4	2.81	247,4	9.74	169,4	6.67	31,1	1.22	138,0	5.43
4S32FLB32 (32-G92)	-32	51	-32	71,4	2.81	250,3	9.85	172,2	6.78	42,1	1.66	138,0	5.43
6S													
6S20FLB20 (20-G80)	-20	31	-20	50,8	2.00	162,5	6.40	106,5	4.19	25,2	0.99	89,0	3.50
6S24FLB24 (24-G84)	-24	38	-24	60,3	2.37	208,8	8.22	130,8	5.15	31,1	1.22	104,0	4.09
6S32FLB24 (24-G92)	-32	38	-24	71,4	2.81	247,4	9.74	169,4	6.67	31,1	1.22	138,0	5.43
6S32FLB32 (32-G92)	-32	51	-32	71,4	2.81	250,3	9.85	172,2	6.78	42,1	1.66	138,0	5.43

SAE Code 61 Flange (FLH)

110° Elbow

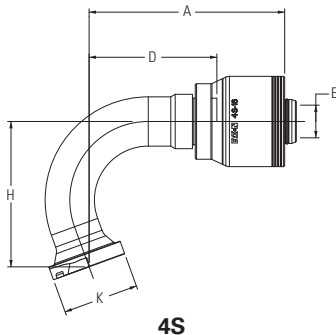

Part Number	Terminal End	Hose Size		Flange Head Dia. K Ø		A		D		E Ø		H	
		Dash size	DN	Dash size	mm	in	mm	in	mm	in	mm	in	mm
4S													
4S16FLH16 (16-H73)	-16	25	-16	44,4	1.75	114,6	4.51	74,9	2.95	19,2	0.76	85,2	3.35

Crimp fittings

Spiral hose fittings
(4S/6S Series)

4S Fittings

For use with hoses:

H430-6,-8,-10,-12,-16,-20,-24,-32;
H430R-6,-8,-10,-12,-16,-20,-24,-32;
H464-12,-16,-20,-24,-32;
H471-12,-16,-20,-24; EC600-12,-16;
EC525-12,-16,-20,-24,-32; EC810-12,-16

6S Fittings

For use with hoses:

H471-32;
EC600-20;
EC810-20,-24,-32

SAE Code 62 Flange (FH)

Straight

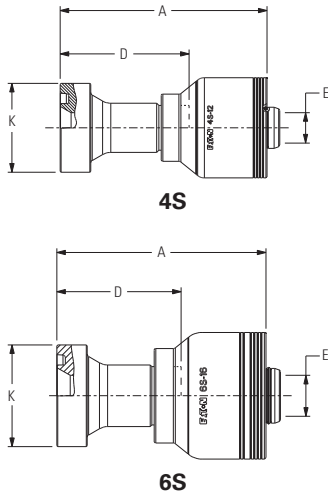

Note: Reference page J-110
for Code 62 Split Flange Kits

Part Number	Terminal End	Hose Size		Flange Head Dia. K Ø		A		D		E Ø	
	Dash size	DN	Dash size	mm	in	mm	in	mm	in	mm	in
4S8FH8 (08-D08)	-8	12	-8	31,8	1.25	79,5	3.13	52,3	2.06	9,6	0.38
4S12FH8 (08-D12)	-12	12	-8	41,3	1.63	80,6	3.17	53,3	2.10	9,6	0.38
4S12FH10 (10-D12)	-12	16	-10	41,3	1.63	79,6	3.13	53,5	2.11	12,8	0.50
4S12FH12 (12-D12)	-12	19	-12	41,3	1.63	90,7	3.57	54,5	2.15	14,2	0.56
4S16FH12 (12-D16)	-16	19	-12	47,7	1.88	90,2	3.55	54,0	2.13	14,2	0.56
4S12FH16 (16-D12)	-12	25	-16	41,3	1.63	96,3	3.79	56,7	2.23	14,2	0.56
4S16FH16 (16-D16)	-16	25	-16	47,7	1.88	98,9	3.89	59,1	2.33	19,2	0.76
4S20FH16 (16-D20)	-20	25	-16	54,0	2.13	100,8	3.97	61,0	2.40	19,2	0.76
4S16FH20 (20-D16)	-16	31	-20	47,7	1.88	123,8	4.87	68,6	2.70	25,2	0.99
4S20FH20 (20-D20)	-20	31	-20	54,0	2.13	123,3	4.85	68,1	2.68	25,2	0.99
4S24FH20 (20-D24)	-24	31	-20	63,5	2.50	129,0	5.08	73,9	2.91	25,2	0.99
4S24FH24 (24-D24)	-24	38	-24	63,5	2.50	189,6	7.46	111,6	4.39	31,1	1.22
4S32FH24 (24-D32)	-32	38	-24	79,4	3.13	204,4	8.05	126,4	4.89	31,1	1.22
4S32FH32 (32-D32)	-32	51	-32	79,4	3.13	202,7	7.98	124,7	4.91	42,1	1.66
6S	Dash size	DN	Dash size	mm	in	mm	in	mm	in	mm	in
6S20FH20 (20-D20)	-20	31	-20	54,0	2.13	124,0	4.88	68,1	2.68	25,2	0.99
6S24FH20 (20-D24)	-24	31	-20	63,5	2.50	129,8	5.11	73,9	2.91	25,2	0.99
6S24FH24 (24-D24)	-24	38	-24	63,5	2.50	189,6	7.46	111,6	4.39	31,1	1.22
6S32FH24 (24-D32)	-32	38	-24	79,4	3.13	204,4	8.05	126,4	4.98	31,1	1.22
6S32FH32 (32-D32)	-32	51	-32	79,4	3.13	202,7	7.98	124,7	4.91	42,1	1.66

SAE Code 62 Flange (FHD)

22.5° Elbow

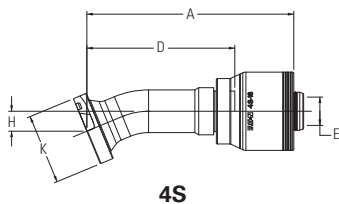

Part Number	Terminal End	Hose Size		Flange Head Dia. K Ø		A		D		E Ø		H	
	Dash size	DN	Dash size	mm	in	mm	in	mm	in	mm	in	mm	in
4S16FHD16 (16-N03)	-16	25	-16	47,7	1.88	140,0	5.51	100,1	3.94	19,2	0.76	13,5	0.53
4S20FHD16 (16-N04)	-20	25	-16	54,0	2.13	160,9	6.33	121,2	4.77	19,2	0.76	16,3	0.64
4S32FHD32 (32-N06)	-32	51	-32	79,4	3.13	269,6	10.61	191,5	7.54	42,1	1.66	23,5	0.93

4S Fittings

For use with hoses:

H430-6,-8,-10,-12,-16,-20,-24,-32;
 H430R-6,-8,-10,-12,-16,-20,-24,-32;
 H464-12,-16,-20,-24,-32;
 H471-12,-16,-20,-24; EC600-12,-16;
 EC525-12,-16,-20,-24,-32; EC810-12,-16

6S Fittings

For use with hoses:

H471-32;
 EC600-20;
 EC810-20,-24,-32

Crimp fittings

Spiral hose fittings
 (4S/6S Series)

H

SAE Code 62 Flange (FHF)

30° Elbow

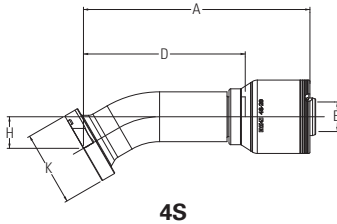

Part Number	Terminal End		Hose Size		Flange Head Dia. K Ø		A		D		E Ø		H	
	Dash size	DN	Dash size	mm	in	mm	in	mm	in	mm	in	mm	in	
4S24FHF20 (20-N25)	-24	31	-20	63,5	2.50	192,6	7.58	137,6	5.42	25,2	0.99	26,8	1.06	
4S32FHF32 (32-N26)	-32	51	-32	79,4	3.13	265,8	10.47	187,8	7.39	42,1	1.66	33,9	1.34	

SAE Code 62 Flange (FHA)

45° Elbow

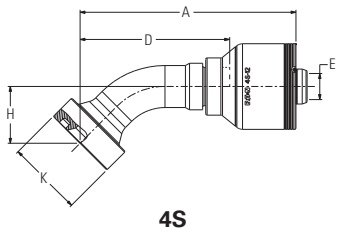

Part Number	Terminal End		Hose Size		Flange Head Dia. K Ø		A		D		E Ø		H	
	Dash size	DN	Dash size	mm	in	mm	in	mm	in	mm	in	mm	in	
4S8FHA8 (08-D41)	-8	12	-8	31,8	1.25	77,5	3.05	50,3	1.98	9,1	0.36	19,8	0.78	
4S12FHA8 (08-D42)	-12	12	-8	41,3	1.63	91,4	3.60	64,3	2.53	9,6	0.38	25,7	1.01	
4S12FHA12 (12-D42)	-12	19	-12	41,3	1.63	113,8	4.48	77,6	3.06	14,2	0.56	27,0	1.06	
4S16FHA12 (12-D46)	-16	19	-12	47,7	1.88	128,0	5.04	91,7	3.61	14,2	0.56	32,0	1.26	
4S12FHA16 (16-D42)	-12	25	-16	41,3	1.63	116,9	4.60	77,2	3.04	15,1	0.59	27,0	1.06	
4S16FHA16 (16-D46)	-16	25	-16	47,7	1.88	130,9	5.15	91,2	3.59	19,2	0.76	32,0	1.26	
4S20FHA16 (16-D50)	-20	25	-16	54,0	2.13	150,2	5.91	110,5	4.35	19,2	0.76	39,0	1.54	
4S20FHA20 (20-D50)	-20	31	-20	54,0	2.13	166,6	6.56	111,6	4.39	25,2	0.99	39,0	1.54	
4S24FHA20 (20-D54)	-24	31	-20	63,5	2.50	183,2	7.21	128,2	5.05	25,2	0.99	45,0	1.77	
4S24FHA24 (24-D54)	-24	38	-24	63,5	2.50	214,1	8.43	136,1	5.36	31,1	1.22	45,0	1.77	
4S32FHA24 (24-D62)	-32	38	-24	79,4	3.13	251,0	9.88	173,0	6.81	31,1	1.22	57,5	2.26	
4S32FHA32 (32-D62)	-32	51	-32	79,4	3.13	253,9	10.00	175,9	6.93	42,1	1.66	57,5	2.26	
6S	Dash size	DN	Dash size	mm	in	mm	in	mm	in	mm	in	mm	in	
6S20FHA20 (20-D50)	-20	31	-20	54,0	2.13	167,6	6.60	111,6	4.39	25,2	0.99	39,0	1.54	
6S24FHA20 (20-D54)	-24	31	-20	63,5	2.50	184,2	7.25	128,2	5.05	25,2	0.99	45,0	1.77	
6S24FHA24 (24-D54)	-24	38	-24	63,5	2.50	214,1	8.43	136,1	5.36	31,1	1.22	45,0	1.77	
6S32FHA24 (24-D62)	-32	38	-24	79,4	3.13	251,0	9.88	173,0	6.81	31,1	1.22	57,5	2.26	
6S32FHA32 (32-D62)	-32	51	-32	79,4	3.13	253,9	10.00	175,9	6.93	42,1	1.66	57,5	2.26	

Crimp fittings

Spiral hose fittings
(4S/6S Series)

4S Fittings

For use with hoses:

- H430-6,-8,-10,-12,-16,-20,-24,-32;
- H430R-6,-8,-10,-12,-16,-20,-24,-32;
- H464-12,-16,-20,-24,-32;
- H471-12,-16,-20,-24; EC600-12,-16;
- EC525-12,-16,-20,-24,-32; EC810-12,-16

6S Fittings

For use with hoses:

- H471-32;
- EC600-20;
- EC810-20,-24,-32

SAE Code 62 Flange (FHG)

60° Elbow

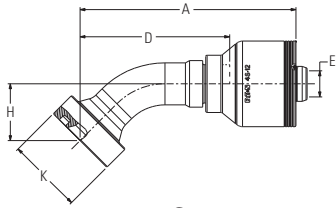

4S

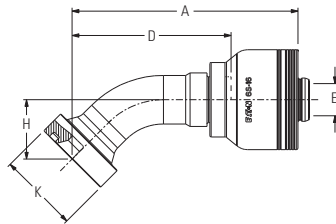

6S

Part Number	Terminal End	Hose Size		Flange Head Dia. K Ø		A		D		E Ø		H					
		Dash size	DN	Dash size	mm	in	mm	in	mm	in	mm	in	mm	in			
4S12FHG12 (12-N52)	-12	19	-12	41,3	1.63	133,9	5.27	97,7	3.85	14,2	0.56	37,6	1.48				
				4S16FHG16 (16-N53)	-16	25	-16	47,7	1.88	156,4	6.16	116,6	4.59	19,2	0.76	44,6	1.76
				4S32FHG32 (32-N56)	-32	51	-32	79,4	3.13	309,1	12.17	231,1	9.10	42,1	1.66	85,8	3.38
6S	Dash size	DN	Dash size	mm	in	mm	in	mm	in	mm	in	mm	in				
														6S20FHG20 (20-N54)	-20	31	-20

SAE Code 62 Flange (FHE)

67.5° Elbow

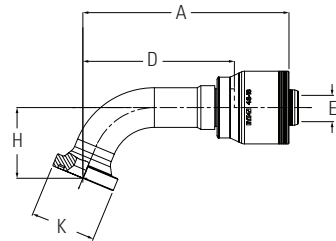

4S

Part Number	Terminal End	Hose Size		Flange Head Dia. K Ø		A		D		E Ø		H	
		Dash size	DN	Dash size	mm	in	mm	in	mm	in	mm	in	mm
4S32FHE32 (32-N66)	-32	51	-32	79,4	3.13	297,0	11.69	219,0	8.62	42,1	1.66	99,3	3.91

4S Fittings

For use with hoses:

H430-6,-8,-10,-12,-16,-20,-24,-32;
 H430R-6,-8,-10,-12,-16,-20,-24,-32;
 H464-12,-16,-20,-24,-32;
 H471-12,-16,-20,-24; EC600-12,-16;
 EC525-12,-16,-20,-24,-32; EC810-12,-16

6S Fittings

For use with hoses:

H471-32;
 EC600-20;
 EC810-20,-24,-32

Crimp fittings

Spiral hose fittings
 (4S/6S Series)

SAE Code 62 Flange (FHB)

90° Elbow

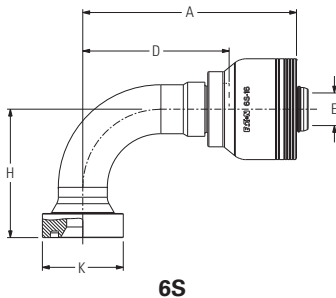
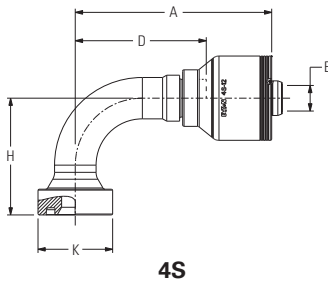

Part Number	Terminal End	Hose Size		Flange Head Dia. K Ø		A		D		E Ø		H	
		Dash size	DN	Dash size	mm	in	mm	in	mm	in	mm	in	mm
4S8FHB8 (08-D71)	-8	12	-8	31,8	1.25	69,5	2.74	42,3	1.67	9,1	0.36	41,4	1.63
4S12FHB8 (08-D72)	-12	12	-8	41,3	1.63	85,1	3.35	57,9	2.28	9,6	0.38	54,0	2.13
4S12FHB12 (12-D72)	-12	19	-12	41,3	1.63	108,5	4.27	72,3	2.85	14,2	0.56	59,0	2.32
4S16FHB12 (12-D76)	-16	19	-12	47,7	1.88	122,9	4.84	86,6	3.41	14,2	0.56	71,0	2.80
4S16FHB16 (16-D76)	-16	25	-16	47,7	1.88	125,5	4.94	86,1	3.39	19,2	0.76	71,0	2.80
4S16FHB16.120 (16-D76)	-16	25	-16	47,7	1.88	126,0	4.96	86,2	3.39	19,2	0.76	120,0	4.72
4S20FHB16 (16-D80)	-20	25	-16	54,0	2.13	145,3	5.72	105,4	4.15	19,2	0.76	89,0	3.50
4S16FHB20 (20-D76)	-16	31	-20	47,7	1.88	147,1	5.79	91,9	3.62	25,2	0.99	71,0	2.80
4S20FHB20 (20-D80)	-20	31	-20	54,0	2.13	161,5	6.36	106,5	4.19	25,2	0.99	89,0	3.50
4S20FHB20.120 (20-D80)	-20	31	-20	54,0	2.13	161,5	6.36	106,5	4.19	25,2	0.99	120,0	4.72
4S24FHB20 (20-D84)	-24	31	-20	63,5	2.50	178,0	7.01	123,0	4.84	25,2	0.99	104,0	4.09
4S24FHB24 (24-D84)	-24	38	-24	63,5	2.50	208,9	8.22	130,8	5.15	31,1	1.22	104,0	4.09
4S32FHB24 (24-D92)	-32	38	-24	79,4	3.13	247,4	9.74	169,4	6.67	31,1	1.22	138,0	5.43
4S32FHB32 (32-D92)	-32	51	-32	79,4	3.13	250,3	9.85	172,2	6.78	42,1	1.66	138,0	5.43
6S	Dash size	DN	Dash size	mm	in	mm	in	mm	in	mm	in	mm	in
6S16FHB20 (20-D76)	-16	31	-20	47,7	1.88	147,9	5.82	91,9	3.62	25,2	0.99	71,0	2.80
6S20FHB20 (20-D80)	-20	31	-20	54,0	2.13	162,5	6.40	106,5	4.19	25,2	0.99	89,0	3.50
6S24FHB20 (20-D84)	-24	31	-20	63,5	2.50	179,0	7.05	123,0	4.84	25,2	0.99	104,0	4.09
6S24FHB24 (24-D84)	-24	38	-24	63,5	2.50	208,9	8.22	130,8	5.15	31,1	1.22	104,0	4.09
6S32FHB24 (24-D92)	-32	38	-24	79,4	3.13	247,4	9.74	169,4	6.67	31,1	1.22	138,0	5.43
6S32FHB32 (32-D92)	-32	51	-32	79,4	3.13	250,3	9.85	172,2	6.78	42,1	1.66	138,0	5.43

Crimp fittings

Spiral hose fittings
(4S/6S Series)

H

4S Fittings

For use with hoses:

H430-6,-8,-10,-12,-16,-20,-24,-32;
H430R-6,-8,-10,-12,-16,-20,-24,-32;
H464-12,-16,-20,-24,-32;
H471-12,-16,-20,-24; EC600-12,-16;
EC525-12,-16,-20,-24,-32; EC810-12,-16

6S Fittings

For use with hoses:

H471-32;
EC600-20;
EC810-20,-24,-32

CAT® Flange (CT)

Straight

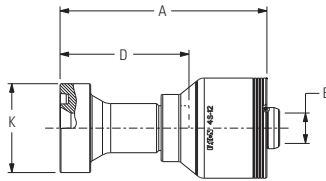

4S

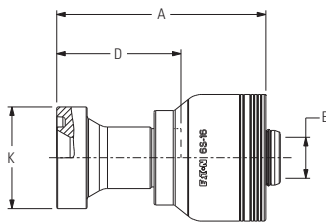

6S

Note: Reference page H-89
for Cat-Flange replacement
"D" ring

Part Number	Terminal End	Hose Size		Flange Head Dia. K Ø		A		D		E Ø	
		DN	Dash size	mm	in	mm	in	mm	in	mm	in
4S	Dash size										
4S12CT12 (12-K12)	-12	19	-12	41,3	1.63	96,2	3.79	60,0	2.36	14,2	0.56
4S16CT12 (12-K16)	-16	19	-12	47,6	1.87	94,9	3.74	58,7	2.31	14,2	0.56
4S16CT16 (16-K16)	-16	25	-16	47,6	1.87	102,1	4.02	62,3	2.45	19,2	0.76
4S20CT16 (16-K20)	-20	25	-16	54,0	2.13	104,8	4.13	65,0	2.56	19,2	0.76
4S20CT20 (20-K20)	-20	31	-20	54,0	2.13	124,5	4.90	69,1	2.72	25,2	0.99
4S24CT20** (20-K24)	-24	31	-20	63,5	2.50	130,9	5.15	75,9	2.99	25,2	0.99
4S24CT24 (24-K24)	-24	38	-24	63,5	2.50	195,0	7.68	117,0	4.61	31,1	1.22
4S32CT24 (24-K32)	-32	38	-24	79,4	3.13	206,0	8.11	128,0	5.04	31,1	1.22
4S32CT32 (32-K32)	-32	51	-32	79,4	3.13	208,9	8.22	130,9	5.15	42,1	1.66
6S	Dash size										
6S20CT20 (20-K20)	-20	31	-20	54,0	2.13	125,2	4.93	69,1	2.72	25,2	0.99
6S24CT20 (20-K24)	-24	31	-20	63,5	2.50	131,8	5.19	75,9	2.99	25,2	0.99
6S24CT24 (24-K24)	-24	38	-24	63,5	2.50	195,0	7.68	117,0	4.61	31,1	1.22
6S32CT24 (24-K32)	-32	38	-24	79,4	3.13	206,0	8.11	128,0	5.04	31,1	1.22
6S32CT32 (32-K32)	-32	51	-32	79,4	3.13	208,9	8.22	130,9	5.15	42,1	1.66

4S Fittings

For use with hoses:

H430-6,-8,-10,-12,-16,-20,-24,-32;
H430R-6,-8,-10,-12,-16,-20,-24,-32;
H464-12,-16,-20,-24,-32;
H471-12,-16,-20,-24; EC600-12,-16;
EC525-12,-16,-20,-24,-32; EC810-12,-16

6S Fittings

For use with hoses:

H471-32;
EC600-20;
EC810-20,-24,-32

Crimp fittings

Spiral hose fittings
(4S/6S Series)

H

CAT® Flange (CTA)

45° Elbow

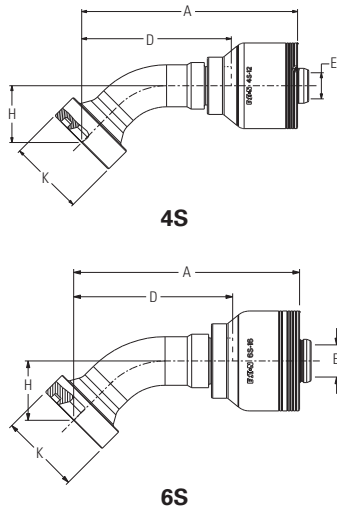

Part Number	Terminal End	Hose Size		Flange Head Dia. K Ø		A		D		E Ø		H	
		DN	Dash size	mm	in	mm	in	mm	in	mm	in	mm	in
4S	Dash size	DN	Dash size	mm	in	mm	in	mm	in	mm	in	mm	in
4S12CTA12 (12-K42)	-12	19	-12	41,3	1,63	117,7	4,63	81,5	3,21	14,2	0,56	30,9	1,22
4S16CTA12 (12-K46)	-16	19	-12	47,6	1,87	131,2	5,17	95,0	3,74	14,2	0,56	35,3	1,39
4S16CTA16 (16-K46)	-16	25	-16	47,6	1,87	134,3	5,29	94,6	3,72	19,2	0,76	35,3	1,39
4S20CTA16 (16-K50)	-20	25	-16	54,0	2,13	153,0	6,02	113,2	4,46	19,2	0,76	41,8	1,65
4S20CTA20 (20-K50)	-20	31	-20	54,0	2,13	169,4	6,67	114,3	4,50	25,2	0,99	41,8	1,65
4S24CTA20** (20-K54)	-24	31	-20	63,5	2,50	184,3	7,26	129,1	5,08	25,2	0,99	46,2	1,82
4S24CTA24 (24-K54)	-24	38	-24	63,5	2,50	215,2	8,47	137,2	5,40	31,1	1,22	46,2	1,82
4S32CTA32 (32-K62)	-32	51	-32	79,4	3,13	255,1	10,04	177,0	6,97	42,1	1,66	58,7	1,31
6S	Dash size	DN	Dash size	mm	in	mm	in	mm	in	mm	in	mm	in
6S20CTA20 (20-K50)	-20	31	-20	54,0	2,13	170,3	6,70	114,3	4,50	25,2	0,99	41,8	1,65
6S24CTA20 (20-K54)	-24	31	-20	63,5	2,50	185,3	7,30	129,1	5,08	25,2	0,99	46,2	1,82
6S24CTA24 (24-K54)	-24	38	-24	63,5	2,50	215,2	8,47	137,2	5,40	31,1	1,22	46,2	1,82
6S32CTA24 (24-K62)	-32	38	-24	79,4	3,13	252,2	9,93	174,2	6,86	31,1	1,22	58,7	2,31
6S32CTA32 (32-K62)	-32	51	-32	79,4	3,13	255,1	10,04	177,0	6,97	42,1	1,66	58,7	2,31

CAT® Flange (CTD)

22.5° Elbow

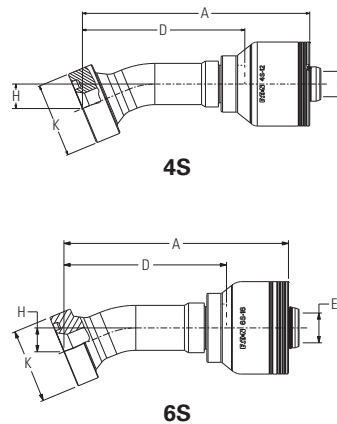

Part Number	Terminal End	Hose Size		Flange Head Dia. K Ø		A		D		E Ø		H	
		DN	Dash size	mm	in	mm	in	mm	in	mm	in	mm	in
4S	Dash size	DN	Dash size	mm	in	mm	in	mm	in	mm	in	mm	in
4S12CTD12 (12-BD12)	-12	19	-12	41,3	1,63	126,2	4,97	90,2	3,55	14,2	0,56	13,6	0,54
4S16CTD16 (16-BD16)	-16	25	-16	47,6	1,87	144,2	5,68	104,4	4,11	19,2	0,76	15,3	0,60
4S20CTD16 (16-BD20)	-20	25	-16	54,0	2,13	164,5	6,48	124,8	4,91	19,2	0,76	17,8	0,70
4S20CTD20** (20-BD20)	-20	31	-20	54,0	2,13	180,9	7,12	125,9	4,96	25,2	0,99	17,8	0,70
4S24CTD20** (20-BD24)	-24	31	-20	63,5	2,50	197,0	7,76	142,0	5,59	25,2	0,99	19,4	0,76
4S24CTD24 (24-BD24)	-24	38	-24	63,5	2,50	227,9	8,97	149,9	5,90	31,1	1,22	19,4	0,76
4S32CTD32 (32-BD32)	-32	51	-32	79,4	3,13	271,1	10,67	193,0	7,60	42,1	1,66	24,2	0,95
6S	Dash size	DN	Dash size	mm	in	mm	in	mm	in	mm	in	mm	in
6S20CTD20 (20-BD20)	-20	31	-20	54,0	2,13	181,9	7,16	125,9	4,96	25,2	0,99	17,8	0,70
6S24CTD20 (20-BD24)	-24	31	-20	63,5	2,50	198,0	7,80	142,0	5,59	25,2	0,99	19,4	0,76
6S24CTD24 (24-BD24)	-24	38	-24	63,5	2,50	227,9	8,97	149,9	5,90	31,1	1,22	19,4	0,76
6S32CTD32 (32-BD32)	-32	51	-32	79,4	3,13	271,1	10,67	193,0	7,60	42,1	1,66	24,2	0,95

Crimp fittings

Spiral hose fittings
(4S/6S Series)

4S Fittings

For use with hoses:

H430-6,-8,-10,-12,-16,-20,-24,-32;
H430R-6,-8,-10,-12,-16,-20,-24,-32;
H464-12,-16,-20,-24,-32;
H471-12,-16,-20,-24; EC600-12,-16;
EC525-12,-16,-20,-24,-32; EC810-12,-16

6S Fittings

For use with hoses:

H471-32;
EC600-20;
EC810-20,-24,-32

H

CAT® Flange (CTF)

30° Elbow

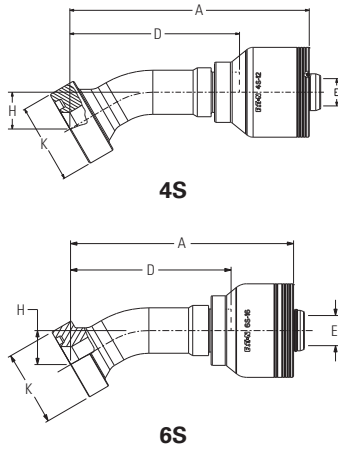

Part Number	Terminal End		Hose Size		Flange Head Dia. K Ø		A		D		E Ø		H	
	Dash size	DN	Dash size	mm	in	mm	in	mm	in	mm	in	mm	in	
4S														
4S12CTF12 (12-BD42)	-12	19	-12	41,3	1.63	124,2	4.89	88,0	3.46	14,2	0.56	19,1	0.75	
4S16CTF16 (16-BD46)	-16	25	-16	47,6	1.87	141,7	5.58	102,0	4.02	19,2	0.76	21,6	0.85	
4S20CTF16 (16-BD50)	-20	25	-16	54,0	2.13	161,7	6.37	122,0	4.80	19,2	0.76	25,3	1.00	
4S20CTF20** (20-BD50)	-20	31	-20	54,0	2.13	178,1	7.01	123,1	4.85	25,2	0.99	25,3	1.00	
4S24CTF20** (20-BD54)	-24	31	-20	63,5	2.50	194,0	7.64	138,9	5.47	25,2	0.99	27,7	1.09	
4S24CTF24 (24-BD54)	-24	38	-24	63,5	2.50	224,8	8.85	146,8	5.78	31,1	1.22	27,7	1.09	
4S32CTF32 (32-BD62)	-32	51	-32	79,4	3.13	267,3	10.52	189,2	7.45	42,1	1.66	34,8	1.37	
6S														
6S20CTF20 (20-BD50)	-20	31	-20	54,0	2.13	179,1	7.05	123,1	4.85	25,2	0.99	25,3	1.00	
6S24CTF20 (20-BD54)	-24	31	-20	63,5	2.50	194,9	7.67	138,9	5.47	25,2	0.99	27,7	1.09	
6S24CTF24 (24-BD54)	-24	38	-24	63,5	2.50	224,8	8.85	146,8	5.78	31,1	1.22	27,7	1.09	
6S32CTF24 (24-BD62)	-32	38	-24	79,4	3.13	264,3	10.41	186,3	7.34	31,1	1.22	34,8	1.37	
6S32CTF32 (32-BD62)	-32	51	-32	79,4	3.13	267,3	10.52	189,2	7.45	42,1	1.66	34,8	1.37	

CAT® Flange (CTG)

60° Elbow

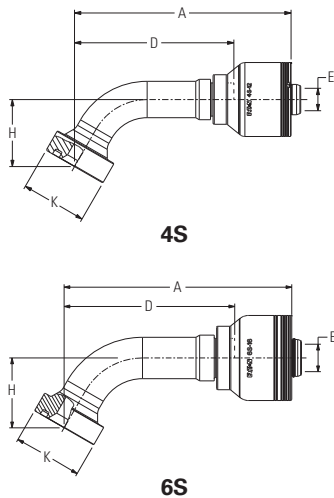

Part Number	Terminal End		Hose Size		Flange Head Dia. K Ø		A		D		E Ø		H	
	Dash size	DN	Dash size	mm	in	mm	in	mm	in	mm	in	mm	in	
4S														
4S12CTG12 (12-BD72)	-12	19	-12	41,3	1.63	136,6	5.38	100,5	3.96	14,2	0.56	42,3	1.67	
4S16CTG16 (16-BD76)	-16	25	-16	47,6	1.87	158,8	6.25	119,0	4.69	19,2	0.76	48,7	1.92	
4S20CTG16 (16-BD80)	-20	25	-16	54,0	2.13	185,2	7.29	145,5	5.73	19,2	0.76	59,2	2.33	
4S20CTG20** (20-BD80)	-20	31	-20	54,0	2.13	201,6	7.94	146,6	5.77	25,2	0.99	59,2	2.33	
4S24CTG20** (20-BD84)	-24	31	-20	63,5	2.50	223,3	8.79	168,3	6.63	25,2	0.99	66,6	2.62	
4S24CTG24 (24-BD84)	-24	38	-24	63,5	2.50	254,2	10.01	176,2	6.94	31,1	1.22	66,6	2.62	
4S32CTG32 (32-BD92)	-32	51	-32	79,4	3.13	310,0	12.20	231,9	9.13	42,1	1.66	87,3	3.44	
6S														
6S20CTG20 (20-BD80)	-20	31	-20	54,0	2.13	202,6	7.98	146,6	5.77	25,2	0.99	59,2	2.33	
6S24CTG20 (20-BD84)	-24	31	-20	63,5	2.50	224,3	8.83	168,3	6.63	25,2	0.99	66,6	2.62	
6S24CTG24 (24-BD84)	-24	38	-24	63,5	2.50	254,2	10.01	176,2	6.94	31,1	1.22	66,6	2.62	
6S32CTG24 (24-BD92)	-32	38	-24	79,4	3.13	307,0	12.09	229,0	9.02	31,1	1.22	87,3	3.44	
6S32CTG32 (32-BD92)	-32	51	-32	79,4	3.13	310,0	12.20	231,9	9.13	42,1	1.66	87,3	3.44	

4S Fittings

For use with hoses:

H430-6,-8,-10,-12,-16,-20,-24,-32;
 H430R-6,-8,-10,-12,-16,-20,-24,-32;
 H464-12,-16,-20,-24,-32;
 H471-12,-16,-20,-24; EC600-12,-16;
 EC525-12,-16,-20,-24,-32; EC810-12,-16

6S Fittings

For use with hoses:

H471-32;
 EC600-20;
 EC810-20,-24,-32

Crimp fittings

Spiral hose fittings
 (4S/6S Series)

CAT® Flange (CTB)

90° Elbow

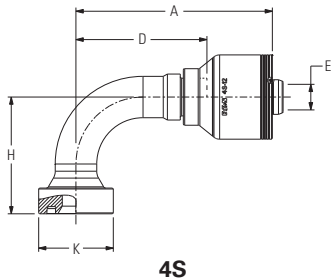

4S

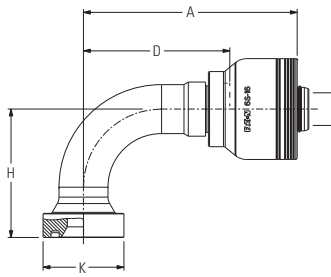

6S

Part Number	Terminal End		Hose Size		Flange Head Dia. K Ø		A		D		E Ø		H	
	Dash size	DN	Dash size	mm	in	mm	in	mm	in	mm	in	mm	in	
4S12CTB12 (12-K72)	-12	19	-12	41,3	1.63	108,5	4.27	72,3	2.85	14,2	0.56	64,5	2.54	
4S16CTB12 (12-K76)	-16	19	-12	47,6	1.87	122,8	4.83	86,6	3.41	14,2	0.56	75,7	2.98	
4S16CTB16 (16-K76)	-16	25	-16	47,6	1.87	126,0	4.96	86,2	3.39	19,2	0.76	75,7	2.98	
4S20CTB16 (16-K80)	-20	25	-16	54,0	2.13	145,2	5.72	105,4	4.15	19,2	0.76	92,9	3.66	
4S20CTB20 (20-K80)	-20	31	-20	54,0	2.13	161,5	6.36	106,5	4.19	25,2	0.99	92,9	3.66	
4S24CTB20** (20-K84)	-24	31	-20	63,5	2.50	178,0	7.01	123,0	4.84	25,2	0.99	105,6	4.16	
4S24CTB24 (24-K24)	-24	38	-24	63,5	2.50	208,9	8.22	130,9	5.15	31,1	1.22	105,7	4.16	
4S32CTB32 (32-K32)	-32	51	-32	79,4	3.13	250,3	9.85	172,2	6.78	42,1	1.66	139,7	5.50	
6S	Dash size	DN	Dash size	mm	in	mm	in	mm	in	mm	in	mm	in	
6S20CTB20 (20-K80)	-20	31	-20	54,0	2.13	162,5	6.40	106,5	4.19	25,2	0.99	92,9	3.66	
6S24CTB20 (20-K84)	-24	31	-20	63,5	2.50	179,0	7.05	123,0	4.84	25,2	0.99	105,6	4.16	
6S24CTB24 (24-K24)	-24	38	-24	63,5	2.50	208,9	8.22	130,9	5.15	31,1	1.22	105,7	4.16	
6S32CTB24 (24-K32)	-32	38	-24	79,4	3.13	247,4	9.74	169,4	6.67	31,1	1.22	139,7	5.50	
6S32CTB32 (32-K32)	-32	51	-32	79,4	3.13	250,3	9.85	172,2	6.78	42,1	1.66	139,7	5.50	

Crimp fittings

Spiral hose fittings
(4S/6S Series)

4S Fittings

For use with hoses:

H430-6,-8,-10,-12,-16,-20,-24,-32;
H430R-6,-8,-10,-12,-16,-20,-24,-32;
H464-12,-16,-20,-24,-32;
H471-12,-16,-20,-24; EC600-12,-16;
EC525-12,-16,-20,-24,-32; EC810-12,-16

6S Fittings

For use with hoses:

H471-32;
EC600-20;
EC810-20,-24,-32

H

CAT® Flange (CTE)

67.5° Elbow

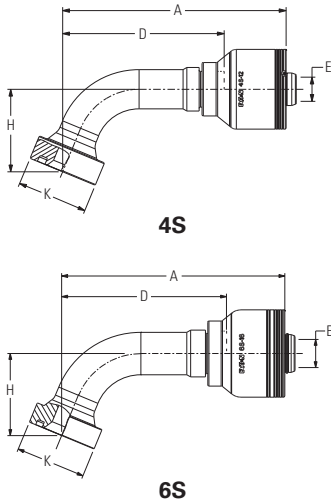

Part Number	Terminal End	Hose Size		Flange Head Dia. K Ø		A		D		E Ø		H	
	Dash size	DN	Dash size	mm	in	mm	in	mm	in	mm	in	mm	in
4S													
4S12CTE12 (12-BE12)	-12	19	-12	41,3	1.63	130,7	5.15	94,5	3.72	14,2	0.56	48,3	1.90
4S16CTE16 (16-BE16)	-16	25	-16	47,6	1.87	151,9	5.98	112,2	4.42	19,2	0.76	55,8	2.20
4S20CTE16 (16-BE20)	-20	25	-16	54,0	2.13	176,9	6.96	137,1	5.40	19,2	0.76	68,1	2.68
4S20CTE20** (20-BE20)	-20	31	-20	54,0	2.13	193,3	7.61	138,3	5.44	25,2	0.99	68,1	2.68
4S24CTE20** (20-BE24)	-24	31	-20	63,5	2.50	214,0	8.42	159,0	6.26	25,2	0.99	76,8	3.02
4S24CTE24 (24-BE24)	-24	38	-24	63,5	2.50	244,8	9.64	166,8	6.57	31,1	1.22	76,8	3.02
4S32CTE32 (32-BE32)	-32	51	-32	79,4	3.13	297,6	11.72	219,6	8.65	42,1	1.66	100,8	3.97
6S													
6S20CTE20 (20-BE20)	-20	31	-20	54,0	2.13	194,2	7.65	138,3	5.44	25,2	0.99	68,1	2.68
6S24CTE20 (20-BE24)	-24	31	-20	63,5	2.50	214,9	8.46	159,0	6.26	25,2	0.99	76,8	3.02
6S24CTE24 (24-BE24)	-24	38	-24	63,5	2.50	244,8	9.64	166,8	6.57	31,1	1.22	76,8	3.02
6S32CTE24 (24-BE32)	-32	38	-24	79,4	3.13	294,7	11.60	216,7	8.53	31,1	1.22	100,8	3.97
6S32CTE32 (32-BE32)	-32	51	-32	79,4	3.13	297,6	11.72	219,6	8.65	42,1	1.66	100,8	3.97

BSP Male Tapered Rigid (BT)

Straight

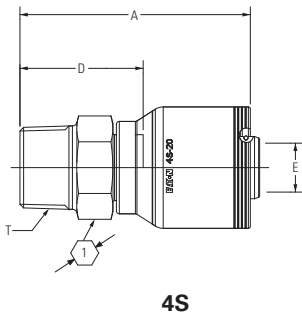

Part Number	Terminal End	Hose Size		Thread	A		D		E Ø		1
	Dash size	DN	Dash size	in	mm	in	mm	in	mm	in	mm
4S											
4S12BT12 (12-162)	-12	19	-12	R 3/4-14	84,0	3.31	47,7	1.88	14,2	0.56	27,0
4S16BT16 (16-166)	-16	25	-16	R 1-11	94,9	3.74	55,2	2.17	19,2	0.76	36,0
4S20BT20 (20-170)	-20	31	-20	R 1 1/4-11	118,4	4.66	63,3	2.49	25,2	0.99	46,0

"R" as part of thread size is ISO designation for tapered thread.

4S Fittings

For use with hoses:

H430-6,-8,-10,-12,-16,-20,-24,-32;
 H430R-6,-8,-10,-12,-16,-20,-24,-32;
 H464-12,-16,-20,-24,-32;
 H471-12,-16,-20,-24; EC600-12,-16;
 EC525-12,-16,-20,-24,-32; EC810-12,-16

6S Fittings

For use with hoses:

H471-32;
 EC600-20;
 EC810-20,-24,-32

Crimp fittings

Spiral hose fittings
 (4S/6S Series)

BSP Male Parallel Rigid (BP)

60° Cone Seat
 Straight

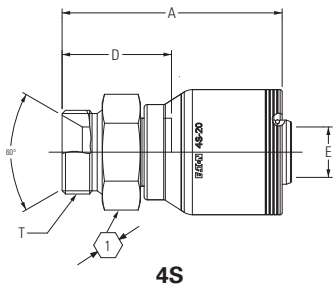

Part Number	Terminal End	Hose Size		Thread	A		D		E Ø		mm
		DN	Dash size		in	mm	in	mm	in	mm	
4S12BP12 (12-P62)	-12	19	-12	G 3/4-14	79,6	3.13	43,4	1.71	14,2	0.56	32,0
4S16BP16 (12-P66)	-16	25	-16	G 1-11	89,8	3.53	50,1	1.97	19,2	0.75	41,0
4S20BP20 (20-P67)	-20	31	-20	G 1 1/4-11	109,7	4.32	54,5	2.15	25,1	0.99	50,0

"G" as part of thread size is ISO designation for parallel thread.

Female BSPP Swivel (BF)

60° Cone Seat
 Straight

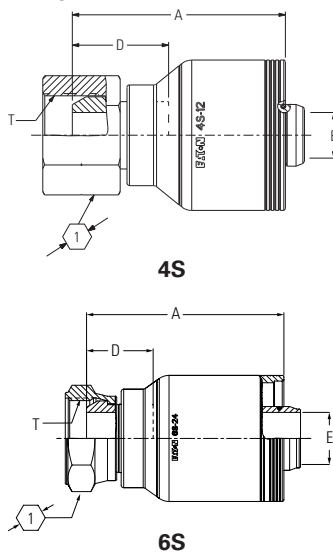

Part Number	Terminal End	Hose Size		Thread	A		D		E Ø		mm
		DN	Dash size		in	mm	in	mm	in	mm	
4S6BF6	-6	10	-6	G 3/8	46,4	1.83	21,1	0.83	6,7	0.26	22,0
4S8BF8 (08-358)	-8	12	-8	G 1/2	53,5	2.11	23,8	0.94	9,6	0.38	27,0
4S12BF12 (12-362)	-12	19	-12	G 3/4	66,2	2.61	29,9	1.18	14,2	0.56	32,0
4S16BF12 (12-366)	-16	19	-12	G 1	68,7	2.70	32,3	1.27	14,2	0.56	41,0
4S16BF16 (16-366)	-16	25	-16	G 1	71,0	2.80	32,3	1.27	19,2	0.76	41,0
4S20BF16 (16-370)	-20	25	-16	G 1 1/4	72,5	2.85	32,7	1.29	19,2	0.76	50,0
4S20BF20 (20-370)	-20	31	-20	G 1 1/4	82,8	3.26	32,7	1.29	25,2	0.99	50,0
4S24BF24 (24-374)	-24	38	-24	G 1 1/2	117,9	4.64	39,8	1.57	31,1	1.22	55,0
4S32BF32 (32-375)	-32	51	-32	G 2	121,0	4.76	43,0	1.69	42,1	1.66	70,0
6S	Dash size	DN	Dash size	in	mm	in	mm	in	mm	in	mm
6S24BF24 (24-374)	-24	38	-24	G 1 1/2	117,9	4.64	39,8	1.57	31,1	1.22	55,0
6S32BF32 (32-375)	-32	51	-32	G 2	121,0	4.76	43,0	1.69	42,1	1.66	70,0

"G" as part of thread size is ISO designation for parallel thread.

Crimp fittings

Spiral hose fittings
(4S/6S Series)

4S Fittings

For use with hoses:

H430-6,-8,-10,-12,-16,-20,-24,-32;
H430R-6,-8,-10,-12,-16,-20,-24,-32;
H464-12,-16,-20,-24,-32;
H471-12,-16,-20,-24; EC600-12,-16;
EC525-12,-16,-20,-24,-32; EC810-12,-16

6S Fittings

For use with hoses:

H471-32;
EC600-20;
EC810-20,-24,-32

H

Female BSPP Swivel (BFA)

60° Cone Seat

45° Elbow

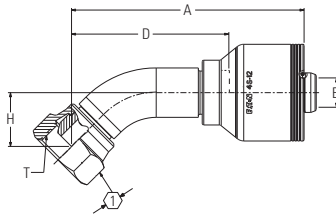

4S

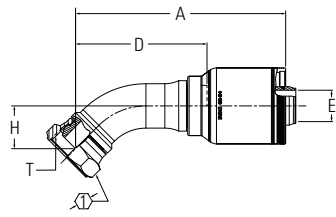

6S

Part Number	Terminal End		Hose Size		Thread		A		D		E Ø		H		1
	Dash size	DN	Dash size	in	mm	in	mm	in	mm	in	mm	in	mm	in	
4S6BFA6	-6	10	-6	G 3/8	73,8	2.91	48,5	1.91	6,7	0.26	19,0	0.75	22,0		
4S8BFA8	-8	12	-8	G 1/2	91,5	3.60	61,8	2.43	9,6	0.38	24,8	0.98	27,0		
4S12BFA12 (12-52P)	-12	19	-12	G 3/4	112,3	4.42	75,9	2.99	14,2	0.56	26,0	1.02	32,0		
4S16BFA12 (12-56P)	-16	19	-12	G 1	115,8	4.56	79,5	3.13	14,2	0.56	30,0	1.18	41,0		
4S16BFA16 (16-56P)	-16	25	-16	G 1	130,3	5.13	90,6	3.57	19,2	0.76	30,0	1.18	41,0		
4S20BFA16 (16-60P)	-20	25	-16	G 1 1/4	133,0	5.24	93,4	3.68	19,2	0.76	34,0	1.34	50,0		
4S20BFA20 (20-60P)	-20	31	-20	G 1 1/4	149,5	5.89	99,1	3.90	25,2	0.99	34,0	1.34	50,0		
4S24BFA24 (24-64P)	-24	38	-24	G 1 1/2	208,3	8.20	130,3	5.13	31,1	1.22	42,4	1.67	55,0		
4S32BFA32 (32-65P)	-32	51	-32	G 2	248,4	9.78	170,4	6.71	42,1	1.66	54,1	2.13	70,0		
6S	Dash size	DN	Dash size	in	mm	in	mm	in	mm	in	mm	in	mm		
6S24BFA24 (24-64P)	-24	38	-24	G 1 1/2	208,3	8.20	130,3	5.13	31,1	1.22	42,4	1.67	55,0		
6S32BFA32 (32-65P)	-32	51	-32	G 2	248,4	9.78	170,4	6.71	42,1	1.66	54,1	2.13	70,0		

"G" as part of thread size is ISO designation for parallel thread.

4S Fittings

For use with hoses:

H430-6,-8,-10,-12,-16,-20,-24,-32;
H430R-6,-8,-10,-12,-16,-20,-24,-32;
H464-12,-16,-20,-24,-32;
H471-12,-16,-20,-24; EC600-12,-16;
EC525-12,-16,-20,-24,-32; EC810-12,-16

6S Fittings

For use with hoses:

H471-32;
EC600-20;
EC810-20,-24,-32

Crimp fittings

Spiral hose fittings
(4S/6S Series)

Female BSPP Swivel (BFB)

60° Cone Seat

90° Elbow

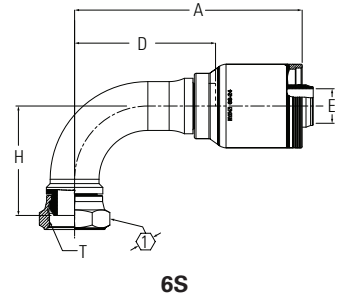
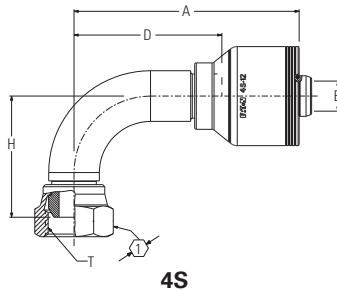

Part Number	Terminal End		Hose Size		Thread		A		D		E Ø		H		1
	Dash size	DN	Dash size	in	mm	in	mm	in	mm	in	mm	in	mm	in	mm
4S6BFB6	-6	10	-6	G 3/8	58,9	2.32	33,6	1.32	6,7	0.26	35,0	1.38	22,0		
4S8BFB8	-8	12	-8	G 1/2	63,9	2.52	34,2	1.35	9,6	0.38	37,5	1.48	27,0		
4S12BFB12 (12-82P)	-12	19	-12	G 3/4	105,9	4.17	69,6	2.74	14,2	0.56	57,0	2.24	32,0		
4S16BFB12 (12-86P)	-16	19	-12	G 1	105,9	4.17	69,6	2.74	14,2	0.56	68,0	2.68	41,0		
4S16BFB16 (16-86P)	-16	25	-16	G 1	125,5	4.94	85,8	3.38	19,2	0.76	68,0	2.68	41,0		
4S20BFB16 (16-90P)	-20	25	-16	G 1 1/4	125,5	4.94	85,8	3.38	19,2	0.76	79,0	3.11	50,0		
4S20BFB20 (20-90P)	-20	31	-20	G 1 1/4	145,0	5.71	95,0	3.74	25,2	0.99	79,0	3.11	50,0		
4S24BFB24 (24-94P)	-24	38	-24	G 1 1/2	205,1	8.07	127,0	5.00	31,1	1.22	98,6	3.88	55,0		
4S32BFB32 (32-95P)	-32	51	-32	G 2	245,7	9.67	167,6	6.60	42,1	1.66	125,3	4.93	70,0		
6S		DN	Dash size	in	mm	in	mm	in	mm	in	mm	in	mm		
6S24BFB24 (24-94P)	-24	38	-24	G 1 1/2	205,1	8.07	127,0	5.00	31,1	1.22	98,6	3.88	55,0		
6S32BFB32 (32-95P)	-32	51	-32	G 2	245,7	9.67	167,6	6.60	42,1	1.66	125,3	4.93	70,0		

"G" as part of thread size is ISO designation for parallel thread.

JIS Female swivel (JF)

30° Flare Seat

Straight

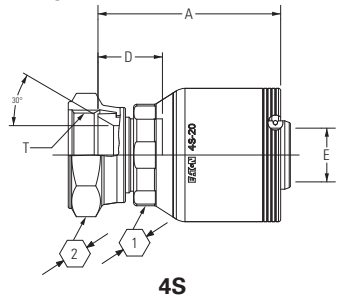

Part Number	Terminal End		Hose Size		Thread		A		D		E Ø		H		1	2
	Dash size	DN	Dash size	in	mm	in	mm	in	mm	in	mm	in	mm	in	mm	
4S6JF6	-6	10	-6	G 3/8	55,2	2.17	33,9	1.33	6,7	0.26	22,0	0.87	22,0			
4S8JF8	-8	12	-8	G 1/2	64,4	2.54	37,1	1.46	9,6	0.38	27,0	1.06	27,0			
4S12JF12 (12-12L)	-12	19	-12	G 3/4	62,4	2.46	26,2	1.03	14,2	0.56	30,0	1 3/16	32,0			
4S16JF16 (16-16L)	-16	25	-16	G 1	66,6	2.62	26,8	1.06	19,2	0.76	41,0	1 5/8	41,0			
4S20JF20 (20-20L)	-20	31	-20	G 1 1/4	85,5	3.37	30,2	1.19	25,2	0.99	46,0	1 13/16	50,0			

"G" as part of thread size is ISO designation for parallel thread.

Crimp fittings

Spiral hose fittings
(4S/6S Series)

4S Fittings

For use with hoses:

H430-6,-8,-10,-12,-16,-20,-24,-32;
H430R-6,-8,-10,-12,-16,-20,-24,-32;
H464-12,-16,-20,-24,-32;
H471-12,-16,-20,-24; EC600-12,-16;
EC525-12,-16,-20,-24,-32; EC810-12,-16

6S Fittings

For use with hoses:

H471-32;
EC600-20;
EC810-20,-24,-32

H

Komatsu Female Swivel (KF)

30° Flare Seat
Straight

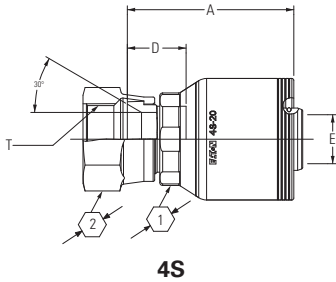

Part Number	Terminal End		Hose Size		Thread		A		D		E Ø		1	2
	4S	Dash size	DN	Dash size	Metric	mm	in	mm	in	mm	in	mm	in	mm
4S8KF8		-8	12	-8	M22X1.5	67,1	2.64	39,8	1.57	9,6	0.38	27,0	1.06	27,0
4S10KF10		-10	16	-10	M24X1.5	72,1	2.84	46,0	1.81	12,4	0.49	30,0	1 3/16	31,8
4S12KF12 (12-30K)		-12	19	-12	M30X1.5	62,4	2.46	26,2	1.03	14,2	0.56	30,0	1 3/16	36,0
4S16KF16 (16-33K)		-16	25	-16	M33X1.5	66,6	2.62	26,8	1.06	19,2	0.76	41,0	1 5/8	41,0
4S20KF20 (20-36K)		-20	31	-20	M36X1.5	85,5	3.37	30,2	1.19	25,2	0.99	46,0	1 13/16	46,0

Female Swivel DIN 24° seat (DL)

I.Rh DKO (Light)
Straight

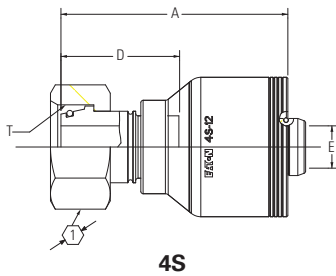

Part Number	Hose Size		Thread		A		D		E Ø		1
	4S	DN Dash size	Metric	mm	in	mm	in	mm	in	mm	
4S8DL6		10 -6	M16x1.5	50,5	1.99	25,2	0.99	6,7	0.26	19,0	
4S10DL6		10 -6	M18x1.5	51,2	2.01	25,9	1.02	6,7	0.26	22,0	
4S12DL8		12 -8	M22x1.5	58,3	2.30	28,6	1.13	9,6	0.38	27,0	
4S16DL10		16 -10	M26x1.5	59,2	2.33	29,8	1.17	12,8	0.50	32,0	
4S20DL12 (12-22C)		19 -12	M30X2	76,0	2.99	39,7	1.56	14,2	0.56	36,0	
4S25DL16 (16-28C)		25 -16	M36X2	79,7	3.14	40,3	1.59	19,2	0.76	41,0	
4S32DL20 (20-35C)		31 -20	M45X2	100,5	3.96	45,5	1.79	25,2	0.99	50,0	

Female Swivel DIN 24° Seat (DLB)

I.Rh DKO (Light)
90° Elbow

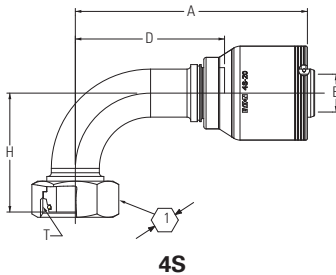

Part Number	Hose Size		Thread		A		D		E Ø		H		1
	4S	DN Dash size	Metric	mm	in	mm	in	mm	in	mm	in	mm	
4S20DLB12 (12-72D)		19 -12	M30X2	106,1	4.18	69,8	2.75	14,2	0.56	50,7	2.00	36,0	
4S32DLB20 (20-85D)		31 -20	M45X2	154,2	6.07	99,2	3.90	25,2	0.99	79,0	3.11	50,0	

4S Fittings

For use with hoses:

H430-6,-8,-10,-12,-16,-20,-24,-32;
 H430R-6,-8,-10,-12,-16,-20,-24,-32;
 H464-12,-16,-20,-24,-32;
 H471-12,-16,-20,-24; EC600-12,-16;
 EC525-12,-16,-20,-24,-32; EC810-12,-16

6S Fittings

For use with hoses:

H471-32;
 EC600-20;
 EC810-20,-24,-32

Crimp fittings

Spiral hose fittings
 (4S/6S Series)

Male DIN 24° Seat Rigid (EK)

S.Rh. DKO (Heavy)
 Straight

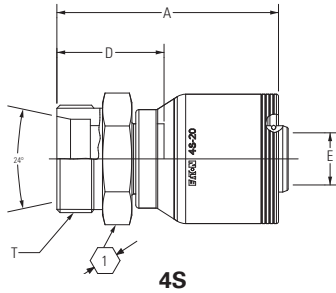

Part Number	Hose Size		Thread	A		D		E Ø		mm
	DN	Dash size		mm	in	mm	in	mm	in	
4S6EK6	10	-6	M18X1.5	45,5	1.79	24,2	0.95	6,7	0.26	19,0
4S8EK6	10	-6	M20X1.5	50,3	1.98	25,0	0.98	6,7	0.26	22,0
4S12EK8	12	-8	M24X1.5	58,0	2.28	28,3	1.11	9,6	0.38	27,0
4S16EK10	16	-10	M30X2	62,0	2.44	32,7	1.29	12,8	0.50	32,0
4S20EK12 (12-25F)	19	-12	M36X2	78,6	3.09	42,3	1.67	14,2	0.56	41,0
4S25EK16 (16-30F)	25	-16	M42X2	83,7	3.30	44,0	1.73	19,2	0.75	46,0
4S32EK20 (20-35F)	31	-20	M52X2	106,9	4.21	51,7	2.04	25,2	0.99	55,0

Female swivel DIN 24° seat (DS)

s.RH DKO (heavy)
 Straight

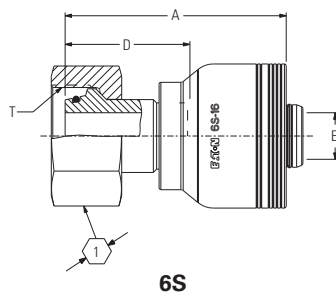
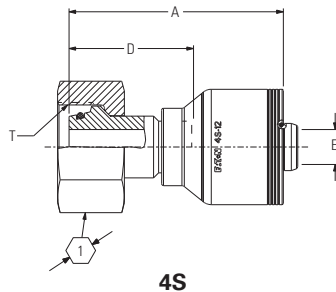

Part Number	Hose Size		Thread	A		D		E Ø		mm
	DN	Dash size		mm	in	mm	in	mm	in	
4S8DS6	10	-6	M20x1.5	53,8	2.12	28,5	1.12	6,7	0.26	24,0
4S10DS6	10	-6	M22x1.5	56,9	2.24	31,6	1.24	6,7	0.26	27,0
4S12DS8	12	-8	M24x1.5	62,4	2.46	32,7	1.29	9,6	0.38	30,0
4S16DS10	16	-10	M30x2	66,9	2.63	37,5	1.48	12,8	0.50	36,0
4S16DS12 (12-70C)	19	-12	M30X2	73,7	2.90	37,4	1.47	14,2	0.56	36,0
4S20DS12 (12-75C)	19	-12	M36X2	86,6	3.41	50,3	1.98	14,2	0.56	46,0
4S25DS12 (12-80C)	19	-12	M42X2	88,2	3.47	51,9	2.04	14,2	0.56	50,0
4S25DS16 (16-80C)	25	-16	M42X2	91,1	3.59	51,4	2.02	19,2	0.76	50,0
4S32DS16 (16-88C)	25	-16	M52X2	94,5	3.72	55,3	2.18	19,2	0.76	60,0
4S25DS20 (20-80C)	31	-20	M42X2	96,6	3.80	41,6	1.64	22,1	0.87	50,0
4S32DS20 (20-88C)	31	-20	M52X2	111,5	4.39	56,5	2.22	25,2	0.99	60,0
6S	DN	Dash size	Metric	mm	in	mm	in	mm	in	mm
6S32DS20 (20-88C)	31	-20	M52X2	112,5	4.43	56,5	2.22	25,2	0.99	60,0

Crimp fittings

Spiral hose fittings
(4S/6S Series)

4S Fittings

For use with hoses:

H430-6,-8,-10,-12,-16,-20,-24,-32;
H430R-6,-8,-10,-12,-16,-20,-24,-32;
H464-12,-16,-20,-24,-32;
H471-12,-16,-20,-24; EC600-12,-16;
EC525-12,-16,-20,-24,-32; EC810-12,-16

6S Fittings

For use with hoses:

H471-32;
EC600-20;
EC810-20,-24,-32

Female Swivel DIN 24° seat (DSA)

S.Rh DKO (heavy)
45° Elbow

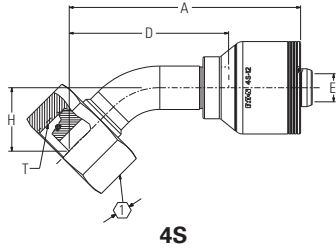

4S

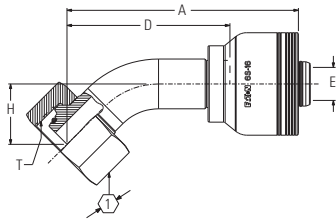

6S

Part Number	Hose Size		Thread	A		D		E Ø		H		1
	DN	Dash size		mm	in	mm	in	mm	in	mm	in	
4S8DSA6	10	-6	M20x1.5	66,3	2.61	41,0	1.61	6,7	0.26	17,2	0.68	24,0
4S12DSA8	12	-8	M24x1.5	86,7	3.41	57,0	2.24	9,6	0.38	24,0	0.94	30,0
4S16DSA10	16	-10	M30x2	87,1	3.43	57,7	2.27	12,0	0.47	24,7	0.97	36,0
4S20DSA12 (12-25E)	19	-12	M36x2	116,7	4.59	80,4	3.17	14,2	0.56	32,0	1.26	46,0
4S25DSA12 (12-30E)	19	-12	M42x2	130,8	5.15	94,4	3.72	14,2	0.56	35,0	1.38	50,0
4S25DSA16 (16-30E)	25	-16	M42x2	134,2	5.28	94,4	3.72	19,2	0.76	35,0	1.38	50,0
4S32DSA16 (16-88C)	25	-16	M52x2	145,1	5.71	105,3	4.15	19,2	0.76	39,0	1.54	60,0
4S32DSA20 (20-88C)	31	-20	M52x2	161,3	6.35	106,3	4.19	25,2	0.99	39,0	1.54	60,0
6S	DN	Dash size	Metric	mm	in	mm	in	mm	in	mm	in	mm
6S32DSA20 (20-88C)	31	-20	M52x2	162,4	6.39	106,3	4.19	25,2	0.99	39,0	1.54	60,0

Female swivel DIN 24° seat (DSB)

S.Rh DKO (heavy)
90° Elbow

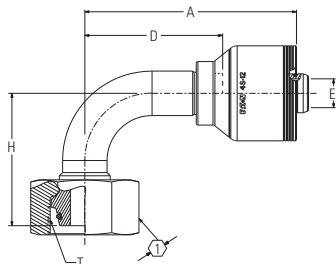

4S

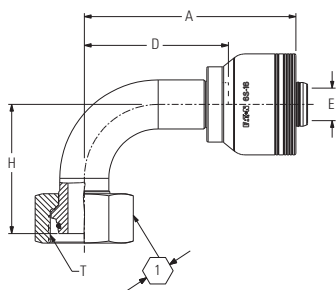

6S

Part Number	Hose Size		Thread	A		D		E Ø		H		1
	DN	Dash size		mm	in	mm	in	mm	in	mm	in	
4S8DSB6	10	-6	M20X1.5	55,9	2.20	34,6	1.36	6,7	0.26	35,3	1.39	24,0
4S10DSB6	10	-6	M22X1.5	59,8	2.35	38,5	1.52	6,7	0.26	42,0	1.65	27,0
4S12DSB8	12	-8	M24X1.5	77,7	3.06	48,0	1.89	9,6	0.38	45,3	1.78	30,0
4S16DSB10	16	-10	M30x2	82,0	3.23	52,6	2.07	12,8	0.50	52,0	2.05	36,0
4S20DSB12 (12-75E)	19	-12	M36x2	103,9	4.09	67,7	2.67	14,2	0.56	65,0	2.56	46,0
4S25DSB12 (12-80E)	19	-12	M42x2	122,7	4.83	86,4	3.40	14,2	0.56	76,0	2.99	50,0
4S25DSB16 (16-80E)	25	-16	M42x2	124,5	4.90	84,8	3.34	19,2	0.76	76,0	2.99	50,0
4S32DSB16 (16-88E)	25	-16	M52x2	136,7	5.38	97,0	3.82	19,2	0.76	89,0	3.50	60,0
4S32DSB20 (20-88E)	31	-20	M52x2	153,0	6.02	98,0	3.86	25,2	0.99	89,0	3.50	60,0
6S	DN	Dash size	Metric	mm	in	mm	in	mm	in	mm	in	mm
6S32DSB20 (20-88E)	31	-20	M52x2	154,2	6.07	98,0	3.86	25,2	0.99	89,0	3.50	60,0

Flange accessories

Split Flange Kits – SAE Standard

Pressure Series
(Ref. SAE Code 61) SAE J518

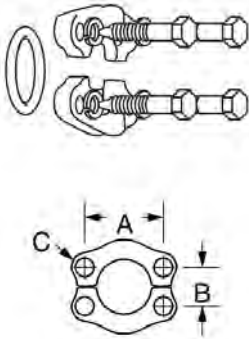

O-Ring Material

Buna-N 90 Durometer

Temperature range

-40°F to +250°F
(-40°C to + 121°C)

Standard o-ring complies with SAE specification SAE J515 Type CH

Included in kit

Nominal Flange Size	Part Number Complete Kit	Flange Halves 2 Req'd.	O-Ring	Bolts	Lock Washer	A	B	C	Bolt torque range Lb.-In.
1/2	SFK-08	8x251	8x252	8x853	8x254	1.50	.69	11/32	175-225
3/4	SFK-12	12x251	12x252	12x853	12x254	1.88	.88	13/32	250-350
1	SFK-16	16x251	16x252	12x853	12x254	2.06	1.03	13/32	325-425
1-1/4	SFK-20	20x251	20x252	20x853	20x254	2.31	1.19	15/32	425-550
1-1/2	SFK-24	24x251	24x252	24x853	24x254	2.75	1.41	17/32	550-700
2	SFK-32	32x251	32x252	24x853	24x254	3.06	1.69	17/32	650-800

Flanges conform to SAE J518.

Split Flange Kits – SAE High Pressure Series

(Ref. SAE Code 62) SAE J518

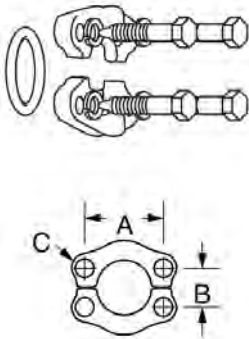

O-Ring Material

Buna-N 90 Durometer

Temperature range

-40°F to +250°F
(-40°C to + 121°C)

Standard o-ring complies with SAE specifications SAE J515 Type CH

Included in kit

Nominal Flange Size	Part Number Complete Kit	Flange Halves 2 Req'd.	O-Ring	Bolts	Lock Washer	A	B	C	Bolt torque range Lb.-In.
1/2	SFK62-8	8x262	8x252	8x853	8x254	1.57	.72	5/16	175-225
3/4	SFK62-12	12x262	12x252	12x863	12x254	2.00	.94	13/32	300-400
1	SFK62-16	16x262	16x252	12x863	12x254	2.25	1.09	15/32	500-600
1-1/4	SFK62-20	20x262	20x252	20x863	20x254	2.63	1.25	17/32	750-900
1-1/2	SFK62-24	24x262	24x252	24x863	24x264	3.12	1.44	21/32	1400-1600
2	SFK62-32	32x262	32x252	24x863	24x264	3.81	1.75	25/32	2400-2600

NOTE: Code 62 split flange kits cannot be used with Thick Flange™ hose Ends. Use existing split flanges. Flanges conform to SAE J518.

Cat-Flange D-Ring*

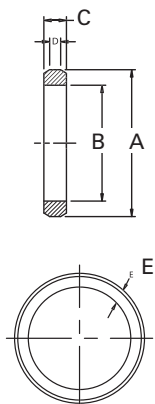

Material

Nitrile (Buna-N)

Temperature range

-40°F to +212°F
(-40°C to +100°C)

Part Number	A Ref		B Ref		C Ref		D Ref		E Ref	
	inch	mm	inch	mm	inch	mm	inch	mm	inch	mm
FF90319-12	1.27	32,3	1.00	25,4	.20	5,1	.10	2,5	.135	3,4
FF90319-16	1.52	36,6	1.25	31,8	.20	5,1	.10	2,5	.135	3,4
FF90319-20	1.77	45,0	1.50	38,1	.20	5,1	.10	2,5	.135	3,4
FF90319-24	2.03	51,6	1.76	44,7	.20	5,1	.10	2,5	.135	3,4
FF90319-32	2.78	70,6	2.52	64,0	.20	5,1	.10	2,5	.135	3,4

*To be used only with Cat-Flange hose ends.

Crimp fittings

Spiral hose fittings
(4S/6S Series)

H

Fitting for crimp die placement

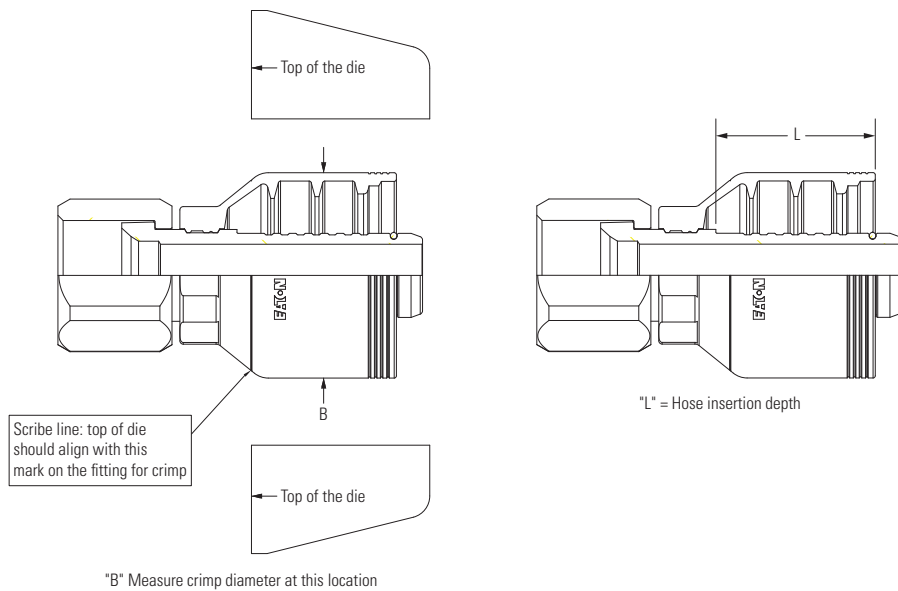

L Dimension

4S	mm	inches
4S-06	20,8	0.82
4S-08	28,2	1.11
4S-10	25,4	1.00
4S-12	36,2	1.43
4S-16	39,8	1.57
4S-20	55,1	2.17
4S-24	78,0	3.07
4S-32	78,0	3.07
6S	mm	inches
6S-16	39,8	1.57
6S-20	55,9	2.20
6S-24	78,0	3.07
6S-32	78,0	3.07

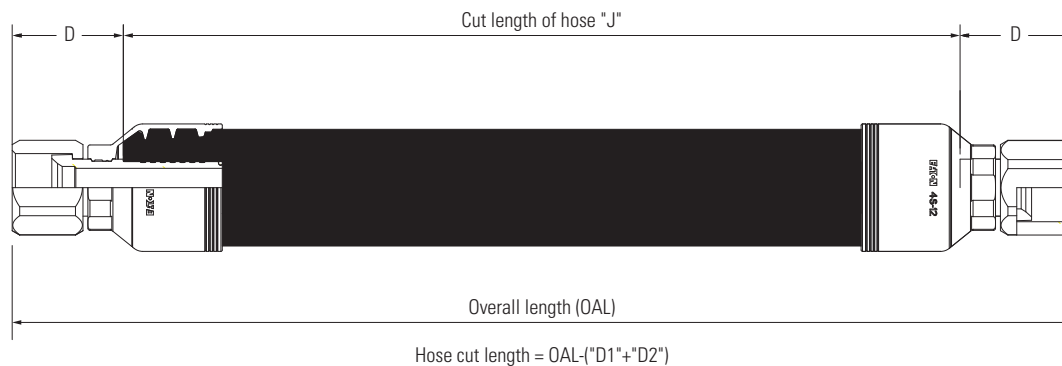

To determine the correct length of hose, subtract the cut-off factor for each end fitting from the overall length of assembly.

Conv-O-Crimp hose ends

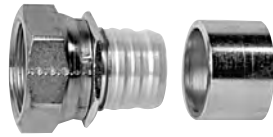

The unique Everflex Conv-O-Crimp hose end are shipped with factory-installed Teflon sleeves on the insert. This eliminates the time consuming, costly and subjective step of wrapping the hose end with Teflon tape before assembly. The end result is a hose assembly system that is second to none in ease of assembly fabrication. Common

industrial configurations are available in carbon steel and 316 stainless steel (wetted surfaces). Finished assemblies can be acquired from an authorized Everflex distributor or the factory.

Teflon is a trademark of The Chemours Company FC, LLC used under license by Eaton.

Male Pipe

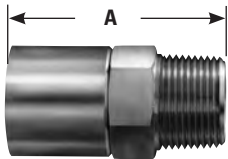

Hose Size	Hose I.D.	Part Number	Part No. Suffix Letter	Thread NPT	A Overall Length In.	Hose Cut-Off Factor†	Nominal I.D. In.
-8	1/2	8-108	A,B,C	1/2-14	2.33	1.38	.406
-12	3/4	12-112	A,B,C	3/4-14	2.48	1.38	.625
-16	1	16-116	A,B,C	1 1/2-11	2.95	1.76	.828
-20	1-1/4	20-120	A,B,C	1 1/4-11-1/2	2.98	1.79	1.078
-24	1-1/2	24-124	A,B,C	1 1/2-11-1/2	3.01	1.82	1.305
-32	2	32-132	A,B,C	2 1/2-11	3.43	1.98	1.781

A= Insert - 316 S.S., Nut & Collar - 304 S.S. B= Insert - 316 S.S., Nut - 304 S.S., Collar - Carbon Steel. C= All Components - Carbon Steel

Male Pipe inserts with Teflon sleeves installed



Hose Size	Carbon Steel Insert	Stainless Steel Insert	Carbon Steel Collar	Stainless Steel Collar
-8	800108-8-CZ	800108-8-316	870000-8-CZ	870000-8-304
-12	800112-12-CZ	800112-12-316	870000-12-CZ	870000-12-304
-16	800116-16-CZ	800116-16-316	870000-16-CZ	870000-16-304
-20	800120-20-CZ	800120-20-316	870000-20-CZ	870000-20-304
-24	800124-24-CZ	800124-24-316	870000-24-CZ	870000-24-304
-32	800132-32-CZ	800132-32-316	870000-32-CZ	870000-32-304

⚠ WARNING: Selection of the proper end fitting for the hose end application is essential to the proper operation and safe use of the hose and related equipment. Inadequate attention to the selection of the end fittings for your application can result in leaking or the hose end blowing off the hose, leading to serious personal injury, death or property damage.

† To determine the correct length of hose, subtract the cut-off factor for each end fitting from the overall length of assembly.

Material Code:

A= Insert - 316 S.S., Nut & Collar - 304 S.S.

B= Insert - 316 S.S., Nut - 304 S.S., Collar - Carbon Steel

C= All Components - Carbon Steel

Crimp fittings

Everflex hose ends

H

Conv-O-Crimp hose ends

JIC 37° swivel

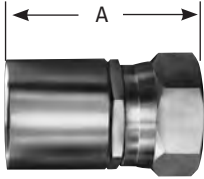

Hose Size	Hose I.D.	Catalog Number	Part No. Suffix Letter	Thread NPT	A Overall Length In.	Hose Cut-Off Factor†	Nominal I.D. In.
-8	1/2	8-608	A,B,C	3/4-16	1.82	1.32	.406
-12	3/4	12-612	A,B,C	1 1/6-12	2.01	1.46	.625
-16	1	16-616	A,B,C	1 5/16-12	2.14	1.55	.828
-20	1-1/4	20-620	A,B,C	1 5/8-12	2.20	1.64	1.078
-24	1-1/2	24-624	A,B,C	1 7/8-12	2.27	1.81	1.305
-32	2	32-632	A,B,C	2 1/2-12	2.62	2.10	1.781

JIC 37° swivel inserts with PTFE sleeves installed



Hose Size	Carbon Steel Insert	Stainless Steel Insert	Carbon Steel Collar	Stainless Steel Collar
-8	820008-8-CZ	820008-8-316	870000-8-CZ	870000-8-304
-12	820012-12-CZ	820012-12-316	870000-12-CZ	870000-12-304
-16	820016-16-CZ	820016-16-316	870000-16-CZ	870000-16-304
-20	820020-20-CZ	820020-20-316	870000-20-CZ	870000-20-304
-24	820024-24-CZ	820024-24-316	870000-24-CZ	870000-24-304
-32	820032-32-CZ	820032-32-316	870000-32-CZ	870000-32-304

Flange retainer

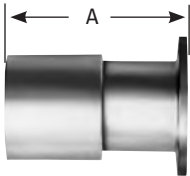

Hose Size	Hose I.D.	Catalog Number	Part No. Suffix Letter	A Overall Length In.	Hose Cut-Off Factor†	Nominal I.D. In.
-8	1/2	8-F00	A,B	2.13	1.31	.406
-12	3/4	12-F00	A,B	2.43	1.43	.625
-16	1	16-F00	A,B	2.58	1.50	.828
-20	1-1/4	20-F00	A,B	2.60	1.56	1.078
-24	1-1/2	24-F00	A,B	2.72	1.62	1.305
-32	2	32-F00	A,B	3.11	1.81	1.781

Flange ordered separately. See chart.

Sanitary Tri-Clamp

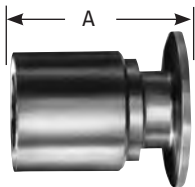

Hose Size	Hose I.D.	Catalog Number	Part No. Suffix Letter	A Overall Length In.	Hose Cut-Off Factor†	Nominal I.D. In.
-16	1	16-S16	A	2.14	1.06	.828
-24	1-1/2	24-S24	A	2.14	1.06	1.305
-32	2	32-S32	A	2.40	1.06	1.781

⚠ WARNING: Selection of the proper end fitting for the hose end application is essential to the proper operation and safe use of the hose and related equipment. Inadequate attention to the selection of the end fittings for your application can result in leaking or the hose end blowing off the hose, leading to serious personal injury, death or property damage.

† To determine the correct length of hose, subtract the cut-off factor for each end fitting from the overall length of assembly.

Material Code:

A= Insert - 316 S.S., Nut & Collar - 304 S.S.

B= Insert - 316 S.S., Nut - 304 S.S., Collar - Carbon Steel

C= All Components - Carbon Steel

Everswage



Everswage hose ends are permanently attached to Everflex Smooth Bore hose using a swaging process. The unique design of the Everswage collar allows a hose assembly fabricator to slide several collars at once on the hose. This significantly reduces the time required to fabricate an assembly. The most popular industrial fitting configurations, male pipe (NPT) and female JIC (SAE) swivels, are available in 300 Series stainless steel, carbon steel, or brass.

Part Number suffix letter

Example: B-1104-1

B = Brass

C = Carbon steel

S = Stainless steel

Note: The operating pressure of 1/2" I.D. hoses are lowered to 1500 psi and 5/8" I.D. hoses are lowered to 1250 psi when **brass Everswage fittings** are used.

WARNING: California Proposition 65, see page A-2.

Male pipe

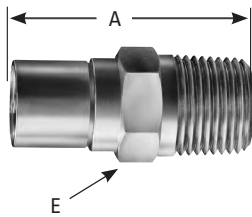

WARNING: California Proposition 65, see page A-2.

Hose I.D.	Part No. Pre-fix letter	Part number	Tube size	Thread size	A	Hose cut-off factor†	E
5/32	B,S	1103	1/8	1/8-27	1.19	3/4	1/2
3/16	B,C,S	1104-1	1/8	1/8-27	1.34	3/4	1/2
3/16	B,C,S	1104-2	1/4	1/4-18	1.47	7/8	9/16
1/4	B,C,S	1105-1	1/4	1/4-18	1.47	7/8	9/16
1/4	B, C	1105-1/8	1/8	1/8	1.34	15/16	9/16
5/16	B,C,S	1106-1	1/4	1/4-18	1.47	7/8	11/16
5/16	B,C,S	1106-2	3/8	3/8-18	1.53	15/16	11/16
5/16	B,S	1106-3	1/2	1/2	1.75	1-1/8	7/8
13/32	B,C,S	1108-1	3/8	3/8-18	1.84	1	3/4
13/32	B,C,S	1108-2	1/2	1/2-14	1.97	1-1/8	7/8
1/2	B,C,S	1110	1/2	1/2-14	1.97	1-3/16	7/8
5/8	B,C,S	1112	3/4	3/4-14	2.14	1-5/16	1-1/16
7/8	B,C,S	1116	1	1-11.5	2.94	1-5/8	1-3/8
7/8	B,C,S	1116Z†	1	1-11.5	2.94	1-5/8	1-3/8
1-1/8	B,C,S	1120Z†	1-1/4	1-1/4-11.5	3.03	1-3/4	1-3/4

All sizes are available in Brass. † The 16Z and 20Z sizes have a double stainless steel wire reinforcement.

37° JIC swivel

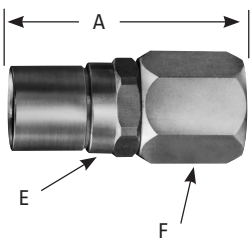

WARNING: California Proposition 65, see page A-2.

Hose I.D.	Part No. Pre-fix letter	Part number	Tube size	Thread size	A	Hose cut-off factor†	E	F
5/32	B,S	1303	3/16	3/8-24	1.38	0.85	1/2	
5/32	B	1303-4	1/4	7/16-20	1.38	0.90	1/2	9/16
3/16	B,C,S	1304	1/4	7/16-20	1.50	0.90	1/2	9/16
1/4	B,C,S	1305	5/16	1/2-20	1.63	0.94	9/16	5/8
5/16	B,C,S	1306	3/8	9/16-18	1.63	0.99	5/8	11/16
13/32	B,C,S	1308	1/2	3/4-16	2.00	1.18	3/4	7/8
1/2	B,C,S	1310	5/8	7/8-14	2.00	1.30	7/8	1
5/8	B,C,S	1312	3/4	1-1/6-12	2.25	1.38	1-1/16	1-1/4
7/8	B,C,S	1316	1	1-5/16-12	2.88	1.51	1-3/8	1-1/2
7/8	B,C,S	1316Z†	1	1-5/16-12	2.88	1.51	1-3/8	1-1/2
1-1/8	B,C,S	1320Z†	1-1/4	1-5/8-12	3.13	1.26	1-3/4	2

All sizes are available in Brass. † The 16Z and 20Z sizes have a double stainless steel wire reinforcement.

⚠ WARNING: Selection of the proper end fitting for the hose end application is essential to the proper operation and safe use of the hose and related equipment. Inadequate attention to the selection of the end fittings for your application can result in leaking or the hose end blowing off the hose, leading to serious personal injury, death or property damage.

† To determine the correct length of hose, subtract the cut-off factor for each end fitting from the overall length of assembly.

Crimp fittings

Everflex hose ends

For use with Everflex hoses
S, SC

To determine the correct length of hose, subtract the cut-off factor for each end fitting from the overall length of assembly.

H

Everswage

Part Number suffix letter

B = Brass

C = Carbon steel

S = Stainless steel

45° Brass swivel

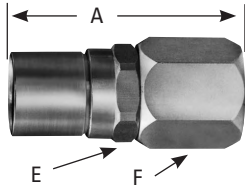

Hose I.D.	Part number	Tube size	Thread size	A	Hose cut-off factor†	E	F
3/16	Fitt. #30	1/4	7/16-20	1.50	0.90	1/2	9/16
1/4	Fitt. #31	5/16	1/2-20	1.50	0.94	9/16	5/8
5/16	Fitt. #32	3/8	5/8-18	1.63	0.96	5/8	3/4
13/32	Fitt. #33	1/2	3/4-16	2.00	1.18	3/4	7/8
1/2	Fitt. #34	5/8	7/8-14	2.13	1.30	7/8	1
5/8	Fitt. #35†	3/4	1-1/16-14	2.25	1.38	1-1/16	1-1/4

† Only fitting 35 has Carbon Steel nut.

WARNING: California Proposition 65, see page A-2.

Note: The operating pressure of 1/2" I.D. hoses are lowered to 1500 psi and 5/8" I.D. hoses are lowered to 1250 psi when **brass Everswage fittings** are used.

Female pipe

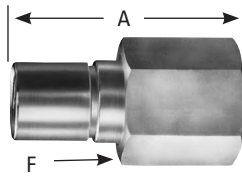

Hose I.D.	Part No. Pre-fix letter	Part number	Tube size	Thread size	A	Hose cut-off factor†	F
3/16	B	2104-1	1/8	1/8-27	1.28	11/16	9/16
3/16	B	2104-2	1/4	1/4-18	1.41	13/16	3/4
1/4	B,S	2105	1/4	1/4-18	1.41	13/16	3/4

All sizes are available in brass.

WARNING: California Proposition 65, see page A-2.

Stainless steel tube stub

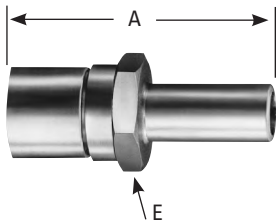

Hose I.D.	Part number	Tube size	Connector	A	Hose cut-off factor†	E
3/16	STE4-4	1/4" O.D.	0.188	1.50	1-1/8	9/16
1/4	STE4-5	1/4" O.D.	0.203	1.50	7/8	9/16
5/16	STE6-6	3/8" O.D.	0.266	1.63	1	11/16
13/32	STE8-8	1/2" O.D.	0.359	2.25	1-3/8	7/8
5/8	STE12-12	3/4" O.D.	0.578	2.38	1-1/2	1-1/16
7/8	STE16-16	1" O.D.	0.813	3.00	1-11/16	1-3/8

! **WARNING:** Selection of the proper end fitting for the hose end application is essential to the proper operation and safe use of the hose and related equipment. Inadequate attention to the selection of the end fittings for your application can result in leaking or the hose end blowing off the hose, leading to serious personal injury, death or property damage.

† To determine the correct length of hose, subtract the cut-off factor for each end fitting from the overall length of assembly.

For use with Everflex hoses
S, SC

To determine the correct length of hose, subtract the cut-off factor for each end fitting from the overall length of assembly.

Everswage

Part Number suffix letter

B = Brass

C = Carbon steel

S = Stainless steel

Laundry flange - Brass



WARNING: California Proposition 65, see page A-2.

Hose I.D.	Part number	Nominal ID	A	Hose cut-off factor†
5/16	B-6LFC	17/64	1	5/16

(Flange is plated carbon steel, copper gasket included)

Brass tire mold flange

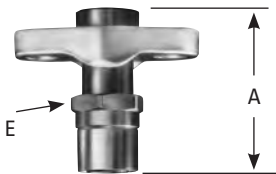

WARNING: California Proposition 65, see page A-2.

Hose I.D.	Part number	Nominal ID	A	Hose cut-off factor†	E
5/8	FITT. #60	37/64	2.63	1-5/8	1-1/16

(Flange is plated carbon steel)

Carbon steel paint spray swivel

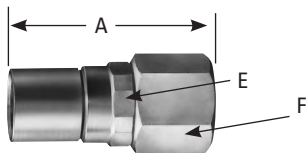

Hose I.D.	Part number	Thread size	A	Hose cut-off factor†	E	F
1/4	C-5PS	1/4 NPSM	1.50	0.82	9/16	5/8

⚠ WARNING: Selection of the proper end fitting for the hose end application is essential to the proper operation and safe use of the hose and related equipment. Inadequate attention to the selection of the end fittings for your application can result in leaking or the hose end blowing off the hose, leading to serious personal injury, death or property damage.

† To determine the correct length of hose, subtract the cut-off factor for each end fitting from the overall length of assembly.

Crimp fittings

Everflex hose ends

For use with Everflex hoses
S, SC

To determine the correct length of hose, subtract the cut-off factor for each end fitting from the overall length of assembly.

H

Everswage

SAE Brass male compression

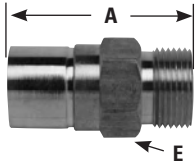

WARNING: California Proposition 65, see page A-2.

Hose I.D.	Part number	Tube size	Thread size	A	Hose cut-off factor†	E
1/2	FITT. #40	5/8	13/16-18	1.75	29/32	7/8

SAE Brass female compression

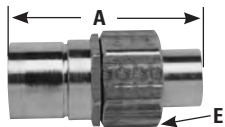

WARNING: California Proposition 65, see page A-2.

Hose I.D.	Part number	Tube size	Thread size	A	Hose cut-off factor†	E
1/2	FITT. #41	5/8	13/16-18	2.00	1-3/16	15/16

Note: The operating pressure of 1/2" I.D. hoses are lowered to 1500 psi and 5/8" I.D. hoses are lowered to 1250 psi when **brass Everswage fittings** are used.

Stainless steel power trim Straight

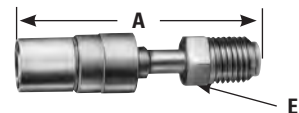

(316 Stainless steel wetted parts.)

Hose I.D.	Part number	Tube size	Thread size	A	Hose cut-off factor†	E
3/16	PT-S-4	3/16	3/8-24	1.88	1-7/16	3/8



WARNING: Selection of the proper end fitting for the hose end application is essential to the proper operation and safe use of the hose and related equipment. Inadequate attention to the selection of the end fittings for your application can result in leaking or the hose end blowing off the hose, leading to serious personal injury, death or property damage.

† To determine the correct length of hose, subtract the cut-off factor for each end fitting from the overall length of assembly.

For use with Everflex hoses
S, SC

To determine the correct length of hose, subtract the cut-off factor for each end fitting from the overall length of assembly.

Everswage

Stainless steel power trim 45° Elbow

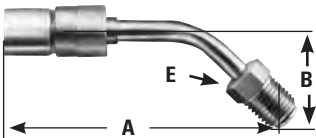

(316 Stainless steel wetted parts.)

Hose I.D.	Part number	Tube size	Thread size	A	Hose cut-off factor†	B	E
3/16	PT-45-4	3/16	3/8-24	2.75	2	3/4	3/8

Stainless steel power trim 90° Elbow

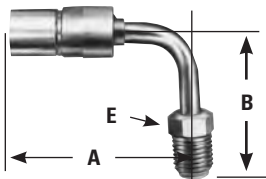

(316 Stainless steel wetted parts.)

Hose I.D.	Part number	Tube size	Thread size	A	Hose cut-off factor†	B	E
3/16	PT-90-4	3/16	3/8-24	2.00	1-1/2	1	3/8

Sanitary Tri clamp

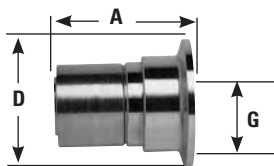

(316 Stainless steel wetted parts.)

Hose I.D.	Part number	Nominal I.D.	A	Hose cut-off factor†	D	G
1/2	10-S.37-316	.45	1.5	.6875	.985	.375
7/8	16-S.87-316	.81	2.0	.6875	1.984	.86

⚠ WARNING: Selection of the proper end fitting for the hose end application is essential to the proper operation and safe use of the hose and related equipment. Inadequate attention to the selection of the end fittings for your application can result in leaking or the hose end blowing off the hose, leading to serious personal injury, death or property damage.

† To determine the correct length of hose, subtract the cut-off factor for each end fitting from the overall length of assembly.

Crimp fittings

Everflex hose ends

For use with Everflex hoses
S, SC

To determine the correct length of hose, subtract the cut-off factor for each end fitting from the overall length of assembly.

H

Everswage components

Swage collars

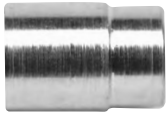

WARNING: California Proposition 65, see page A-2.

Hose I.D.	Part number	Part number suffix letter	JIC size
3/16	NC-4	B,C,S	1/4
1/4	NC-5	B,C,S	5/16
5/16	NC-6	B,C,S	3/8
13/32	NC-8	B,C,S	1/2
1/2	NC-10	B,C,S	5/8
5/8	NC-12	B,C,S	3/4
7/8	NC-16	B,C,S	1
7/8	NC-16Z	B,C,S	1
1-1/8	NC-20Z	B,C,S	1-1/4

All sizes are available in Brass.

Part Number suffix letter

B = Brass

C = Carbon steel

S = Stainless steel

Male pipe insert



WARNING: California Proposition 65, see page A-2.

Hose I.D.	Part number	Part number suffix letter	Tube size
3/16	NM2-4	B,C,S	1/8
3/16	NM4-4	B,C,S	1/4
1/4	NM4-5	B,C,S	5/16
5/16	NM4-6	B,C,S	1/4
5/16	NM6-6	B,C,S	3/8
13/32	NM6-8	B,C,S	3/8
13/32	NM8-8	B,C,S	1/2
1/2	NM8-10	B,C,S	1/2
5/8	NM12-12	B,C,S	1
7/8	NM16-16	B,C,S	1
1-1/8	NM20-20	B,C,S	1-1/4

All sizes are available in Brass.



WARNING: Selection of the proper end fitting for the hose end application is essential to the proper operation and safe use of the hose and related equipment. Inadequate attention to the selection of the end fittings for your application can result in leaking or the hose end blowing off the hose, leading to serious personal injury, death or property damage.

For use with Everflex hoses

S, SC

To determine the correct length of hose, subtract the cut-off factor for each end fitting from the overall length of assembly.

Everswage components

37° JIC female insert

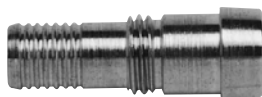

WARNING: California Proposition 65, see page A-2.

Hose I.D.	Part number	Part number suffix letter	JIC size
3/16	NJ-4	C,S	1/4
1/4	NJ-5	B,C,S	5/16
5/16	NJ-6	B,C,S	3/8
13/32	NJ-8	B,C,S	1/2
1/2	NJ-10	B,C,S	5/8
5/8	NJ-12	B,C,S	3/4
7/8	NJ-16	B,C,S	1
1-1/8	NJ-20	B,C,S	1-1/4

All sizes are available in Brass.

Part Number suffix letter

B = Brass

C = Carbon steel

S = Stainless steel

37° JIC female short collars

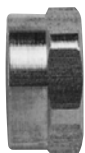

WARNING: California Proposition 65, see page A-2.

Hose I.D.	Part number	Part number suffix letter	JIC size
3/16	NJC-4	B,C,S	1/4
1/4	NJC-5	B,C,S	5/16
5/16	NJC-6	B,C,S	3/8
13/32	NJC-8	B,C,S	1/2
1/2	NJC-10	B,C,S	5/8
5/8	NJC-12	B,C,S	3/4
7/8	NJC-16	B,C,S	1
1-1/8	NJC-20	B,C,S	1-1/4

All sizes are available in Brass.



WARNING: Selection of the proper end fitting for the hose end application is essential to the proper operation and safe use of the hose and related equipment. Inadequate attention to the selection of the end fittings for your application can result in leaking or the hose end blowing off the hose, leading to serious personal injury, death or property damage.

37° JIC female nut



WARNING: California Proposition 65, see page A-2.

Hose I.D.	Part number	Part number suffix letter	JIC size
3/16	NNJ-4	B,C,S	1/4
1/4	NNJ-5	B,C,S	5/16
5/16	NNJ-6	B,C,S	3/8
13/32	NNJ-8	B,C,S	1/2
1/2	NNJ-10	B,C,S	5/8
5/8	NNJ-12	B,C,S	3/4
7/8	NNJ-16	B,C,S	1
1-1/8	NNJ-20	B,C,S	1-1/4

All sizes are available in Brass.



WARNING: Selection of the proper end fitting for the hose end application is essential to the proper operation and safe use of the hose and related equipment. Inadequate attention to the selection of the end fittings for your application can result in leaking or the hose end blowing off the hose, leading to serious personal injury, death or property damage.

Crimp fittings

Everflex hose ends

H

Everswage fittings - Bill of material cross reference

Top Assembly Catalog Number	Insert Part Number*	Collar Part Number	Top Assembly Catalog Number	Insert Part Number*	Collar Part Number
B-1112	NM12-12-B	NC-12-B	B-1303	NJIC-3-B	NC-3-B
C-1112	NM12-12-C	NC-12-C	S-1303	NJIC-3-S	NC-3-S
S-1112	NM12-12-S	NC-12-S	B-1303-4	NJIC4-3-B	NC-3-B
B-1116	NM16-16-B	NC-16-B	S-1303-4	NJIC4-3-S	NC-3-S
C-1116	NM16-16-C	NC-16-C	B-1304	NJICSAE-4-B	NC-4-B
S-1116	NM16-16-S	NC-16-S	C-1304	NJIC-4-C	NC-4-C
B-1103	NM2-3-B	NC-3-B	S-1304	NJIC-4-S	NC-4-S
S-1103	NM2-3-S	NC-3-S	B-1305	NJIC-5-B	NC-5-B
B-1104-1	NM2-4-B	NC-4-B	C-1305	NJIC-5-C	NC-5-C
C-1104-1	NM2-4-C	NC-4-C	S-1305	NJIC-5-S	NC-5-S
S-1104-1	NM2-4-S	NC-4-S	B-1306	NJIC-6-B	NC-6-B
B-1105-1/8	NM2-5-B	NC-5-B	C-1306	NJIC-6-C	NC-6-C
B-1116Z	NM16-16-B	NC-16Z-B	S-1306	NJIC-6-S	NC-6-S
C-1116Z	NM16-16-C	NC-16Z-C	B-1308	NJIC-8-B	NC-8-B
S-1116Z	NM16-16S	NC-16Z-S	C-1308	NJIC-8-C	NC-8-C
B-1120Z	NM20-20-B	NC-20Z-B	S-1308	NJIC-8-S	NC-8-S
C-1120Z	NM20-20-C	NC-20Z-C	B-1310	NJIC-10-B	NC-10-B
S-1120Z	NM20-20-S	NC-20Z-S	C-1310	NJIC-10-C	NC-10-C
B-1104-2	NM4-4-B	NC-4-B	S-1310	NJIC-10-S	NC-10-S
C-1104-2	NM4-4-C	NC-4-C	B-1312	NJIC-12-B	NC-12-B
S-1104-2	NM4-4-S	NC-4-S	C-1312	NJIC-12-C	NC-12-C
B-1105	NM4-5-B	NC-5-B	S-1312	NJIC-12-S	NC-12-S
C-1105	NM4-5-C	NC-5-C	B-1316	NJIC-16-B	NC-16-B
S-1105	NM4-5-S	NC-5-S	C-1316	NJIC-16-C	NC-16-C
B-1106-1	NM4-6-B	NC-6-B	S-1316	NJIC-16-S	NC-16-S
C-1106-1	NM4-6-C	NC-6-C	B-1316Z	NJIC-16-B	NC-16Z-B
S-1106-1	NM4-6-S	NC-6-S	C-1316Z	NJIC-16-C	NC-16Z-C
B-1106-2	NM6-6-B	NC-6-B	S-1316Z	NJIC-16-S	NC-16Z-S
C-1106-2	NM6-6-C	NC-6-C			
S-1106-2	NM6-6-S	NC-6-S	B-1320Z	NJIC-20-B	NC-20Z-B
B-1108-1	NM6-8-B	NC-8-B	C-1320Z	NJIC-20-C	NC-20Z-C
C-1108-1	NM6-8-C	NC-8-C	S-1320Z	NJIC-20-S	NC-20Z-S
S-1108-1	NM6-8-S	NC-8-S	B-2104-1	NF2-4-B	NC-4-B
B-1110	NM8-10-B	NC-10-B	B-2104-2	NF4-4-B	NC-4-B
C-1110	NM8-10-C	NC-10-C	B-2105	NF4-5-B	NC-5-B
S-1110	NM8-10-S	NC-10-S	S-2105	NF4-5-S	NC-5-S
B-1106-3	NM8-6-B	NC-6-B			
C-1106-3	NM8-6-C	NC-6-C	FITT. #40	NMC-10-B	NC-10-B
S-1106-3	NM8-6-S	NC-6-S			
B-1108-2	NM8-8-B	NC-8-B	PT-S-4	NPTS-4-S	NC-4-S
C-1108-2	NM8-8-C	NC-8-C	PT-45-4	NPT45-4-S	NC-4-S
S-1108-2	NM8-8-S	NC-8-S	PT-90-4	NPT90-4-S	NC-4-S
C-5PS	NPS-5-C	NC-5-C			
Fitt. #30	NSAE-4-B	NC-4-B			
Fitt. #32	NSAE-6-B	NC-6-B			
Fitt. #33	NSAE-8-B	NC-8-B			
Fitt. #34	NSAE-10-B	NC-10-B			
Fitt. #35	NSAE-12-B	NC-12-B			

Part Number suffix letter

- B** = Brass
- C** = Carbon steel
- S** = Stainless steel

WARNING: California Proposition 65, see page A-2.

* Insert Part Number includes nut and short collar

Field attachable fittings

1 Wire Braided hose

1R series I-2

2 Wire Braided hose

2R series I-5

009 'B' series I-8

057 'B' series I-9

100 'B' series I-11

105 'B' series I-14

338 'B' series I-15

069 'D' series I-18

213 'N' series I-20

247 'N' series I-23

FC800 Evercool I-28

E-Z Clip system

End connections & O-Rings I-31

Fittings I-33

Cages, clips & Lifesavers I-59

Aluminum Lifesaver I-60

Tool kit I-61

Tools I-61

Ordering & identifying I-62

Assembly instructions I-63



Field attachable

Braided hose - 1R series

Use with hose:
H180

Braided hose - 1R series

Male pipe

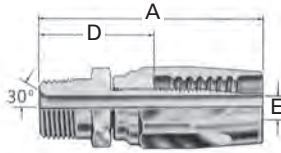

Assy part number	Nipple/nipple assy	New reusable socket	Thread size	Hose size	Dim A		Dim D		EØ	
					mm	in	mm	in	mm	in
1RA2MP4	4202-2-4S	1RA4	1/8-27	-04	55.1	2.17	28.7	1.13	4.3	0.17
1RA4MP4	4202-4-4S	1RA4	1/4-18	-04	59.9	2.36	33.5	1.32	4.3	0.17
1RA4MP6	4202-4-6S	1RA6	1/4-18	-06	68.1	2.68	39.4	1.55	7.6	0.30
1RA6MP6	4202-6-6S	1RA6	3/8-18	-06	68.1	2.68	39.4	1.55	7.9	0.31
1RA6MP8	4202-6-8S	1RA8	3/8-18	-08	71.6	2.82	34.3	1.35	9.9	0.39
1RA8MP8	4202-8-8S	1RA8	1/2-14	-08	78.0	3.07	40.6	1.60	9.9	0.39
1RA12MP12	4202-12-12S	1RA12	3/4-14	-12	90.2	3.55	49.5	1.95	15.5	0.61
1RA16MP16	4202-16-16S	1RA16	1-11 1/2	-16	108.0	4.25	54.1	2.13	20.8	0.82

SAE 37° (JIC) swivel

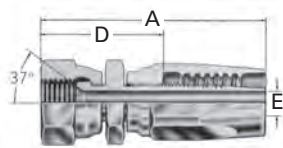

Assy part number	Nipple/nipple assy	New reusable socket	Thread size	Hose size	Dim A		Dim D		EØ	
					mm	in	mm	in	mm	in
1RA4FJ4	4103-4-4-4S	1RA4	7/16-20	-04	63.5	2.50	37.1	1.46	4.3	0.17
1RA6FJ6	4103-4-6-6S	1RA6	9/16-18	-06	73.9	2.91	45.2	1.78	7.9	0.31
1RA8FJ8	4103-4-8-8S	1RA8	3/4-16	-08	80.8	3.18	43.8	1.70	9.9	0.39
1RA12FJ12	4103-4-12S	1RA12	1 1/16-12	-12	96.5	3.80	55.9	2.20	15.5	0.61
1RA16FJ16	4103-4-16S	1RA16	1 5/16-12	-16	110.0	4.33	56.1	2.21	20.8	0.82

SAE 37° (JIC) male flare

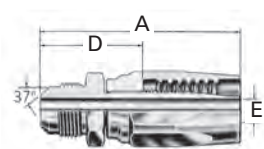

Assy part number	Nipple/nipple assy	New reusable socket	Thread size	Hose size	Dim A		Dim D		EØ	
					mm	in	mm	in	mm	in
1RA4MJ4	4203-4-4S	1RA4	7/16-20	-04	59.4	2.34	33.0	1.30	4.3	0.17
1RA6MJ6	4203-6-6S	1RA6	9/16-18	-06	67.8	2.67	39.1	1.54	7.9	0.31
1RA8MJ8	4203-8-8S	1RA8	3/4-16	-08	75.4	2.97	38.1	1.50	9.9	0.39
1RA12MJ12	4203-12S	1RA12	1 1/16-12	-12	93.0	3.66	52.3	2.06	15.5	0.61
1RA16MJ16	4203-16S	1RA16	1 5/16-12	-16	107.4	4.23	53.3	2.10	20.8	0.82

Use with hose:
H180

Field attachable

Braided hose - 1R series

SAE 37° (JIC) swivel
45° elbow

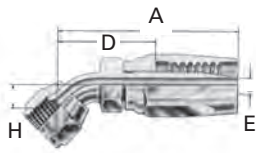

Assy part number	Nipple/nipple assy	New reusable socket	Thread size	Hose size	Dim A		Dim D		EØ		Dim H	
					mm	in	mm	in	mm	in	mm	in
1RA4FJA4	185287-4S	1RA4	7/16-20	-04	60.2	2.37	33.8	1.33	4.3	0.17	8.4	0.33
1RA6FJA6	185287-6S	1RA6	9/16-18	-06	69.9	2.75	41.1	1.62	7.9	0.31	9.9	0.39
1RA8FJA8	185287-8S	1RA8	3/4-16	-08	82.3	3.24	45.0	1.77	9.9	0.39	14.0	0.55
1RA12FJA12	185287-12S	1RA12	1 1/16-12	-12	103.9	4.09	63.2	2.49	15.5	0.61	19.8	0.78
1RA16FJA16	185287-16S	1RA16	1 5/16-12	-16	124.0	4.88	69.9	2.75	20.8	0.82	27.2	1.07

SAE 37° (JIC) swivel
90° elbow (short)

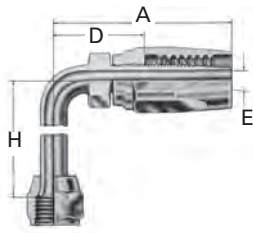

Assy part number	Nipple/nipple assy	New reusable socket	Thread size	Hose size	Dim A		Dim D		EØ		Dim H	
					mm	in	mm	in	mm	in	mm	in
1RA4FJB4	185264-4S	1RA4	7/16-20	-04	57.4	2.26	31.0	1.22	4.3	0.17	17.3	0.68
1RA6FJB6	185264-6S	1RA6	9/16-18	-06	67.3	2.65	38.6	1.52	7.9	0.31	21.6	0.85
1RA8FJB8	185264-8S	1RA8	3/4-16	-08	76.2	3.00	39.1	1.54	9.9	0.39	27.7	1.09
1RA12FJB12	185264-12S	1RA12	1 1/16-12	-12	102.9	4.05	62.2	2.45	15.5	0.61	46.2	1.82
1RA16FJB16	185264-16S	1RA16	1 5/16-12	-16	119.1	4.69	65.0	2.56	20.8	0.82	60.7	2.39

SAE 37° (JIC) swivel
90° elbow (long)

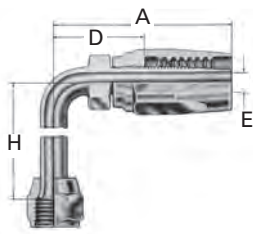

Assy part number	Nipple/nipple assy	New reusable socket	Thread size	Hose size	Dim A		Dim D		EØ		Dim H	
					mm	in	mm	in	mm	in	mm	in
1RA4FJC4	185263-4S	1RA4	7/16-20	-04	57.4	2.26	31.0	1.22	4.3	0.17	45.7	1.80
1RA6FJC6	185263-6S	1RA6	9/16-18	-06	67.3	2.65	38.6	1.52	7.9	0.31	55.4	2.18
1RA8FJC8	185263-8S	1RA8	3/4-16	-08	79.2	3.13	42.2	1.66	9.9	0.39	61.7	2.43
1RA12FJC12	185263-12S	1RA12	1 1/16-12	-12	102.9	4.05	62.2	2.45	15.5	0.61	94.7	3.73
1RA16FJC16	185263-16S	1RA16	1 5/16-12	-16	119.1	4.69	65.0	2.56	20.8	0.82	116.3	4.58

Field attachable

Braided hose - 1R series

Use with hose:
H180

ORS swivel

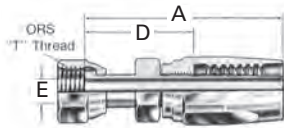

Assy part number	Nipple/nipple assy	New reusable socket	Thread size	Hose size	Dim A		Dim D		EØ	
					mm	in	mm	in	mm	in
1RA4FR4	FJ8732-0404S	1RA4	9/16-18	-04	66.5	2.62	40.1	1.58	4.1	0.16
1RA6FR6	FJ8732-0606S	1RA6	11/16-16	-06	74.9	2.95	46.2	1.82	6.6	0.26
1RA8FR8	FJ8732-0808S	1RA8	13/16-16	-08	85.9	3.38	48.5	1.91	9.1	0.36
1RA12FR12	FJ8732-1212S	1RA12	1 3/16 -12	-12	101.6	4.00	60.9	2.40	14.0	0.55
1RA16FR16	FJ8732-1616S	1RA16	1 7/16 -12	-16	117.9	4.64	63.8	2.51	19.8	0.78

ORS swivel 45° elbow

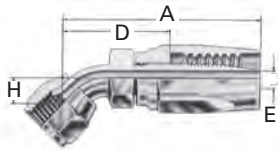

Assy part number	Nipple/nipple assy	New reusable socket	Thread size	Hose size	Dim A		Dim D		EØ		Dim H	
					mm	in	mm	in	mm	in	mm	in
1RA4FRA4	FJ8733-0404S	1RA4	9/16-18	-04	63.0	2.48	40.1	1.58	4.3	0.17	10.4	0.41
1RA6FRA6	FJ8733-0606S	1RA6	11/16-16	-06	70.9	2.79	46.2	1.82	6.6	0.26	10.9	0.43
1RA8FRA8	FJ8733-0808S	1RA8	13/16-16	-08	83.3	3.28	48.5	1.91	9.7	0.38	15.0	0.59
1RA12FRA12	FJ8733-1212S	1RA12	1 3/16 -12	-12	105.4	4.15	60.9	2.40	15.5	0.61	21.1	0.83
1RA16FRA16	FJ8733-1616S	1RA16	1 7/16 -12	-16	120.9	4.76	63.8	2.51	20.6	0.81	23.9	0.94

ORS swivel 90° elbow

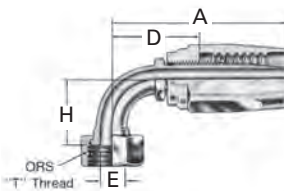

Assy part number	Nipple/nipple assy	New reusable socket	Thread size	Hose size	Dim A		Dim D		EØ		Dim H	
					mm	in	mm	in	mm	in	mm	in
1RA4FRB4	FJ8734-0404S	1RA4	9/16-18	-04	58.9	2.32	32.5	1.28	4.3	0.17	20.8	0.82
1RA6FRB6	FJ8734-0606S	1RA6	11/16-16	-06	67.3	2.65	38.6	1.52	6.6	0.26	22.9	0.90
1RA8FRB8	FJ8734-0808S	1RA8	13/16-16	-08	76.5	3.01	39.1	1.54	9.7	0.38	29.2	1.15
1RA12FRB12	FJ8734-1212S	1RA12	1 3/16 -12	-12	102.9	4.05	62.2	2.45	15.5	0.61	47.8	1.88
1RA16FRB16	FJ8734-1616S	1RA16	1 7/16 -12	-16	119.1	4.69	65.3	2.57	20.6	0.81	56.1	2.21

ORS swivel 90° elbow long drop

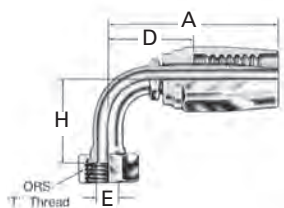

Assy part number	Nipple/nipple assy	New reusable socket	Thread size	Hose size	Dim A		Dim D		EØ		Dim H	
					mm	in	mm	in	mm	in	mm	in
1RA4FRC4	FJ8735-0404S	1RA4	9/16-18	-04	58.9	2.32	32.5	1.28	4.3	0.17	45.7	1.80
1RA6FRC6	FJ8735-0606S	1RA6	11/16-16	-06	70.4	2.77	41.7	1.64	6.6	0.26	54.1	2.13
1RA8FRC8	FJ8735-0808S	1RA8	13/16-16	-08	79.5	3.13	42.2	1.66	9.7	0.38	63.8	2.51
1RA12FRC12	FJ8735-1212S	1RA12	1 3/16 -12	-12	102.9	4.05	62.2	2.45	15.5	0.61	96.0	3.78
1RA16FRC16	FJ8735-1616S	1RA16	1 7/16 -12	-16	119.1	4.69	65.3	2.57	20.6	0.81	114.3	4.50

Use with hose:
H280

Field attachable

Braided hose - 2R series

Braided hose - 2R series

Male pipe

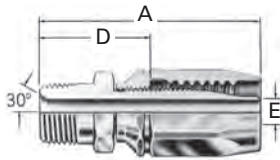

Assy part number	Nipple/nipple assy	New reusable socket	Thread size	Hose size	Dim A		Dim D		EØ	
					mm	in	mm	in	mm	in
2RA4MP4	4202-4-4S	2RA4	1/4-18	-04	63.5	2.50	33.8	1.33	4.3	0.17
2RA6MP6	4202-6-6S	2RA6	3/8-18	-06	69.9	2.75	35.8	1.41	7.9	0.31
2RA6MP8	4202-6-8S	2RA8	3/8-18	-08	72.1	2.84	33.3	1.31	9.9	0.39
2RA8MP8	4202-8-8S	2RA8	1/2-14	-08	74.5	3.09	40.1	1.58	9.9	0.39
2RA12MP12	4202-12-12S	2RA12	3/4-14	-12	91.7	3.61	44.2	1.74	15.5	0.61
2RA12MP16	4202-16-16S	2RA16	1-11 1/2	-16	111.8	4.40	59.7	2.35	20.8	0.82

SAE 37° (JIC) swivel

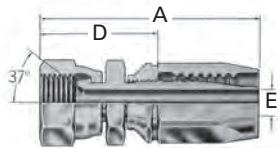

Assy part number	Nipple/nipple assy	New reusable socket	Thread size	Hose size	Dim A		Dim D		EØ	
					mm	in	mm	in	mm	in
2RA4FJ4	4103-4-4-4S	2RA4	7/16-20	-04	67.1	2.64	37.3	1.47	4.3	0.17
2RA6FJ6	4103-4-6-6S	2RA6	9/16-18	-06	75.7	2.98	41.7	1.64	7.9	0.31
2RA8FJ8	4103-4-8-8S	2RA8	3/4-16	-08	81.3	3.20	42.7	1.68	9.9	0.39
2RA12FJ12	4103-4-12S	2RA12	1 1/16-12	-12	98.0	3.86	50.5	1.99	15.5	0.61
2RA16FJ16	4103-4-16S	2RA16	1 5/16-12	-16	113.8	4.48	61.7	2.43	20.8	0.82

SAE 37° (JIC) male flare

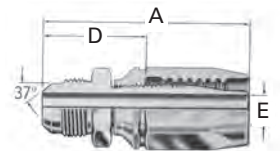

Assy part number	Nipple/nipple assy	New reusable socket	Thread size	Hose size	Dim A		Dim D		EØ	
					mm	in	mm	in	mm	in
2RA4MJ4	4203-4-4S	2RA4	7/16-20	-04	63.2	2.49	33.5	1.32	4.3	0.17
2RA6MJ6	4203-6-6S	2RA6	9/16-18	-06	69.9	2.75	35.8	1.41	7.9	0.31
2RA8MJ8	4203-8-8S	2RA8	3/4-16	-08	75.9	2.99	37.6	1.48	9.9	0.39
2RA12MJ12	4203-12S	2RA12	1 1/16-12	-12	94.5	3.72	47.0	1.85	15.5	0.61
2RA16MJ16	4203-16S	2RA16	1 5/16-12	-16	111.3	4.38	59.2	2.33	20.8	0.82

Field attachable

Braided hose - 2R series

Use with hose:

H280

SAE 37° (JIC) swivel 45° elbow

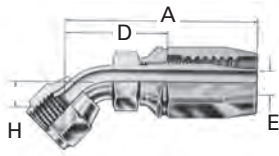

Assy part number	Nipple/nipple assy	New reusable socket	Thread size	Hose size	Dim A		Dim D		EØ		Dim H	
					mm	in	mm	in	mm	in	mm	in
2RA4FJA4	185287-4S	2RA4	7/16-20	-04	63.8	2.51	34.0	1.34	4.3	0.17	8.4	0.33
2RA6FJA6	185287-6S	2RA6	9/16-18	-06	71.6	2.82	37.6	1.48	7.9	0.31	9.9	0.39
2RA8FJA8	185287-8S	2RA8	3/4-16	-08	82.8	3.26	44.5	1.75	9.9	0.39	14.0	0.55
2RA12FJA12	185287-12S	2RA12	1 1/16-12	-12	105.4	4.15	57.9	2.28	15.5	0.61	19.8	0.78
2RA16FJA16	185287-16S	2RA16	1 5/16-12	-16	127.8	5.03	75.7	2.98	20.8	0.82	27.2	1.07

SAE 37° (JIC) swivel 90° elbow (short)

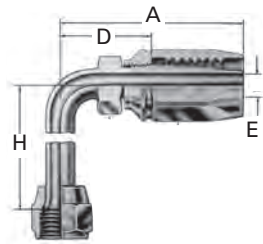

Assy part number	Nipple/nipple assy	New reusable socket	Thread size	Hose size	Dim A		Dim D		EØ		Dim H	
					mm	in	mm	in	mm	in	mm	in
2RA4FJB4	185264-4S	2RA4	7/16-20	-04	60.9	2.40	31.2	1.23	4.3	0.17	17.3	0.68
2RA6FJB6	185264-6S	2RA6	9/16-18	-06	69.1	2.72	35.1	1.38	7.9	0.31	21.6	0.85
2RA8FJB8	185264-8S	2RA8	3/4-16	-08	76.7	3.02	38.6	1.52	9.9	0.39	27.7	1.09
2RA12FJB12	185264-12S	2RA12	1 1/16-12	-12	104.4	4.11	56.9	2.24	15.5	0.61	46.2	1.82
2RA16FJB16	185264-16S	2RA16	1 5/16-12	-16	122.9	4.84	70.9	2.79	20.8	0.82	60.7	2.39

SAE 37° (JIC) swivel 90° elbow (long)

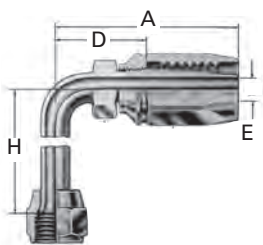

Assy part number	Nipple/nipple assy	New reusable socket	Thread size	Hose size	Dim A		Dim D		EØ		Dim H	
					mm	in	mm	in	mm	in	mm	in
2RA4FJC4	185263-4S	2RA4	7/16-20	-04	60.9	2.40	31.2	1.23	4.3	0.17	45.7	1.80
2RA6FJC6	185263-6S	2RA6	9/16-18	-06	69.1	2.72	35.1	1.38	7.9	0.31	55.4	2.18
2RA8FJC8	185263-8S	2RA8	3/4-16	-08	76.7	3.02	38.6	1.52	9.9	0.39	61.7	2.43
2RA12FJC12	185263-12S	2RA12	1 1/16-12	-12	104.4	4.11	56.9	2.24	15.5	0.61	94.7	3.73
2RA16FJC16	185263-16S	2RA16	1 5/16-12	-16	122.9	4.84	70.9	2.79	20.8	0.82	116.3	4.58

Use with hose:
H280

Field attachable

Braided hose - 2R series

ORS swivel

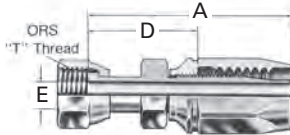

Assy part number	Nipple/nipple assy	New reusable socket	Thread size	Hose size	Dim A		Dim D		EØ	
					mm	in	mm	in	mm	in
2RA4FR4	FJ8732-0404S	2RA4	9/16-18	-04	70.1	2.76	40.3	1.59	4.1	0.16
2RA6FR6	FJ8732-0606S	2RA6	11/16-16	-06	77.0	3.03	42.9	1.69	6.6	0.26
2RA8FR8	FJ8732-0808S	2RA8	13/16-16	-08	86.4	3.40	48.0	1.89	9.1	0.36
2RA12FR12	FJ8732-1212S	2RA12	1 3/16-12	-12	103.1	4.06	59.9	2.36	14.0	0.55
2RA16FR16	FJ8732-1616S	2RA16	1 7/16-12	-16	121.7	4.79	69.6	2.74	19.8	0.78

ORS swivel 45° elbow

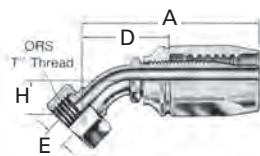

Assy part number	Nipple/nipple assy	New reusable socket	Thread size	Hose size	Dim A		Dim D		EØ		Dim H	
					mm	in	mm	in	mm	in	mm	in
2RA4FRA4	FJ8733-0404S	2RA4	9/16-18	-04	66.5	2.62	36.8	1.45	4.3	0.17	10.4	0.41
2RA6FRA6	FJ8733-0606S	2RA6	11/16-16	-06	72.9	2.87	38.9	1.53	6.6	0.26	10.9	0.43
2RA8FRA8	FJ8733-0808S	2RA8	13/16-16	-08	83.8	3.30	45.5	1.79	9.7	0.38	15.0	0.59
2RA12FRA12	FJ8733-1212S	2RA12	1 3/16-12	-12	106.9	4.21	59.4	2.34	15.5	0.61	21.1	0.83
2RA16FRA16	FJ8733-1616S	2RA16	1 7/16-12	-16	124.7	4.91	72.6	2.86	20.6	0.81	23.9	0.94

ORS swivel 90° elbow

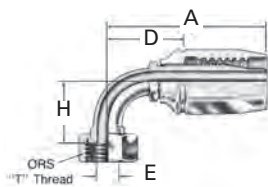

Assy part number	Nipple/nipple assy	New reusable socket	Thread size	Hose size	Dim A		Dim D		EØ		Dim H	
					mm	in	mm	in	mm	in	mm	in
2RA4FRB4	FJ8734-0404S	2RA4	9/16-18	-04	62.7	2.47	33.0	1.30	4.3	0.17	20.8	0.82
2RA6FRB6	FJ8734-0606S	2RA6	11/16-16	-06	69.1	2.72	35.1	1.38	6.6	0.26	22.9	0.90
2RA8FRB8	FJ8734-0808S	2RA8	13/16-16	-08	77.0	3.03	38.6	1.52	9.7	0.38	29.2	1.15
2RA12FRB12	FJ8734-1212S	2RA12	1 3/16-12	-12	104.4	4.11	56.9	2.24	15.5	0.61	47.8	1.88
2RA16FRB16	FJ8734-1616S	2RA16	1 7/16-12	-16	122.9	4.84	70.9	2.79	20.6	0.81	56.1	2.21

ORS swivel 90° elbow long drop

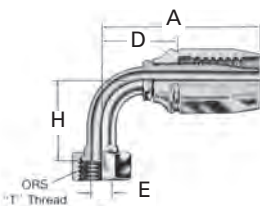

Assy part number	Nipple/nipple assy	New reusable socket	Thread size	Hose size	Dim A		Dim D		EØ		Dim H	
					mm	in	mm	in	mm	in	mm	in
2RA4FRC4	FJ8735-0404S	2RA4	9/16-18	-04	62.7	2.47	33.0	1.30	4.3	0.17	45.7	1.80
2RA6FRC6	FJ8735-0606S	2RA6	11/16-16	-06	69.1	2.72	35.1	1.38	6.6	0.26	54.1	2.13
2RA8FRC8	FJ8735-0808S	2RA8	13/16-16	-08	77.0	3.03	38.6	1.52	9.7	0.38	63.8	2.51
2RA12FRC12	FJ8735-1212S	2RA12	1 3/16-12	-12	104.4	4.11	56.9	2.24	15.5	0.61	96.0	3.78
2RA16FRC16	FJ8735-1616S	2RA16	1 7/16-12	-16	122.9	4.84	70.9	2.79	20.6	0.81	114.3	4.50

Field attachable

009 'B' series

009 'B' series

Ordering information: Order individually by catalog number.

 Refer to important safety information on pages A-2.

Application: Low pressure air, lube and oil lines.

Compatible hose: H009

Pressure: Determined by maximum working pressure for hose size. See pages A-24-25 for working pressure ratings for hose end configurations.

Material: CA360 brass

Advantages: Reusable and easy to assemble. An excellent fitting where low pressure applications exist and a clamp may get in the way. Good selection of configurations at a reasonable cost.

 **WARNING:** California Proposition 65, see page A-2.

Assembly instructions:

1. Lubricate* insert threads and I.D. of hose.
2. Push hose into socket until it bottoms.
3. Screw insert into socket until insert hex touches socket. When assembling swivel ends, leave 1/32" clearance between swivel nut and socket.

* Eaton Assembly Lubricant
222070-8 - 1 gallon plastic jug
222070 - 1 pint plastic squeeze bottle

Label set: FS-400

Note: Refer to current price list for availability of cataloged items. Configurations and dimensions subject to change without notice.

To determine the correct length of hose, subtract the cut-off factor for each end fitting from the overall length of assembly.

Swivel nuts are universal – both SAE 37° and 45° connections.

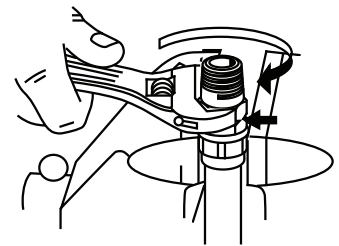
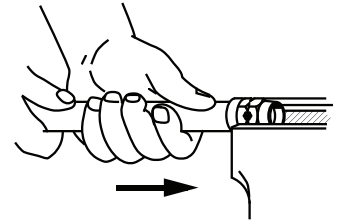

Male pipe rigid

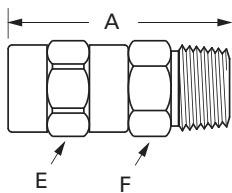

Hose I.D.	Pipe size	Part number	Thread size	A	Hose cut-off factor	Hole dia.	Hex E	Hex F
1/4	1/8	00904B-102	1/8-27	1.20	.75	.172	5/8	7/16
1/4	1/4	00904B-104	1/4-18	1.39	.94	.172	5/8	9/16

JIC 37° female swivel

(Exceptions noted)

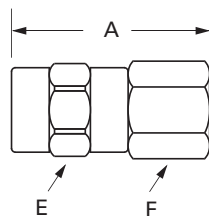

Hose I.D.	Pipe size	Part number	Thread size	A	Hose cut-off factor	Hole dia.	Hex E	Hex F
1/4	1/4	00904B-604	7/16-20	1.31	.81	.172	5/8	9/16

057 'B' series

⚠ WARNING

Hose can be cut or damaged if over-tightened.

Ordering information: Order individually by catalog number.

⚠ Refer to important safety information on pages A-2.

Application: Low pressure air, fuel and oil applications. Generally used for automotive, light truck, and small engine fuel lines.

Compatible hose: H057, H0105*, H0106*.

*H0105, H0106 and H115 for air applications only.

Pressure: Determined by maximum working pressure for hose size. See pages A-24-25 for working pressure ratings for hose end configurations.

Material: CA360 brass

⚠ WARNING: California Proposition 65, see page A-2.

Advantages: Easy to assemble — just push the fitting into the hose and clamp. Good selection of configurations at reasonable cost.

Assembly instructions:

1. Slide clamp over hose.
2. Insert barbed end of fitting into hose.
3. Locate band clamp in the middle of 057 'B' Series inserts and tighten.
4. Position wire clamp behind bump on 057 'B' Series insert with H057 hose only.

Note:

Refer to current price list for availability of cataloged items. Configurations and dimensions subject to change without notice.

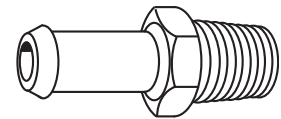
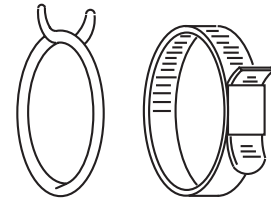

Male pipe rigid

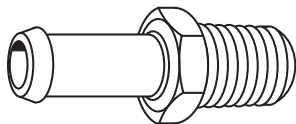

Hose I.D.	Pipe size	Part number
3/16	1/8	05703B-102
1/4	1/8	05704B-102
1/4	1/4	05704B-104
5/16	1/8	05705B-102
5/16	1/4	05705B-104
3/8	1/8	05706B-102
3/8	1/4	05706B-104
3/8	3/8	05706B-106
5/8	3/8	05710B-106
5/8	1/2	05710B-108
3/4	1/2	05712B-108

SAE 45° flare connector

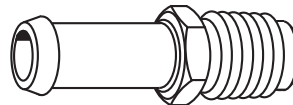

Hose I.D.	Tube size	Part number
3/8	5/16	05706B-305

Inverted male connector

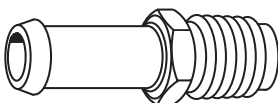

Hose I.D.	Tube size	Part number
5/16	1/4	05705B-1598
5/16	5/16	05705B-1560
5/16	3/8	05705B-1561
3/8	5/16	05706B-1568
3/8	3/8	05706B-1570

Male straight thread connector

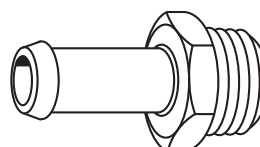

Hose I.D.	Thread size	Part number
3/8	9/16-24	05706B-1412
3/8	7/8-20	05706B-1413
3/8	5/8-20	05706B-1569

(Gasket included.)

Field attachable

057 'B' series

Male pipe rigid 90° elbow

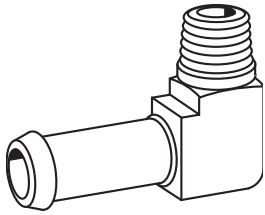

Hose I.D.	Pipe size	Part number
1/4	1/8	05704B-C02
5/16	1/8	05705B-C02
5/16	1/4	05705B-C04
3/8	1/8	05706B-C02
3/8	1/4	05706B-C04
3/8	3/8	05706B-C06
5/8	3/8	05710B-C06

Inverted male tee swivel

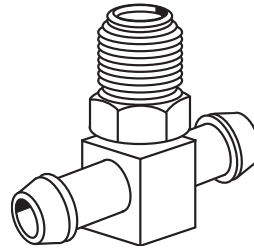

Hose I.D.	Tube size	Part number
3/8	5/16	05706B-1414#
3/8	3/8	05706B-1415#

Chrome plated.

Inverted male swivel 90° elbow

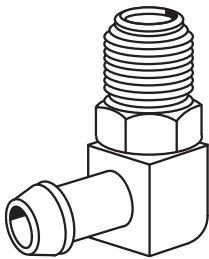

Hose I.D.	Tube size	Part number
1/4	1/4	05704B-B64
1/4	5/16	05704B-B65
5/16	5/16	05705B-B65
3/8	5/16	05706B-B65
3/8	3/8	05706B-B66
3/8	5/16	05706B-1416#
3/8	3/8	05706B-1417#

Chrome plated.

Wire hose clamp (For H057 hose only)



Hose I.D.	Part number
3/16, 1/4	1538
5/16	1539
3/8	1540

Note: Zinc-Plated carbon steel spring wire

WARNING: California Proposition 65, see page A-2.

To determine the correct length of hose, subtract the cut-off factor for each end fitting from the overall length of assembly.

Field attachable

100 'B' series Barb-Tite

100 'B' series Barb-Tite

CAUTION Sealing integrity may be damaged by the use of clamps.

Ordering information: Order individually by part number.

Refer to important safety information on pages A-2.

Application: Low pressure shop or service air lines. Often used for low pressure lube and oil lines.

Compatible hose: H100, H101, H201, H332, 35FH

Pressure: Determined by maximum working pressure for hose size. See pages A-24-25 for working pressure ratings for hose end configurations.

Material: CA360 brass

WARNING: California Proposition 65, see page A-2.

Advantages: Easy to assemble – just push the fitting into the hose. No clamps needed! Low cost and a wide selection of configurations and sizes.

Assembly instructions:

1. Lubricate* insert.
2. Hold hose at angle as shown and push on and up over first barb.
3. Continue to push straight on until hose is seated under protective plastic cap. (Keep hand back from hose end area so that hose can expand.)

* Eaton Assembly Lubricant
222070-8 - 1 gallon plastic jug
222070 - 1 pint plastic squeeze bottle

Disassembly instructions:

1. Split hose as shown. Do not cut completely through hose. Sealing edge of barb could be damaged.
2. Bend hose and remove with quick pull.

Assembly equipment: See pages L-26 and L-60 for optional Assembly Tools.

Label set: FS-500

Note: Refer to current price list for availability of cataloged items. Configurations and dimensions subject to change without notice.

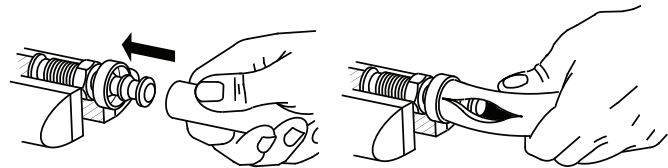

Male pipe rigid

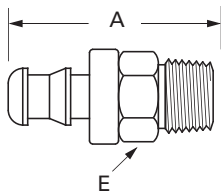

Hose I.D.	Pipe size	Part number	Thread size	A	Hose cut-off factor	Hole dia.	Hex E
1/4	1/8	10004B-102	1/8-27	1.29	.65	.172	7/16
1/4	1/4	10004B-104	1/4-18	1.52	.88	.172	9/16
5/16	1/8	10005B-102	1/8-27	1.36	.69	.234	1/2
5/16	1/4	10005B-104	1/4-18	1.57	.87	.234	9/16
3/8	1/8	10006B-102	1/8-27	1.46	.69	.297	1/2
3/8	1/4	10006B-104	1/4-18	1.65	.88	.297	9/16
3/8	3/8	10006B-106	3/8-18	1.65	.88	.297	11/16
1/2	3/8	10008B-106	3/8-18	1.85	.94	.391	11/16
1/2	1/2	10008B-108	1/2-14	2.10	1.19	.391	7/8
5/8	1/2	10010B-108	1/2-14	2.60	1.19	.484	7/8
3/4	3/4	10012B-112	3/4-14	2.66	1.25	.609	1-1/16
1	1	10016B-116	1-11 1/2	3.08	1.45	.85	1-3/8

SAE 45° flare male rigid

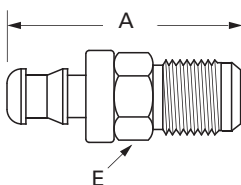

Hose I.D.	Tube size	Part number	Thread size	A	Hose cut-off factor	Hole dia.	Hex E
1/4	1/4	10004B-304	7/16-20	1.45	.81	.172	7/16
1/4	5/16	10004B-305	1/2-20	1.54	.94	.172	1/2
5/16	5/16	10005B-305	1/2-20	1.60	.94	.220	1/2
3/8	3/8	10006B-306	5/8-18	1.73	1.00	.297	5/8

Note: Drawings may differ from actual parts.

Field attachable

100 'B' series Barb-Tite

To determine the correct length of hose, subtract the cut-off factor for each end fitting from the overall length of assembly.

Inverted male swivel

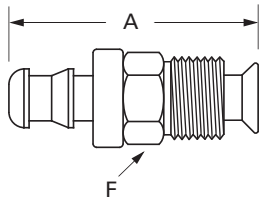

Hose I.D.	Tube size	Part number	Thread size	A	Hose cut-off factor	Hole dia.	Hex F
1/4	3/16	10004B-B03	3/8-24	1.39	1.13	.109	3/8
1/4	1/4	10004B-B04	7/16-24	1.42	1.13	.172	7/16
1/4	5/16	10004B-B05	1/2-20	1.52	1.19	.188	1/2
5/16	1/4	10005B-B04	7/16-24	1.81	1.11	.184	7/16
5/16	5/16	10005B-B05	1/2-20	1.60	.80	.234	1/2
5/16	3/8	10005B-B06	5/8-18	1.60	1.19	.234	5/8
3/8	5/16	10006B-B05	1/2-20	1.64	1.19	.234	1/2
3/8	3/8	10006B-B06	5/8-18	1.70	.97	.297	5/8
1/2	1/2	10008B-B08	3/4-18	2.24	1.25	.391	3/4

Female inverted rigid

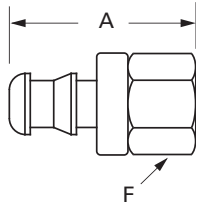

Hose I.D.	Tube size	Part number	Thread size	A	Hose cut-off factor	Hole dia.	Hex F
1/4	3/16	10004B-A03	3/8-24	1.12	.48	.172	1/2
1/4	1/4	10004B-A04	7/16-24	1.14	.50	.172	9/16
1/4	5/16	10004B-A05	1/2-20	1.18	.56	.172	5/8
5/16	5/16	10005B-A05	1/2-20	1.25	.56	.220	5/8
3/8	5/16	10006B-A05	1/2-20	1.32	.55	.297	5/8
3/8	3/8	10006B-A06	5/8-18	1.35	.63	.297	3/4
1/2	1/2	10008B-A08	3/4-18	1.73	.75	.391	7/8

Female pipe swivel

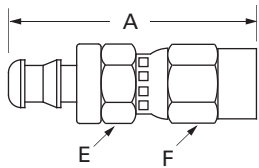

Hose I.D.	Tube size	Part number	Thread size	A	Hose cut-off factor	Hole dia.	Hex E	Hex F
1/4	1/4	10004B-254	1/4-18	2.42	1.81	.172	3/4	5/8
3/8	3/8	10006B-256	3/8-18	2.77	2.00	.297	7/8	11/16
1/2	1/2	10008B-258	1/2-14	3.29	2.38	.391	1-1/8	7/8

JIC 37° female swivel

(Refer to Footnotes)

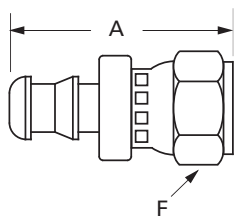

Hose I.D.	Tube size	Part number	Thread size	A	Hose cut-off factor	Hole dia.	Hex F
1/4	1/4	10004B-604 ^a	7/16-20	1.38	.74	.172	9/16
1/4	5/16	10004B-605 ^a	1/2-20	1.42	.81	.172	5/8
5/16	5/16	10005B-605 ^a	1/2-20	1.54	.83	.234	11/16
3/8	5/16	10006B-605 ^a	1/2-20	1.60	.88	.297	11/16
3/8	3/8	10006B-606	9/16-18	1.66	.88	.297	11/16
1/2	1/2	10008B-608 ^a	3/4-16	2.06	1.06	.391	7/8
5/8	5/8	10010B-610 ^a	7/8-14	2.67	1.19	.484	1
3/4	5/8	10012B-610 ^a	7/8-14	2.69	1.25	.511	1
3/4	3/4	10012B-612	1-1/16-12	2.69	1.19	.609	1-1/4

^a Swivel nuts are universal — both SAE 37° and 45° connections.

WARNING: California Proposition 65, see page A-2.

Note: Drawings may differ from actual parts.

To determine the correct length of hose, subtract the cut-off factor for each end fitting from the overall length of assembly.

Field attachable

100 'B' series Barb-Tite

SAE 45° flare female swivel

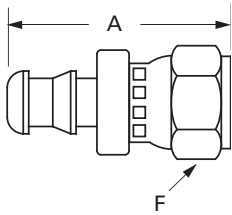

Hose I.D.	Tube size	Part number	Thread size	A	Hose cut-off factor	Hole dia.	Hex F
3/8	3/8	10006B-406	5/8-18	1.73	.88	.297	3/4
3/4	3/4	10012B-412	1-1/16-14	2.66	1.25	.609	1-1/4

Straight tube rigid

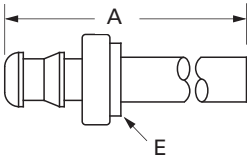

Hose I.D.	Tube size	Part number	Thread size	A	Hose cut-off factor	Hole dia.	Hex F
1/4	3/16	10004B-X03	.188	1.53	0.78	.172	13/32
1/4	1/4	10004B-X04	.250	1.55	0.80	.172	13/32
1/4	5/16	10004B-X05	.312	1.65	0.90	.172	13/32
5/16	5/16	10005B-X05	.312	2.02	1.21	.228	7/16
3/8	3/8	10006B-X06	.375	2.13	1.26	.297	1/2

Hose mender

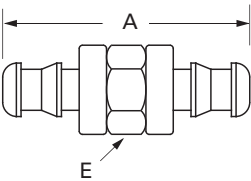

Hose I.D.	Part number	A	Hose cut-off factor	Hole dia.	Hex E
1/4	10004B-Y04	1.86	.38	.172	1/2
5/16	10005B-Y05	2.04	.44	.234	9/16
3/8	10006B-Y06	2.14	.44	.297	5/8
1/2	10008B-Y08	2.46	.50	.391	3/4
5/8	10010B-Y10	3.61	.53	.48	1-1/8
3/4	10012B-Y12	3.63	.60	.61	1-1/4

Male pipe rigid 90° elbow

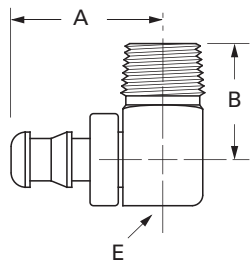

Hose I.D.	Pipe size	Part number	Thread size	A	B	Hose cut-off factor	Hole dia.	Square E
5/16	1/8	10005B-C02	1/8-27	1.11	.94	.31	.228	1/2
5/16	1/4	10005B-C04	1/4-18	1.18	.94	.38	.228	9/16
3/8	1/8	10006B-C02	1/8-27	1.17	.94	.38	.297	1/2
3/8	1/4	10006B-C04	1/4-18	1.24	.94	.38	.297	9/16

WARNING: California Proposition 65, see page A-2.

Note: Drawings may differ from actual parts.

Field attachable

105 'B' series Barb-Tite

To determine the correct length of hose, subtract the cut-off factor for each end fitting from the overall length of assembly.

105 'B' series Barb-Tite

⚠ WARNING

Hose can be damaged if over-tightened.

Ordering information: Order individually by part number.

⚠ Refer to important safety information on pages A-2.

Application: Low pressure shop or service air lines.

Compatible hose: H0105 and H0106

⚠ **WARNING:** California Proposition 65, see page A-2.

Pressure: Determined by maximum working pressure for hose size. See pages A-24-25 for working pressure ratings for hose end configurations.

Material: CA360 brass

Advantages: Easy to assemble—just push the fitting into the hose and clamp. Low cost and a good selection of sizes.

Note:

Refer to current price list for availability of cataloged items. Configurations and dimensions subject to change without notice.

Assembly instructions:

1. Slide clamp over hose.
2. Insert barbed end of fitting into hose.
3. Locate clamp in middle of insert and tighten. Use 6203/6204 Series clamps only. See page K-29.

Label set: FS-500

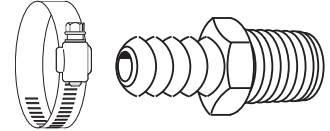

Male pipe (PTF short)

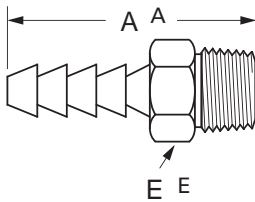

Hose I.D.	Pipe size	Part number	A	Hex F	Number of barbs
1/8	1/8	10502B-102	1.00	7/16	4
3/16	1/8	10503B-102	1.16	7/16	3
3/16	1/4	10503B-104	1.43	9/16	3
1/4	1/8	10504B-102	1.54	7/16	4
1/4	1/4	10504B-104	1.61	9/16	4
1/4	3/8	10504B-106	1.72	11/16	4
5/16	1/8	10505B-102	1.60	7/16	4
5/16	1/4	10505B-104	1.77	9/16	4
3/8	1/8	10506B-102	1.53	7/16	4
3/8	1/4	10506B-104	1.70	9/16	4
3/8	3/8	10506B-106	1.72	11/16	4
3/8	1/2	10506B-108	1.95	7/8	4
1/2	1/4	10508B-104	1.71	9/16	4
1/2	3/8	10508B-106	1.72	11/16	4
1/2	1/2	10508B-108	1.94	7/8	4
1/2	3/4	10508B-112	1.95	1-1/8	4
5/8	3/8	10510B-106	1.72	3/4	4
5/8	1/2	10510B-108	1.95	7/8	4
5/8	3/4	10510B-112	1.91	1-1/8	4
3/4	1/2	10512B-108	1.86	7/8	4
3/4	3/4	10512B-112	1.92	1-1/8	4

Female pipe (NPTF)

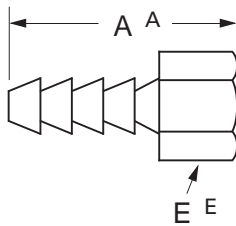

Hose I.D.	Pipe size	Part number	A	Hex F	Number of barbs
1/8	1/8	10502B-202	.97	9/16	4
3/16	1/8	10503B-202	1.19	9/16	3
1/4	1/8	10504B-202	1.47	9/16	4
1/4	1/4	10504B-204	1.58	11/16	4
5/16	1/8	10505B-202	1.47	9/16	4
5/16	1/4	10505B-204	1.58	11/16	4
3/8	1/8	10506B-202	1.47	9/16	4
3/8	1/4	10506B-204	1.58	11/16	4
3/8	3/8	10506B-206	1.64	13/16	4
1/2	1/4	10508B-204	1.58	11/16	4
1/2	3/8	10508B-206	1.64	13/16	4
1/2	1/2	10508B-208	1.86	1	4

Note: Drawings may differ from actual parts.

To determine the correct length of hose, subtract the cut-off factor for each end fitting from the overall length of assembly.

Field attachable

338 'B' series

338 'B' series

(Parts are stamped with DOT)

Ordering information: Order individually by part number. Complete air brake hose assemblies can be found in the Ready-Made Hose Assemblies section of this catalog. Refer to page K-16.

! Refer to important safety information on pages A-2.

Application:
Air brake hose lines.

Compatible hose: EC038

! **WARNING:** California Proposition 65, see page A-2.

Pressure: Determined by maximum working pressure for hose size. See pages A-24-25 for working pressure ratings for hose end configurations.

Material: CA360 brass

Advantages: Can be used for nearly any air brake line. Easy to assemble with a good selection of hose end configurations. Brass material offers excellent resistance against corrosion.

Assembly instructions:

1. Slide nut and sleeve onto hose. Make sure bevel edge of sleeve faces out toward fitting.
2. Push hose into fitting until it bottoms.
3. Screw nut until contact is made with body hex.

Label set: FS-800

Note:

Refer to current price list for availability of cataloged items. Configurations and dimensions subject to change without notice.

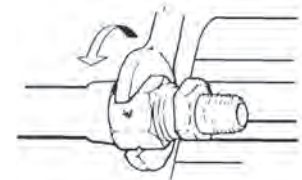
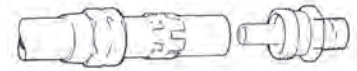

Male connector

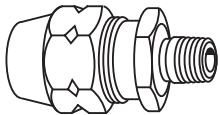

Hose I.D.	Pipe size	Part number	Overall length	Hose cut-off factor
3/8	1/4	33806B-Y24	2.26	.69
3/8	3/8	33806B-Y26	2.35	.81
3/8	1/2	33806B-Y28	2.45	.94
1/2	3/8	33808B-Y26	2.24	.75
1/2	1/2	33808B-Y28	2.40	.94

Male connector with spring guard

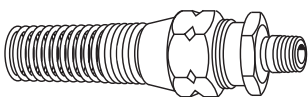

Hose I.D.	Pipe size	Part number	Overall length	Hose cut-off factor
3/8	1/4	33806B-Y34	4.72	.75
3/8	3/8	33806B-Y36	4.78	.81
3/8	1/2	33806B-Y38	4.88	.94
1/2	3/8	33808B-Y36	5.12	.75
1/2	1/2	33808B-Y38	4.88	.94

Female connector

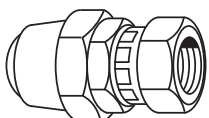

Hose I.D.	ABS thread size	Part number	Overall length	Hose cut-off factor
3/8	3/4-20	33806B-Y76	2.40	.88
1/2	7/8-20	33808B-Y78	2.37	.88

(Steel nut)

Field attachable

338 'B' series

To determine the correct length of hose, subtract the cut-off factor for each end fitting from the overall length of assembly.

Female connector with adapter

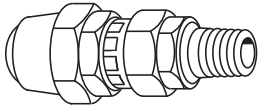

Hose I.D.	Pipe size	Part number	ABS thread size	Overall length	Hose cut-off factor
3/8	1/4	33806B-Y84	3/4-20	3.33	1.81
3/8	3/8	33806B-Y86	3/4-20	3.33	1.75
1/2	3/8	33808B-Y86	7/8-20	3.30	1.75

(Steel nut)

Hose mender

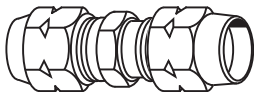

Hose I.D.	Part number	Overall length
3/8	33806B-Y06	3.28
1/2	33808B-Y08	3.25

Hose mender (Body only)

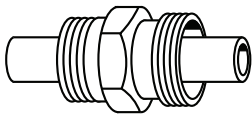

Hose I.D.	Part number	Overall length
3/8	33806-E	2.55

Adapter

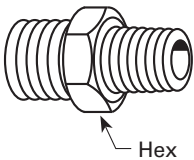

ABS thread size	Pipe size	Part number	Overall length	ABS thread size	Hex
3/8	1/4	1390x6	1.18	3/4-20	3/4
3/8	3/8	1390x6x6	1.18	3/4-20	3/4
3/8	1/2	1390x6x8	1.37	3/4-20	7/8
1/2	3/8	1390x8	1.18	7/8-20	7/8
1/2	1/2	1390x8x8	1.37	7/8-20	7/8

Spring guard

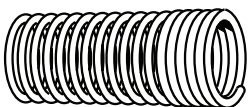

Hose I.D.	Part number
3/8	33806-C
1/2	33808-C

(Steel nut)

WARNING: California Proposition 65, see page A-2.

Insert
(Body only)

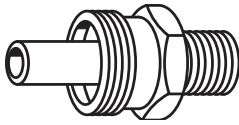

Hose I.D.	Pipe size	Part number	Hole dia.
3/8	1/4	1391x6	.281
3/8	3/8	1391x6x6	.281
3/8	1/2	1391x6x8	.281
1/2	3/8	1391x8	.390
1/2	1/2	1391x8x8	.390

Sleeve

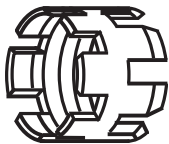

Hose I.D.	Part number
3/8	33806-A
1/2	33808-A

Nut

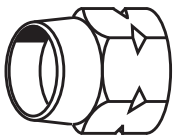

Hose I.D.	Part number
3/8	33806-B
1/2	33808-B

Nut For spring guard

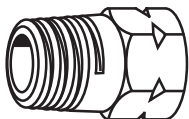

Hose I.D.	Part number
3/8	33806-D
1/2	33808-D

WARNING: California Proposition 65, see page A-2.

Field attachable

069 'D' series

To determine the correct length of hose, subtract the cut-off factor for each end fitting from the overall length of assembly.

069 'D' series

Ordering information: Order individually by part number. For mandrel, see page L-25.

⚠ Refer to important safety information on pages A-2.

Application: Medium pressure and high temperature hose lines for a variety of applications including truck, industrial, and small engine where temperature may be a problem.

Compatible hose: H069, H166, H169, H229, H366.

Pressure: Determined by hose burst pressure. See pages A-24-25 for working pressure ratings for hose end configurations.

Material: AISI/SAE 12L14 carbon steel

Plating: Zinc; clear trivalent chromate

Advantages: Very popular in heavy-duty truck markets. Can be used with a variety of hoses allowing for a diverse number of applications.

Assembly instructions:

1. Lubricate* mandrel, insert threads and I.D. of hose.
2. Screw hose into socket (left-hand thread) until hose bottoms. Back out 1/4 turn.
3. Place insert on mandrel. Screw insert into socket. When assembling swivel ends, leave 1/32" clearance between swivel nut and socket.

* Eaton Assembly Lubricant
222070-8 - 1 gallon plastic jug
222070 - 1 pint plastic squeeze bottle

Label set: FS-600

Note:

Refer to current price list for availability of cataloged items. Configurations and dimensions subject to change without notice.

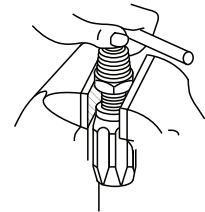
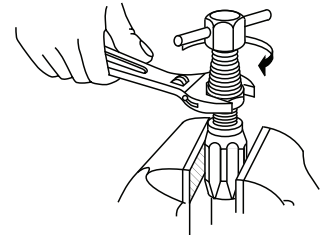
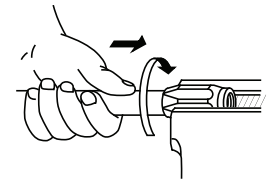

Male pipe rigid

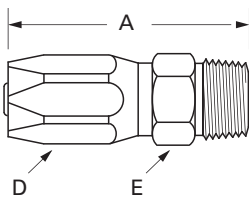

Hose I.D.	Pipe size	Part number	Thread size	A	Hose cut-off factor	Hole dia.	Hex D	Hex E
3/16	1/8	06904D-102	1/8-27	1.72	1.00	.17	5/8	7/16
3/16	1/4	06904D-104	1/4-18	1.90	1.19	.17	5/8	9/16
1/4	1/4	06905D-104	1/4-18	1.96	1.18	.25	11/16	9/16
5/16	1/4	06906D-104	1/4-18	2.10	1.25	.30	13/16	5/8
13/32	3/8	06908D-106	3/8-18	2.48	1.38	.39	15/16	11/16
13/32	1/2	06908D-108	1/2-14	2.73	1.58	.39	15/16	7/8
1/2	1/2	06910D-108	1/2-14	2.88	1.59	.48	1-1/8	7/8
5/8	3/4	06912D-112	3/4-14	3.24	1.67	.61	1-1/4	1-1/16
7/8	3/4	06916D-112	3/4-14	2.80	1.53	.72	1-7/16	1-1/8
7/8	1	06916D-116	1-11-1/2	3.00	1.81	.81	1-7/16	1-3/8
1-1/8	1-1/4	06920D-120	1-1/4-11-1/2	3.18	1.88	1.05	1-3/4	1-11/16
1-3/8	1-1/2	06924D-124	1-1/2-11-1/2	3.48	2.03	1.28	1-15/16	2
1-13/16	2	06932D-132	2-11-1/2	4.06	2.21	1.75	2-1/2	2-1/2
2-3/8	2-1/2	06940T-140*	2-1/2-8	5.03	3.13	2.20	3-1/8	3

* Brass construction

⚠ WARNING: California Proposition 65, see page A-2.

To determine the correct length of hose, subtract the cut-off factor for each end fitting from the overall length of assembly.

JIC 37° female swivel

(Exceptions noted for 45° flare – refer to footnotes)

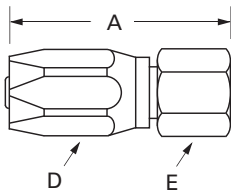

Hose I.D.	Tube size	Part number	Thread size	A	Hose cut-off factor	Hole dia.	Hex D	Hex E
3/16	1/4	06904D-604 ^a	7/16-20	1.74	1.06	.17	5/8	9/16
1/4	5/16	06905D-605 ^a	1/2-20	1.90	1.19	.24	11/16	5/8
5/16	3/8	06906D-606	9/16-18	2.05	1.15	.30	13/16	11/16
13/32	1/2	06908D-608 ^a	3/4-16	2.52	1.38	.39	15/16	7/8
1/2	5/8	06910D-610 ^a	7/8-14	2.79	1.56	.49	1-1/8	1
5/8	3/4	06912D-612	1-1/16-12	3.15	1.63	.61	1-1/4	1-1/4
7/8	1	06916D-616	1-5/16-12	2.81	1.63	.82	1-7/16	1-1/2
1-1/8	1-1/4	06920D-620	1-5/8-12	3.00	1.64	1.05	1-3/4	2
1-3/8	1-1/2	06924D-624	1-7/8-12	3.28	1.88	1.28	1-15/16	2-1/4
1-13/16	2	06932D-632	2-1/2-12	4.02	2.18	1.75	2-1/2	2-7/8
2-3/8	2-1/2	06940T-640*	3-12	4.16	2.25	2.22	3-1/8	3-3/8

*Brass construction.

^a Swivel nuts are universal – both SAE 37° and 45° connections.

⚠ WARNING: California Proposition 65, see page A-2.

SAE 45° female swivel

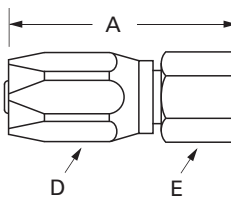

Hose I.D.	Tube size	Part number	Thread size	A	Hose cut-off factor	Hole dia.	Hex D	Hex E
5/16	3/8	06906D-406	5/8-18	2.05	1.19	.29	13/16	3/4
5/8	3/4	06912D-412	1-1/16-14	3.02	1.44	.61	1-1/4	1-1/4

30° Flare female swivel

(PTT Thread for diesel applications)

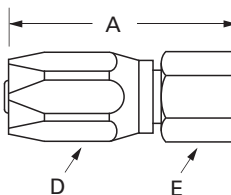

Hose I.D.	Tube size	Part number	Thread size	A	Hose cut-off factor	Hole dia.	Hex D	Hex E
7/8	1	06916D-X26	1-5/16-14	2.60	1.33	.81	1-7/16	1-1/2

(See page J-128 for PTT thread adapter.)

Field attachable

213 'N' series

213 'N' series

Ordering information: Order individually by part number.

 Refer to important safety information on pages A-2.

Application: Medium pressure and high temperature hose lines for a variety of applications including truck, industrial, and small engines where high temperatures exist.

Compatible hose: H213

Pressure: Determined by maximum working pressure for hose size and hose end configuration whichever is lesser. See pages A-24-25 for working pressure ratings for hose end configurations.

Material: AISI/SAE 12L14 carbon steel

Plating: Zinc; clear trivalent chromate

Advantages: Very popular in heavy-duty truck markets. Good selection of Fittings. Non-mandrel assembly.

Assembly instructions:

1. Lubricate* insert threads and I.D. of hose.
2. Screw hose into socket (left-hand thread) until hose bottoms. Back out 1/4 turn.
3. Screw insert into socket until insert touches socket.

* Eaton Assembly Lubricant
222070-8 - 1 gallon plastic jug
222070 - 1 pint plastic squeeze bottle

Note:

Refer to current price list for availability of cataloged items. Configurations and dimensions subject to change without notice.

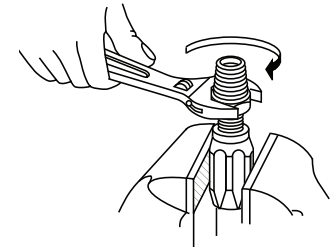
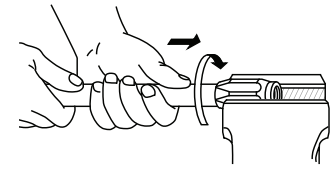

To determine the correct length of hose, subtract the cut-off factor for each end fitting from the overall length of assembly.

Male pipe rigid

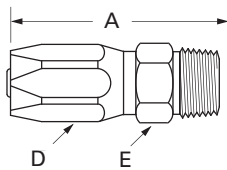

Hose I.D.	Pipe size	Part number	Thread size	A	Hose cut-off factor	Hole dia.	Hex D	Hex F
3/16	1/8	21304N-102	1/8-27	1.59	.94	.12	9/16	7/16
3/16	1/4	21304N-104	1/4-18	1.78	1.13	.12	9/16	9/16
1/4	1/4	21305N-104	1/4-18	1.80	1.06	.17	5/8	9/16
5/16	3/8	21306N-106	3/8-18	1.96	1.19	.23	3/4	11/16
13/32	1/2	21308N-108	1/2-14	2.36	1.44	.33	7/8	7/8
1/2	1/2	21310N-108	1/2-14	2.45	1.44	.42	1	7/8
5/8	3/4	21312N-112	3/4-14	2.56	1.50	.55	1-1/8	1-1/16
7/8	1	21316N-116	1-11-1/2	2.71	1.69	.80	1-3/8	1-3/8

Inverted male swivel straight

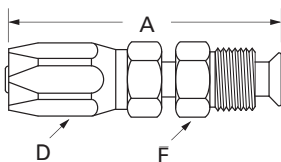

Hose I.D.	Tube size	Part number	Thread size	A	Hose cut-off factor	Hole dia.	Hex D	Hex F
3/16	1/4	21304N-B04	7/16-24	2.43	1.69	.15	9/16	7/16
1/4	5/16	21305N-B05	1/2-20	2.47	1.75	.21	5/8	1/2
5/16	1/4	21306N-B04	7/16-24	2.50	1.63	.15	3/4	7/16
5/16	5/16	21306N-B05	1/2-20	2.57	1.75	.21	3/4	1/2
5/16	3/8	21306N-B06	5/8-18	2.74	1.88	.25	3/4	5/8
13/32	1/2	21308N-B08	3/4-18	3.26	2.25	.33	7/8	3/4

To determine the correct length of hose, subtract the cut-off factor for each end fitting from the overall length of assembly.

JIC 37° female swivel

(Exceptions noted for 45° flare – refer to footnotes)

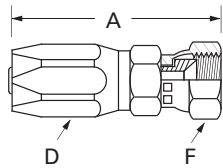

Hose I.D.	Tube size	Part number	Thread size	A	Hose cut-off factor	Hole dia.	Hex D	Hex F
3/16	1/4	21304N-604 ^a	7/16-20	1.92	1.25	.15	9/16	9/16
1/4	5/16	21305N-605 ^a	1/2-20	2.01	1.25	.20	5/8	5/8
5/16	3/8	21306N-606	9/16-18	2.20	1.38	.26	3/4	11/16
13/32	1/2	21308N-608 ^a	3/4-16	2.49	1.50	.36	7/8	7/8
1/2	5/8	21310N-610 ^a	7/8-14	2.69	1.63	.45	1	1
5/8	3/4	21312N-612	1-1/16-12	2.91	1.75	.57	1-1/8	1-1/4
7/8	1	21316N-616	1-5/16-12	2.95	1.88	.82	1-3/8	1-1/2

^a Swivel nuts are universal – both SAE 37° and 45° connections.

SAE 45° female swivel

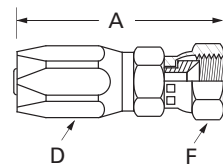

Hose I.D.	Tube size	Part number	Thread size	A	Hose cut-off factor	Hole dia.	Hex D	Hex F
5/16	3/8	21306N-406	5/8-18	2.14	1.38	.26	3/4	3/4
5/8	3/4	21312N-412	1-1/16-14	2.85	1.75	.57	1-1/8	1-1/4

30° Flare female swivel

(PTT thread For diesel applications)

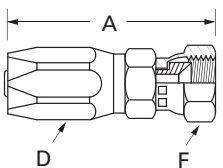

Hose I.D.	Tube size	Part number	Thread size	A	Hose cut-off factor	Hole dia.	Hex D	Hex F
7/8	1	21316N-X26	1-5/16-14	2.78	1.69	.81	1-3/8	1-1/2

(See page J-128 for PTT thread adapter.)

**Inverted male swivel
45° tube elbow**

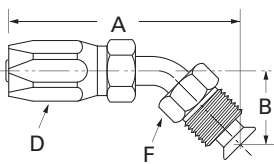

Hose I.D.	Tube size	Part number	Thread size	A	B	Hose cut-off factor	Hole dia.	Hex D	Hex F
3/16	1/4	21304N-E44	7/16-24	2.91	.93	2.19	.15	9/16	7/16
1/4	5/16	21305N-E45	1/2-20	3.30	1.14	2.63	.21	5/8	1/2
5/16	1/4	21306N-E44	7/16-24	3.10	.93	2.25	.15	3/4	7/16
5/16	5/16	21306N-E45	1/2-20	3.40	1.14	2.63	.21	3/4	1/2
5/16	3/8	21306N-E46	5/8-18	3.26	.94	2.38	.25	3/4	5/8
13/32	1/2	21308N-E48	3/4-18	3.70	.94	2.69	.33	7/8	3/4

Field attachable

213 'N' series

To determine the correct length of hose, subtract the cut-off factor for each end fitting from the overall length of assembly.

SAE 37° female swivel 45° tube elbow

(Exceptions noted for 45° flare – refer to footnotes)

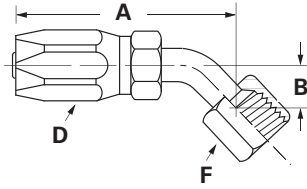

Hose I.D.	Tube size	Part number	Thread size	A	B	Hose cut-off factor	Hole dia.	Hex D	Hex F
3/16	1/4	21304N-684 ^a	7/16-20	2.34	.33	1.63	.15	9/16	9/16
1/4	5/16	21305N-685 ^a	1/2-20	2.44	.36	1.69	.21	5/8	5/8
5/16	3/8	21306N-686	9/16-18	2.61	.39	1.75	.25	3/4	5/8
13/32	1/2	21308N-688 ^a	3/4-16	3.13	.55	2.13	.33	7/8	7/8

^a Swivel nuts are universal – both SAE 37° and 45° connections.

SAE 45° female swivel 45° tube elbow

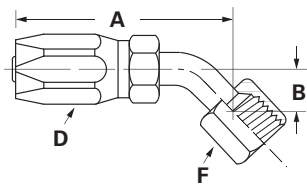

Hose I.D.	Tube size	Part number	Thread size	A	B	Hose cut-off factor	Hole dia.	Hex D	Hex F
5/16	3/8	21306N-486	5/8-18	2.85	.39	1.81	.25	3/4	3/4

Inverted male swivel 90° tube elbow

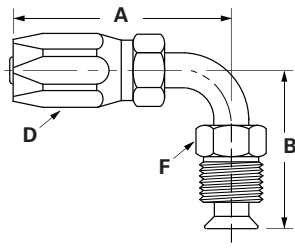

Hose I.D.	Tube size	Part number	Thread size	A	B	Hose cut-off factor	Hole dia.	Hex D	Hex F
3/16	1/4	21304N-E04	7/16-24	1.69	1.36	1.50	.13	9/16	7/16
1/4	5/16	21305N-E05	1/2-20	2.49	1.61	1.75	.17	5/8	1/2
5/16	1/4	21306N-E04	7/16-24	2.58	1.65	1.75	.15	3/4	7/16
5/16	5/16	21306N-E05	1/2-20	2.50	1.61	1.63	.21	3/4	1/2
5/16	3/8	21306N-E06	5/8-18	2.82	1.97	2.00	.24	3/4	5/8
13/32	1/2	21308N-E08	3/4-18	2.78	1.69	1.81	.33	7/8	3/4

JIC 37° female swivel 90° tube elbow

(Exceptions noted for 45° flare – refer to footnotes)

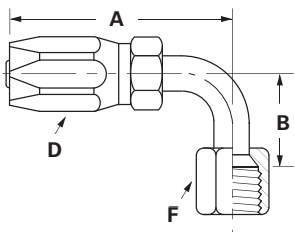

Hose I.D.	Tube size	Part number	Thread size	A	B	Hose cut-off factor	Hole dia.	Hex D	Hex F
3/16	1/4	21304N-664 ^a	7/16-20	2.16	.68	1.44	.13	9/16	9/16
1/4	5/16	21305N-665 ^a	1/2-20	2.46	.77	1.75	.17	5/8	5/8
5/16	3/8	21306N-666	9/16-18	2.61	.85	1.81	.24	3/4	11/16
13/32	1/2	21308N-668 ^a	3/4-16	2.91	1.09	1.94	.33	7/8	7/8

^a Swivel nuts are universal – both SAE 37° and 45° connections.

SAE 45° female swivel 90° tube elbow

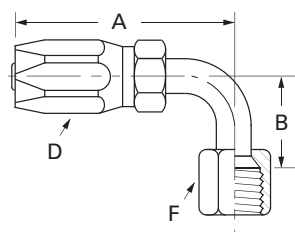

Hose I.D.	Tube size	Part number	Thread size	A	B	Hose cut-off factor	Hole dia.	Hex D	Hex F
5/16	3/8	21306N-466	5/8-18	2.48	.85	1.63	.24	3/4	3/4

To determine the correct length of hose, subtract the cut-off factor for each end fitting from the overall length of assembly.

Field attachable

247 'N' series

247 'N' series

Ordering information: Order individually by catalog number.

! Refer to important safety information on pages A-2.

Application: Medium pressure and high temperature hose lines for a variety of applications including truck, industrial, and small engine where temperature may be a problem.

Compatible hose: H059, H069, H166, H169, H229, H366, H569

Pressure: Determined by maximum working pressure for hose size and hose end configuration whichever is lesser. See pages A-24-25 for working pressure ratings for hose end configurations.

Material: AISI/SAE 12L14 carbon steel

Plating: Zinc; clear trivalent chromate

Advantages: Very popular in heavy-duty truck markets. Good selection of fittings. Compatible with a wide variety of hose types allowing for a diverse number of applications. Non-mandrel assembly.

Assembly instructions:

1. Lubricate* insert threads and I.D. of hose.
2. Screw hose into socket (left-hand thread) until hose bottoms. Back out 1/4 turn.
3. Screw insert into socket until insert touches socket.

* Eaton Assembly Lubricant
222070-8 - 1 gallon plastic jug
222070 - 1 pint plastic squeeze bottle

Label set: FS-600

Note:

Refer to current price list for availability of cataloged items. Configurations and dimensions subject to change without notice.

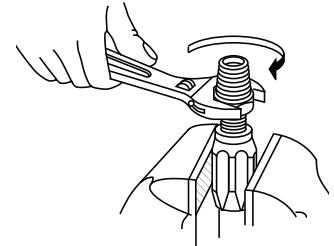
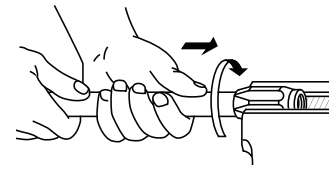

Male pipe rigid

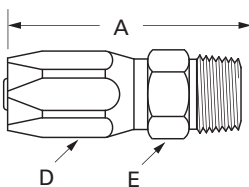

Hose I.D.	Pipe size	Part number	Thread size	A	Hose cut-off factor	Hole dia.	Hex D	Hex E
3/16	1/8	24704N-102	1/8-27	1.71	1.00	.12	5/8	7/16
3/16	1/4	24704N-104	1/4-18	1.87	1.12	.12	5/8	9/16
1/4	1/4	24705N-104	1/4-18	1.96	1.25	.18	11/16	9/16
5/16	1/4	24706N-104	1/4-18	2.08	1.25	.25	13/16	9/16
5/16	3/8	24706N-106	3/8-18	2.11	1.25	.25	13/16	11/16
13/32	3/8	24708N-106	3/8-18	2.48	1.33	.36	15/16	11/16
13/32	1/2	24708N-108	1/2-14	2.73	1.58	.36	15/16	7/8
1/2	1/2	24710N-108	1/2-14	2.88	1.63	.45	1-1/8	7/8
1/2	3/4	24710N-112	3/4-14	2.94	1.69	.45	1-1/8	1-1/8
5/8	3/4	24712N-112	3/4-14	3.24	1.67	.55	1-1/4	1-1/4

JIC 37° male rigid

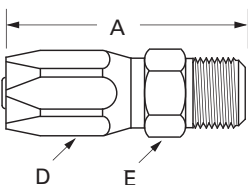

Hose I.D.	Tube size	Part number	Thread size	A	Hose cut-off factor	Hole dia.	Hex D	Hex E
3/16	1/4	24704N-504	7/16-20	1.85	1.10	.12	5/8	1/2
1/4	5/16	24705N-505	1/2-20	2.01	1.19	.18	11/16	9/16
5/16	3/8	24706N-506	9/16-18	2.13	1.25	.25	13/16	5/8
13/32	1/2	24708N-508	3/4-16	2.64	1.56	.36	15/16	13/16
1/2	5/8	24710N-510	7/8-14	2.92	1.69	.45	1-1/8	15/16
5/8	3/4	24712N-512	1-1/16-12	3.32	1.81	.55	1-1/4	1-1/8
7/8	1	24716N-516	1-5/16-12	2.97	1.81	.81	1-7/16	1-3/8

Field attachable

247 'N' series

To determine the correct length of hose, subtract the cut-off factor for each end fitting from the overall length of assembly.

SAE 45° flare male rigid

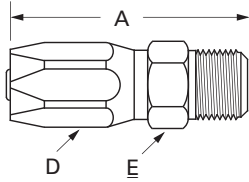

Hose I.D.	Tube size	Part number	Thread size	A	Hose cut-off factor	Hole dia.	Hex D	Hex E
3/16	1/4	24704N-304	7/16-20	1.84	1.13	.12	5/8	1/2
1/4	5/16	24705N-305	1/2-20	2.00	1.25	.18	11/16	9/16
5/16	3/8	24706N-306	5/8-18	2.18	1.28	.25	13/16	11/16
13/32	1/2	24708N-308	3/4-16	2.67	1.50	.36	15/16	13/16
1/2	5/8	24710N-310	7/8-14	3.00	1.72	.45	1-1/8	15/16
5/8	3/4	24712N-312	1-1/16-14	3.46	1.88	.55	1-1/4	1-1/8

Inverted male swivel straight

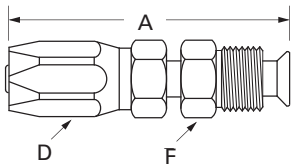

Hose I.D.	Pipe size	Part number	Thread size	A	Hose cut-off factor	Hole dia.	Hex D	Hex F
3/16	1/4	24704N-B04	7/16-24	2.54	1.81	.18	5/8	7/16
1/4	5/16	24705N-B05	1/2-20	2.75	2.00	.21	11/16	1/2
5/16	3/8	24706N-B06	5/8-18	2.91	2.00	.31	13/16	5/8
13/32	1/2	24708N-B08	3/4-18	3.63	2.50	.43	15/16	3/4

Inverted male swivel - extended

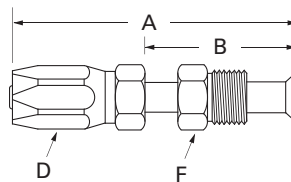

Hose I.D.	Tube size	Part number	Thread size	A	B	Hose cut-off factor	Hole dia.	Hex D	Hex F
5/16	1/4	24706N-B24	7/16-24	7.62	6.00	6.75	.15	13/16	7/16
5/16	5/16	24706N-B25	1/2-20	7.62	6.00	6.75	.21	16/16	1/2
5/16	3/8	24706N-B26	5/8-18	7.62	6.00	6.75	.24	13/16	5/8

To determine the correct length of hose, subtract the cut-off factor for each end fitting from the overall length of assembly.

Flareless tube rigid ermeto 7000 series

(With nut and sleeve)

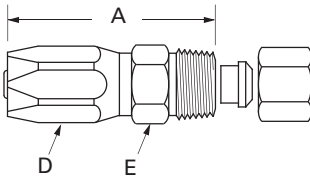

Hose I.D.	Tube size	Part number	Thread size	A	Hose cut-off factor	Hole dia.	Hex D	Hex E
5/16	1/4	24706N-754	7/16-20	2.02	1.13	.20	13/16	5/8
5/16	5/16	24706N-755	1/2-20	1.96	1.13	.23	13/16	5/8
5/16	3/8	24706N-756	9/16-18	1.98	1.13	.28	13/16	11/16
5/16	1/2	24706N-758	3/4-16	2.12	1.25	.28	13/16	13/16

JIC 37° female swivel

(Exceptions noted)

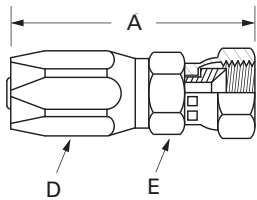

Hose I.D.	Tube size	Part number	Thread size	A	Hose cut-off factor	Hole dia.	Hex D	Hex E
3/16	1/4	24704N-604 ^a	7/16-20	2.01	1.31	.13	5/8	9/16
1/4	5/16	24705N-605 ^a	1/2-20	2.19	1.50	.18	11/16	5/8
5/16	1/4	24706N-604 ^a	7/16-20	2.19	1.31	.17	13/16	9/16
5/16	5/16	24706N-605 ^a	1/2-20	2.38	1.50	.25	13/16	5/8
5/16	3/8	24706N-606	9/16-18	2.35	1.50	.25	13/16	11/16
5/16	1/2	24706N-608 ^a	3/4-16	2.45	1.56	.39	13/16	7/8
13/32	1/2	24708N-608 ^a	3/4-16	2.82	1.75	.36	15/16	7/8
1/2	1/2	24710N-608 ^a	3/4-16	3.04	1.75	.39	1-1/8	7/8
1/2	5/8	24710N-610 ^a	7/8-14	3.04	1.75	.45	1-1/8	1
5/8	3/4	24712N-612	1-1/16-12	3.46	1.94	.55	1-1/4	1-1/4
7/8	1	24716N-616	1-5/16-12	3.21	2.00	.81	1-7/16	1-1/2

^a Swivel nuts are universal – both SAE 37° and 45° connections.

SAE 45° flare female swivel

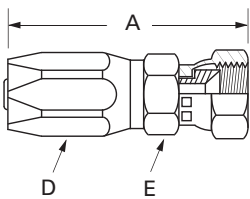

Hose I.D.	Tube size	Part number	Thread size	A	Hose cut-off factor	Hole dia.	Hex D	Hex E
5/16	3/8	24706N-406	5/8-18	2.36	1.46	.25	13/16	3/4
13/32	3/8	24708N-406	5/8-18	2.65	1.56	.28	15/16	3/4
5/8	3/4	24712N-412	1-1/16-14	3.49	1.92	.55	1-1/4	1-1/4

Straight tube – extended

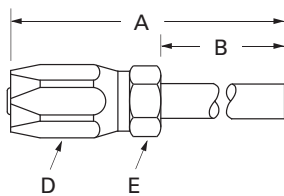

Hose I.D.	Tube size	Part number	Thread size	A	Hose cut-off factor	Hole dia.	Hex D	Hex E
3/16	1/4	24704N-T54	5.22	3.75	4.50	.12	5/8	1/2
1/4	5/16	24705N-T55	6.33	4.80	5.56	.18	11/16	1/2
5/16	3/8	24706N-T56	7.42	5.80	6.50	.25	13/16	1/2
13/32	1/2	24708N-T58	8.78	6.69	7.63	.36	15/16	3/4

Field attachable

247 'N' series

To determine the correct length of hose, subtract the cut-off factor for each end fitting from the overall length of assembly.

Inverted male swivel 45° tube elbow

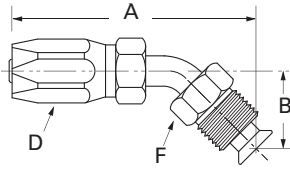

Hose I.D.	Pipe size	Part number	Thread size	A	B	Hose cut-off factor	Hole dia.	Hex D	Hex F
5/16	1/4	24705N-E45	1/2-20	3.42	1.14	2.63	.18	11/16	1/2

JIC 37° female swivel 45° tube elbow

(Exceptions noted for 45° flare – refer to footnotes)

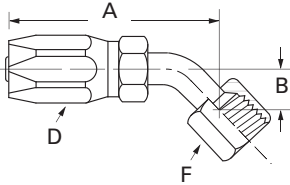

Hose I.D.	Tube size	Part number	Thread size	A	B	Hose cut-off factor	Hole dia.	Hex D	Hex F
3/16	1/4	24704N-684 ^a	7/16-20	1.85	.33	1.10	.12	5/8	9/16
1/4	5/16	24705N-685 ^a	1/2-20	2.07	.36	1.29	.18	11/16	5/8
5/16	3/8	24706N-686	9/16-18	2.29	.39	1.33	.25	13/16	11/16
13/32	1/2	24708N-688 ^a	3/4-16	2.99	.55	1.84	.33	15/16	7/8
1/2	5/8	24710N-690 ^a	7/8-14	3.24	.63	1.95	.45	1-1/8	1
5/8	3/4	24712N-692	1-1/16-12	3.778	.78	2.21	.55	1-1/4	1-1/4
7/8	1	24716N-696	1-5/16-12	4.21	1.07	2.85	.76	1-7/16	1-7/16

^a Swivel nuts are universal – both SAE 37° and 45° connections.

SAE 45° female swivel 45° tube elbow

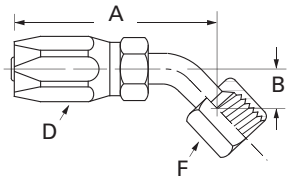

Hose I.D.	Tube size	Part number	Thread size	A	B	Hose cut-off factor	Hole dia.	Hex D	Hex F
5/16	1/4	24706N-484	7/16-20	2.61	.33	1.75	.25	13/16	5/8
5/16	3/8	24706N-486	5/8-18	2.23	.45	1.33	.25	13/16	3/4
5/8	3/4	24712N-492	1-1/16-14	3.78	.80	2.21	.55	1-1/4	1-1/4

Inverted male swivel 90° tube elbow

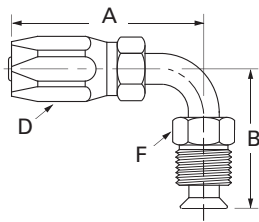

Hose I.D.	Pipe size	Part number	Thread size	A	B	Hose cut-off factor	Hole dia.	Hex D	Hex F
3/16	1/4	24704N-E04	7/16-24	2.36	1.69	1.62	.18	5/8	7/16
1/4	5/16	24705N-E05	1/2-20	2.53	1.69	1.75	.24	11/16	1/2
5/16	1/4	24706N-E04	7/16-24	2.41	1.36	1.50	.18	7/8	7/16
5/16	5/16	24706N-E05	1/2-20	2.63	1.69	1.73	.24	7/8	1/2
5/16	3/8	24706N-E06	5/8-18	2.63	1.73	1.73	.30	7/8	5/8

To determine the correct length of hose, subtract the cut-off factor for each end fitting from the overall length of assembly.

**JIC 37° female swivel
90° tube elbow**
(Exceptions noted)

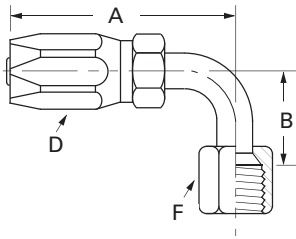

Hose I.D.	Tube size	Part number	Thread size	A	B	Hose cut-off factor	Hole dia.	Hex D	Hex F
3/16	1/4	24704N-664 ^a	7/16-20	1.74	.68	0.99	.12	5/8	9/16
1/4	5/16	24705N-665 ^a	1/2-20	1.96	.77	1.18	.18	11/16	5/8
5/16	3/8	24706N-666	9/16-18	2.13	.85	1.23	.25	13/16	11/16
13/32	1/2	24708N-668 ^a	3/4-16	2.76	1.09	1.61	.36	15/16	7/8
1/2	1/2	24710N-668 ^a	3/4-16	2.91	1.09	1.62	.45	15/16	7/8
1/2	5/8	24710N-670 ^a	7/8-14	2.94	1.23	1.65	.45	1-1/8	1
5/8	3/4	24712N-672	1-1/16-12	3.74	1.82	2.17	.55	1-1/4	1-1/4
7/8	1	24716N-676	1-5/16-12	3.55	2.39	2.28	.81	1-7/16	1-1/2

^a Swivel nuts are universal – both SAE 37° and 45° connections.

**SAE 45° female swivel
90° tube elbow**

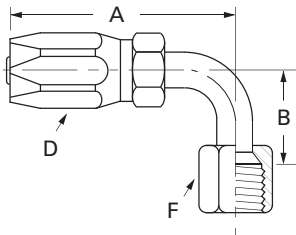

Hose I.D.	Tube size	Part number	Thread size	A	B	Hose cut-off factor	Hole dia.	Hex D	Hex F
5/16	3/8	24706N-466	5/8-18	2.13	.85	1.23	.25	13/16	3/4
5/8	3/4	24712N-472	1-1/16-14	3.74	1.82	2.17	.55	1-1/4	1-1/4

**JIC 37° female swivel
long drop 90° tube elbow**
(Exceptions noted)

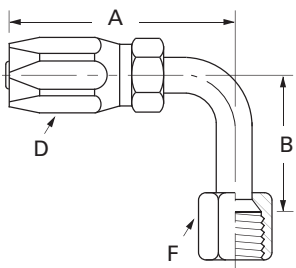

Hose I.D.	Tube size	Part number	Thread size	A	B	Hose cut-off factor	Hole dia.	Hex D	Hex F
3/16	1/4	24704N-644 ^a	7/16-20	1.74	1.80	0.99	.15	5/8	9/16
1/4	5/16	24705N-645 ^a	1/2-20	1.96	1.77	1.18	.21	11/16	5/8
5/16	3/8	24706N-646	9/16-18	2.13	2.18	1.23	.24	13/16	11/16
13/32	1/2	24708N-648 ^a	3/4-16	2.88	2.43	1.73	.33	15/16	7/8
1/2	5/8	24710N-650 ^a	7/8-14	3.19	2.57	1.90	.46	1-1/8	1
5/8	3/4	24712N-652	1-1/16-12	3.74	3.73	2.17	.58	1-1/4	1-1/4
7/8	1	24716N-656	1-5/16-12	3.55	4.58	2.28	.76	1-7/16	1-1/2

^a Swivel nuts are universal – both SAE 37° and 45° connections.

**SAE 45° female swivel
long drop 90° tube elbow**

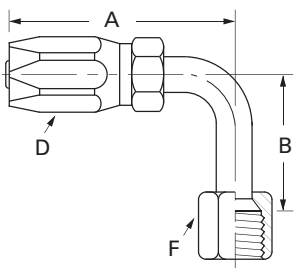

Hose I.D.	Tube size	Part number	Thread size	A	B	Hose cut-off factor	Hole dia.	Hex D	Hex F
5/16	1/4	24706N-444	7/16-20	2.54	1.80	1.63	.15	13/16	5/8
5/16	3/8	24706N-446	5/8-18	2.13	2.18	1.23	.24	13/16	3/4
5/8	3/4	24712N-452	1-1/16-14	3.74	3.73	2.17	.58	1-1/4	1-1/4

Field attachable

FC800 Evercool

Female ORS swivel

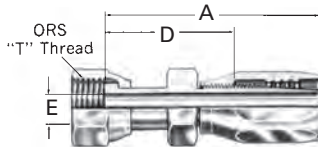

Hose size	Tube size	Part number	Thread size	A		Hose cut-off factor		Hole dia.		Hex	O-Ring ref
				mm	in.	mm	in.	mm	in.		
12	12	EJ5305-1212S	1-3/16-12	93,0	3.66	54,4	2.14	11,9	.47	1-1/4	FF91026-12
16	16	EJ5305-1616S	1-7/16-12	85,9	3.38	56,4	2.22	17,5	.69	1-5/8	FF91026-16
20	20	EJ5305-2020S	1-11/16-12	92,3	3.63	58,8	2.31	24,2	.95	1-7/8	FF91026-20
24	24	EJ5305-2424S	2-12	96,2	3.79	61,2	2.41	29,5	1.16	2-1/4	FF91026-24

Female ORS swivel 45° tube elbow

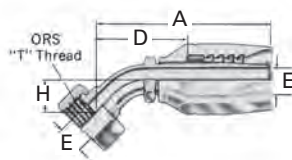

Hose size	Tube size	Part number	Thread size	A		Hose cut-off factor		Drop dim.		Hole dia.		Hex	O-Ring ref
				mm	in.	mm	in.	mm	in.	mm	in.		
12	12	EJ5361-1212S	1-3/16x12	97,5	3.84	57,4	2.26	21,0	.83	11,9	.47	1-3/8	FF91026-12
16	16	EJ5361-1616S	1-7/16x12	91,9	3.62	59,6	2.35	24,0	.94	17,5	.69	1-5/8	FF91026-16
20	20	EJ5361-2020S	1-11/16x12	103,6	4.08	69,1	2.72	25,0	.98	24,2	.95	1-7/8	FF91026-20
24	24	EJ5361-2424S	2x12	109,8	4.32	72,6	2.86	27,0	1.06	29,5	1.16	2-1/4	FF91026-24

Female ORS swivel 90° tube elbow

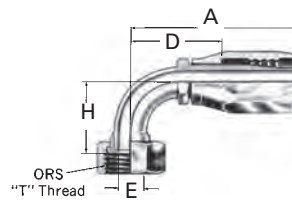

Hose size	Tube size	Part number	Thread size	A		Hose cut-off factor		Drop dim.		Hole dia.		Hex	O-Ring ref
				mm	in.	mm	in.	mm	in.	mm	in.		
12	12	EJ5362-1212S	1-3/16x12	95,0	3.74	55,1	2.17	48,3	1.90	11,9	.47	1-3/8	FF91026-12
16	16	EJ5362-1616S	1-7/16x12	90,2	3.55	57,9	2.28	56,4	2.22	17,5	.69	1-5/8	FF91026-16
20	20	EJ5362-2020S	1-11/16x12	102,1	4.02	67,3	2.65	63,5	2.50	24,2	.95	1-7/8	FF91026-20
24	24	EJ5362-2424S	2x12	112,3	4.42	75,4	2.97	68,6	2.70	29,5	1.16	2-1/4	FF91026-24

Female SAE 37° JIC swivel

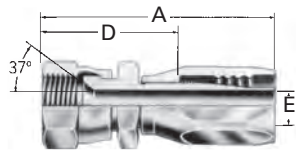

Hose size	Tube size	Part number	Thread size	A		Hose cut-off factor		Hole dia.		Hex	O-Ring ref
				mm	in.	mm	in.	mm	in.		
12	12	EJ5306-1212S	1-1/16-12	76,9	3.03	38,3	1.51	11,9	.47	1-1/4	FF91026-12
16	16	EJ5306-1616S	1-5/16-12	70,6	1.78	41,1	1.62	17,5	.69	1-1/2	FF91026-16
20	20	EJ5306-2020S	1-5/8-12	80,1	3.15	46,6	3.15	24,2	.95	2	FF91026-20
24	24	EJ5306-2424S	1-7/8-12	84,5	3.33	49,5	1.95	29,5	1.16	2-1/4	FF91026-24

Female SAE 37° JIC swivel
45° tube elbow

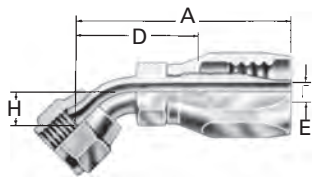

Hose size	Tube size	Part number	Thread size	A		Hose cut-off factor		Drop dim.		Hole dia.		Hex	O-Ring ref
				mm	in.	mm	in.	mm	in.	mm	in.		
12	12	EJ5359-1212S	1-1/16-12	96,1	3.78	56,2	2.21	19,7	.78	11,9	.47	1-1/4	FF91026-12
16	16	EJ5359-1616S	1-5/16-12	95,2	3.75	63,0	2.48	27,1	1.07	17,5	.69	1-1/2	FF91026-16
20	20	EJ5359-2020S	1-5/8-12	106,9	4.21	72,4	2.85	31,0	1.22	24,2	.95	2	FF91026-20

Female JIC/SAE 37° swivel
90° tube elbow

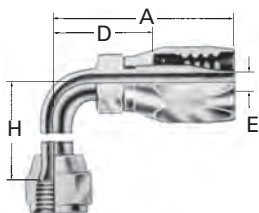

Hose size	Tube size	Part number	Thread size	A		Hose cut-off factor		Drop dim.		Hole dia.		Hex	O-Ring ref
				mm	in.	mm	in.	mm	in.	mm	in.		
12	12	EJ5360-1212S	1-1/16-12	95,0	3.74	55,1	2.17	46,3	1.82	11,9	.47	1-1/4	FF91026-12
16	16	EJ5360-1616S	1-5/16-12	90,3	3.56	58,2	2.29	60,7	2.39	17,5	.69	1-1/2	FF91026-16
20	20	EJ5360-2020S	1-5/8-12	102,1	4.02	67,3	2.65	69,8	2.75	24,2	.95	2	FF91026-20

Field attachable

FC800 Evercool

The following BOCK Fittings are MTO.
The Nipple and the Socket must be ordered separately.
Please contact Eaton Customer Service to determine leadtime.

BOCK, straight

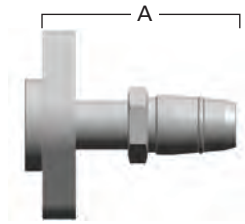

Hose size	Tube size	Part # for hose nipple	Thread size	A		Hose cut-off factor		Hole dia.		Nipple hex (metric)	Part# socket	Socket hex (metric)
				mm	in.	mm	in.	mm	in.			
16	16	GA25126-16	-	96,0	3.78	66,5	2.62	17,5	.69	24	G1212-16K	36
20	20	GA25126-20	-	101,5	4.00	68,0	2.68	24,2	.95	36	G1212-20K	46
24	24	GA25126-24	-	96,0	3.78	53,4	2.10	29,5	1.16	46	G1212-24K	50

BOCK, 45° tube elbow

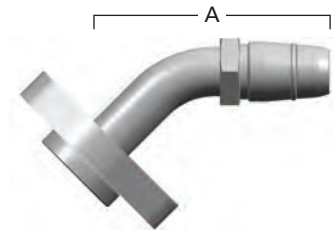

Hose size	Tube size	Part # for hose nipple	Thread size	A		Hose cut-off factor		Drop dim.		Hole dia.		Nipple Hex (metric)	Part # socket	Socket hex (metric)
				mm	in.	mm	in.	mm	in.	mm	in.			
16	16	GA25127-16	-	114,1	4.49	84,6	3.33	46,1	1.81	17,5	.69	24	G1212-16K	36
20	20	GA25127-20	-	122,6	4.83	89,1	3.51	46,1	1.81	24,2	.95	36	G1212-20K	46
24	24	GA24127-24	-	134,7	5.30	99,7	3.93	38,0	1.50	29,5	1.16	46	G1212-24K	50

BOCK, 90° tube elbow

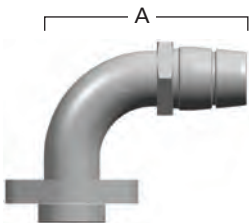

Hose size	Tube size	Part # for hose nipple	Thread size	A		Hose cut-off factor		Drop dim.		Hole dia.		Nipple hex (metric)	part # socket	Socket hex (metric)
				mm	in.	mm	in.	mm	in.					
16	16	GA25128-16	-	81,5	3.21	52,0	2.05	55,4	2.18	17,5	.69	24	G1212-16K	36
24	24	GA25128-24	-	109,5	4.31	74,5	2.93	90,5	3.56	29,5	1.16	46	G1212-24K	50

End connections & O-Rings

Refrigerant compatibility chart of refrigerant hoses

Refrigerant	Hose style GH001	FC800	FC802
R-1234YF	Y	Y	Y
R134A	Y	Y	Y
R407C	Y	Y	Y
R410A	Y	Y	Y
R404A	Y	*	Y

Y = Compatible N = Non-compatible

* Contact product support for application review

Lubricant compatibility chart

Lubricant	Hose style GH001	FC800	FC802
Mineral Oil	Y	*	Y
PAG	Y	Y	Y
Ester Oil	Y	Y	Y
Alkylbenzene	*	*	Y

Y = Compatible N = Non-compatible

* Contact product support for application review

Tubing identification

Size	Tubing style	Wall thickness
-6	SAE J526	0.035
-0608	SAE J526	0.035
-8	SAE J526	0.035
-0810	SAE J526	0.035
-10	SAE J525	0.049
-1012	SAE J525	0.049
-12	SAE J525	0.049
-16	SAE J525	0.0625

O-Rings for bump tube O-Ring seal and O-Ring pilot fittings

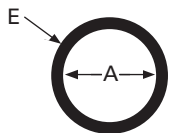

22546

Material: Chloroprene (Neoprene)
Durometer: 70
Temperature range: -65°F to +300°F
Color: Black

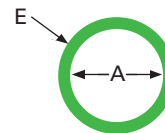

FF90178

Material: HNBR
Durometer: 70
Temperature range: -25°F to +300°F
Color: Green

O-Ring part number	O-Ring pilot dash size	A	E
22546-11	-06	.301	.07
22546-13	-08	.426	.07
22546-15	-10	.551	.07
22546-17	-12	.676	.07

O-Ring part number	O-Ring pilot dash size	A	E
FF90178-11	-06	.301	.0625
FF90178-13	-08	.426	.0625
FF90178-15	-10	.551	.0625
FF90178-17	-12	.676	.0625

E-Z Clip system

End connections & O-Rings

How to identify O-Ring pilot thread sizes

This connection is common to air conditioning systems, both in vehicle and commercial applications. Both the male and female halves of the connections have a pilot, either long or short. The seal

takes place by compressing an O-Ring adjacent to the bead of the tube. The threads hold the connection together mechanically.

Label Set: FF90646

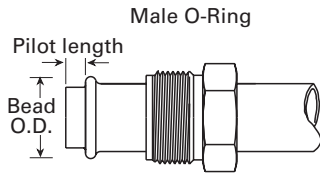

Inch size	Dash size	Male thread O.D. (inch)			Female thread I.D. (inch)		
		Nominal thread	Fraction	Decimal	Nominal thread	Fraction	Decimal
3/8	06	5/8 - 18	5/8	.62	5/8 - 18	9/16	.57
1/2	08	3/4 - 18	3/4	.75	3/4 - 16	11/16	.69
5/8	10	7/8 - 18	7/8	.87	7/8 - 14	13/16	.81
3/4	12	1-1/16 - 16	1-1/16	1.06	11/16 - 14	1	.99

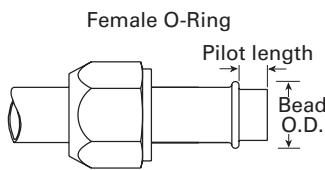

Inch size	Nominal tube size	Long pilot		Short pilot	
		Bead O.D. (inch)	Pilot length	Bead O.D. (inch)	Pilot length
3/8	06	.52	.28	.52	.19
1/2	08	.64	.39	.64	.19
5/8	10	.77	.39	.77	.19
3/4	12	.91	.39	.91	.19

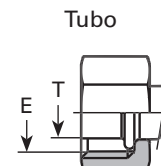
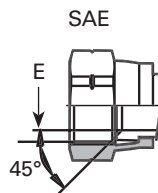
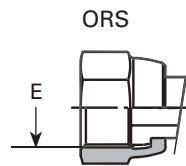
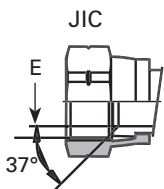

Size	JIC thread	ORS thread	ØE	SAE thread	ØE	Tubo thread	ØE	ØT
-4	7/16-20	9/16-18	12,9	7/16-20	—	—	—	—
-6	9/16-18	11/16-16	15,9	5/8-18	14,5	5/8-18	14,5	8,4
-8	3/4-18	13/16-16	19,1	3/4-16	17,5	3/4-16	17,5	11,6
-10	7/8-14	1-14	23,6	7/8-14	20,5	7/8-14	20,5	14,4
-12	1-1/16-12	1-3/16-12	28,1	1-1/16-14	25,2	1-1/16-14	25,2	17,5
-16	1-5/16-12	1-7/16-12	34,5	—	—	—	—	—
-20	—	1-11/16-12	40,7	—	—	—	—	—
-24	—	—	—	—	—	—	—	—

Fittings

FJ5984

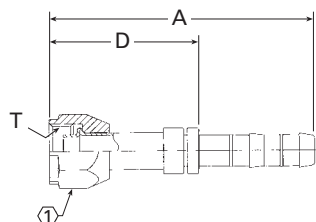

Straight – female O-Ring (short pilot)

Part number	Th'd "T"	Hose size	A Ref	D Ref	F Ref	H Ref	① Ref
FJ5984-0606S	5/8-18	6	3.14	1.62	—	—	0.75
FJ5984-0608S	5/8-18	8	3.16	1.62	—	—	0.75
FJ5984-0808S	3/4-16	8	3.56	2.02	—	—	0.88
FJ5984-0810S	3/4-16	10	3.57	2.02	—	—	0.88
FJ5984-1008S	7/8-14	8	3.62	2.08	—	—	0.88
FJ5984-1010S	7/8-14	10	3.63	2.08	—	—	1.06
FJ5984-1012S	7/8-14	12	3.66	2.08	—	—	1.06
FJ5984-1210S	1-1/16-14	10	4.25	2.62	—	—	1.25
FJ5984-1212S	1-1/16-14	12	4.25	2.67	—	—	1.25
FJ5984-1016S	7/8-14	16	3.76	2.08	—	—	1.06
FJ5984-1216S	1-1/16-14	16	4.35	2.67	—	—	1.25

FJ3632/EJ3111

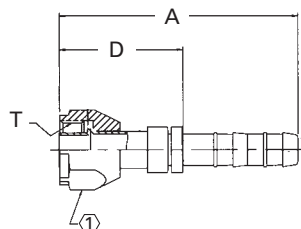

Straight – Female O-Ring, (long pilot)

Part number	Th'd "T"	Hose size	A Ref	D Ref	F Ref	H Ref	① Ref
FJ3632-0806S	3/4-16	6	2.91	1.36	—	—	0.88
FJ3632-0606S	5/8-18	6	3.04	1.51	—	—	0.75
FJ3632-0808S	3/4-16	8	3.20	1.66	—	—	0.88
FJ3632-1010S	7/8-14	10	3.63	2.08	—	—	1.06
FJ3632-1012S	7/8-14	12	3.66	2.08	—	—	1.06
FJ3632-1212S	1-1/8-14	12	4.25	2.67	—	—	1.25
EJ3111-1216S	1-1/16-14	16	4.35	2.67	—	—	1.25
EJ3111-1016S*	7/8-14	16	3.76	2.08	—	—	1.06

* MTO (made to order)

FJ3408

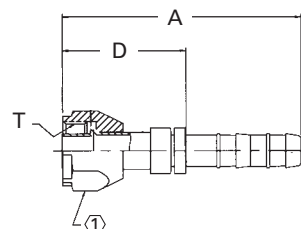

Straight – female O-Ring, metric thread (long pilot)

Part number	Th'd "T"	Hose size	A Ref	D Ref	F Ref	H Ref	① Ref
FJ3408-0808S	M20 x 1.5	8	3.20	1.66	—	—	0.94
FJ3408-0810S	M20 x 1.5	10	3.21	1.66	—	—	0.94
FJ3408-1212S	M27 x 2	12	4.25	2.67	—	—	1.25

FJ3055

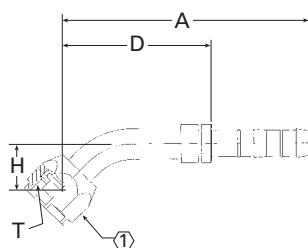

45° Elbow – female O-Ring (short pilot)

Part number	Th'd "T"	Hose size	A Ref	D Ref	F Ref	H Ref	① Ref
FJ3055-01-0606S	5/8-18	6	3.60	2.08	—	0.67	0.75
FJ3055-02-0608S	5/8-18	8	3.62	2.08	—	0.67	0.75
FJ3055-03-0808S	3/4-16	8	3.94	2.40	—	0.73	0.88
FJ3055-04-0810S	3/4-16	10	3.95	2.40	—	0.73	0.88
FJ3055-05-1010S	7/8-14	10	4.37	2.81	—	1.19	1.06
FJ3055-06-1012S	7/8-14	12	4.46	2.88	—	1.25	1.06
FJ3055-07-1212S	1-1/16-14	12	5.33	3.75	—	1.47	1.25
FJ3055-09-1216S	1-1/16-14	16	5.43	3.15	—	1.47	1.25
FJ3055-08-1016S	7/8-14	16	4.56	2.66	—	1.25	1.06

E-Z Clip system

Fittings

FJ5985

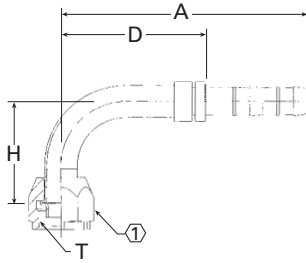

90° Elbow – female O-Ring (short pilot)

Part number	Th'd "T"	Hose size	A Ref	D Ref	F Ref	H Ref	① Ref
FJ5985-0606S	5/8-18	6	3.32	1.79	—	1.38	0.75
FJ5985-0608S	5/8-18	8	3.33	1.79	—	1.38	0.75
FJ5985-0806S	3/4-16	6	3.86	2.33	—	1.62	0.88
FJ5985-0808S	3/4-16	8	3.77	2.23	—	1.62	0.88
FJ5985-0810S	3/4-16	10	3.78	2.23	—	1.62	0.88
FJ5985-1010S	7/8-14	10	4.22	2.67	—	1.89	1.06
FJ5985-1012S	7/8-14	12	4.24	2.67	—	1.89	1.06
FJ5985-1210S	1-1/16-14	10	4.76	3.31	—	2.56	1.25
FJ5985-1212S	1-1/16-14	12	4.74	3.16	—	2.56	1.25
FJ5985-1216S	1-1/16-14	16	4.84	3.16	—	2.56	1.25

FJ3288

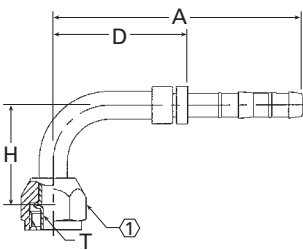

90° Female O-Ring (long pilot)

Part number	Th'd "T"	Hose size	A Ref	D Ref	F Ref	H Ref	① Ref
FJ3288-01-0606S	5/8-18	6	3.32	1.79	—	1.38	0.75
FJ3288-02-0808S	3/4-16	8	3.77	2.23	—	1.62	0.88
FJ3288-03-0806S	3/4-16	6	3.75	2.33	—	1.62	0.88
FJ3288-04-0810S	3/4-16	10	3.78	2.23	—	1.62	0.88
FJ3288-06-1216S	1-1/16-14	16	4.84	3.16	—	2.56	1.25
FJ3288-05-1016S	7/8-14	16	4.40	2.72	—	1.89	1.06
FJ3288-07-1012S	7/8-14	12	4.24	2.67	—	1.89	1.06
FJ3288-08-1212S	1-1/16-14	12	4.74	3.16	—	2.56	1.25
FJ3288-11-1010S	7/8-14	16	4.22	2.67	—	1.89	1.06
FJ3288-13-1216S	1-1/16-14	16	4.84	3.16	—	4.33	1.25

FJ3054

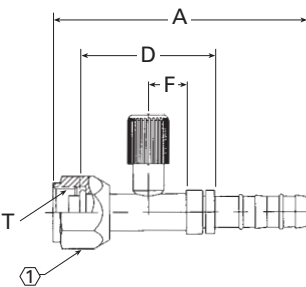

Straight – female O-Ring (short pilot) with R134a low side port

Part number	Th'd "T"	Hose size	A Ref	D Ref	F Ref	H Ref	① Ref
FJ3054-1010S	7/8-14	10	4.24	2.25	0.63	—	1.06
FJ3054-1012S	7/8-14	12	4.27	2.25	0.63	—	1.06
FJ3054-1016	7/8-14	16	4.42	2.30	0.63	—	1.06
FJ3054-1212S	1-1/16-14	12	4.58	2.43	0.54	—	1.25
FJ3054-1216S	1-1/16-14	16	4.68	2.43	0.54	—	1.25

FJ3053

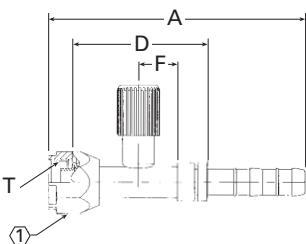

Straight – female O-Ring (short pilot) with R134a high side port

Part number	Th'd "T"	Hose size	A Ref	D Ref	F Ref	H Ref	① Ref
FJ3053-0606S	5/8-18	6	3.91	2.10	0.63	—	0.75
FJ3053-0806S	3/4-16	6	4.06	2.26	0.63	—	0.88
FJ3053-0808S	3/4-16	8	4.09	2.16	0.63	—	0.88
FJ3053-0810S	3/4-16	10	4.09	2.16	0.63	—	0.88

FJ3162

Straight – female O-Ring (long pilot) with switch port (7/16-20 thd)

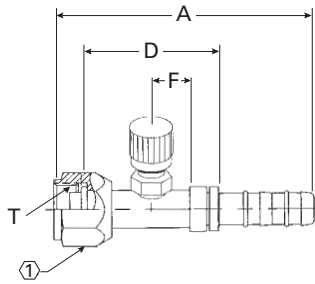

Part number	Th'd "T"	Hose size	A Ref	D Ref	F Ref	H Ref	① Ref
FJ3162-0808S	3/4-16	8	4.09	2.16	0.79	—	0.88
FJ3162-0810S*	3/4-16	10	4.48	2.53	0.63	—	0.88
FJ3162-1010S	7/8-14	10	4.25	2.25	0.79	—	1.06
FJ3162-1012S	7/8-14	12	4.27	2.25	0.79	—	1.06
FJ3162-1212S	1-1/16-14	12	4.86	2.71	0.79	—	1.25
FJ3162-1016S	7/8-14	16	4.42	2.30	0.79	—	1.06

* MTO (made to order)

FJ3416

Straight – female O-Ring (long pilot) with switch port (M10 X 1.25)

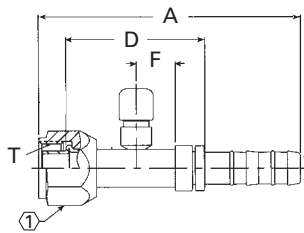

Part number	Th'd "T"	Hose size	A Ref	D Ref	F Ref	H Ref	① Ref
FJ3416-01-1010S	7/8-14	10	4.25	2.25	0.63	—	1.06
FJ3416-02-0808S*	7/8-16	8	4.46	2.53	0.63	—	0.88

* MTO (made to order)

FJ3461

Straight – female O-Ring (long pilot) with switch port (M12 X 1.25)

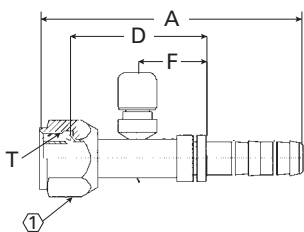

Part number	Th'd "T"	Hose size	A Ref	D Ref	F Ref	H Ref	① Ref
FJ3461-01-1010S	7/8-14	10	4.25	2.25	.63	—	1.06
FJ3461-02-1012S	7/8-14	12	4.27	2.25	.63	—	1.06
FJ3461-03-1212S	1-1/16-14	12	4.86	2.71	.54	—	1.25

EJ3299

Straight - female O-Ring (short pilot) with switch port (M12 X 1.25)

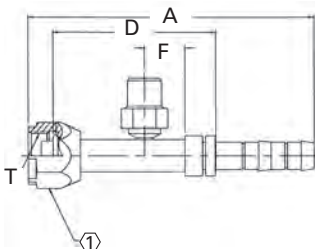

Part number	Th'd "T"	Hose size	A Ref	D Ref	F Ref	H Ref	① Ref
EJ3299-01-0808S	3/4-16	8	4.46	2.53	.63	—	.88

* MTO (made to order)

E-Z Clip system

Fittings

FJ3363

Straight – female O-Ring (short pilot) with R134a high side port and female switch connection, (1/8-27 thd)

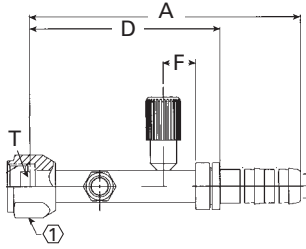

Part number	Th'd "T"	Hose size	A Ref	D Ref	F Ref	H Ref	Ⓛ Ref
FJ3363-03-0808S*	3/4-16	8	5.16	3.62	.63	—	.88
FJ3363-02-0810S*	3/4-16	10	5.54	3.62	.63	—	.88

* MTO (made to order)

FJ3363

Straight – female O-Ring (short pilot) with R134a low side port and female switch connection, (1/8-27 thd)

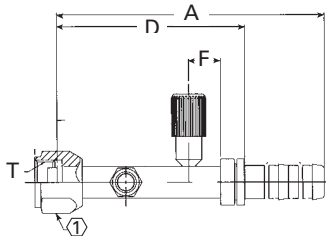

Part number	Th'd "T"	Hose size	A Ref	D Ref	F Ref	H Ref	Ⓛ Ref
FJ3363-01-1012S*	7/8-14	12	5.30	3.72	0.63	—	1.06

* MTO (made to order)

FJ3365

45° Female O-Ring (short pilot) with R134a low side port and switch port (1/8-27 thd)

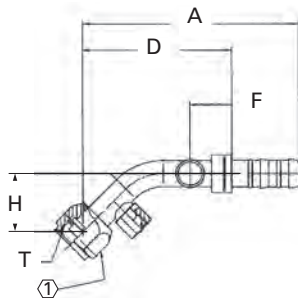

Part number	Th'd "T"	Hose size	A Ref	D Ref	F Ref	H Ref	Ⓛ Ref
FJ3365-01-1012S*	7/8-14	12	5.09	3.51	0.50	1.43	1.13

* MTO (made to order)

FJ3230

45° Female O-Ring (long pilot) with switch port (7/16-20 thd)

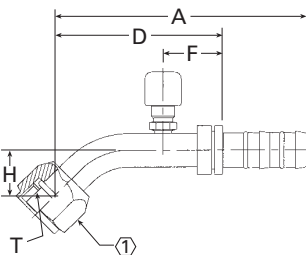

Part number	Th'd "T"	Hose size	A Ref	D Ref	F Ref	H Ref	Ⓛ Ref
FJ3230-01-0810S	3/4-16	10	4.61	3.06	0.63	0.80	0.88
FJ3230-02-1012S	7/8-14	12	4.73	3.15	0.63	0.89	1.06
FJ3230-03-0808S	3/4-16	8	4.43	4.93	0.63	0.73	0.88
FJ3230-04-1010S	7/8-14	10	5.00	3.45	0.63	1.19	1.06
FJ3230-05-1016S	7/8-14	16	4.88	3.15	0.63	0.89	1.06
FJ3230-06-1216S*	1-1/16-14	16	5.65	3.45	1.04	1.36	1.25

* MTO (made to order)

EJ3410

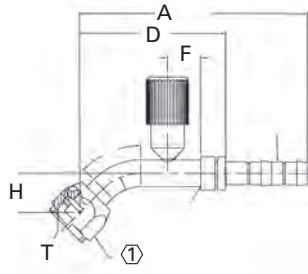

45° Female O-Ring (short pilot) with R134a high side port

Part number	Th'd "T"	Hose size	A Ref	D Ref	F Ref	H Ref	① Ref
EJ3410-0808S	3/4-16	8	4.3	2.76	0.62	0.73	0.88

EJ3543

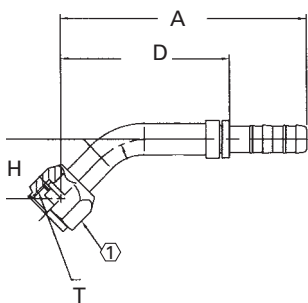

45° Female O-Ring (short pilot) with R134a low side port (rotated 270°)

Part number	Th'd "T"	Hose size	A Ref	D Ref	F Ref	H Ref	① Ref
EJ3543-1010S	7/8-14	10	4.99	3.44	0.52	1.19	1.06

FJ3012

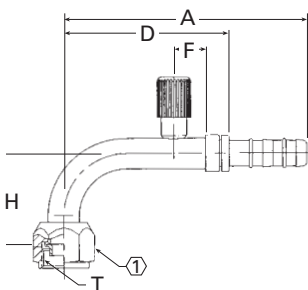

90° Female O-Ring (short pilot) with R134a low side port

Part number	Th'd "T"	Hose size	A Ref	D Ref	F Ref	H Ref	① Ref
FJ3012-02-1010S	7/8-14	10	4.88	3.33	0.63	1.89	1.06
FJ3012-01-1012S	7/8-14	12	4.83	3.25	0.63	1.89	1.06
FJ3012-03-1212S	1-1/16-14	12	5.1	3.52	0.63	2.56	1.25
FJ3012-04-1216S	1-1/16-14	16	5.2	3.52	0.63	2.56	1.25
FJ3012-05-1016S	7/8-14	16	5.2	3.52	0.63	1.89	1.06

FJ3013/EJ3302

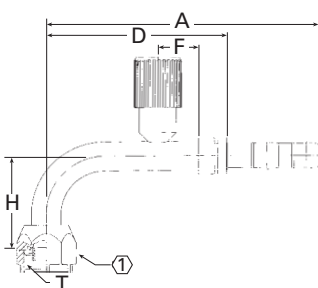

90° Female O-Ring (short pilot) with R134a high side port

Part number	Th'd "T"	Hose size	A Ref	D Ref	F Ref	H Ref	① Ref
FJ3013-02-0606S	5/8-18	6	4.35	2.82	0.63	1.38	0.75
FJ3013-03-0808S	3/4-16	8	4.61	3.07	0.69	1.62	0.88
FJ3013-01-0810S	3/4-16	10	4.53	2.98	0.69	1.62	0.88
FJ3013-06-1010S	7/8-14	10	4.29	3.24	0.94	2.37	1.06
EJ3302-01-0608S	M18 x 1.5	8	4.36	2.82	0.94	1.38	0.88
EJ3302-02-0808S	M20 x 1.5	8	4.52	2.98	0.69	1.62	0.94

E-Z Clip system

Fittings

FJ3289

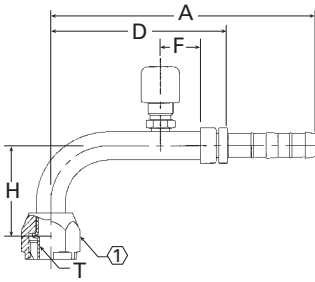

90° Female O-Ring (long pilot) with charge port (7/16-20 thd)

Part number	Th'd "T"	Hose size	A Ref	D Ref	F Ref	H Ref	① Ref
FJ3289-03-0606S	5/8-18	6	4.35	2.82	0.69	1.35	0.75
FJ3289-01-0808S	3/4-16	8	4.61	2.59	0.69	1.62	0.88
FJ3289-02-1010S	7/8-14	10	4.8	2.77	0.63	1.93	1.06
FJ3289-04-0810S	3/4-16	10	4.62	2.59	0.69	1.62	0.88
FJ3289-05-1012S	7/8-14	12	4.82	2.77	0.63	1.93	1.06
FJ3289-06-1216S	1-1/16-14	16	4.83	3.25	0.63	1.93	1.25

FJ3163

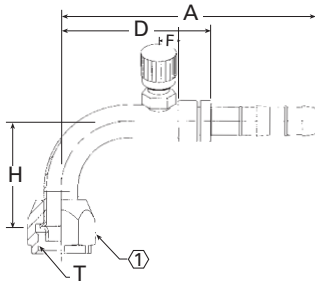

90° Elbow – female O-Ring (short pilot) with charge port (7/16-20 thd)

Part number	Th'd "T"	Hose size	A Ref	D Ref	F Ref	H Ref	① Ref
FJ3163-01-1010S	7/8-14	10	4.80	3.25	0.79	1.89	1.06
FJ3163-02-1212S	1-1/16-14	12	5.08	3.50	0.79	2.56	1.25

FJ3047

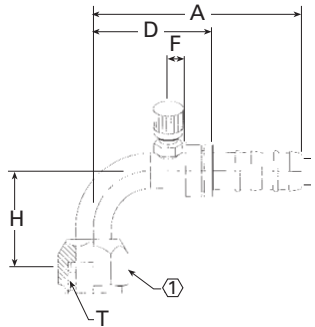

90° Female O-Ring (long pilot) with charge port (7/16-20 thd) – 45° port rotation

Part number	Th'd "T"	Hose size	A Ref	D Ref	F Ref	H Ref	① Ref
FJ3047-1012S	7/8-14	12	4.06	2.48	0.50	1.69	1.06
FJ3047-1016S	7/8-14	16	4.21	2.53	0.50	1.69	1.06

EJ3298

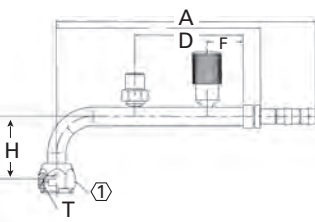

90° Female O-Ring (short pilot) with R134a high side port and a switch port (M10 x 1.25)

Part number	Th'd "T"	Hose size	A Ref	D Ref	F Ref	H Ref	① Ref
EJ3298-01-0808S	3/4-16	8	7.22	5.67	1	1.71	0.88

* MTO (made to order)

FJ3444

90° Female O-Ring (long pilot) with charge port (7/16-20 thd) – 90° port rotation

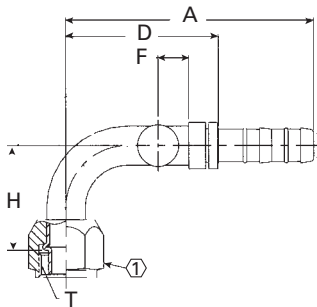

Part number	Th'd "T"	Hose size	A Ref	D Ref	F Ref	H Ref	① Ref
FJ3444-1010S	7/8-14	10	4.03	2.48	.50	1.69	1.06

FJ3460

90° Female O-Ring (long pilot) with switch port (M12 X 1.5)

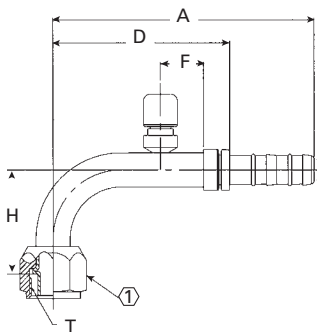

Part number	Th'd "T"	Hose size	A Ref	D Ref	F Ref	H Ref	① Ref
FJ3460-01-1010S	7/8-14	10	4.80	3.25	0.79	1.89	1.06
FJ3460-02-1012S	7/8-14	12	4.83	3.25	0.79	1.89	1.06
FJ3460-03-1212S	1-1/16-14	12	5.08	3.50	.54	2.56	1.25

EJ3297

90° Female O-Ring (short pilot) with switch port (M10 X 1.25)

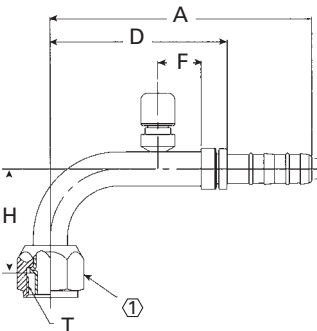

Part number	Th'd "T"	Hose size	A Ref	D Ref	F Ref	H Ref	① Ref
EJ3297-01-0808S*	3/4-16	8	4.16	2.62	0.87	1.68	0.88

* MTO (made to order)

FJ3052

Straight male O-Ring (short pilot)

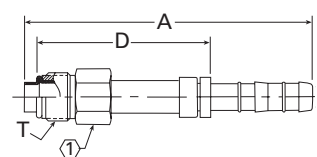

Part number	Th'd "T"	Hose size	A Ref	D Ref	F Ref	H Ref	① Ref
FJ3052-0606S	5/8-18	6	3.41	1.70	—	—	0.62
FJ3052-0608S	5/8-18	8	3.43	1.70	—	—	0.62
FJ3052-0808S	3/4-18	8	4.37	2.64	—	—	0.75
FJ3052-0810S	3/4-18	10	4.38	2.64	—	—	0.75
FJ3052-1010S	7/8-18	10	3.66	1.92	—	—	0.88
FJ3052-1012S	7/8-18	12	3.68	1.92	—	—	0.88
FJ3052-1212S	1-1/16-16	12	3.68	1.92	—	—	1.06
FJ3052-1016S	7/8-18	16	4.33	2.47	—	—	0.88
FJ3052-1216S	1-1/16-16	16	4.28	2.42	—	—	1.06

E-Z Clip system

Fittings

FJ3116

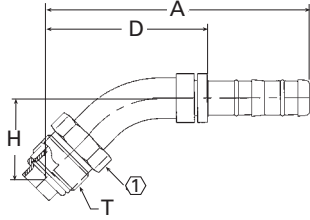

45° Male O-Ring (short pilot)

Part number	Th'd "T"	Hose size	A Ref	D Ref	F Ref	H Ref	① Ref
FJ3116-01-0606S	5/8-18	6	3.99	2.47	—	0.94	0.62
FJ3116-04-0608S	5/8-18	8	4.01	2.47	—	0.94	0.62
FJ3116-03-0808S	3/4-18	8	4.59	2.83	—	1.20	0.75
FJ3116-02-1010S	7/8-18	10	4.65	3.10	—	1.46	0.88
FJ3116-05-1012S	7/8-18	12	4.68	3.10	—	1.47	0.88
FJ3116-06-1212S	1 1/16-16	12	4.90	3.32	—	1.53	1.06
FJ3116-07-1216S	1-1/16-16	16	4.68	2.89	—	1.53	1.06
FJ3116-08-1016S	7/8-18	16	4.78	3.10	—	1.47	0.88

FJ3019

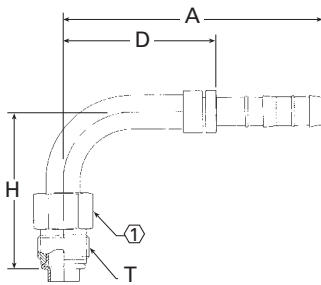

90° Male O-Ring (short pilot)

Part number	Th'd "T"	Hose size	A Ref	D Ref	F Ref	H Ref	① Ref
FJ3019-03-0606S	5/8-18	6	3.33	1.80	—	1.77	0.62
FJ3019-02-0608S	5/8-18	8	3.34	1.80	—	1.77	0.62
FJ3019-04-0808S	3/4-18	8	3.77	2.23	—	2.31	0.75
FJ3019-06-0810S	3/4-18	10	3.78	2.23	—	2.31	0.75
FJ3019-01-1012S	7/8-18	12	4.24	2.67	—	2.45	0.88
FJ3019-05-1212S	1-1/16-16	12	4.22	2.64	—	2.79	1.06
FJ3019-07-1010S	7/8-18	10	4.22	2.67	—	2.45	0.88
FJ3019-09-1216S	1-1/16-16	16	4.32	2.74	—	2.79	1.06
FJ3019-10-1016S	7/8-18	16	4.20	3.03	—	2.45	0.88

FJ3132

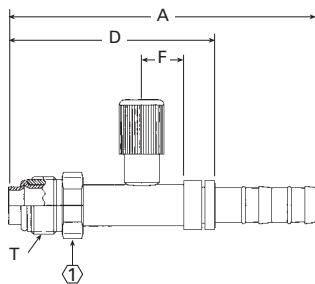

Straight male O-Ring (short pilot) with R134a low side port

Part number	Th'd "T"	Hose size	A Ref	D Ref	F Ref	H Ref	① Ref
FJ3132-01-1010S	7/8-18	10	4.43	2.70	0.63	—	0.88
FJ3132-02-1012S	7/8-18	12	4.46	2.70	0.63	—	0.88

FJ3131

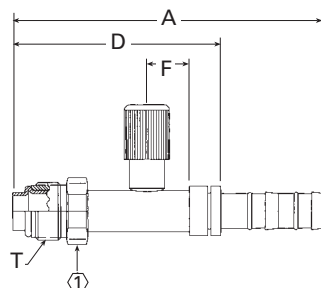

Straight male O-Ring (short pilot) with R134a high side port

Part number	Th'd "T"	Hose size	A Ref	D Ref	F Ref	H Ref	① Ref
FJ3131-01-0606S	5/8-18	6	4.18	2.47	0.63	—	0.62
FJ3131-02-0808S	3/4-18	8	4.58	2.85	0.63	—	0.75
FJ3131-03-1010S	7/8-18	10	4.34	2.61	0.63	—	0.88

FJ3134

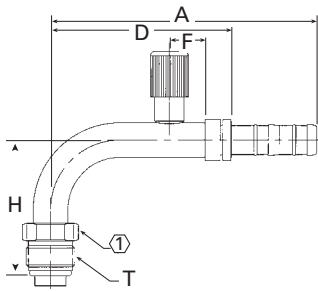

90° Elbow male O-Ring (short pilot) with R134a high side port

Part number	Th'd "T"	Hose size	A Ref	D Ref	F Ref	H Ref	① Ref
FJ3134-01-0606S	5/8-18	6	4.34	2.82	0.63	1.75	0.62
FJ3134-02-0808S	3/4-18	8	4.61	3.07	0.63	2.31	0.75
FJ3134-03-1010S	7/8-18	10	4.81	3.25	0.63	2.34	0.88

FJ3611

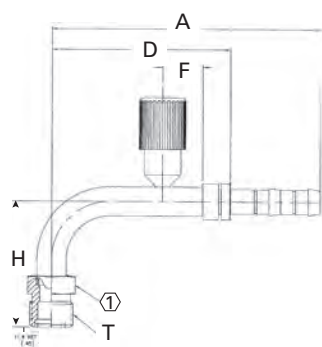

90° Elbow male MIO with R134a high side port

Part number	Th'd "T"	Hose size	A Ref	D Ref	F Ref	H Ref	① Ref
FJ3611-01-0808S	3/4-16	8	4.61	3.07	0.69	2.17	0.813

FJ3135

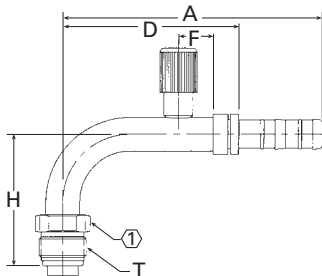

90° Elbow male O-Ring (short pilot) with R134a low side port

Part number	Th'd "T"	Hose size	A Ref	D Ref	F Ref	H Ref	① Ref
FJ3135-01-1010S	7/8-18	10	4.81	3.25	0.63	2.34	0.88
FJ3135-02-1012S	7/8-18	12	4.81	3.25	0.63	2.34	0.88

FJ3026

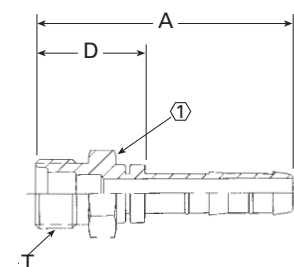

Male MIO (male insert O-Ring) straight

Part number	Th'd "T"	Hose size	A Ref	D Ref	F Ref	H Ref	① Ref
FJ3026-0606S	5/8-18	6	3.36	1.83	—	—	0.690
FJ3026-0808S	3/4-16	8	2.69	1.15	—	—	0.810
FJ3026-1010S	7/8-14	10	2.90	1.35	—	—	0.940
FJ3026-1012S	7/8-14	12	4.11	2.50	—	—	0.940
FJ3026-1212S	1-1/16-14	12	4.29	2.71	—	—	1.125

E-Z Clip system

Fittings

FJ3056

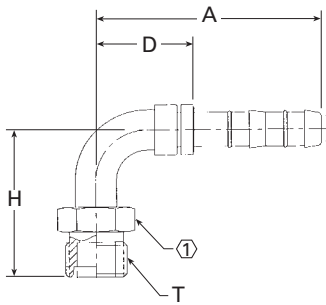

90° Male MIO – (male insert O-Ring)

Part number	Th'd "T"	Hose size	A Ref	D Ref	F Ref	H Ref	① Ref
FJ3056-01-0606S	5/8-18	6	2.50	0.98	—	1.44	0.69
FJ3056-02-0808S	3/4-16	8	2.74	1.20	—	1.82	0.81
FJ3056-03-1010S	7/8-14	10	3.09	1.54	—	2.13	0.94
FJ3056-04-0810S	3/4-16	10	2.75	1.20	—	1.82	0.81
FJ3056-05-0608S	5/8-18	8	2.52	0.98	—	1.44	0.69

FJ3057

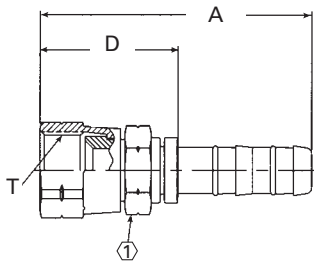

Female SAE 45° flares

Part number	Th'd "T"	Hose size	A Ref	D Ref	F Ref	H Ref	① Ref
FJ3057-01-0606S	5/8-18	6	2.88	1.35	—	—	0.56
FJ3057-08-0806S	3/4-16	6	2.94	1.42	—	—	0.69
FJ3057-02-0608S	5/8-18	8	3.14	1.62	—	—	0.75
FJ3057-03-0808S	3/4-16	8	2.96	1.42	—	—	0.69
FJ3057-04-0810S	3/4-16	10	3.56	2.02	—	—	0.88
FJ3057-05-1010S	7/8-14	10	3.63	2.08	—	—	1.00
FJ3057-06-1012S	7/8-14	12	3.66	2.08	—	—	1.00
FJ3057-07-1212S	1-1/16-14	12	3.20	1.62	—	—	1.25

FJ3731/FJ3508

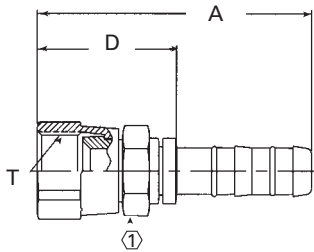

Straight – female 37° flares

Part number	Th'd "T"	Hose size	A Ref	D Ref	F Ref	H Ref	① Ref
FJ3731-0404S	7/16-20	4	2.75	2.08	—	—	0.56
FJ3731-0606S	9/16-18	6	3.66	2.13	—	—	0.68
FJ3731-0808S	3/4-16	8	4.35	2.81	—	—	0.88
FJ3731-1010S	7/8-14	10	4.21	2.66	—	—	1.00
FJ3731-1212S	1-1/16-12	12	4.62	3.04	—	—	1.25
FJ3731-1616S	1-5/16-12	16	5.99	4.31	—	—	1.50
FJ3508-0404C	7/16-20	4	1.87	1.20	—	—	0.56
FJ3508-0808C	3/4-16	8	2.96	1.42	—	—	0.88
FJ3058-1010C	7/8-14	10	3.15	1.59	—	—	1.00
FJ3058-1616C	1-15/16-12	16	3.50	1.82	—	—	1.50

Items ending in "C" are stainless

EJ3534

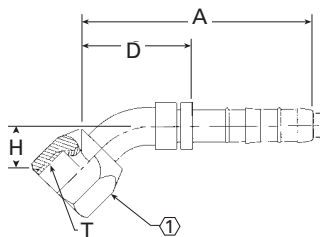

45° Female JIC 37° flare

Part number	Th'd "T"	Hose size	A Ref	D Ref	F Ref	H Ref	① Ref
EJ3534-02-0606S	9/16-18	6	3.31	1.79	—	0.74	1.00
EJ3534-03-0608S	9/16-18	8	3.76	3.32	—	1.10	0.68
EJ3534-04-0808S	3/4-16	8	4.04	2.49	—	1.10	0.88
EJ3534-05-1010S	7/8-14	10	4.21	2.66	—	1.27	1.25
EJ3534-06-1212S	1-1/16-12	12	4.30	2.73	—	1.33	1.50
EJ3534-07-1616S	1-5/16-12	16	5.46	3.79	—	1.92	1.50
EJ3534-01-0404S	7/16-20	4	2.37	1.70	—	0.63	0.56

FJ3059

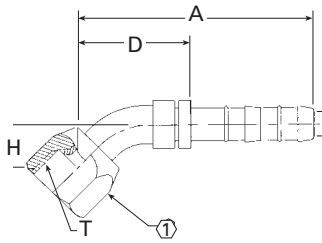

45° Female SAE 45° and universal flares

Part number	Th'd "T"	Hose size	A Ref	D Ref	F Ref	H Ref	① Ref
FJ3059-0404S*	7/16-20	4	1.57	0.91	—	0.33	0.56
FJ3059-01-0606S†	5/8-18	6	2.61	1.08	—	0.39	0.75
FJ3059-02-0608S†	5/8-18	8	2.62	1.08	—	0.39	0.75
FJ3059-03-0808S*	3/4-16	8	2.97	1.43	—	0.55	0.88
FJ3059-04-0810S*	3/4-16	10	2.98	1.43	—	0.55	0.88
FJ3059-05-1010S*	7/8-14	10	3.08	1.53	—	0.63	1.00
FJ3059-06-1012S*	7/8-14	12	3.11	1.53	—	0.63	1.00

† Double notch in nut for universal type identification

* Universal flare

FJ3133

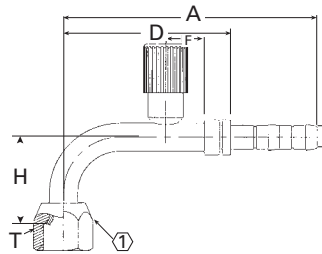

90° Female SAE 45° with high side charge port (R134a)

Part number	Th'd "T"	Hose size	A Ref	D Ref	F Ref	H Ref	① Ref
FJ3133-01-0606S	5/8-18	6	4.35	2.82	0.63	1.28	0.75
FJ3133-02-0808S	3/4-16	8	4.61	3.07	0.63	1.53	0.88
FJ3133-03-1010S	7/8-14	10	4.80	3.25	0.63	1.84	0.88

FJ3366

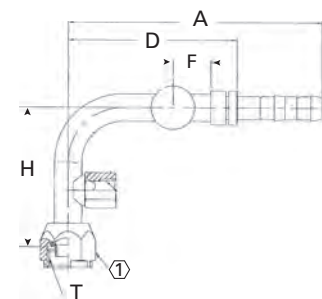

SAE 90° and with R134a C/port and switch port (1/8-27 thd)

Part number	Th'd "T"	Hose size	A Ref	D Ref	F Ref	H Ref	① Ref
FJ3366-01-0810S*	3/4-16	10	4.62	3.07	0.69	2.53	0.875
FJ3366-02-0808S*	3/4-16	8	4.61	3.07	0.69	2.53	0.875

* MTO (made to order)

FJ3149

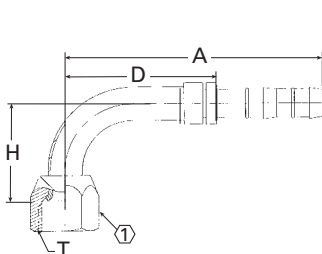

90° Female SAE 45° and universal flares

Part number	Th'd "T"	Hose size	A Ref	D Ref	F Ref	H Ref	① Ref
FJ3149-0404S*	7/16-20	4	1.47	0.80	—	0.68	0.56
FJ3149-01-0606S†	5/8-18	6	2.51	0.98	—	0.85	0.75
FJ3149-02-0608S†	5/8-18	8	2.52	0.98	—	0.85	0.75
FJ3149-03-0808S*	3/4-16	8	2.74	1.20	—	1.09	0.88
FJ3149-04-1010S*	7/8-14	10	3.09	1.54	—	1.19	1.00
FJ3149-05-1012S*	7/8-14	12	3.09	1.54	—	1.19	1.00
FJ3149-06-1212S†	1-1/16-14	12	3.68	2.11	—	1.80	1.25
FJ3149-07-0810S*	7/8-14	10	2.83	1.30	—	1.09	0.88

† Double notch in nut for universal type identification

* Universal flare

E-Z Clip system

Fittings

EJ3533

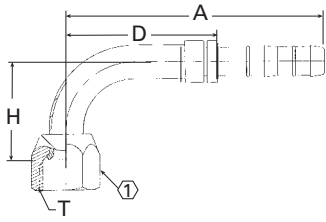

90° Female JIC 37° flare

Part number	Th'd "T"	Hose size	A Ref	D Ref	F Ref	H Ref	① Ref
EJ3533-02-0606S	9/16-18	6	3.27	1.74	—	1.69	0.69
EJ3533-03-0608S	9/16-18	8	3.28	1.74	—	1.69	0.69
EJ3533-04-0808S	3/4-16	8	3.14	1.60	—	1.77	0.88
EJ3533-05-1010S	7/8-14	10	3.78	2.23	—	2.59	1.00
EJ3533-06-1212S	1 1/16-12	12	4.11	2.53	—	3.02	1.25
EJ3533-07-1616S	1 5/16-12	16	5.16	3.48	—	3.86	1.50
EJ3533-01-0404S	7/16-20	4	2.09	1.42	—	1.21	0.56

GA23911

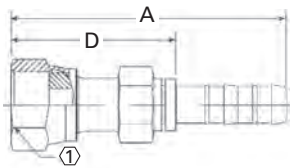

Straight - ORS female swivel metric hex nut

Part number	Th'd "T"	Hose size	A Ref	D Ref	F Ref	H Ref	① Ref
GA23911-4-4*	9/16-18	4	1.86	1.19	—	—	17mm
GA23911-6-6*	1-1/16-16	6	2.95	1.43	—	—	22mm
GA23911-8-8*	1-3/16-16	8	3.17	1.62	—	—	24mm
GA23911-10-12*	1-14	12	3.32	1.74	—	—	30mm
GA23911-10-10*	1-14	10	3.33	1.78	—	—	30mm
GA23911-12-12*	1-3/16-12	12	3.32	1.52	—	—	41mm
GA23911-16-16*	1-5/16-12	16	3.30	1.52	—	—	41mm

* GA Part numbers have a metric hex

FJ3161/GA23912

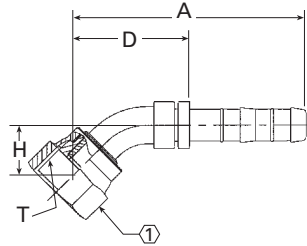

45° ORS female swivel

Part number	Th'd "T"	Hose size	A Ref	D Ref	F Ref	H Ref	① Ref
FJ3161-05-0404S	9/16-18	4	1.86	1.01	—	0.41	0.69
FJ3161-01-0606S	11/16-16	6	2.65	1.12	—	0.44	0.81
FJ3161-02-0808S	13/16-16	8	3.02	1.47	—	0.59	0.94
FJ3161-03-1010S	1-14	10	3.22	1.67	—	0.70	1.13
FJ3161-04-1008S	1-14	8	3.32	1.78	—	0.70	1.13
GA23912-10-8*	1-14	8	3.50	1.96	—	0.68	30mm
GA23912-12-12*	1-3/16-12	12	4.23	2.65	—	0.83	36mm
F3161-08-0810S	13/16-16	10	3.02	1.47	—	0.59	0.940
GA23912-10-10*	1-14	10	3.77	2.22	—	0.68	30mm
GA23912-8-8*	13/16-16	8	3.43	1.89	—	0.59	30mm

* GA Part numbers have a metric hex

FJ5994/GA23913

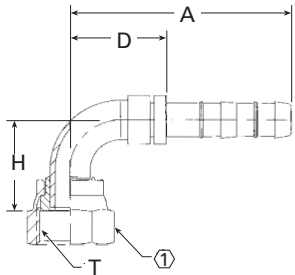

90° ORS female swivel

Part number	Th'd "T"	Hose size	A Ref	D Ref	F Ref	H Ref	① Ref
FJ5994-01-0606S	1-1/16-16	6	2.50	0.98	—	0.91	0.81
FJ5994-02-0808S	13/16-16	8	2.74	1.20	—	1.15	0.94
FJ5994-04-1010S	1-14	10	3.09	1.53	—	1.27	1.12
FJ5994-03-1212S	1-3/16-12	12	3.36	1.78	—	1.90	1.38
FJ5994-05-0406S	9/16-18	6	2.44	0.92	—	0.82	0.69
FJ5994-05-1012S	1-14	12	3.11	1.53	—	1.78	1.13
FJ5994-07-0806S	13/16-16	6	2.66	1.10	—	1.15	0.94
FJ5994-09-1016S	1-14	16	3.30	1.62	—	1.78	1.125
GA23913-4-4*	9/16-18	4	2.04	1.37	—	0.82	17mm
GA23913-10-12*	1-14	12	3.67	2.10	—	1.54	30mm

* GA Part numbers have a metric hex

FJ3319

90° ORS female swivel (long drop)

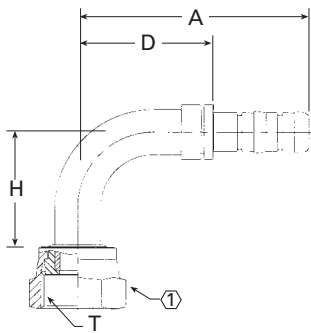

Part number	Th'd "T"	Hose size	A Ref	D Ref	F Ref	H Ref	① Ref
FJ3319-1212S	1-3/16-12	12	3.82	2.24	—	2.38	1.13

FJ3136

Straight male O-Ring (rigid) metric thread

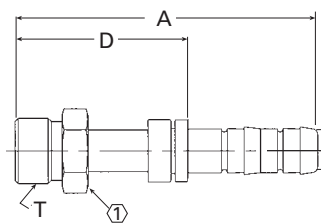

Part number	Th'd "T"	Hose size	A Ref	D Ref	F Ref	H Ref	① Ref
FJ3136-0810S	M20 x 1.5	10	3.62	2.07	0.69	—	0.88

FJ3192

45° Female O-Ring (long pilot) metric thread

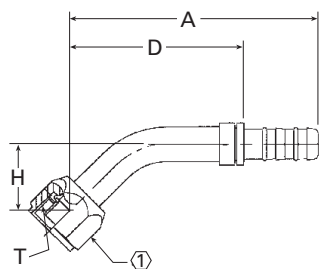

Part number	Th'd "T"	Hose size	A Ref	D Ref	F Ref	H Ref	① Ref
FJ3192-02-1212S	M27x2	12	4.74	3.17	—	1.47	1.25

FJ3111/FJ3409

90° Female O-Ring (long pilot) metric thread

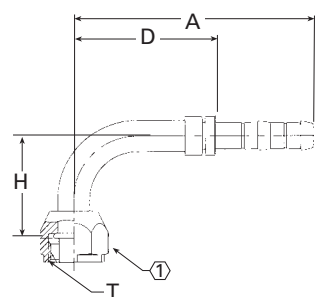

Part number	Th'd "T"	Hose size	A Ref	D Ref	F Ref	H Ref	① Ref
FJ3111-01-0808S	M20 x 1.5	8	3.77	2.23	—	1.62	0.94
FJ3111-02-0810S	M20 x 1.5	10	3.78	2.23	—	1.62	0.94
FJ3111-03-0806S*	M20 x 1.5	6	3.75	2.23	—	1.62	0.94
FJ3409-1210S	M27 x 2	10	4.81	3.25	—	2.56	1.25
FJ3409-1212S	M27 x 2	12	4.74	3.16	—	2.56	1.25

* MTO (made to order)

E-Z Clip system

Fittings

FJ3892

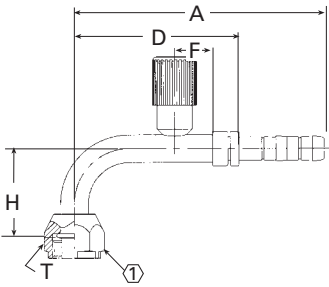

90° Female O-Ring (long pilot) with R134a low side port (metric thread)

Part number	Th'd "T"	Hose size	A Ref	D Ref	F Ref	H Ref	① Ref
FJ3892-01-1010S	M24 x 1.5	10	4.88	3.33	.63	1.89	1.125

FJ3112

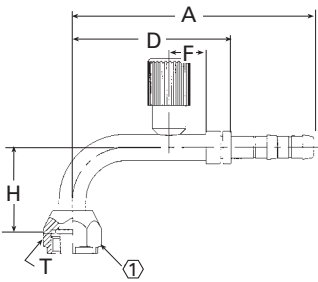

90° Female O-Ring (long pilot) metric thread with high side charge port (R134a)

Part number	Th'd "T"	Hose size	A Ref	D Ref	F Ref	H Ref	① Ref
FJ3112-01-0808S	M20 x 1.5	8	4.52	2.98	0.69	1.62	0.94
FJ3112-02-0810S	M20 x 1.5	10	4.53	2.98	0.69	1.62	0.94
FJ3112-03-0806S	M20 x 1.5	6	4.50	2.98	0.69	1.62	0.94
FJ3112-03-1010S	M24 x 1.5	10	4.88	3.33	0.63	1.89	1.125

FJ3890/FJ3301

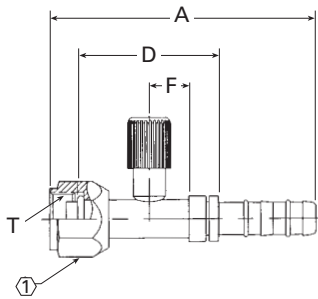

Straight – female O-Ring (long pilot) with R134a high side port (metric thread)

Part number	Th'd "T"	Hose size	A Ref	D Ref	F Ref	H Ref	① Ref
FJ3890-01-0806S	M20 x 1.5	6	4.06	2.16	0.63	—	0.94
FJ3301-01-0606S*	M18 x 1.5	6	3.91	2.10	0.63	—	0.94

* MTO (made to order)

FJ3891

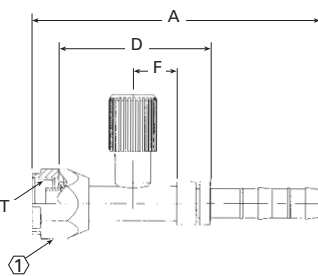

Straight – female O-Ring (long pilot) with R134a low side port (metric thread)

Part number	Th'd "T"	Hose size	A Ref	D Ref	F Ref	H Ref	① Ref
FJ3891-01-1010S	M24 x 1.5	10	4.24	2.25	0.62	1.62	1.125

FJ3113

90° Male O-Ring (rigid) metric thread

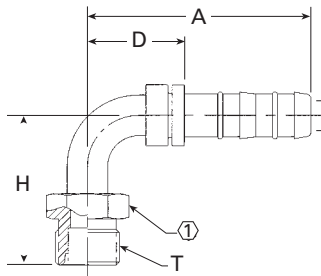

Part number	Th'd "T"	Hose size	A Ref	D Ref	F Ref	H Ref	① Ref
FJ3113-0810S	M20 x 1.5	10	2.75	1.20	—	1.82	0.88

FJ3067/FJ3495

GM tie in – metric tee

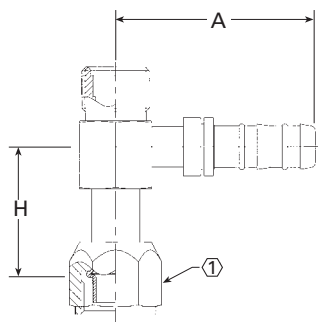

Part number	Th'd "T"	Hose size	A Ref	D Ref	F Ref	H Ref	① Ref
FJ3067-1212S*	M27 x 2	12	3.12	—	—	2.02	1.25
FJ3495-0808S	M20 x 1.5	8	2.71	—	—	1.68	0.94

* MTO (made to order)

EJ3158

Tee style fitting with male O-Ring connection

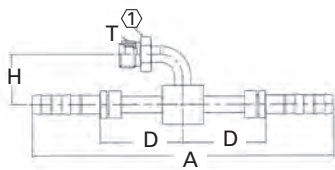

Part number	Th'd "T"	Hose size	A Ref	D Ref	F Ref	H Ref	① Ref
EJ3158-101212S	7/8-14	12	5.67	1.26	—	1.49	0.94
EJ3158-121616S	1-1/16-14	16	6.79	1.72	—	2.13	1.13
EJ3158-060808S	5/8-18	8	6.86	1.88	—	1.14	0.69
EJ3158-080808S	3/4-16	8	6.86	1.89	—	1.39	0.81

FJ3274

Straight – female Rotalok

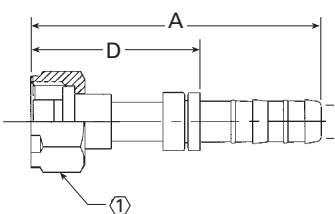

Part number	Th'd "T"	Hose size	A Ref	D Ref	F Ref	H Ref	① Ref
FJ3274-1010S	1-14	10	3.69	2.14	—	—	1.13
FJ3274-1012S*	1-14	12	3.75	2.14	—	—	1.13

* MTO (made to order)

E-Z Clip system

Fittings

FJ3225

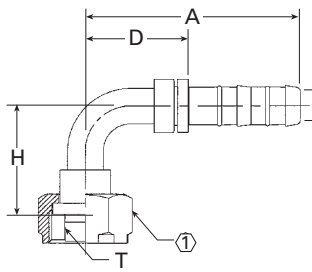

90° Female Rotalok

Part number	Th'd "T"	Hose size	A Ref	D Ref	F Ref	H Ref	① Ref
FJ3225-1010S	1-14	10	2.98	1.43	—	1.52	1.13
FJ3225-1008S	1-14	8	2.98	1.43	—	1.52	1.13
FJ3225-1012S	1-14	12	3.11	1.54	—	1.62	1.13

EJ3321

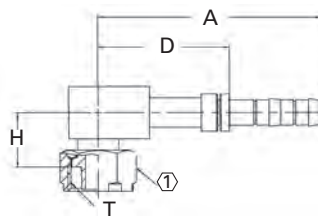

Short drop 90° female Rotalok

Part number	Th'd "T"	Hose size	A Ref	D Ref	F Ref	H Ref	① Ref
EJ3321-1008S	1-14	8	3.62	2.07	—	0.91	1.13
EJ3321-1012S	1-14	12	3.87	2.29	—	0.91	1.13

EJ3421/EJ3422

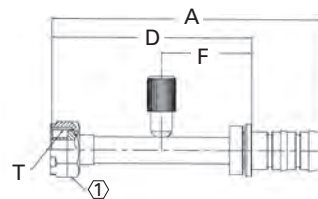

Female Rotalok with R134 port

Part number	Th'd "T"	Hose size	A Ref	D Ref	F Ref	H Ref	① Ref
EJ3421-1012S	1-14	12	6.44	4.86	2.17	High	1.13
EJ3422-1016S	1-14	16	6.45	4.77	2.15	Low	1.13

FJ3510

90° Female Rotalok with R134a low side port

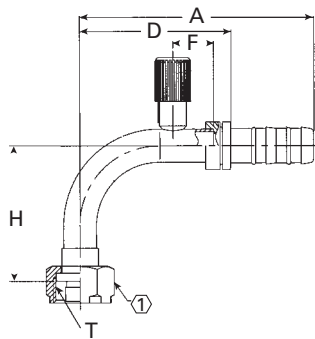

Part number	Th'd "T"	Hose size	A Ref	D Ref	F Ref	H Ref	① Ref
FJ3510-1012S	1-14	12	4.48	2.88	.79	2.58	1.13

FJ3511

90° Female Rotalok with R134a high side port

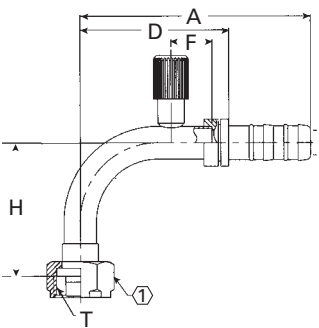

Part number	Th'd "T"	Hose size	A Ref	D Ref	F Ref	H Ref	① Ref
FJ3511-1010S	1-14	10	4.43	2.88	.79	2.58	1.13

FJ3226

90° Female Rotalok with switch port (7/16-20 thread)

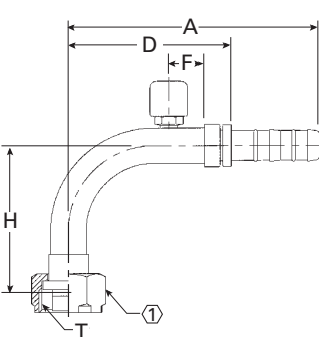

Part number	Th'd "T"	Hose size	A Ref	D Ref	F Ref	H Ref	① Ref
FJ3226-1010S	1-14	10	4.43	2.88	0.63	2.56	1.13

E-Z Clip system

Fittings

FJ3568

90° GM block style

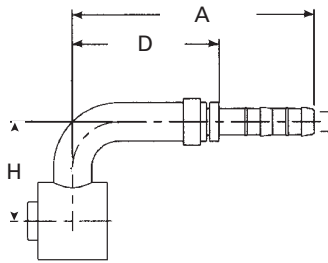

Part number	Th'd "T"	Hose size	A Ref	D Ref	F Ref	H Ref	① Ref
FJ3568-1008S*	—	8	3.92	2.38	—	1.60	—
FJ3568-1010S*	—	10	3.83	2.28	—	2.31	—
FJ3568-1012S*	—	12	3.86	2.28	—	2.38	—

* MTO (made to order)

FJ3513

Straight bulkhead

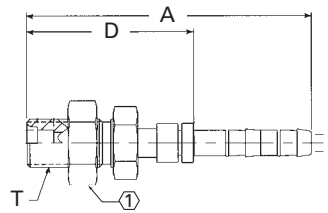

Part number	Th'd "T"	Hose size	A Ref	D Ref	F Ref	H Ref	① Ref
FJ3513-0606S	5/8-18	6	3.69	2.16	—	—	0.94
FJ3513-0808S	3/4-16	8	3.93	2.39	—	—	1.0
FJ3513-1010S	7/8-14	10	4.49	2.94	—	—	1.13
FJ3513-1212S	1-1/16-14	12	4.83	3.24	—	—	1.38
FJ3513-1216S	1-1/16-14	16	4.92	3.24	—	—	1.38

FJ3514

90° Male bulkhead

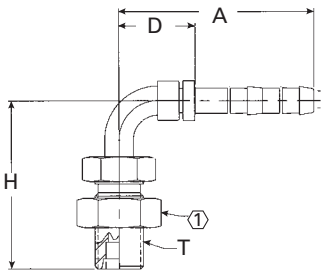

Part number	Th'd "T"	Hose size	A Ref	D Ref	F Ref	H Ref	① Ref
FJ3514-0606S	5/8-18	6	2.50	0.98	—	2.15	0.94
FJ3514-0808S	3/4-16	8	2.74	1.20	—	2.61	1.00
FJ3514-0608S	5/8-18	8	2.52	0.98	—	2.15	0.94
FJ3514-1010S	7/8-14	10	3.08	1.53	—	3.26	1.13
FJ3514-1012S	7/8-14	12	3.11	1.53	—	3.26	1.13
FJ3514-1212S	1-1/16-14	12	3.69	2.11	—	3.78	1.38
FJ3514-1216S	1-1/16-14	16	3.79	2.12	—	3.8	1.06

FJ3045

Straight splicer

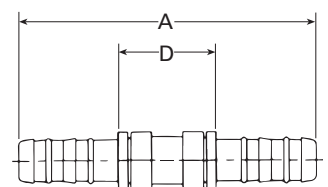

Part number	Th'd "T"	Hose size	A Ref	D Ref	F Ref	H Ref	① Ref
FJ3045-0606S	—	6	4.63	1.58	—	—	—
FJ3045-0808S	—	8	4.76	1.68	—	—	—
FJ3045-1010S	—	10	5.68	2.58	—	—	—
FJ3045-1212S	—	12	4.72	1.57	—	—	—
FJ3045-1008S	—	8	5.78	2.69	—	—	—
FJ3045-1616S	—	16	5.18	1.82	—	—	—

FJ3058

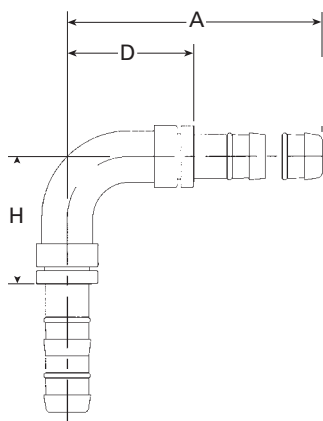

90° Splicer

Part number	Th'd "T"	Hose size	A Ref	D Ref	F Ref	H Ref	Ⓛ Ref
FJ3058-01-0606S	—	6	2.71	1.18	—	2.71	—
FJ3058-02-0808S	—	8	2.98	1.43	—	2.98	—
FJ3058-03-1010S	—	10	3.08	1.53	—	3.08	—
FJ3058-04-1212S	—	12	3.68	2.11	—	3.68	—
FJ3058-05-1010S	—	10	6.86	5.61	—	6.86	—
FJ3058-06-1212S	—	12	6.86	5.36	—	6.86	—

FJ3496

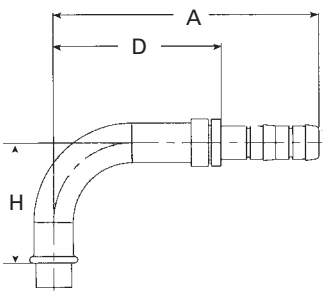

90° Pilot connection (long pilot)

Part number	Th'd "T"	Hose size	A Ref	D Ref	F Ref	H Ref	Ⓛ Ref
FJ3496-01-1010S	—	10	4.22	2.67	—	1.89	—
FJ3496-04-0608S	—	8	3.27	2.23	—	1.62	—
FJ3496-02-0808S*	—	8	3.77	2.23	—	1.62	—
FJ3496-03-1012S	—	12	4.25	2.67	—	1.89	—

* MTO (made to order)

FJ3171

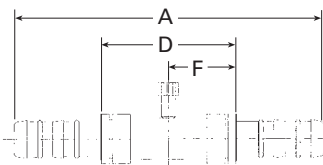

Splicer with switch port (7/16-20 thd)

Part number	Th'd "T"	Hose size	A Ref	D Ref	F Ref	H Ref	Ⓛ Ref
FJ3171-0606S	—	6	5.41	2.36	1.18	—	—
FJ3171-0808S	—	8	5.61	2.52	1.26	—	—
FJ3171-1010S	—	10	5.54	2.44	1.22	—	—
FJ3171-1212S	—	12	5.60	2.44	1.22	—	—
FJ3171-1616S	—	16	6.79	3.44	1.72	—	—

FJ5995

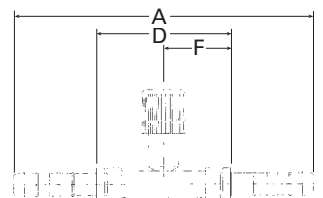

Splicer with high side R134a port

Part number	Th'd "T"	Hose size	A Ref	D Ref	F Ref	H Ref	Ⓛ Ref
FJ5995-0606S	—	6	5.41	2.36	1.18	—	—
FJ5995-0808S	—	8	5.61	2.52	1.26	—	—
FJ5995-1010S	—	10	5.62	2.52	1.26	—	—
FJ5995-1212S	—	12	5.67	2.52	1.26	—	—

* MTO (made to order)

E-Z Clip system

Fittings

FJ5986

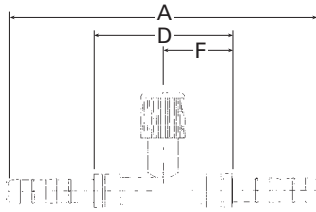

Splicer with R134a low side port

Part number	Th'd "T"	Hose size	A Ref	D Ref	F Ref	H Ref	① Ref
FJ5986-1010S	—	10	5.54	2.44	1.22	—	—
FJ5986-1212S	—	12	5.60	2.44	1.22	—	—
FJ5986-1616S	—	16	6.79	3.44	1.72	—	—

FJ3427

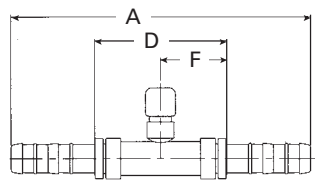

Splicer with high side switch port (M10 X 1.25)

Part number	Th'd "T"	Hose size	A Ref	D Ref	F Ref	H Ref	① Ref
FJ3427-0808S	—	8	5.61	2.52	1.26	—	—
FJ3427-1010S	—	10	5.54	2.44	1.22	—	—

FJ3428

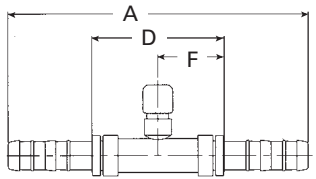

Splicer with low side switch port (M12 X 1.25)

Part number	Th'd "T"	Hose size	A Ref	D Ref	F Ref	H Ref	① Ref
FJ3428-1212S	—	12	5.59	2.44	1.22	—	—
FJ3428-1616S	—	16	6.79	3.44	1.72	—	—

FJ3066

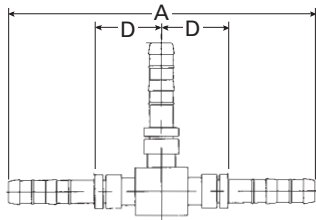

"T" Splicer - 3 hose connector

Part number	Th'd "T"	Hose size	A Ref	D Ref	F Ref	H Ref	① Ref
FJ3066-0606S	—	6	5.48	2.40	—	—	—
FJ3066-0808S	—	8	5.48	2.40	—	—	—
FJ3066-1010S	—	10	5.62	2.52	—	—	—
FJ3066-1212S	—	12	5.67	2.52	—	—	—
FJ3066-1616S	—	16	6.41	3.06	—	—	—
FJ3066-101212S	—	10X12X12	5.67	2.52	—	—	—
FJ3066-060808S	—	6X8X8	5.48	2.40	—	—	—
FJ3066-	—	12X12X16	5.98	2.62	—	—	—
FJ3066-	—	12X16X16	5.98	2.62	—	—	—

* MTO (made to order)

EJ5096

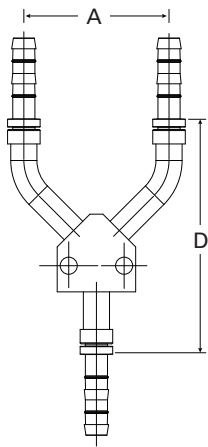

"Y" Splicer - 3 hose connector

Part number	Th'd "T"	Hose size	A Ref	D Ref	F Ref	H Ref	① Ref
EJ5096-080808*	—	8	2.78	4.52	—	—	—
EJ5096-101010*	—	10	2.64	4.39	—	—	—
EJ5096-121212*	—	12	2.64	4.29	—	—	—
EJ5096-101012*	—	10X10X12	2.64	4.29	—	—	—
EJ5096-121216*	—	12X12X16	2.64	4.29	—	—	—

* MTO (made to order)

FJ3623

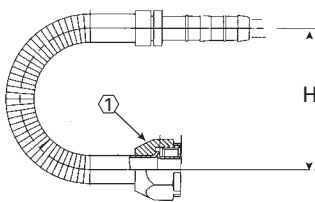

180° Female O-Ring pilot

Part number	Th'd "T"	Hose size	A Ref	D Ref	F Ref	H Ref	① Ref
FJ3623-0808S*	M20 x 1.5	8	—	—	—	2.50	.94

* MTO (made to order)

FJ3624

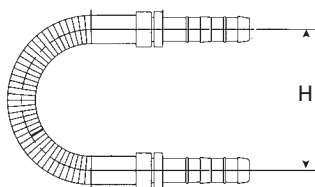

180° Splicer

Part number	Th'd "T"	Hose size	A Ref	D Ref	F Ref	H Ref	① Ref
FJ3624-0808S*	—	8	—	—	—	2.50	—

* MTO (made to order)

FJ3804

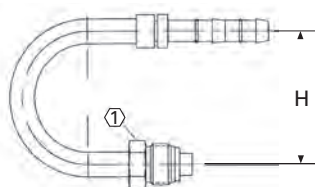

180° Male O-Ring

Part number	Th'd "T"	Hose size	A Ref	D Ref	F Ref	H Ref	① Ref
FJ3804-0606S	5/8-18	6	—	—	—	2.00	0.625
FJ3804-1010S	7/8-18	10	—	—	—	3.00	0.88
FJ3804-1012S	7/8-18	12	—	—	—	3.00	0.88

E-Z Clip system

Fittings

FJ3914

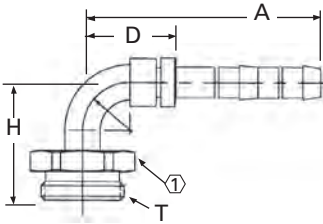

90° 5400 coupling thread

Part number	Th'd "T"	Hose size	A Ref	D Ref	F Ref	H Ref	① Ref
FJ3914-03-1210S	1-1/4-18	10	3.08	1.53	—	1.73	1.38
FJ3914-04-0806S	7/8-20	6	2.50	0.98	—	1.23	1.00
FJ3914-02-1212S*	1-1/4-18	12	3.08	1.53	—	1.73	1.38

* MTO (made to order)

FJ3970

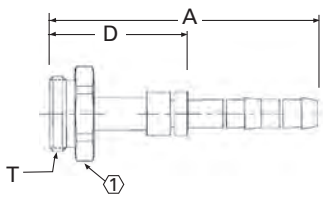

Straight 5400 coupling thread

Part number	Th'd "T"	Hose size	A Ref	D Ref	F Ref	H Ref	① Ref
FJ3970-0606S	7/8-20	6	3.14	1.82	—	—	1.00
FJ3970-0808S	7/8-20	8	3.19	1.65	—	—	1.00
FJ3970-1212S	1-1/4-18	12	3.50	1.93	—	—	1.38
FJ3970-1616S	1-19/32-20	16	3.66	1.98	—	—	1.75

FJ3734



Female O-Ring (long pilot) compound tube

Part number	Th'd "T"	Hose size	A Ref	D Ref	F Ref	H Ref	① Ref
FJ3734-1212S*	1 1/16 x 14	12	—	—	—	—	1.25

* MTO (made to order)

FJ3801

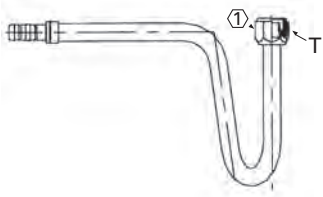

Female O-Ring (long pilot) compound tube

Part number	Th'd "T"	Hose size	A Ref	D Ref	F Ref	H Ref	① Ref
FJ3801-1212S*	1 1/16 x 14	12	—	—	—	—	1.25

* MTO (made to order)

FJ3977

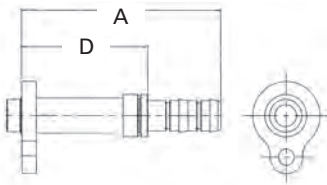

Pad style connection (Volvo)

Part number	Th'd "T"	Hose size	A Ref	D Ref	F Ref	H Ref	① Ref
FJ3977-0806S	—	6	3.34	1.82	—	—	—
FJ3977-0810S	—	10	3.74	2.19	—	—	—
FJ3977-1012S	—	12	4.32	2.73	—	—	—

FJ3982

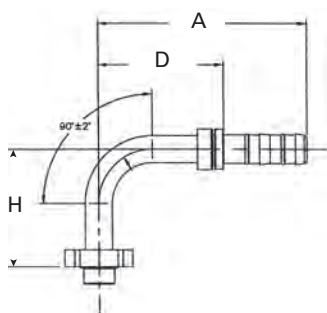

90° Pad style connection (Volvo)

Part number	Th'd "T"	Hose size	A Ref	D Ref	F Ref	H Ref	① Ref
FJ3982-0806S	—	6	3.86	2.33	—	2.18	—
FJ3982-0810S	—	10	3.86	2.31	—	2.18	—

FJ3983

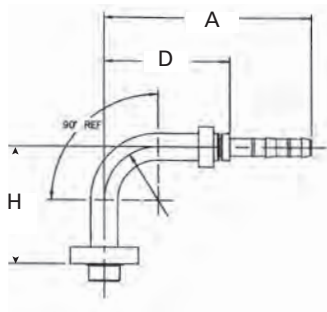

90° Pad style connection (Volvo) (pad orientation 90°)

Part number	Th'd "T"	Hose size	A Ref	D Ref	F Ref	H Ref	① Ref
FJ3983-0806S	—	6	3.86	2.33	—	2.18	—

FJ3980

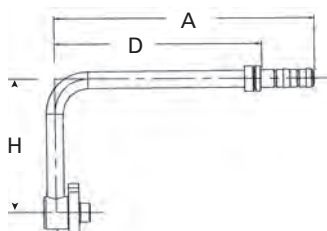

180° Pad style connection

Part number	Th'd "T"	Hose size	A Ref	D Ref	F Ref	H Ref	① Ref
FJ3980-0810S*	—	10	6.04	4.48	—	3.92	—

* MTO (made to order)

E-Z Clip system

Fittings

FJ3978

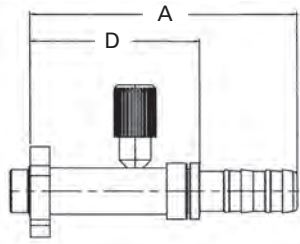

Straight pad style (Volvo) with R134a low side port

Part number	Th'd "T"	Hose size	A Ref	D Ref	F Ref	H Ref	① Ref
FJ3978-1012S*	—	12	4.32	2.73	—	—	—

* MTO (made to order)

FJ3979

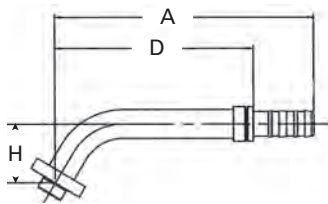

60° Elbow, pad style (Volvo) with R134a low side port

Part number	Th'd "T"	Hose size	A Ref	D Ref	F Ref	H Ref	① Ref
FJ3979-1012S	—	12	6.78	5.2	—	1.53	—

FJ3981

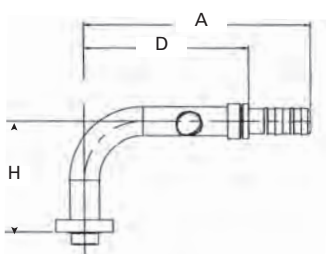

90° Elbow, pad style (Volvo) with R134a low side port

Part number	Th'd "T"	Hose size	A Ref	D Ref	F Ref	H Ref	① Ref
FJ3981-1012S	—	12	5.9	4.32	—	2.84	—

IF20340

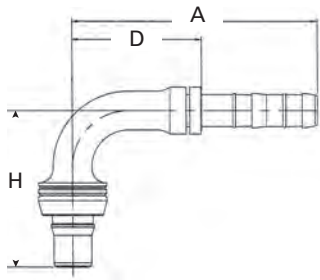

90° to STC

Part number	Th'd "T"	Hose size	A Ref	D Ref	F Ref	H Ref	Ⓜ Ref
1F20340-0808-S	—	8	3.03	1.49	—	2.09	—

EJ3809

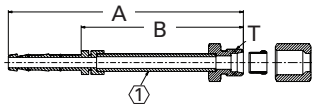

E-Z Clip compression fitting

Part number	Th'd "T"	Hose size	A Ref	D Ref	F Ref	H Ref	Ⓜ Ref
EJ3809-11-0506S	1/2-20	6	4.91	3.38	—	—	0.69
EJ3809-01-0606S	9/16-18	6	4.92	3.40	—	—	0.69
EJ3809-02-0806S	3/4-16	6	4.93	3.40	—	—	0.88
EJ3809-03-0608S	9/16-18	6	4.94	3.40	—	—	0.69
EJ3809-04-0808S	3/4-16	8	4.84	3.30	—	—	0.88
EJ3809-05-1008S	7/8-14	8	4.73	3.19	—	—	1.00
EJ3809-06-0810S	3/4-16	10	4.85	3.30	—	—	0.88
EJ3809-07-1010S	7/8-14	10	4.64	3.09	—	—	1.00
EJ3809-08-1012S	7/8-14	12	4.66	3.09	—	—	1.00
EJ3809-09-1212S	1-1/16-12	12	4.98	3.40	—	—	1.25
EJ3809-10-1210S	1-1/16-12	10	5.05	3.50	—	—	1.25

GA23854

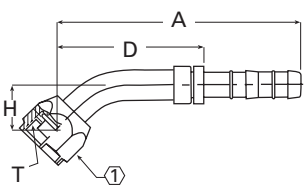

45° Female O-Ring (long pilot)

Part number	Th'd "T"	Hose size	A Ref	D Ref	F Ref	H Ref	Ⓜ Ref
GA23854-12-16*	1 1/16-14	16	5.125	3.175	—	1.39	32mm

* MTO (made to order)

E-Z Clip system

Fittings

GA24335

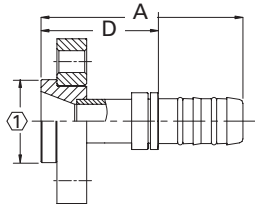

Straight Bock compressor fitting

Part number	Th'd "T"	Hose size	A Ref	D Ref	F Ref	H Ref	① Ref
GA24335-16-12	—	12	4	2.42	—	—	1.65
GA24335-22-16	—	16	4.01	2.33	—	—	1.65

GA24336

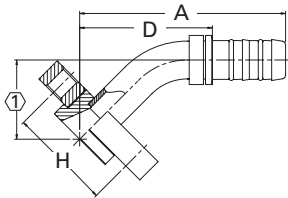

45° Bock compressor fitting

Part number	Th'd "T"	Hose size	A Ref	D Ref	F Ref	H Ref	① Ref
GA24336-16-12	—	12	4.85	3.27	—	1.65	1.53
GA24336-22-16	—	16	4.72	3.04	—	1.65	1.81

GA24337

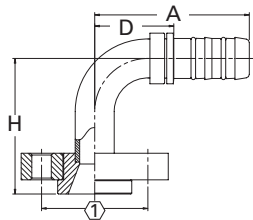

90° Bock compressor fitting

Part number	Th'd "T"	Hose size	A Ref	D Ref	F Ref	H Ref	① Ref
GA24337-16-12	—	12	3.65	2.07	—	2.50	1.65
GA24337-22-16	—	16	3.44	1.76	—	3.01	1.65

Cages, clips and Lifesavers

Cages

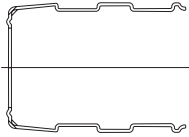

Part number	Cage size	Hose description
1F40105-06C	-06	Cages for size -06 hose
1F40105-08C	-08	Cages for size -08 hose
1F40105-10C	-10	Cages for size -10 hose
1F40105-12C	-12	Cages for size -12 hose
1F40105-16C	-16	Cages for size -16 hose

Clips

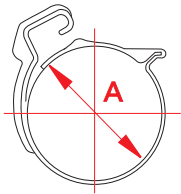

Part number	A Ref	Description
1F40104-06C	18.0 mm	Clips for size -06 hose
1F40104-08C	20.5 mm	Clips for size -08 hose
1F40104-10C	23.0 mm	Clips for size -10 hose
1F40104-12C	27.5 mm	Clips for size -12 hose
1F40104-16C	33.0 mm	Clips for size -16 hose

Clip and cage kits

Kit part number	Hose size	Number of clips per kit	Number of cages per kit
FF14171	6	2	1
FF14172	8	2	1
FF14173	10	2	1
FF14174	12	2	1
FF14401	16	2	1
FF13819	6	4	2
FF13820	8	4	2
FF13821	10	4	2
FF13822	12	4	2
FF14402	16	4	2

Lifesaver braze nipple

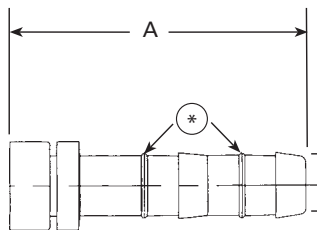

Part number	Th'd "T"	Hose size	A Ref
FF12262-0606	—	6	2.01
FF12262-0608	—	8	2.02
FF12262-0808	—	8	2.02
FF12262-0810	—	10	2.03
FF12262-1010	—	10	2.03
FF12262-1012	—	12	2.06
FF12262-1212	—	12	2.21
FF12262-1616	—	16	2.21
FF12262-1016	—	16	2.21
FF12262-1216	—	16	2.21
FF12262-1616	—	16	2.21



* O-Rings packaged separately

E-Z Clip system

Aluminum Lifesaver

Aluminum Lifesaver



A/C hose repair system

The Aluminum Lifesaver braze fitting is designed to rework failed OEM aluminum air conditioning tubing and hose assemblies in sizes 10mm to 18mm (metric tubing only, -6 to -12).

This repair system allows the installer to reuse unique OEM terminal connections, while replacing the failed OEM hose and nipple with the E-Z Clip attachment system.

Note: The E-Z Clip system can only be used with Eaton GH001 hose.

E-Z to use

Each kit contains the correct components for replacement of a single hose assembly.

Eaton GH001 hose must be ordered or purchased separately.

Determine tube O.D. for Hose I.D. per chart below:

Standard configurations

Size* kit	Tube O.D.	Hose I.D.	Hose Part number	Use Lifesaver Part number
-6	10 (.39)	8 (.32)	GH001-6WR	FF13727-1006
-8	12 (.47)	11 (.42)	GH001-8WR	FF13727-1208
-10	16 (.63)	13 (.51)	GH001-10WR	FF13727-1610
-12	18 (.71)	16 (.64)	GH001-12WR	FF13727-1812

*This (-) size label will be referenced throughout the instructions

E-Z Clip Aluminum Lifesaver kits

FF13727

Part number ordering guide

Order kit no.	Kit component	Description	Qty
FF13727-size	GW1172-size	Braze-on nipple	2
	1F40106-size	Nipple O-Ring	5
	GA7000579-size	Silver braze ring	3
		Assembly instructions	1

E-Z Clip tools and Tool case



E-Z Clip Tool case FF12139

Kit contents components

part number	Description	Qty/per kit
1F40104-size	Clips	20
1F40105-size	Cages	10
FT1357	Assembly tool	1
FT1356	Hose cutter	1
FT1356-2-1	Replacement blade	1

The E-Z Clip system has been designed to work exclusively with Eaton GH001 hose.

Pliers/connecting assembly tool



FT1357

E-Z Clip Pliers/connecting tool FT1357 & FT1421

Part number

Description

FT1357	Connecting tool
FT1421	Connecting tool for #16

(Replaces FT1417)



FT1421

Hose cutter



FT1356

Hose cutter FT1356

Part number

Description

FT1356	Hose cutter
FT1356-2-1	Replacement blade

Core tool

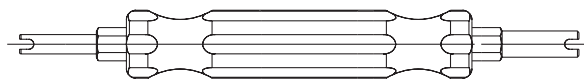

FT1406
Core Tool

Core tool FT1406

Part number

Description

FT1406	Core tool
FF90192-02	High side core*
FF90192-01	Low side core*
FF90193-02	High side cap for M10 x .75 thd. port
FF90193-01	Low side cap for M8 x 1.0 thd. port
FF9872-04	Cap for 7/16-20 thd.port

*For high flow charge ports only.



FF90192-02
High Side Core



FF90192-01
Low Side Core*



FF90193-02 High Side Cap
FF90193-01 Low Side Cap



FF9872-04
Cap

E-Z Clip system

Clip components – Ordering & identifying

E-Z Clip components – Ordering & identifying

The E-Z Clip System is designed for assembly with Eaton GH001 multi-refrigerant hose. Its engineered connection exceeds SAE J2064 and has been vibration and impulse tested.

The benefits of E-Z Clip are virtually endless:

- No guess work
- No leaking crimps
- No power supply needed
- As easy to use as a pair of pliers
- Easy to use in confined areas

Assembly materials checklist

- Pliers (FT1357)
- Guillotine blade (FT1356) or equivalent cutting tool
- Refrigerant oil compatible with refrigeration or A/C system
- GH001 multi-refrigerant hose
- Nipple assembly*
- Appropriately sized clips and cage

*The two black O-Rings on the nipple assembly are of a specific rubber compound and size. They should NOT be removed.



Assembly materials

E-Z Clip System components are simple to identify, order and use

Ordering information

Hose	Nipple	Cage	Clips
GH001-6WR	FJ___-__06S	1F40105-06C	1F40104-06C
GH001-8WR	FJ___-__08S	1F40105-08C	1F40104-08C
GH001-10WR	FJ___-__10S	1F40105-10C	1F40104-10C
GH001-12WR	FJ___-__12S	1F40105-12C	1F40104-12C
GH001-16WR*	FJ___-__16S	1F40105-16C	1F40104-16C

Identification guide

Hose	Cage	Clips	Nipple O-Ring*(HNBR)
GH001-6WR	-6 and 150	150	1F40106-06
GH001-8WR	-8 and 175	175	1F40106-08
GH001-10WR	-10 and 200	200	1F40106-10
GH001-12WR	-12 and 245	245	1F40106-12
GH001-16WR	-16 and 285	285	1F40106-16

For example...



Hose

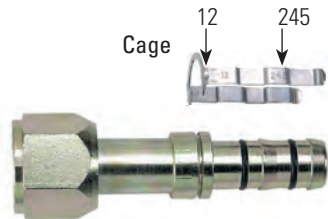

Cage groove



Clips

E-Z Clip assembly instructions

Step 1. Cut the hose

Cut the hose to proper length with an appropriate cutting tool. The hand-held hose cutter (FT1356) has been specifically designed for cutting all non-wire reinforced hose, such as GH001 multi-refrigerant hose. Be sure the cut is made square to the hose length.



Step 2. Slip on two clips

Install two proper-sized clips onto the cut end of the hose. Orientation of the clips does not affect the performance of the connection. However, for ease of assembly, both clips should have the same orientation.

Note: Failure to slide the clips over the hose at this time will require the clips to be stretched over the hose or fitting later. This may permanently damage the clip.



Step 3. Oil the nipple

Lubricate the nipple with a generous amount of the refrigeration or A/C system's compressor lubricating oil. This **MUST** be done to lower the force of nipple insertion.



Step 4. Insert the nipple into the hose

To ensure that the nipple is fully inserted, check the gap between the cut end of the hose and the shoulder on the nipple. Care should be taken to avoid kinking or other damage to the hose during nipple insertion.

Note: Be sure to wipe excess oil from the nipple and hose.



Step 5. Snap on the cage

Snap the cage into the groove on the nipple. The arms should extend over the hose length. When the cage has been correctly installed in the cage groove, the cage will be able to rotate in the groove. This step **MUST** be performed to ensure:

1. The clips will be located over the O-Rings on the nipple.
2. The connection will be compatible with the connection's pressure rating.



E-Z Clip system

Assembly instructions

E-Z Clip Assembly instructions (Continued)

Step 6: Slide the clips

Slide the clips over the cage arms and into the channels on each arm.

Step 7: Close the clips

Use the FT1357 pliers to close the clips. The pliers should be positioned squarely on the clip connection points and should remain square during the closing of the clip.

The nose of the pliers should be firmly seated under the assembly bump and lock latch.

For easiest assembly, the clasp should be closed between the cage arms. If the pliers are not kept square during closing of the clip, the clasp may have an offset. Use the pliers to correct the clasp alignment.

Notice: E-Z Clip components should not be reused.

CAUTION

Failure to follow these assembly instructions and/or the use of Weatherhead hose with fittings supplied by other manufacturers may result in unreliable and unsafe hose assemblies, which may result in sudden or unintended escape of refrigerant gases. Personal injury and/or violations of EPA regulations may occur as a consequence.

Eaton recommends adherence to all guidelines, including EPA guidelines, concerning the service of refrigerant systems.



For easiest assembly, the clasp should be closed between the cage arms.

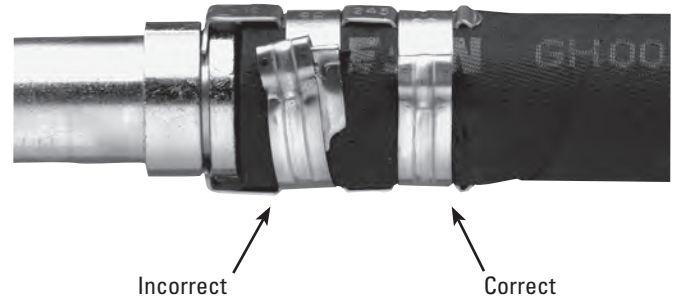
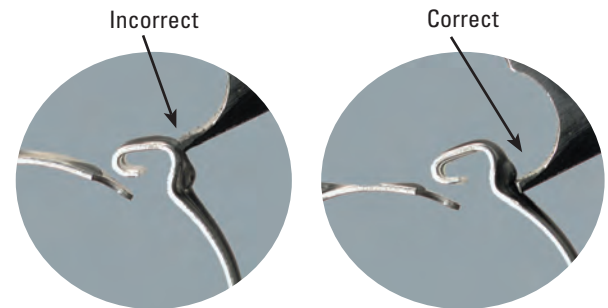

Steel adapters

Application data

How to identify fluid connectors	J-2
Thread size chart	J-3
How to measure non-thread connectors	J-4
Connections	
American connections	J-4
ISO Connections	J-7
German connections	J-9
French connections	J-12
British connections	J-12
Japanese connections	J-13
Thread engagement nominal dimensions	J-16
Pressure performance	
SAE Thread style	J-18
All Eaton	J-19
Tubing Applications	
Maximum operating pressures	J-20
Recommended wall thickness	J-21
Assembly torque	
Recommended parallel connection	J-22
Assembly instructions	
ORS, pipe threads and SAE 37° tube fittings	J-24
Adjustable SAE O-Ring boss	J-26
How to order adapters	J-27

Adapters

Configuration index	J-29
ORS connections	J-39
ORS-TF	J-40
ORS-Braze type	J-41
ORS/SAE O-Ring boss	J-44

ORS-NPTF	J-49
ORS to SAE 37° flare	J-51
ORS/ORS	J-52
ORS accessories	J-56
SAE O-Ring boss/SAE O-Ring boss	J-58
Pipe to pipe	J-61
Pipe to SAE 37° flare	J-77
Pipe to 45° flare	J-89
Pipe to SAE O-Ring boss	J-91
Pipe to braze and weld	J-94
SAE 37° flare union	J-94
SAE 45° flare union	J-103
SAE O-Ring boss to SAE 37° flare	J-104
Split flange O-Ring and kits	J-109
SAE split flange to ORS	J-114
SAE split flange to SAE 37° flare	J-116
SAE swivel flange to SAE split flange	J-119
SAE flareless to SAE 37° union	J-120
Braze and weld to split flange	J-121
Braze and weld to SAE 37° flare	J-123
Versil-Flare™ – flareless and flared	J-124
Specials	J-128
Metric thread dimensions	J-130
Metric to SAE 37° flare	J-131
ORS to metric	J-134
Pipe to metric	J-135
BSPP to SAE 37° flare	J-136
BSPT to SAE 37° flare	J-137
JIS 30° to SAE 37° flare	J-138
7000 series Ermeto	J-139
Cross reference index	J-153

J



Steel adapters

Fluid connectors identification

Fluid connectors identification

Measuring Tools: A seat angle gauge, thread pitch gauge and an I.D./O.D. caliper are necessary to make accurate measurements of commonly used connectors. Eaton offers a unique new caliper than offers the capabilities of both a caliper and a seat angle gauge in one unit.



FT1341

Identification Tool Kit

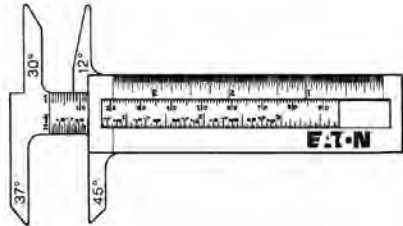

I.D./O.D. Angle gauge caliper

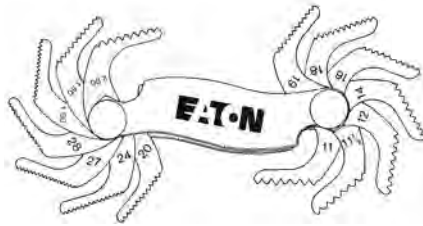

Thread pitch gauge

How to measure threads

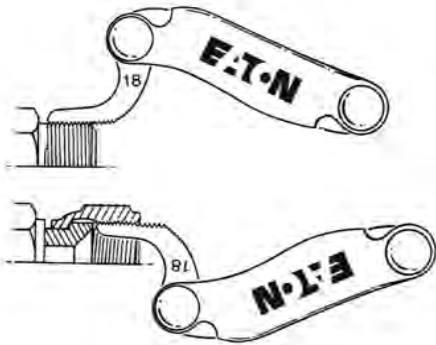

Use a thread pitch gauge to determine the number of threads per inch or the distance between threads in metric connections. Place the gauge on the threads until the fit is snug. Match the measurement to the charts.

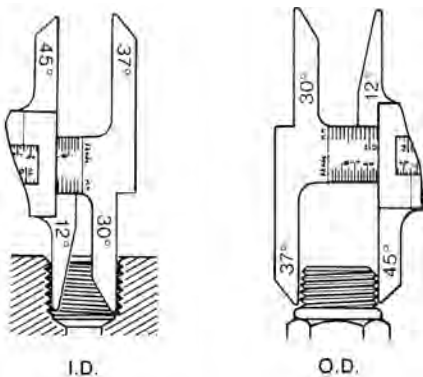

Measure the thread diameter with an I.D./O.D. caliper as shown. Match the measurements to the charts.

How to measure sealing surface angles

Female connections are usually measured by inserting the gauge into the connection and placing it on the sealing surface. If the centerlines of the connection and gauge are parallel, the correct angle has been determined.

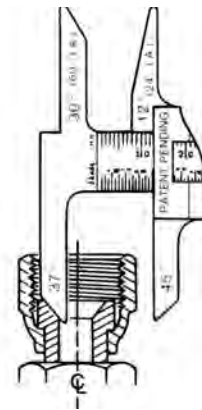

Male flare type connectors are usually measured by placing the gauge on the sealing surface. If the centerlines of the connection and gauge are parallel, the correct angle has been determined.

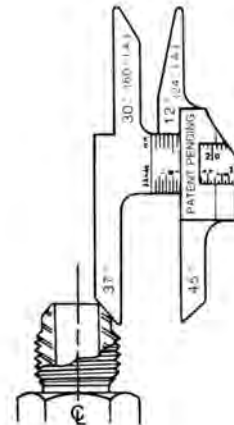

Thread size chart

The following chart is intended as a quick reference guide for thread size by dash size.

Dash size	N.P.T.F.		N.P.S.M. approx. dia.		SAE 45° auto. refriger.		SAE 37° (J.I.C.) hydraulic		SAE O-Ring boss		P.T.T. 30° automotive		SAE invert. flare		ORS	
-02	1/8-27	1/8-27	1/8-27	1/8-27	5/16-24	5/16-24	5/16-24	5/16-24	5/16-24	-	5/16-24	-	5/16-24	-	-	-
-03	-	-	-	-	3/8-24	3/8-24	3/8-24	3/8-24	3/8-24	-	3/8-24	-	3/8-24	-	-	-
-04	1/4-18	1/4-18	1/4-18	1/4-18	7/16-20	7/16-20	7/16-20	7/16-20	7/16-20	-	7/16-24	-	7/16-24	9/16-18	-	-
-05	-	-	-	-	1/2-20	1/2-20	1/2-20	1/2-20	1/2-20	-	1/2-20	-	1/2-20	-	-	-
-06	3/8-18	3/8-18	3/8-18	3/8-18	5/8-18	9/16-18	9/16-18	9/16-18	9/16-18	-	5/8-18	-	5/8-18	11/16-16	-	-
-07	-	-	-	-	11/16-24	-	-	-	-	-	11/16-18	-	11/16-18	-	-	-
-08	1/2-14	1/2-14	1/2-14	1/2-14	3/4-16	3/4-16	3/4-16	3/4-16	3/4-16	-	3/4-18	-	3/4-18	13/16-16	-	-
-10	-	-	-	-	7/8-14	7/8-14	7/8-14	7/8-14	7/8-14	-	7/8-18	-	7/8-18	1-14	-	-
-12	3/4-14	3/4-14	3/4-14	3/4-14	1 1/16-14	1 1/16-12	1 1/16-12	1 1/16-12	1 1/16-12	-	1 1/16-16	-	1 1/16-16	1 3/16-12	-	-
-14	-	-	-	-	-	1 3/16-12	1 3/16-12	1 3/16-12	1 3/16-12	-	-	-	-	-	-	-
-16	1-11 1/2	1-11 1/2	1-11 1/2	1-11 1/2	-	1 5/16-12	1 5/16-12	1 5/16-12	1 5/16-12	1 5/16-14	-	1 5/16-14	-	1 7/16-12	-	-
-20	1 1/4-11 1/2	1 1/4-11 1/2	1 1/4-11 1/2	1 1/4-11 1/2	-	1 5/8-12	1 5/8-12	1 5/8-12	1 5/8-12	1 5/8-14	-	1 5/8-14	-	1 11/16-12	-	-
-24	1 1/2-11 1/2	1 1/2-11 1/2	1 1/2-11 1/2	1 1/2-11 1/2	-	1 7/8-12	1 7/8-12	1 7/8-12	1 7/8-12	1 7/8-14	-	1 7/8-14	-	2-12	-	-
-32	2-11 1/2	2-11 1/2	2-11 1/2	2-11 1/2	-	2 1/2-12	2 1/2-12	2 1/2-12	2 1/2-12	2 1/2-12	-	2 1/2-12	-	-	-	-
-40	2 1/2-8	2 1/2-8	2 1/2-8	2 1/2-8	-	3-12	3-12	3-12	3-12	-	-	-	-	-	-	-
-48	3-8	3-8	3-8	3-8	-	3 1/2-12	3 1/2-12	3 1/2-12	3 1/2-12	-	-	-	-	-	-	-

Through hole dimensions

All dimensions are nominal. In jump size bodies, the minimum through hole dimensions will correspond to the smallest dash size.

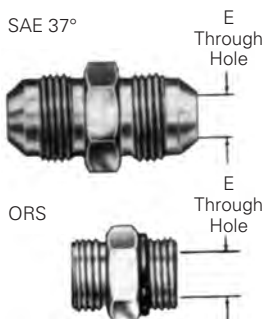

Dash size	E through hole			
	SAE 37°		ORS	
	mm	in	mm	in
-03	3,0	0.12	-	-
-04	4,3	0.17	4,3	0.17
-05	5,8	0.23	-	-
-06	7,6	0.30	6,6	0.26
-08	9,9	0.39	9,7	0.38
-10	12,2	0.48	12,2	0.48
-12	15,5	0.61	15,5	0.61
-16	21,3	0.84	20,6	0.81
-20	25,8	1.08	26,1	1.03
-24	33,3	1.31	32,0	1.26
-32	45,2	1.78	-	-

Steel adapters

Non-threaded connections, American connections

J

How to measure non-threaded connections

Four bolt flange

First measure the port hole diameter using the caliper. Next, measure the longest bolt hole spacing from center-to-center or measure the flange head diameter.

Staplok

Measure the male diameter with the O.D. portion of the caliper. Measure the female half by inserting the I.D. portion of the caliper into the through hole.

Dash numbers

Most fluid piping system sizes in the United States are measured by dash numbers. These are universally used abbreviations for the size of the component expressed as the numerator of the fraction

with the denominator always being 16. For example, a -04 port is 4/16 or 1/4-inch. Dash numbers are usually nominal (in name only) and are abbreviations that make ordering of components easier.

American connections

NPTF (National pipe tapered fuel)

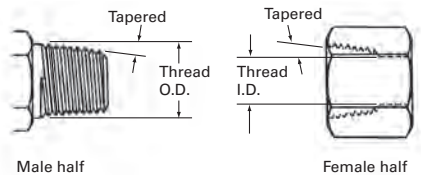

This connection is still widely used in fluid power systems, even though it is not recommended by the National Fluid Power Association (NFPA) for use in hydraulic

applications. The thread is tapered and the seal takes place by deformation of the threads.

NPSM (National pipe straight mechanical)

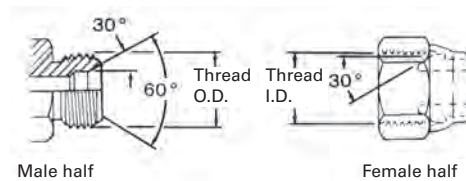

This connection is sometimes used in fluid power systems. The female half has a straight thread and an inverted 30° seat. The male half of the connection has a straight thread and a 30° internal chamfer. The seal takes place by compression of the 30°

seat on the chamfer. The threads hold the connection mechanically.

Note: A properly chamfered NPTF male will also seal with the NPSM female.

NPTF threads

Measure thread diameter and subtract 1/4-inch to find the nominal pipe size.

Inch size	Dash size.	Nominal thread size	Male thread O.D. inch		Female thread I.D. inch	
			Fract.	Dec.	Fract.	Dec.
1/8	02	1/8-27	13/32	0.41	3/8	0.38
1/4	04	1/4-18	17/32	0.54	1/2	0.49
3/8	06	3/8-18	11/16	0.68	5/8	0.63
1/2	08	1/2-14	27/32	0.84	25/32	0.77
3/4	12	3/4-14	1 1/16	1.05	1	0.98
1	16	1-11 1/2	1 5/16	1.32	1 1/4	1.24
1 1/4	20	1 1/4-11 1/2	1 21/32	1.66	1 19/32	0.58
1 1/2	24	1 1/2-11 1/2	1 29/32	1.90	1 13/16	1.82
2	32	2-11 1/2	2 3/8	2.38	2 5/16	2.30

NPSM threads

Inch size	Dash size.	Nominal thread size	Male thread O.D. inch		Female thread I.D. inch	
			Fract.	Dec.	Fract.	Dec.
1/8	02	1/8-27	13/32	0.41	3/8	0.38
1/4	04	1/4-18	17/32	0.54	1/2	0.49
3/8	06	3/8-18	11/16	0.68	5/8	0.63
1/2	08	1/2-14	27/32	0.84	25/32	0.77
3/4	12	3/4-14	1 1/16	1.05	1	0.98
1	16	1-11 1/2	1 5/16	1.32	1 1/4	1.24
1 1/4	20	1 1/4-11 1/2	1 21/32	1.66	1 19/32	0.58
1 1/2	24	1 1/2-11 1/2	1 29/32	1.90	1 13/16	1.82
2	32	2-11 1/2	2 3/8	2.38	2 5/16	2.30

American connections

SAE J1926 straight thread O-Ring boss (ORB)

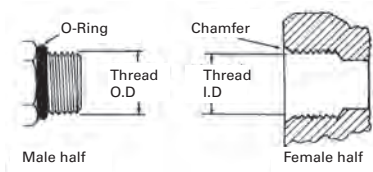

This port connection is recommended by the NFPA for optimum leakage control in medium and high pressure hydraulic systems. The male connector has a straight thread and an O-Ring. The female port has a straight

thread, a machined surface (minimum spotface) and a chamfer to accept the O-Ring. The seal takes place by compressing the O-Ring into the chamfer. The threads hold the connection mechanically.

Inch size	Dash size.	Nominal thread size	Male thread O.D. inch		Female thread I.D. inch	
			Fract.	Dec.	Fract.	Dec.
1/8	02	5/16-24	5/16	0.31	9/32	0.27
3/16	03	3/8-24	3/8	0.38	11/32	0.34
1/4	04	7/16-20	7/16	0.44	13/32	0.39
5/16	05	1/2-20	1/2	0.50	15/32	0.45
3/8	06	9/16-18	9/16	0.56	17/32	0.51
1/2	08	3/4-16	3/4	0.75	3/4	0.69
5/8	10	7/8-14	7/8	0.88	13/16	0.81
3/4	12	1 1/16-12	1 1/16	1.06	1	0.98
7/8	14	1 3/16-12	1 3/16	1.19	1 1/8	1.13
1	16	1 5/16-12	1 5/16	1.31	1 1/4	1.23
1 1/4	20	1 5/8-12	1 5/8	1.63	1 9/16	1.54
1 1/2	24	1 7/8-12	1 7/8	1.88	1 13/16	1.79
2	32	2 1/2-12	2 1/2	2.50	2 7/16	2.42

SAE 37° J514 hydraulic

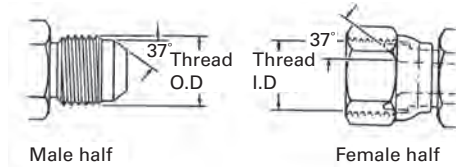

This connection is very common in fluid power systems. Both the male and female halves of the connections have SAE 37° seats. The seal takes place by establishing a line contact between the male flare and the female cone seat. The

threads hold the connection mechanically.

Caution: In the -02, -03, -04, -05, -08 and -10 sizes, the threads of the SAE 45° flare and the SAE 37° flare are the same. However, the sealing surface angles are not the same.

Inch size	Dash size.	Nominal thread size	Male thread O.D. inch		Female thread I.D. inch	
			Fract.	Dec.	Fract.	Dec.
1/8	02	5/16-24	5/16	0.31	9/32	0.27
3/16	03	3/8-24	3/8	0.38	11/32	0.34
1/4	04	7/16-20	7/16	0.44	13/32	0.39
5/16	05	1/2-20	1/2	0.50	15/32	0.45
3/8	06	9/16-18	9/16	0.56	17/32	0.51
1/2	08	3/4-16	3/4	0.75	3/4	0.69
5/8	10	7/8-14	7/8	0.88	13/16	0.81
3/4	12	1 1/16-12	1 1/16	1.06	1	0.98
7/8	14	1 3/16-12	1 3/16	1.19	1 1/8	1.13
1	16	1 5/16-12	1 5/16	1.31	1 1/4	1.23
1 1/4	20	1 5/8-12	1 5/8	1.63	1 9/16	1.54
1 1/2	24	1 7/8-12	1 7/8	1.88	1 13/16	1.79
2	32	2 1/2-12	2 1/2	2.50	2 7/16	2.42

ORS SAE J1453 O-Ring face seal

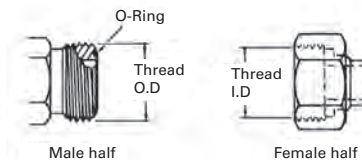

This connection offers the very best leakage control available today. The male connector has a straight thread and an O-Ring in the face. The female has a straight thread and a machined flat face.

The seal takes place by compressing the O-Ring onto the flat face of the female, similar to the split flange type fitting. The threads hold the connection mechanically.

Inch size	Dash size.	Nominal thread size	Male thread O.D. inch		Female thread I.D. inch	
			Fraction	Decimal	Fraction	Decimal
1/4	04	9/16-18	9/16	0.56	17/32	0.51
3/8	06	11/16-16	11/16	0.69	5/8	0.63
1/2	08	13/16-16	13/16	0.82	3/4	0.75
5/8	10	1-14	1	1.00	15/16	0.93
3/4	12	1 3/16-12	1 3/16	1.19	1 1/8	1.11
1	16	1 7/16-12	1 7/16	1.44	1 3/8	1.36
1 1/4	20	1 11/16-12	1 11/16	1.69	1 5/8	1.61
1 1/2	24	2-12	2	2.00	1 15/16	1.92

Steel adapters

American connections

American connections

SAE J512 inverted flare

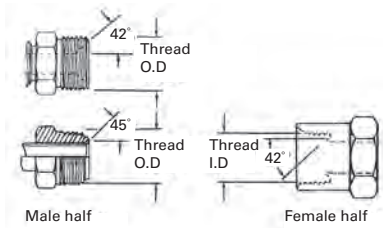

This connection is frequently used in automotive systems. The male connector can either be a 45° flare in the tube fitting form or a 42° seat in the machined adapter form.

The female has a straight thread with a 42° inverted flare. The seal takes place on the flared surfaces. The threads hold the connection mechanically.

Inch size	Dash size	Nominal thread size	Male thread O.D. inch		Female thread I.D. inch	
			Fract.	Dec.	Fract.	Dec.
1/8	02	5/16-24	5/16	0.32	9/32	0.28
3/16	03	3/8-24	3/8	0.38	11/32	0.34
1/4	04	7/16-24	7/16	0.44	13/32	0.40
5/16	05	1/2-20	1/2	0.50	15/32	0.45
3/8	06	5/8-18	5/8	0.63	9/16	0.57
7/16	07	11/16-18	11/16	0.69	5/8	0.63
1/2	08	3/4-18	3/4	0.75	23/32	0.70
5/8	10	7/8-18	7/8	0.88	13/16	0.82
3/4	12	1 1/16-16	1 1/16	1.06	1	1.00

SAE J512 45°

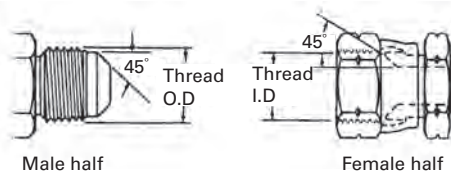

This connection is commonly used in refrigeration, automotive and truck piping systems. The connector is frequently made of brass. Both the male and female connectors have 45° seats. The seal takes place between the male flare the female cone seat.

The threads hold the connection mechanically.

Caution: In the -02, -03, -04, -05, -08 and -10 sizes, the threads of the SAE 45° flare and the SAE 37° flare are the same. However, the sealing surface angles are not the same.

Inch size	Dash size	Nominal thread size	Male thread O.D. inch		Female thread I.D. inch	
			Fract.	Dec.	Fract.	Dec.
1/8	02	5/16-24	5/16	0.31	9/32	0.27
3/16	03	3/8-24	3/8	0.38	11/32	0.34
1/4	04	7/16-20	7/16	0.44	13/32	0.39
5/16	05	1/2-20	1/2	0.50	15/32	0.45
3/8	06	5/8-18	5/8	0.63	9/16	0.57
1/2	08	3/4-16	3/4	0.75	11/16	0.69
5/8	10	7/8-14	7/8	0.88	13/16	0.81
3/4	12	1 1/16-14	1 1/16	1.06	1	0.99
7/8	14	1 1/4-12	1 1/4	1.25	1 5/32	1.16
1	16	1 3/8-12	1 3/8	1.38	1 9/32	1.29

Staplok (SAE J1467)

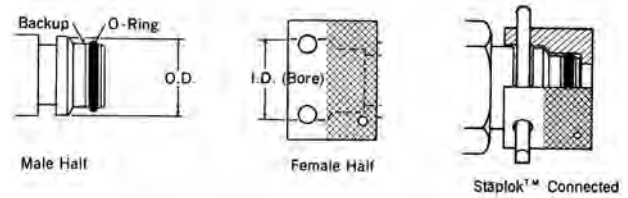

This is a radial O-Ring seal connection developed in Germany and commonly used for hydraulic application in underground mines. The male contains an exterior O-Ring and backup ring, plus a groove to accept the "staple". The female has a smooth bore

with two holes for the staple. A "U" shaped retaining clip or staple is inserted through the two holes, passing through the groove in the male to lock the connection together. The seal takes place by contact between the O-Ring in the male and the smooth bore of the female.

Inch size	Dash size	Nominal thread size	Male thread O.D. inch		Female thread I.D. inch	
			Fraction	Decimal	Fraction	Decimal
1/4	04	-	9/32	0.586	1 9/32	0.597
3/8	06	-	25/32	0.783	51/64	0.794
1/2	08	-	15/16	0.940	61/64	0.951
3/4	12	-	1 9/64	1.137	1 9/64	1.148
1	16	-	1 17/32	1.529	1 35/64	1.540
1 1/4	20	-	1 13/16	1.806	1 13/16	1.817
1 1/2	24	-	2 5/32	2.163	2 11/64	2.174
2	32	-	2 33/64	2.517	2 17/32	2.528

American connections

How to measure 4-Bolt Flange

First measure the port hole diameter using the caliper. Next, measure the longest bolt hole spacing from center-to-center (Dimension "A") or measure the flanged head diameter.

SAE J518 Code 61/62 4-Bolt Flange*

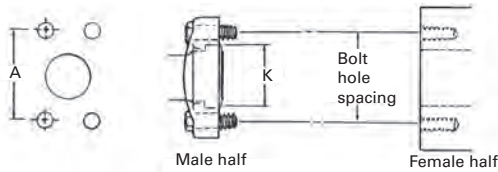

This connection is commonly used in fluid power systems. There are two pressure ratings. Code 61 is referred to as the "standard" series and Code 62 is the "6000 psi" series. The design concept for both series is the same, but the bolt hole spacing and flanged head diameters are larger for the higher pressure, Code 62 connection. The female (port) is an unthreaded hole with four bolt holes in a rectangular pattern around the port. The male consists of a flanged head, grooved

for an O-Ring, and either a captive flange or split flange halves with bolt holes to match the port. The seal takes place on the O-Ring, which is compressed between the flanged head and the flat surface surrounding the port. The threaded bolts hold the connection together.

* SAE J518, JIS B 8363, ISO/ DIS 6162 and DIN 20066 are interchangeable, except for bolt sizes.

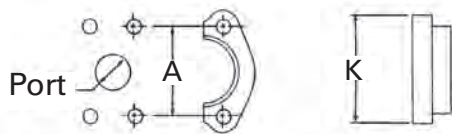

Inch Size (dash size)	Port hole I.D. inch fract. (dec.)	Bolt dimension inch		Bolt hole spacing "A" inch (dec.)		Flanged head dia. "K" inch (dec.)	
		Cd. 61	Cd. 62	Cd. 61	Cd. 62	Cd. 61	Cd. 62
1/2 (08)	1/2 (0.50)	5/16-18x1-1/4	5/16-18x1-1/4	1-1/2 (1.50)	1-19/32 (1.59)	1-3/16 (1.19)	1-1/4 (1.25)
3/4 (12)	3/4 (0.75)	3/8-16x1-1/4	3/8-16x1-1/2	1-7/8 (1.88)	2.00 (2.00)	1-1/2 (1.50)	1-5/8 (1.63)
1.00 (16)	1.00 (1.00)	3/8-16x1-1/4	7/16-14x1-3/4	2-1/16 (2.06)	2 1/4 (2.25)	1-3/4 (1.75)	1-7/8 (1.88)
1-1/4 (20)	1-1/4 (1.25)	7/16-14x1-1/2	1/2-13x1-3/4	2-5/16 (2.31)	2-5/8 (2.63)	2.00 (2.00)	2-1/8 (2.13)
1-1/2 (24)	1-1/2 (1.50)	1/2-13x1-1/2	5/8-11x2-1/4	2-3/4 (2.75)	3-1/8 (3.12)	2-3/8 (2.38)	2-1/2 (2.50)
2.00 (32)	2.00 (2.00)	1/2-13x1-1/2	3/4-10x2-3/4	3-1/16 (3.06)	3-13/16 (3.81)	2-13/16 (2.81)	3-1/8 (3.12)

ISO connections

ISO 6149 Port and Stud Ends with ISO 261 Threads and O-Ring Seal

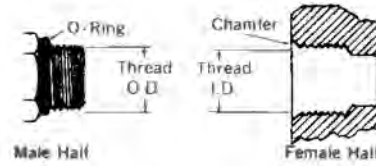

This port connection is similar to the SAE J514 Straight Thread O-Ring Boss (ORB). The major difference is that this connection uses metric threads. The male connector has a straight thread and an O-Ring. The female port has a straight thread, a machined

surface (minimum spotface) and a chamfer to accept the O-Ring. The seal takes place by compressing the O-Ring into the chamfer. The threads hold the connection mechanically.

Metric thread	Male thread O.D.	Female thread I.D.
	mm	mm
M8 x 1	8	7
M10 x 1	10	9
M12 x 1,5	12	10,5
M14 x 1,5*	14	12,5
M16 x 1,5	16	14,5
M18 x 1,5	18	16,5
M22 x 1,5	22	20,5
M27 x 2	27	25
M33 x 2	33	31
M42 x 2	42	40
M48 x 2	48	46
M60 x 2	60	58

* M14 x 1,5: Recommended for diagnostic port application.

Steel adapters

ISO connections

ISO connections

ISO/DIS 6162 4-Bolt Flange*

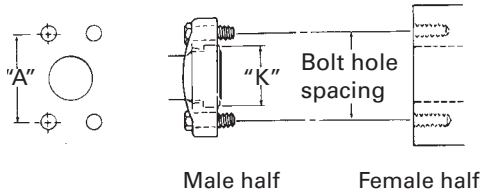

This connection is commonly used in fluid power systems. There are two pressure ratings. PN 35/350 bar (Code 61) is the "standard" series and PN 415 bar (Code 62) is the high pressure series. The design concept for both series is the same, but the bolt hole spacing and flanged head diameters are larger for the higher pressure, PN 415 bar connection. Both metric and inches bolts are used. The port will have an "M" stamped on it if metric bolts are required.

The female (port) is an unthreaded hole with four bolt holes in a rectangular pattern around the port. The male consists of a flanged head, grooved for an O-Ring, and either a captive flange or split flange halves with bolt holes to match the port. The seal takes place on the O-Ring, which is compressed between the flanged head and the flat surface surrounding the port. The threaded bolts hold the connection together.

* ISO/DIS 6162, DIN 20066, JIS B 8363 and SAE J518 are interchangeable, except for bolt sizes.

Inch size	Flanged head dia. "K"			
	ISO 6162-1 Bar (Cd.61)		ISO 6162-2 Bar (Cd.62)	
	mm	in	mm	in
1/2	30.18	1.19	31.75	1.25
3/4	38.10	1.50	41.28	1.63
1	44.45	1.75	47.63	1.88
1 1/4	50.80	2.00	53.98	2.13
1 1/2	60.33	2.38	63.50	2.50
2	71.42	2.81	79.38	3.13

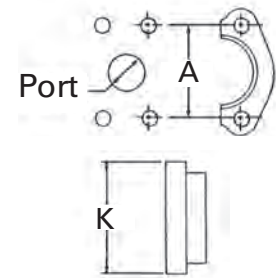

Size	Port hole	Bolt dimensions spacing		Bolt hole "A"	
		ISO 6162-1 Bar (Cd.61)	ISO 6162-2 Bar (Cd.62)	ISO 6162-1 Bar (Cd.61)	ISO 6162-2 Bar (Cd.62)
mm in (dash)	mm (in)	mm (in)	mm (in)	mm (in)	mm (in)
13(1/2) (08)	12,7 (.50)	M8 x 1.25x 30 (5/16-18 x 1 1/4)	M8 x 1.25 x 30 (5/16-18 x 1 1/4)	38.1 (1.50)	40.5 (1.57)
19(3/4) (12)	19,1 (.75)	M10 x 1.5 x 35 (3/8-16 x 1 1/4)	M10 x 1.5 x 40 (3/8-16 x 1 1/2)	47.6 (1.88)	50.8 (2.00)
25(1) (16)	25,4 (1.00)	M10 x 1.5 x 35 (3/8-16 x 1 1/4)	M12 x 1.75 x 45 (7/16-14 x 1 3/4)	52.4 (2.06)	57.2 (2.25)
32(1 1/4) (20)	31,8 (1.25)	M10 x 1.5 x 40 (7/16-14 x 1 1/2)	M14 x 2 x 50 (1/2-13 x 1 3/4)	58.7 (2.31)	66.7 (2.63)
38(1 1/2) (24)	38,1 (1.50)	M12 x 1.75 x 40 (1/2-13 x 1 1/2)	M16 x 2 x 55 (5/8-11 x 2 1/4)	69.9 (2.75)	79.4 (3.13)
51(2) (32)	50,8 (2.00)	M12 x 1.75 x 40 (1/2-13 x 1 1/2)	M20 x 2.5 x 70 (3/4-10 x 2 3/4)	77.8 (3.06)	96.8 (3.81)

BROWSE: Tools

Product Configurator +

Hose Assembly +

Cross Reference +

Crimp Specs +

eatonpowersource.com

German connections

Metric 30° (DIN 7631)

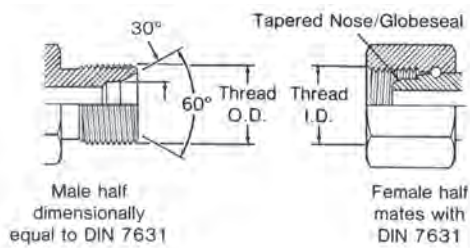

This connection is frequently used in hydraulic systems. The male has a straight metric thread and a 60° (included angle) recessed cone. The female has a straight thread and a tapered Nose/Globeseal

seat. The seal takes place by contact between the cone of the male and the nose of the tapered Nose/Globeseal flareless swivel.

The threads hold the connection mechanically.

Use with pipe/tube O.D.		Metric thread size	Male thread O.D.		Female thread I.D.	
mm	in		mm	in	mm	in
6	0.24	M12 x 1.5	12	0.47	10,5	0.41
8	0.32	M14 x 1.5	14	0.55	12,5	0.49
10	0.39	M16 x 1.5	16	0.63	14,5	0.57
12	0.47	M18 x 1.5	18	0.71	16,5	0.65
15	0.59	M22 x 1.5	22	0.87	20,5	0.81
18	0.71	M26 x 1.5	26	1.02	24,5	0.96
22	0.87	M30 x 1.5	30	1.18	28,5	1.12
28	1.10	M38 x 1.5	38	1.50	36,5	1.44
35	1.38	M45 x 1.5	45	1.77	43,5	1.71
42	1.65	M52 x 1.5	52	2.04	50,5	1.99

Metric 24° (DIN 3902)

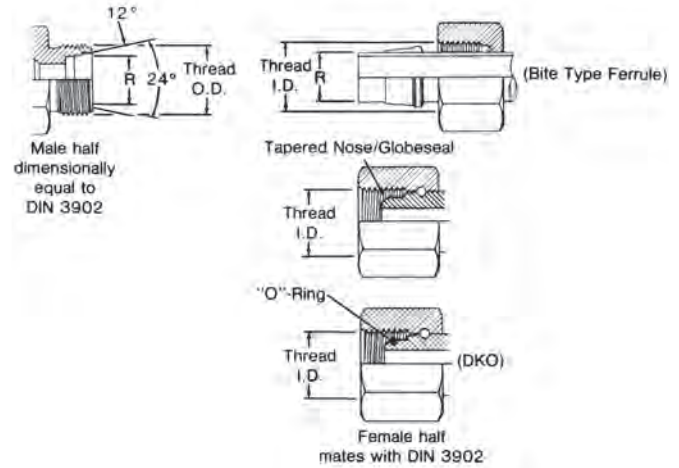

This connection style consists of a common male and three different female halves. The male has a straight metric thread, a 24° included angle and a recessed counterbore that matches the tube O.D. used with it. The female may

be a tube, nut and ferrule, a tapered nose/Globeseal flareless swivel or a tapered Nose/Globeseal flareless swivel with an O-Ring in the Nose (DKO type).

Tube O.D. "R" Dim. l.Rh.*		Tube O.D. "R" Dim. s.Rh.†		Metric thread Size	Male thread O.D.		Female thread I.D.	
mm	in.	mm	in		mm	in	mm	in
6	0.24	-	-	M12 x 1.5	12	0.47	10.5	0.41
8	0.32	6	0.24	M14 x 1.5	14	0.55	12.5	0.49
10	0.39	8	0.32	M16 x 1.5	16	0.63	14.5	0.57
12	0.47	10	0.39	M18 x 1.5	18	0.71	16.5	0.65
-	-	12	0.47	M20 x 1.5	20	0.78	18.5	0.73
15	0.59	14	0.55	M22 x 1.5	22	0.87	20.5	0.81
-	-	16	0.63	M24 x 1.5	24	0.94	22.5	0.89
18	0.71	-	-	M26 x 1.5	26	1.02	24.5	0.96
22	0.87	20	0.78	M30 x 2.0	30	1.18	28	1.11
28	1.10	25	0.98	M36 x 2.0	36	1.41	34	1.34
-	-	30	1.18	M42 x 2.0	42	1.65	40	1.57
35	1.38	-	-	M45 x 2.0	45	1.77	43	1.70
42	1.65	38	1.50	M52 x 2.0	52	2.04	50	1.97

*l.Rh. is a light duty system.

†s.Rh. is a heavy duty system.

Steel adapters

German connections

German connections

DIN 20066 4-bolt flange*

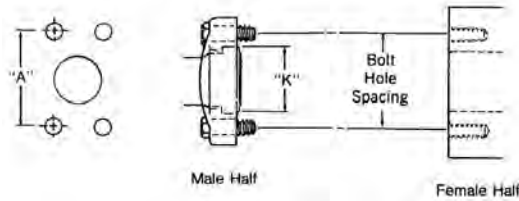

This connection is commonly used in fluid power systems. There are two pressure ratings. Form R (Code 61) is referred to as the “standard duty” series and Form S (Code 62) is the “heavy duty” series. The design concept for both series is the same, but the bolt hole spacing and flanged head diameters are larger for the higher pressure, Form S connection. Both metric and inch bolts are used. The female (port) is an unthreaded hole with four bolt holes in a rectangular pattern around the port. The male

consists of a flanged head, grooved for an O-Ring, and either a captive flange or split flange halves with bolt holes to match the port. The seal takes place on the O-Ring, which is compressed between the flanged head and the flat surface surrounding the port. The threaded bolts hold the connection together.

Note: *DIN 20066, IS/DIS 6166, JIS B 8363 and SAE J518 are interchangeable, except for bolt sizes.

Inch size	Flanged head dia. “K”			
	Form R (Cd. 61)		Form S (Cd. 62)	
	mm	in	mm	in
1/2	30.18	1.19	31.75	1.25
3/4	38.10	1.50	41.28	1.63
1	44.45	1.75	47.63	1.88
1 1/4	50.80	2.00	53.98	2.13
1 1/2	60.33	2.38	63.50	2.50
2	71.42	2.81	79.38	3.13

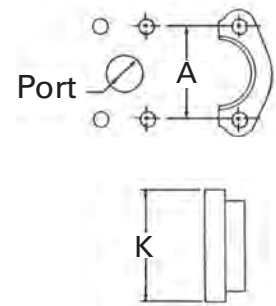

Size	Port hole	Bolt dimensions		Bolt hole spacing	
		Form R (Cd. 61)	Form S (Cd. 62)	Form R (Cd. 61)	Form S (Cd. 62)
				mm (in)	mm (in)
12 (1/2) (08)	12,7 (0.50)	M8 x 1.25 x 30 5/16–18 x 1 1/4	M8 x 1.25 x 30 5/16–18 x 1 1/4	38.10 (1.50)	40.49 (1.57)
20 (3/4) (12)	19,1 (0.75)	M10 x 1.5 x 30 3/8–16 x 1 1/4	M10 x 1.5 x 40 3/8–16 x 1 1/2	47.63 (1.88)	50.80 (2.00)
25 (1) (16)	25,4 (1.00)	M10 x 1.5 x 35 3/8–16 x 1 1/4	M12 x 1.75 x 45 7/16–14 x 1 3/4	52.37 (2.06)	57.15 (2.25)
32 (1-1/4) (20)	31,7 (1.25)	M10 x 1.75 x 40 7/16–14 x 1 1/2	M14 x 2 x 45 1/2–13 x 1 3/4	58.72 (2.31)	66.68 (2.63)
40 (1-1/2) (24)	38,0 (1.50)	M12 x 1.75 x 40 1/2–13 x 1 1/2	M16 x 2 x 55 5/8–11 x 2 1/4	69.85 (2.75)	79.38 (3.13)
50 (2) (32)	50,8 (2.00)	M12 x 1.75 x 40 1/2–13 x 1 1/2	M20 x 2.5 x 70 3/4–10 x 2 3/4	77.77 (3.06)	96.82 (3.81)

FIND IT QUICKLY

Want an easy way to find the new Eaton adapter part number?

Just go to **PowerSource Cross Reference** tool and type in the previous adapter part number here.

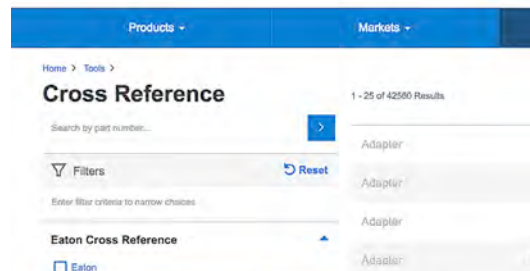

eatonpowersource.com

German connections

DIN 3852 Male connectors and female ports

Metric (DIN 3852) threads

Metric thread	Male thread O.D. "A"		Female thread I.D. "B"	
	mm	(in)	mm	(in)
M12 x 1.5	12	0.47	10,5	0.41
M14 x 1.5	14	0.55	12,5	0.49
M16 x 1.5	16	0.63	14,5	0.57
M18 x 1.5	18	0.71	16,5	0.65
M20 x 1.5	20	0.78	18,5	0.73
M22 x 1.5	22	0.87	20,5	0.81
M24 x 1.5	24	0.94	22,5	0.89
M26 x 1.5	26	1.02	24,5	0.96
M27 x 2	27	1.06	25	0.98
M30 x 1.5	30	1.18	28,5	1.12
M30 x 2	30	1.18	28	1.10
M33 x 2	33	1.30	31	1.22
M36 x 1.5	36	1.41	34,5	1.36
M36 x 2	36	1.41	34	1.33
M38 x 1.5	38	1.49	36,5	1.43
M38 x 2	38	1.49	36	1.41
M42 x 1.5	42	1.65	40,5	1.60
M42 x 2	42	1.65	40	1.57
M45 x 1.5	45	1.77	43,5	1.71
M45 x 2	45	1.77	43	1.69
M48 x 1.5	48	1.89	46,5	1.83
M48 x 2	48	1.89	46	1.81
M52 x 1.5	52	2.04	50,5	1.89
M52 x 2	52	2.04	50	1.97

For DIN 3852 Whitworth pipe thread dimensions, see BSPT/BSPP dimensions. They are the same.

How the seal works

This DIN is controlled by Germany, but other countries may use it as a reference for their connector and port designs. The chart below illustrates the various forms and how they seal.

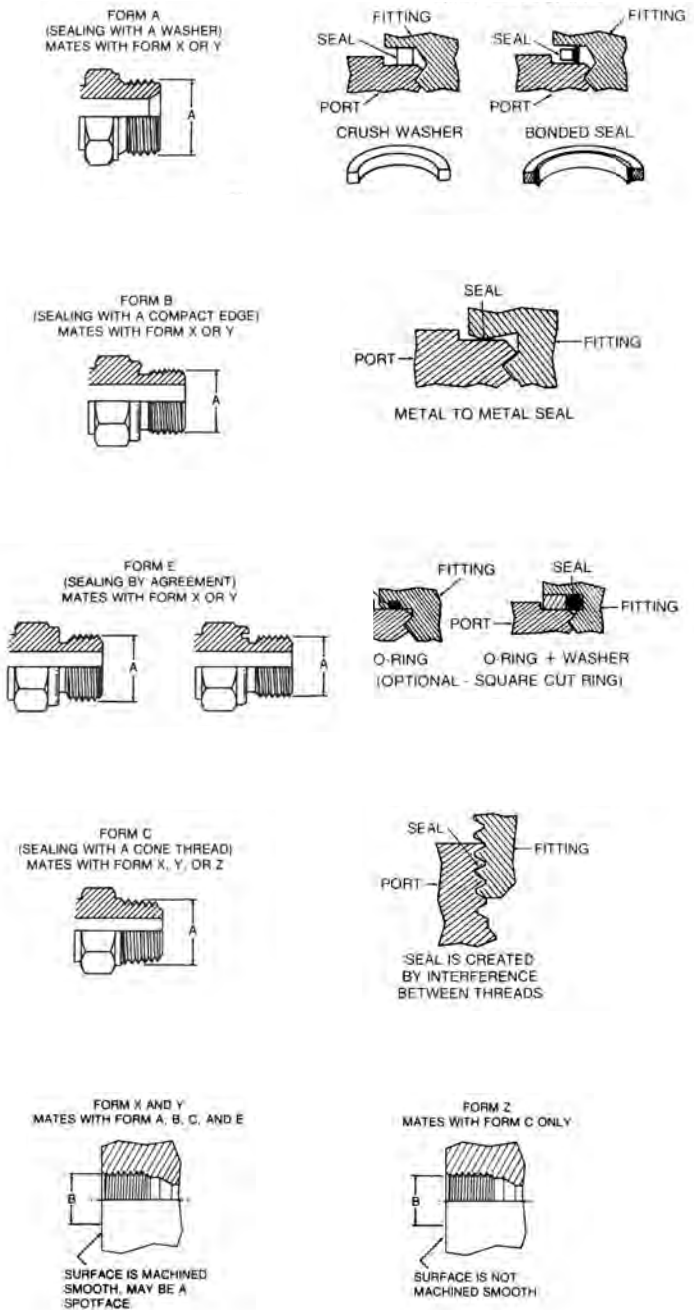

Steel adapters

French connections and British connections

J

French connections

Millimetric and GAZ series

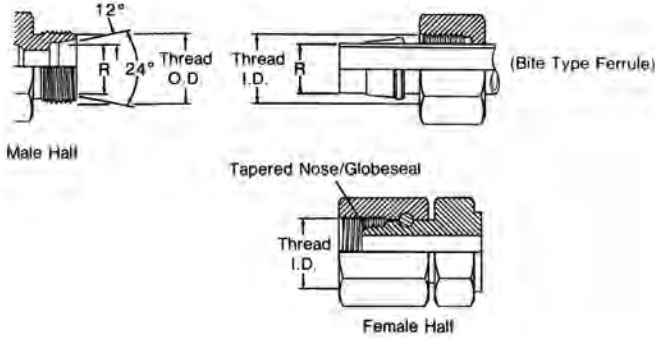

This connection consists of a common male and two different females. The millimetric series is used with

whole number metric O.D. tubing and the GAZ Series is used with fractional number metric O.D. pipe size tubing.

British connections

British standard pipe (BSP/BSPP/BSPT)

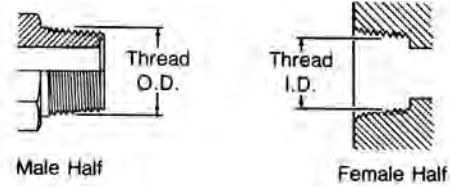

This BSPT (tapered) connection is similar to the NPT, except that the thread pitches are different in most sizes, and the thread

form and O.D.s are close but not the same. Sealing is accomplished by thread distortion. A thread sealant is recommended.

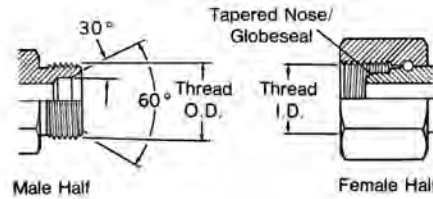

The BSP (parallel) male is similar to the NPSM male except the thread pitches are different in most sizes.

The female swivel BSPP has a tapered nose/Globeseal flareless swivel which seals on the cone seat of the male.

Millimetric and GAZ threads

Tubing O.D. "R" dim.		"Gaz" pipe O.D. "R" dim.		Metric thread	Male Thread O.D. "A"		Female Thread I.D. "B"	
mm	in	mm	in		mm	in	mm	in
6	0.24	-	-	M12 x 1.5	12	0.47	11	0.43
8	0.32	-	-	M14 x 1.5	14	0.55	12.5	0.49
10	0.39	-	-	M16 x 1.5	16	0.63	14.5	0.57
12	0.47	-	-	M18 x 1.5	18	0.71	16.5	0.65
14	0.55	13.25	0.52	M20 x 1.5	20	0.78	18.5	0.73
15	0.59	-	-	M22 x 1.5	22	0.87	20.5	0.81
16	0.63	16.75	0.66	M24 x 1.5	24	0.94	22.5	0.89
18	0.71	-	-	M27 x 1.5	27	1.06	25.5	1.00
22	0.87	21.25	0.83	M30 x 1.5	30	1.18	28.5	1.12
25	0.98	-	-	M33 x 1.5	33	1.30	31.5	1.24
28	1.10	26.75	1.05	M36 x 1.5	36	1.41	34.5	1.36
30	1.18	-	-	M39 x 1.5	39	1.54	37.5	1.48
32	1.25	-	-	M42 x 1.5	42	1.65	40.5	1.60
35	1.38	33.50	1.32	M45 x 1.5	45	1.77	43.5	1.71
38	1.50	-	-	M48 x 1.5	48	1.89	46.5	1.83
40	1.57	42.25	1.66	M52 x 1.5	52	2.04	50.5	1.99
45	1.77	-	-	M54 x 2.0	54	2.12	52	2.05
-	-	48.25	1.90	M58 x 2.0	58	2.28	55	2.16

BSPT/BSPP threads

Inch size	Dash size	Nominal thread size	Male thread O.D.		Female thread I.D.	
			fraction	decimal	fraction	decimal
1/8	02	1/8-28	3/8	0.38	11/32	0.35
1/4	04	1/4-19	33/64	0.52	15/32	0.47
3/8	06	3/8-19	21/32	0.65	19/32	0.60
1/2	08	1/2-14	13/16	0.82	3/4	0.75
5/8	10	5/8-14	7/8	0.88	13/16	0.80
3/4	12	3/4-14	1 1/32	1.04	31/32	0.97
1	16	1-11	1 5/16	1.30	1 7/32	1.22
1 1/4	20	1 1/4-11	1 21/32	1.65	1 9/16	1.56
1 1/2	24	1 1/2-11	1 7/8	1.88	1 25/32	1.79
2	32	2-11	2 11/32	2.35	2 1/4	2.26

*Frequently, the thread size is expressed as a fractional dimension preceded by the letter "G" or the letter "R". The "G" represents a parallel thread and the "R" indicates a tapered thread. For example, BSPP 3/8-19 may be expressed as G 3/8, and BSPT 3/8-19 may be expressed as R3/8.

Japanese connections

JIS 30° male inverted seat, parallel pipe threads

(Threads per JIS B 0202)

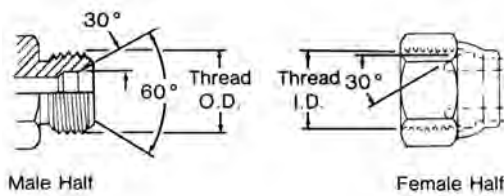

The JIS parallel is similar to the BSPP connection. The JIS parallel thread and

the BSPP connection are interchangeable.

Inch size	Dash size	Nominal thread size (similar to BSPP)	Male thread O.D.		Female thread O.D.	
			fract.	mm	fract.	mm
1/4	6 (04)	1/4-19	33/64	13.2	15/32	11.9
3/8	9 (06)	3/8-19	21/32	16.7	19/32	15.3
1/2	12 (08)	1/2-14	13/16	21.0	3/4	19.2
3/4	19 (12)	3/4-14	1 1/32	26.4	31/32	24.6
1	25 (16)	1-11	1 5/16	33.3	1 7/32	30.9
1 1/4	32 (20)	1 1/4-11	1 21/32	41.9	1 9/16	39.6
1 1/2	38 (24)	1 1/2-11	1 7/8	47.8	1 25/32	45.5
2	50 (32)	2-11	2 11/32	59.7	2 1/4	57.4

JIS 30° male inverted seat, parallel pipe threads

(Threads per JIS B 0207)

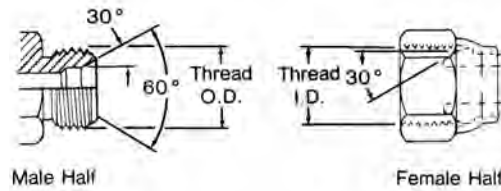

The JIS parallel (metric) is the same as the JIS parallel

(PF), except for the thread difference.

Inch size	Dash size equivalent	Thread size	Male thread O.D.		Female thread O.D.	
			mm	dec.	mm	dec.
6	04	M14 x 1.5	14	0.55	12.5	0.49
9	06	M18 x 1.5	18	0.71	16.5	0.65
12	08	M22 x 1.5	22	0.87	20.5	0.81
19	12	M30 x 1.5	30	1.18	28.5	1.12
25	16	M33 x 1.5	33	1.30	31.5	1.24
32	20	M42 x 1.5	42	1.65	40.5	1.60

JIS Tapered pipe (PT)

(Threads per JIS B 0203)

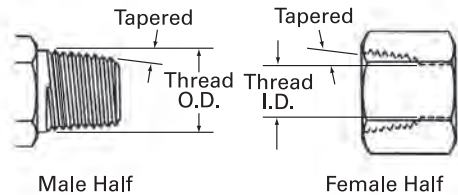

The JIS tapered thread is similar to the BSPT connection in design, appearance and dimensions.

The JIS tapered thread and the BSPT connection are interchangeable.

Inch size	Dash size	Nominal thread size (similar to BSPP)	Male thread O.D.		Female thread I.D.	
			fract.	mm.	fract.	mm
1/4	6 (04)	1/4-19	33/64	13.2	15/32	11.9
3/8	9 (06)	3/8-19	21/32	16.7	19/32	15.3
1/2	12 (08)	1/2-14	13/16	21.0	3/4	19.2
3/4	19 (12)	3/4-14	1 1/32	26.4	31/32	24.6
1	25 (16)	1-11	1 5/16	33.3	1 7/32	30.9
1 1/4	32 (20)	1 1/4-11	1 21/32	41.9	1 9/16	39.6
1 1/2	38 (24)	1 1/2-11	1 7/8	47.8	1 25/32	45.5
2	50 (32)	2-11	2 11/32	59.7	2 1/4	57.4

JIS 30° female (cone) seat, parallel pipe threads (PT)

(Threads per JIS B 0202)

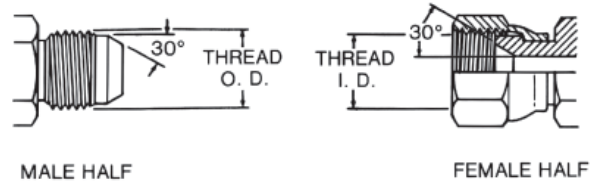

The Japanese JIS 30° flare is similar to the American SAE 37° flare connection in application as well as sealing

principles. However, the flare angle and dimensions are different. The threads are similar to BSPP.

Inch size	Dash size	Nominal thread size (similar to BSPP)	Male thread O.D.		Female thread O.D.	
			fract.	mm	fract.	mm
1/4	6 (04)	1/4-19	33/64	13.2	15/32	11.9
3/8	9 (06)	3/8-19	21/32	16.7	19/32	15.3
1/2	12 (08)	1/2-14	13/16	21.0	3/4	19.2
3/4	19 (12)	3/4-14	1 1/32	26.4	31/32	24.6
1	25 (16)	1-11	1 5/16	33.3	1 7/32	30.9
1 1/4	32 (20)	1 1/4-11	1 21/32	41.9	1 9/16	39.6
1 1/2	38 (24)	1 1/2-11	1 7/8	47.8	1 25/32	45.5
2	50 (32)	2-11	2 11/32	59.7	2 1/4	57.4

Steel adapters

Japanese connections

Japanese connections

JIS B 8363 4-bolt flange*

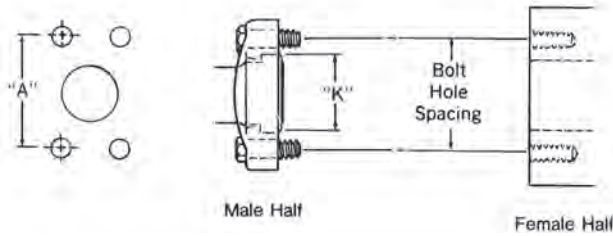

This connection is commonly used in fluid power systems. There are two pressure ratings. Type I (Code 61) is referred to as the “standard” series and Type II (Code 62) is the “6000 psi” series. The design concept for both series is the same, but the bolt hole spacing and flanged head diameters are larger for the higher pressure, Type II connection. Both metric and inch bolts are used. The female (port) is an unthreaded hole with four bolt holes in a rectangular pattern around the port. The male consists of a

flanged head, grooved for an O-Ring, and either a captive flange or split flange halves with bolt holes to match the port. The seal takes place on the O-Ring, which is compressed between the flanged head and the flat surface surrounding the port. The threaded bolts hold the connection together.

Note: *JIS B 8363, ISO/DIS 6162, DIN 20066, and SAE J518 are interchangeable, except for bolt sizes.

Size	Flanged head dia. “K”				
	Type I bar (Cd. 61)		Type II bar (Cd. 62)		
in	mm	in	mm	in	mm
1/2	30,18	1.19	31,75	1.25	
3/4	38,10	1.50	41,28	1.63	
1	44,45	1.75	47,63	1.88	
1 1/4	50,80	2.00	53,98	2.13	
1 1/2	60,33	2.38	63,50	2.50	
2	71,42	2.81	79,38	3.13	

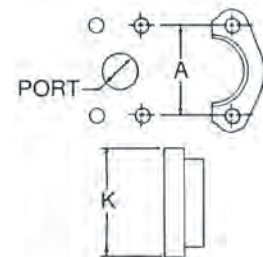

Size	Port hole	Bolt dimensions		Bolt hole spacing “A”	
		Type I (Cd. 61)	Type II (Cd. 62)	Type I (Cd. 61)	Type II (Cd. 62)
mm (in) (dash)	mm (in)	mm (in)	mm (in)	mm (in)	mm (in)
12 (1/2) (08)	12,7 (0.50)	M8 x 1.25 x 30 (5/16–18 x 1 1/4)	M8 x 1.25 x 30 (5/16–18 x 1 1/4)	38,1 (1.50)	40,49 (1.57)
19 (3/4) (12)	19,1 (0.75)	M10 x 1.5 x 30 (3/8–16 x 1 1/4)	M10 x 1.5 x 40 (3/8–16 x 1 1/2)	47,63 (1.88)	50,80 (2.00)
25 (1) (16)	25,4 (1.00)	M10 x 1.5 x 30 (3/8–16 x 1 1/4)	M12 x 1.75 x 45 (7/16–14 x 1 3/4)	52,37 (2.06)	57,15 (2.25)
32 (1 1/4) (20)	31,7 (1.25)	M10 x 1.5 x 40 (7/16–14 x 1 1/2)	M14 x 2 x 45 (1/2–13 x 1 3/4)	58,72 (2.31)	66,68 (2.63)
38 (1 1/2) (24)	38,0 (1.50)	M12 x 1.75 x 40 (1/2–13 x 1 1/2)	M16 x 2 x 55 (5/8–11 x 2 1/4)	69,85 (2.75)	79,38 (3.13)
50 (2) (32)	50,8 (2.00)	M12 x 1.75 x 40 (1/2–13 x 1 1/2)	M20 x 2.5 x 70 (3/4–10 x 2 3/4)	77,77 (3.06)	96,82 (3.81)

Tools

Cross Reference

Search by part number, part type and competitor

Search by part number... ➤

Filters Reset

Enter filter criteria to narrow choices

Eaton Cross Reference

Eaton

Recommendations may not be direct replacements. Please assess if the recommendation fulfills your needs.

Competitor Cross Reference

Piper Industries

Powertrack

Shaver

Sloan Transportation

Smc Pneumatics

Ssp

Stratoflex

Swagelok

Synflex

Tompkins

Trident

Velvac

eatonpowersource.com

Japanese connections

JIS 210 Kgf/cm² 4-bolt square flange

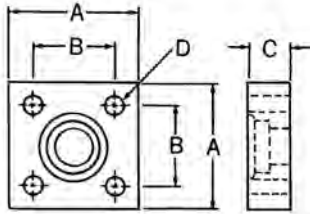

The JIS 4-bolt square flange connection is similar in concept to the SAE 4-bolt flange connection, except that

the JIS bolt pattern is square and the flange itself is different.

Size mm	Appx. inch size	Bolt size mm (bolt length for long design)	Dim. "A" mm (inch)	Dim. "B" mm (inch)	Dim. "C" mm (inch)	Bolt hole dia "D" mm (inch)
12	1/2	M10 x 1.5 x 55 (80)	63 (2.48)	40 (1.57)	22 (0.87)	11 (0.43)
19	3/4	M10 x 1.5 x 55 (80)	68 (2.67)	45 (1.77)	22 (0.87)	11 (0.43)
25	1	M12 x 1.75 x 70 (100)	80 (3.15)	53 (2.09)	28 (1.10)	13 (0.51)
32	1 1/4	M12 x 1.75 x 70 (100)	90 (3.54)	63 (2.48)	28 (1.10)	13 (0.51)
38	1 1/2	M16 x 2.0 x 90 (130)	100 (3.94)	70 (2.76)	36 (1.42)	18 (0.71)
50	2	M16 x 2.0 x 90 (130)	112 (4.41)	80 (3.15)	36 (1.42)	18 (0.71)

Komatsu 30° flare

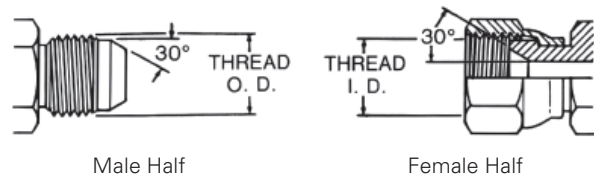

The Japanese Komatsu 30° flare is similar to the American SAE 37° flare connection in application as well as sealing

principles. However, the flare angle and dimensions are different. The threads are metric.

Komatsu Nominal size mm	Eaton equivalent	Komatsu Thread
02	04	M14 x 1.5
03	06	M18 x 1.5
04	08	M22 x 1.5
05	10	M24 x 1.5
06	12	M30 x 1.5
10	16	M33 x 1.5
12	20	M36 x 1.5
14	24	M42 x 1.5

JIS 210 Kgf/cm² O-ring

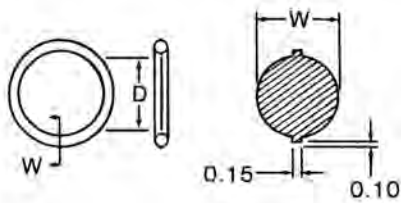

Nominal size mm	Dim. "D" mm	Dim. "W" mm
12	24.4 ± 0.15	3.1 ± 0.1
19	29.4 ± 0.15	3.1 ± 0.1
25	34.4 ± 0.15	3.1 ± 0.1
32	39.4 ± 0.15	3.1 ± 0.1
38	49.4 ± 0.15	3.1 ± 0.1
50	59.4 ± 0.15	3.1 ± 0.1

Steel adapters

Thread engagement nominal dimensions

J

Thread engagement

Dimensions may vary due to tolerance conditions.

Listed below are the thread engagement dimensions (B) which must be taken into consideration when making connection with ports or appropriate female adapters. The "B" dimension must be subtracted from the overall length (A) to insure proper connection.

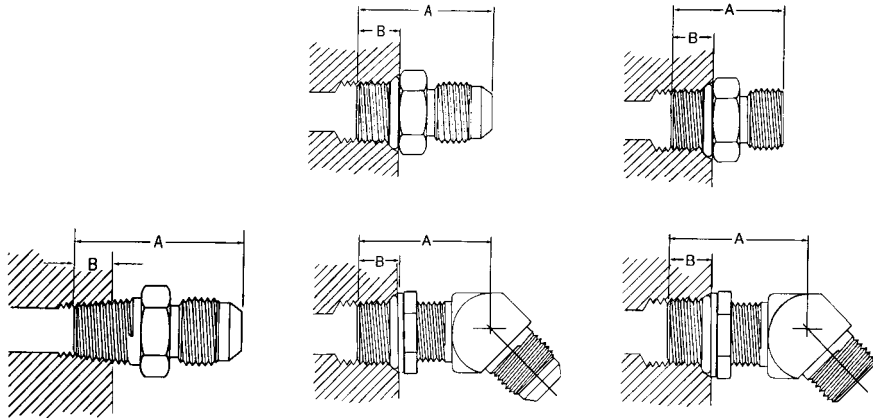

Dash size	Male pipe		SAE O-ring boss SAE J1926 with SAE 37° flare J514		SAE O-ring boss SAE J1926 with ORS J1453	
	Straight and angled dimension "B"		Straight and adjustable dimension "B"		Straight and adjustable dimension "B"	
	mm	in	mm	in	mm	in
-02	6,4	0.25	–	–	–	–
-04	9,7	0.38	9,1	0.36	10,9	0.43
-05	–	–	9,1	0.36	10,9	0.43
-06	9,7	0.38	9,1	0.39	11,9	0.47
-08	12,7	0.50	10,9	0.43	14,0	0.55
-10	–	–	12,7	0.50	16,0	0.63
-12	15,7	0.62	15,0	0.59	18,5	0.73
-14	–	–	15,0	0.59	–	–
-16	17,5	0.69	15,0	0.59	18,5	0.73
-20	17,5	0.69	15,0	0.59	18,5	0.73
-24	17,5	0.69	15,0	0.59	18,5	0.73
-32	19,1	0.75	15,0	0.59	–	–

Allowable bulkhead thickness

For ORS

Dash size	Hole diameter	ORS bulkhead thickness			
		Min		Max	
		mm	in	mm	in
-04	0.575 +.015/-.000	5,1	0.20	12,7	0.50
-06	0.700 +.015/-.000	5,1	0.20	15,0	0.59
-08	0.825 +.015/-.000	5,6	0.22	15,0	0.59
-10	1.015 +.015/-.000	5,8	0.23	15,0	0.59
-12	1.200 +.015/-.000	6,4	0.25	15,0	0.59
-16	1.450 +.015/-.000	6,4	0.25	15,2	0.60
-20	1.715 +.015/-.000	6,4	0.25	15,2	0.60
-24	2.030 +.015/-.000	6,4	0.25	15,2	0.60

For SAE 37° flare

Dash size	Hole diameter	SAE 37° bulkhead thickness straights				SAE 37° bulkhead thickness shapes			
		Min		Max		Min		Max	
		mm	in	mm	in	mm	in	mm	in
-03	0.391 +.016/-.000	1,3	0.05	10,4	0.41	3,3	0.13	6,4	0.25
-04	0.453 +.016/-.000	1,3	0.05	10,4	0.41	3,3	0.13	7,1	0.28
-05	0.516 +.016/-.000	1,3	0.05	10,4	0.41	3,3	0.13	7,1	0.28
-06	0.578 +.016/-.000	1,3	0.05	11,2	0.44	3,3	0.13	7,6	0.30
-08	0.766 +.016/-.000	1,3	0.05	11,2	0.44	4,1	0.16	8,6	0.34
-10	0.891 +.016/-.000	1,3	0.05	11,9	0.47	4,1	0.16	9,1	0.36
-12	1.076 +.016/-.000	1,3	0.05	11,9	0.47	4,1	0.16	9,7	0.38
-16	1.328 +.016/-.000	1,3	0.05	11,9	0.47	4,1	0.16	9,7	0.38
-20	1.656 +.031/-.000	1,3	0.05	11,9	0.47	4,1	0.16	9,7	0.38
-24	1.906 +.031/-.000	1,3	0.05	11,9	0.47	4,1	0.16	9,7	0.38

Metric thread dimensions

Conversion adapters

Sealing is achieved by means of an O-Ring, retaining washer and a properly machined port. The O-Ring is "captured" by the I.D. of the retaining washer. The port may be of the spot faced or a flat machined surface as long as the D6 dimension is met. Assembly instructions for adjustable type adapters are presented on page 26.

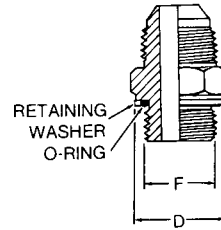
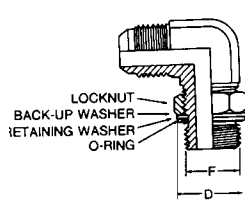

DIN 3852 large spot face

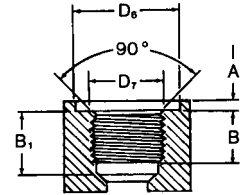

Equivalent to DIN 3852 form x

Thread size	M 10 x 1	M 12 x 1.5	M 14 x 1.5	M 16 x 1.5	M 18 x 1.5	M 20 x 1.5	M 22 x 1.5	M 26 x 1.5	M 27 x 2	M 33 x 2	M 42 x 2	M 48 x 2
F Thread Dia.	10.0	12.0	14.0	16.0	18.0	20.0	22.0	26.0	27.0	33.0	42.0	48.0
A max	1.0	1.5	1.5	1.5	2.0	2.0	2.5	2.5	2.5	2.5	2.5	2.5
B min (full thread)	12.0	12.0	12.0	12.0	12.0	14.0	14.0	16.0	16.0	18.0	20.0	22.0
B1 min	13.5	18.5	18.5	18.5	18.5	20.5	20.5	22.5	24.0	26.0	28.0	30.0
D max	15.7	18.7	19.7	23.2	26.2	28.2	30.2	35.2	36.2	43.2	52.7	58.7
D6 min	16.2	19.2	20.2	23.7	26.9	28.9	30.7	35.7	36.7	44.4	53.4	59.9
D7 max	10.2	12.2	14.2	16.2	18.2	20.2	22.2	26.2	27.2	33.3	42.3	48.3

BSPP (parallel) threads

Sealing is achieved by means of an O-Ring, retaining washer and a properly machined port.

The O-Ring is "captured" by the I.D. of the retaining washer. The compression is controlled by the thickness of the retaining washer.

The port may be of the spot faced or a flat machined surface as long as the D6 dimension is met.

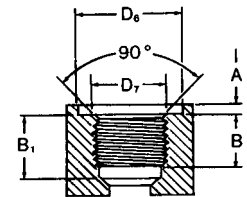
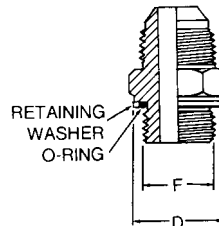
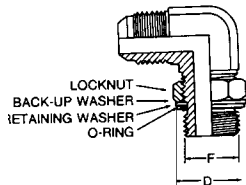

Thread size	G 1/8"-28		G 1/4"-19		G 3/8"-19		G 1/2"-14		G 3/4"-14		G 1"-11		G 1 1/4"-11		G 1 1/2"-11	
	mm	in	mm	in	mm	in	mm	in	mm	in	mm	in	mm	in	mm	in
F Thread Dia.	9,7	0.38	13,2	0.50	16,7	0.66	20,9	0.83	26,4	1.04	33,3	1.31	41,9	1.65	47,8	1.88
A max	1,0	0.04	2,0	0.08	2,05	0.10	2,5	0.10	2,5	0.10	2,5	0.10	2,5	0.10	2,5	0.10
B1 min (full thread)	8,0	0.31	12,0	0.47	12,0	0.47	14,0	0.63	16,0	0.63	18,0	0.71	20,0	0.79	22,0	0.87
B1 min	13,0	0.51	18,5	0.73	18,5	0.73	22,0	0.94	24,0	0.94	27,0	1.06	29,0	1.14	31,0	1.22
D max	15,7	0.62	19,7	0.78	24,0	0.94	28,7	1.38	35,2	1.38	43,2	1.70	52,7	2.07	58,7	2.31
D6 min	16,2	0.64	20,2	0.81	24,9	0.98	29,4	1.43	36,4	1.43	44,4	1.75	53,4	2.10	59,9	2.36
D7 max	10,0	0.39	13,4	0.53	16,9	0.67	21,2	1.05	26,7	1.05	33,6	1.32	42,3	1.67	48,2	1.90

BSPT (tapered) threads port sealing

Sealing is achieved by means of metal to metal deformation of the adapter and port threads.

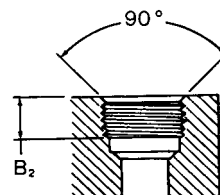

Thread size 11	R 1/8"-28		R 1/4"-19		R 3/8"-19		R 1/2"-14		R 3/4"-14		R 1"-11		R 1 1/4"-11		R 1 1/2"-11	
	mm	in	mm	in	mm	in	mm	in	mm	in	mm	in	mm	in	mm	in
B2 min (full thread)	5,5	0.22	8,5	0.33	8,5	0.33	10,5	0.41	13,0	0.51	14,5	0.57	17,0	0.67	17,0	0.67

Steel adapters

Hose fitting pressure charts

J

Pressure performance - Thread style

Eaton closely follows industry standards in design and in application recommendations. A key principle within ISO, SAE and other standards bodies is that the **maximum dynamic working pressure of the hose or adapter assembly** is the lesser of the hose and end connector(s) used.

The first table below provides excerpts from standard industry pressure rating charts for connector types as published by SAE (Society of Automotive Engineers).

Note: The tables below are applicable for low carbon free machining steels typically used in Fluid Power connections. For port type connections, the material and design of the port must be considered and may reduce expected strength.

For high pressure applications Eaton recommends the use of more robust connector designs such as Code 62 flange or O-Ring face seal.

Selected SAE pressure ratings

Dash size	Inch size	SAE 37°	Pipe SAE J476	Male ORB SAE J1926 ORS adapt.	Male ORB SAE J1926 non-ORS adapt.	Adjustable SAE J1926 ORS	Adjustable ORB non-ORS	ORS	Inverted flare	Code 61 Flange	Code 62 Flange
-2	1/8	5000	5000	-	5000	-	5000	-	5000	-	-
-3	3/16	5000	-	9000	5000	6000	5000	-	5000	-	-
-4	1/4	4500	5000	9000	5000	6000	4500	9000	4500	-	-
-5	5/16	4000	-	9000	5000	6000	4500	9000	4000	-	-
-6	3/8	4000	4000	9000	5000	6000	4000	9000	4000	-	-
-8	1/2	4000	3000	9000	4500	6000	4000	9000	4000	5000	6000
-10	5/8	3000	-	9000	3500	6000	3000	6000	3000	-	-
-12	3/4	3000	2500	6000	3500	6000	3000	6000	3000	5000	6000
-14	7/8	2500	-	6000	3000	6000	2500	6000	2500	-	-
-16	1	2500	2000	6000	3000	5000	2500	6000	2500	5000	6000
-20	1 1/4	2000	1150	4000	2500	4000	2000	3600	2000	4000	6000
-24	1 1/2	1500	1000	4000	2500	3000	2000	3600	1500	3000	6000
-32	2	1125	1000	3000	2000	2500	1500	3000	1125	3000	6000

International pressure rating charts

Maximum working pressure (PSI)

Hose fitting connection	Hose fitting size									
	-04	-05	-06	-08	-10	-12	-16	-20	-24	-32
Male British Pipe (BSP)	5000	-	4000	4000	3500	4000	3500	2500	2,000	2000
Female British Pipe (BSP)	5000	-	4000	4000	3500	4000	3500	2500	2,000	2000
Female Pipe (JIS)	5000	-	5000	5000	-	4000	4000	-	-	-

Maximum working pressure (PSI)

Hose fitting Connection	Hose fitting size									
	-06	-08	-10	-12	-15	-18	-22	-28	-35	-42
DIN light	3625	3625	3625	3625	3625	2325	2325	1450	1450	1450

Pressure performance - All Eaton Components

With higher pressures it is critical to know the construction materials and manufacturing method to ensure performance. When all components in a system are

Eaton supplied, for example an Eaton hose fitting is mated with an Eaton adapter or tube fitting, the combination may be used at higher pressures with confidence.

These higher ratings are noted in the chart below.

Maximum dynamic working pressure of the hose or adapter assembly is the lesser of the hose and end connector(s) used.

All Eaton pressure ratings¹

Dash Size	Inch Size	SAE 37° JIC	Male Pipe	Female Pipe ²	Male ORB ORS Adapters	Male ORB Non-ORS Adapters	Adjustable ORB ORS Adapters	Adjustable ORB Non-ORS Adapters	ORS	Male Flareless Ermeto	Code 61	Code 62	STC
-2	1/8	-	10000	6000	-	5000	-	5000	-	5000	-	-	-
-3	3/16	-	-	-	9000	5000	6000	5000	-	5000	-	-	-
-4	1/4	7000	9500	5000	9000	5000	6000	4500	9000	4500	-	-	6000
-5	5/16	7000	-	-	9000	5000	6000	4500	-	4000	-	-	-
-6	3/8	5000	8000	4000	9000	5000	6000	4000	9000	4000	-	-	5000
-8	1/2	4000	6000	4000	9000	4500	6000	4000	9000	4000	5000	6000	4250
-10	5/8	3800	-	-	9000	3500	6000	3000	9000	3000	-	-	4000
-12	3/4	5000	5000	3500	6000	3500	6000	3000	6000	3000	5000	6000	4000
-14	7/8	-	-	-	6000	3000	6000	2500	-	2500	-	-	-
-16	1	5000	4000	3000	6000	3000	5000	2500	6000	2500	5000	6000	4000
-20	1 1/4	5000	3000	2000	4000	2500	4000	2000	4500	2000	4000	6000	-
-24	1 1/2	2100	2000	1500	4000	2500	3000	2000	4000	1500	3000	6000	-
-32	2	1750	2000	1500	3000	2000	2500	1500	3000	1125	3000	6000	-

1) These ratings are based on both brazed and one piece construction, one-piece pressures could be increased. Please contact Eaton in these situations.

2) This rating is for thin walled adapters or fittings, the use of manifolds or oversized female ports would allow full rated male pressures.

Dynamic operating pressure

Dynamic operating conditions refers to cyclic pressure impulses, usually considered to be from near zero to the highest system pressure. Hydraulic standards typically represent these as square waves and expect a component to handle on the order of 200,000 to well over one million such cycles with a burst: operating safety factor of 4:1. The above charts are created with dynamic applications in mind. Most industrial and mobile hydraulic systems fit the dynamic operating pressure profile, for example hydraulic work circuits on construction equipment or on injection molding equipment.

Static operating pressure

Static operating conditions typically range from zero to operating pressure, but with far fewer cycles expected for the system life – perhaps 30,000 to 50,000 cycles and sharp pressure spikes are not expected, allowing a burst: operating safety factor of 3:1 or less. For static operating conditions, the Eaton ratings above can be safely increased by 25-30%. For example, a 3000 psi dynamic rated hose might be used in a 4000 psi static pressure application. Typical examples of static applications are water blast and hydraulic jacking.

Materials

The above tables represent performance using common low carbon steel material. Other materials and their

characteristics influence these ratings. Medium carbon steels or heat treated materials can support higher working pressures. Conversely non-ferrous materials such as aluminum or brass will have reduced capability – as much as 50%, or less, pressure handling capability. It is important to consider material properties in designing a system to ensure pressure rating compatibility of all materials.

Design & application

Eaton's Fluid Conveyance engineering and support teams have many decades of experience in designing, manufacturing and servicing hydraulic and other fluid conveyance systems globally. Eaton's product line is designed as a comprehensive collection of hose, fittings,

connectors, couplings and accessories that allow a system designer to select components to complete a fluid power system or a service technician to replace a component with confidence. The individual product specifications, the above pressure ratings and other technical information are intended as supporting guidelines for system design and service needs and are not to be construed as a guarantee of performance of the system or of individual Eaton components. Eaton provides comprehensive technical support so please call with questions about pressure needs not covered by these charts or for specific application support.

Steel adapters

Maximum operating pressure

J Hydraulic tubing—Maximum operating pressures

SAEJ356, J524, J525, J526, J527

Tube O.D.	Dash size	Tubing wall thickness (in inches)											
		0.028		0.035		0.049		0.065		0.083		0.095	
-	-	bar	psi	bar	psi	bar	psi	bar	psi	bar	psi	bar	psi
0.19	-03	297,0	4250	375,0	5450	-	-	-	-	-	-	-	-
0.25	-04	213,0	3100	272,0	3950	396,0	5750	420,0	6000	-	-	-	-
0.31	-05	169,0	2450	213,0	3100	315,0	4500	420,0	6000	-	-	-	-
0.38	-06	140,0	2000	175,0	2550	251,0	3650	350,0	5000	420,0	6000	420,0	6000
0.50	-08	-	-	127,0	1850	186,0	2700	251,0	3650	335,0	4800	388,0	5550
0.62	-10	-	-	105,0	1500	145,0	2100	196,0	2850	258,0	3750	299,0	4350
0.75	-12	-	-	84,0	1200	122,0	1750	162,0	2350	210,0	3050	248,0	3550
1.00	-16	-	-	62,0	900	89,0	1300	122,0	1750	157,0	2250	182,0	2600
1.25	-20	-	-	-	-	70,0	1000	93,0	1350	122,0	1750	143,0	2050
1.50	-24	-	-	-	-	-	-	79,0	1150	100,0	1450	119,0	1700
2.00	-32	-	-	-	-	-	-	58,0	850	77,0	1100	87,0	1250

Tube O.D.	Dash size	Tubing wall thickness (in inches)											
		0.109		0.120		0.134		0.148		0.156		0.188	
-	-	bar	psi	bar	psi	bar	psi	bar	psi	bar	psi	bar	psi
0.19	-03	-	-	-	-	-	-	-	-	-	-	-	-
0.25	-04	-	-	-	-	-	-	-	-	-	-	-	-
0.31	-05	-	-	-	-	-	-	-	-	-	-	-	-
0.38	-06	-	-	-	-	-	-	-	-	-	-	-	-
0.50	-08	420,0	6000	420,0	6000	-	-	-	-	-	-	-	-
0.62	-10	353,0	5050	392,0	5600	-	-	-	-	-	-	-	-
0.75	-12	286,0	4150	322,0	4600	-	-	-	-	-	-	-	-
1.00	-16	210,0	3000	231,0	3350	262,0	3800	294,0	4200	-	-	-	-
1.25	-20	162,0	2350	182,0	2650	189,0	2700	203,0	2950	217,0	3100	259,0	3750
1.50	-24	134,0	1950	148,0	2150	171,0	2450	171,0	2450	182,0	2600	220,0	3150
2.00	-32	100,0	1450	112,0	1600	126,0	1800	140,0	2000	147,0	2100	178,0	2550

Maximum operating pressure ratings at specified wall thickness are based upon recommended tubing ratings per SAEJ1065 as well as

limited laboratory test data. Operating pressures are based upon a 4:1 safety factor relative to tube burst data. Eaton recommends a

maximum operating pressure of the joint which is the lesser of the tubing rating or the mating connector rating.

Recommended wall thickness for tube fitting applications

Tube	Dash	Versil-Flare SAE 37° flare	Versil-Flare SAE 37° flareless	ORS-BR ORB	ORS-TF
0.19	-03	0.028 - 0.035	0.028 - 0.035	-	-
0.25	-04	0.028 - 0.065	0.028 - 0.065	0.028 - 0.065	0.028 - 0.065
0.31	-05	0.028 - 0.065	0.028 - 0.065	-	-
0.38	-06	0.028 - 0.065	0.028 - 0.095	0.035 - 0.083	0.028 - 0.065
0.50	-08	0.035 - 0.083	0.035 - 0.120	0.035 - 0.109	0.035 - 0.120
0.62	-10	0.035 - 0.095	0.035 - 0.120	0.035 - 0.120	0.035 - 0.095
0.75	-12	0.035 - 0.109	0.035 - 0.120	0.035 - 0.120	0.049 - 0.120
1.00	-16	0.035 - 0.120	0.035 - 0.134	0.049 - 0.148	0.049 - 0.134
1.25	-20	0.049 - 0.120	0.049 - 0.188	0.049 - 0.188	0.049 - 0.156
1.50	-24	0.065 - 0.120	0.065 - 0.188	0.065 - 0.188	0.065 - 0.188
2.00	-32	0.065 - 0.134	0.065 - 0.188	-	-

Recommended hydraulic tubing material specifications

Hydraulic tubing SAE specifications

Versil-Flare SAE 37° flared	Versil-Flare SAE 37° flareless	ORS-BR ORS	ORS-TF ORS
SAEJ524	SAEJ356	SAEJ356	SAEJ356
SAEJ525	SAEJ524	SAEJ524	SAEJ524
-	SAEJ525	SAEJ525	SAEJ525
-	SAEJ527	SAEJ526	SAEJ526

Hydraulic tubing material description

SAEJ356 electric resistance welded flash controlled low carbon steel, SAEJ524 seamless annealed low carbon steel, SAEJ525 electric resistance welded

cold worked annealed, SAEJ526 single wall welded low carbon steel (automotive), SAEJ527 brazed double wall low carbon steel (automotive). The maximum hardness of the above tubing should not exceed Rockwell B65.



Steel adapters

Assembly torque

J

Recommended parallel connection assembly torque

Eaton recommends that a torque wrench be used to assure proper fitting assembly of these connections.

The values listed are for steel connections.
Contact Eaton for torque values for other materials.

ORB low pressure with SAE 37° (SAE J1926-3)

Dash size	Thread size (inches)	Jam nut or straight fitting torque lb.-ft.	Jam nut or straight fitting torque newton meters
-03	3/8-24	8-9	12-13
-04	7/16-20	13-15	18-20
-05	1/2-20	14-15	19-21
-06	9/16-18	23-24	32-33
-08	3/4-16	40-43	55-57
-10	7/8-14	43-48	59-64
-12	1 1/16-12	68-75	93-101
-14	1 3/16-12	83-90	113-122
-16	1 5/16-12	112-123	152-166
-20	1 5/8-12	146-161	198-218
-24	1 7/8-12	154-170	209-230
-32	2 1/2-12	218-240	296-325

ORB high pressure with ORS (SAE J1926-2)

Dash size	Thread size (inches)	Jam nut or straight fitting torque lb.-ft.	Jam nut or straight fitting torque newton meters
-03	3/8-24	8-10	11-13
-04	7/16-20	14-16	20-22
-05	1/2-20	18-20	24-27
-06	9/16-18	24-26	33-35
-08	3/4-16	50-60	68-78
-10	7/8-14	72-80	98-110
-12	1 1/16-12	125-135	170-183
-14	1 3/16-12	160-180	215-245
-16	1 5/16-12	200-220	270-300
-20	1 5/8-12	210-280	285-380
-24	1 7/8-12	270-360	370-490

ORS (SAE J1453)

Dash size	Thread size (inches)	Swivel nut torque lb.-ft.	Swivel nut torque newton meters
-04	9/16-18	10-12	14-16
-06	11/16-16	18-20	24-27
-08	13/16-16	32-35	43-47
-10	1-14	46-50	62-68
-12	1 3/16-12	65-70	88-95
-16	1 7/16-12	92-100	125-136
-20	1 11/16-12	125-140	170-190
-24	2-12	150-165	204-224

SAE 37° (SAE J514)

Dash size	Thread size (inches)	Swivel nut torque lb.-ft.	Swivel nut torque newton meters
-04	7/16-20	11-12	15-16
-05	1/2-20	15-16	20-22
-06	9/16-18	18-20	24-28
-08	3/4-16	38-42	52-58
-10	7/8-14	57-62	77-85
-12	1 1/16-12	79-87	108-119
-16	1 5/16-12	108-113	148-154
-20	1 5/8-12	127-133	173-182
-24	1 7/8-12	158-167	216-227
-32	2 1/2-12	245-258	334-352

Recommended parallel connection assembly torque

Eaton recommends that a torque wrench be used to assure proper fitting assembly of these connections.

The values listed are for steel connections.
Contact Eaton for torque values for other materials.

Metric ISO 6149 (ISO 6149-2)

Thread size	Straight adapter or locknut torque	
	lb.-ft.	Newton meters
M10 x 1	13-15	18-20
M12 x 1.5	15-19	20-25
M14 x 1.5	19-23	25-30
M16 x 1.5	33-40	45-55
M18 x 1.5	37-44	50-60
M20 x 1.5	52-66	70-90
M22 x 1.5	55-70	75-95
M26 x 1.5	81-96	110-130
M27 x 2	96-111	130-150
M33 x 2	162-184	220-250
M42 x 2	170-192	230-260
M48 x 2	258-347	350-470

BSPP (ISO 1179-3)

Nominal thread size	Straight adapter or locknut torque	
	lb.-ft.	Newton meters
G 1/8-28	13-15	18-20
G 1/4-19	19-23	25-30
G 3/8-19	33-40	45-55
G 1/2-14	55-70	75-95
G 3/4-14	103-118	140-160
G 1-11	162-184	220-250
G 1 1/4-11	170-192	230-260
G 1 1/2-11	258-347	350-470

***"G" denotes parallel threads, other than ISO 6149. (Port connection only)

DKO Light Duty (ISO 8434-1 L)

DN size	Tube O.D.	Thread	DKO Light Duty (L)		
			Swivel Nut Hex Size	Swivel Nut Torque	Swivel Nut Torque
			ISO 8434-1	lb-ft 10%	Nm +10%
5	6	M12x1,5	14	15	20
6	8	M14x1,5	17	18	25
8	10	M16x1,5	19	33	45
10	12	M18x1,5	22	37	50
12	15	M22x1,5	27	44	60
16	18	M26x1,5	32	52	70
20	22	M30x2	36	96	130
25	28	M36x2	41	133	180
32	35	M45x2	50	221	300
40	42	M52x2	60	236	320

DKO Heavy Duty (ISO 8434-1 S)

DN size	Tube O.D.	Thread	DKO Heavy Duty (S)		
			Swivel Nut Hex Size	Swivel Nut Torque	Swivel Nut Torque
			ISO 8434-1	lb-ft +10%	Nm +10%
	6	M14x1,5	17	15	20
5	8	M16x1,5	19	26	35
6	10	M18x1,5	22	37	50
8	12	M20x1,5	24	48	65
10	14	M22x1,5	27	52	70
12	16	M24x1,5	30	63	85
16	20	M30x2	36	100	135
20	25	M36x2	41 (46)	125	170
25	30	M42x2	50	207	280
32	38	M52x2	60	236	320

Steel adapters

Assembly instructions

J

ORS tube fittings, pipe threads and SAE 37° tube fittings

Assembly instruction for ORS Tube Fittings

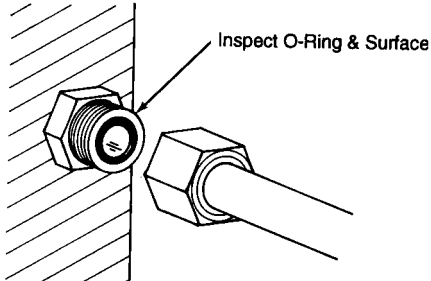

1. Inspect sealing surfaces and O-Ring groove for damage or foreign material. Check the O-Ring to insure that it is properly seated in the O-Ring groove.

Align fittings

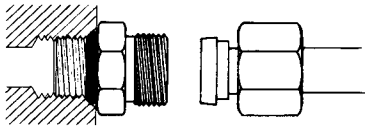

Hand tighten

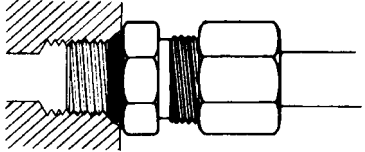

2. Lubricate threads with heavy lubricant (such as part number 222070 Lube).
3. Align the ORS Tube Fitting to the flat sealing connections and tighten the nut by hand. The nut should tighten easily by hand if properly aligned.

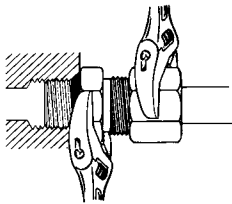

4. Complete the assembly by wrench tightening the nut to the recommended torque value on page J-22.

Assembly instructions for Pipe Threads

1. Assemble connection hand tight.

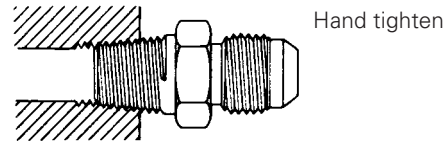

2. Mark male and female.

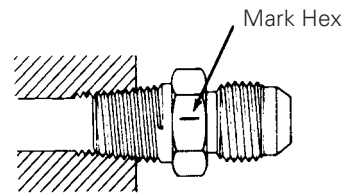

3. Rotate male; 1-1/2 turns if using thread sealant. 2 turns if not using thread sealant.

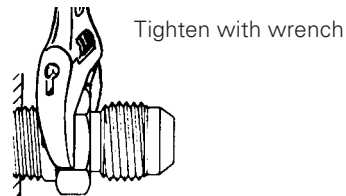

ORS tube fittings, pipe threads and SAE 37° tube fittings

continued

Assembly instructions for standard SAE 37° flare type tube fitting

Use SAE J524 or SAE J525 tubing for best bending and flaring results.

1. Cut the tubing with a tube cutter. If a fine tooth hacksaw is used, make sure cut-off is square; remove burrs with deburring tool, emery paper or fine file. Clean all dirt and grit from the I.D. and O.D. of the tube.
2. Place the nut and then the sleeve onto tube. The threaded end of nut and flared end of sleeve must face the end of tube.

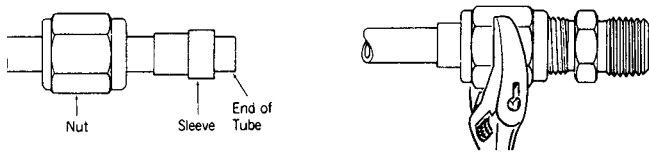

3. Flare the tube end with a flaring tool to provide a SAE 37° flare. Check the flare for correct diameter, excessive thin out and burrs or cracks.
4. Lubricate all mating surfaces of nut, ferrule and body with a heavy lubricant such as 222070 Lube.
5. Assemble the nut and sleeve to body. Turn the nut hand tight then wrench tighten for a leakproof joint. See page J-22, torque values, for assembly using a torque wrench.

The Eaton standard SAE 37° flare fitting is easy to disassemble and may be reassembled repeatedly.

Cutting

To insure a leak-proof joint, the tubing should be cut square ($\pm 1^\circ$). A tube cutter is preferred, but a hacksaw or abrasive wheel can be used.



Out of Square Cut



Square Cut

Deburring

All cut tubes should be deburred. However, deburring is even more important if the tubing was cut with a hacksaw or abrasive wheel. Remove any burrs, both internally and externally, with a deburring tool, emery paper or fine file.

Clean the tube before assembly. Clean all dirt and grit from the I.D. and O.D. of the tube.

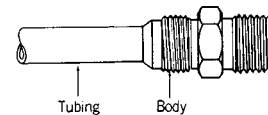
Assembly instructions for Versil-Flare tube fitting**Tubing cut-off**

1. Tube should be cut to fit tight against the face of standard SAE 37° flare body.

Initial assembly

1. Deburr the end internally and externally. Clean all dirt and grit from I.D. and O.D.
2. Slide the nut and then the ferrule into the tube. Make sure the tapered end of ferrule points toward the nut.

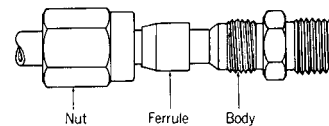

3. Lubricate all mating surfaces of nut, ferrule and body with a heavy lubricant such as 222070 Lube.
4. Place end of tube against standard SAE 37° flare body.
5. Slide the ferrule and nut against body and tighten the nut onto the body "Hand Tight." Mark the nut in relation to the body for location.

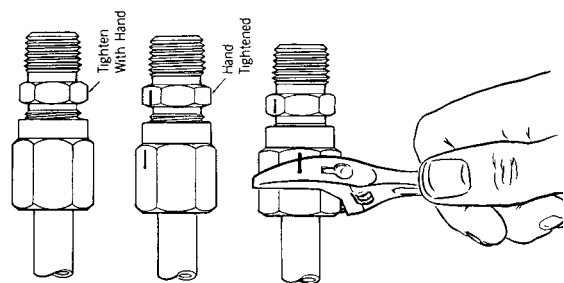

6. Hold tube against body and tighten nut a total of 1-1/4 turns on -3 through -10 and 1-1/2 turns -12 through -32.

Reassembly

1. Slide nut against the body and tighten to "Hand tight." Mark the nut for location.
2. Tighten nut a minimum of one "Hex" flat. The Versil-Flare flareless tube fitting is designed for a maximum of 10 reassemblies.

Steel adapters

Assembly instructions

J

Adjustable SAE O-Ring boss assembly instructions

On SAE, and BSPP threads without retaining washer

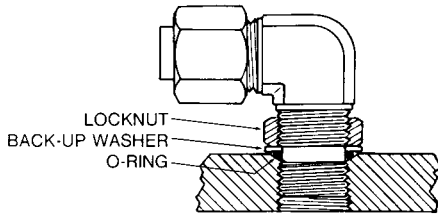

On BSPP threads with check washer

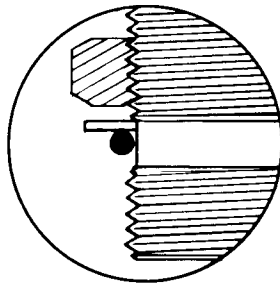
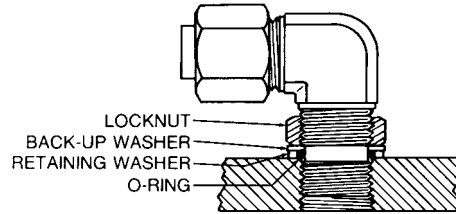

The O-Ring and back-up washer should be in the proper position on non-threaded section nearest to locknut. Lubrication of the O-Ring is recommended.

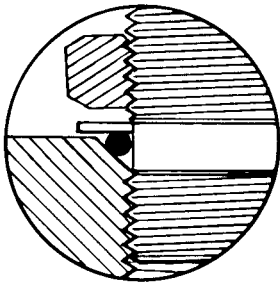
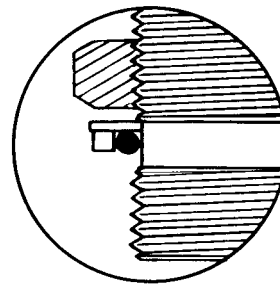

Tighten the fitting by hand into the straight threaded boss until back-up washer contacts face of boss (left) or retaining washer when thread is BSPP (right.)

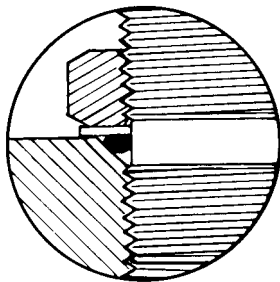
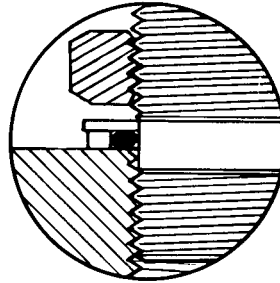

In order to position the fitting, unscrew up to one full turn then hold fitting in desired position and tighten locknut so that the back-up washer contacts face of boss and forces the O-Ring within boss cavity. With BSPP threads use same procedure. The difference between the two thread types exist in the retaining washer being in contact with face of boss (right inset). Assemble to the respective assembly torque specified on page J-22.

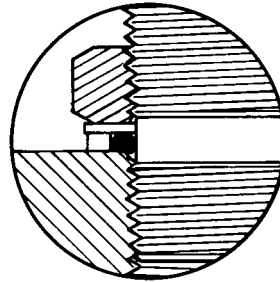

How to read adapter part numbers

Adapter part numbers

Adapter part numbers consist of a base number followed by a size designation. If the part number contains a "T" character between the base number and size designator, the first size designator signifies the tube size.

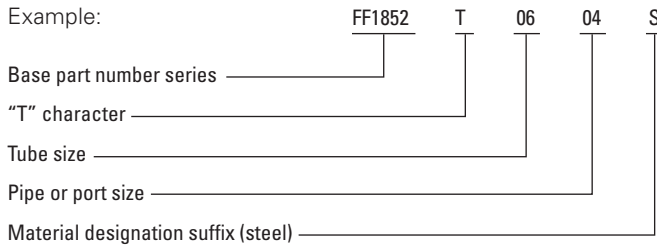

If the part number does not contain a "T" character between the base number and the size description, the first size designation signifies the port size.

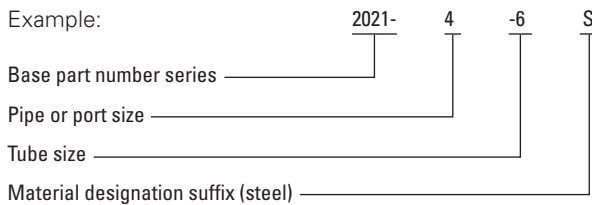

How to order adapters

Adapters are ordered using the complete part number as shown on the adapter pages.

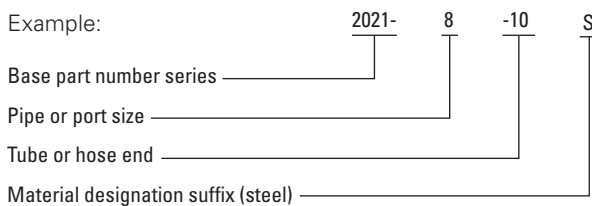

ORS adapters conversion*

ORS adapters come standard with the half dovetail groove design. The half dovetail groove is manufactured with an angle on the OD wall. This angle captures the O-Ring for maximum retention. For ease of installation, a half dovetail groove installation tool may be used.

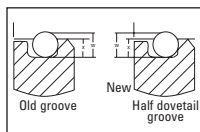

*Eaton reserves the right to use straight groove on some ORS.

Half dovetail groove installation tool

The half dovetail groove installation tool compresses the O-Ring, allowing it to easily slide into the groove in the adapter. Use of the tool maximizes efficiency and minimizes any fatigue that may be associated with repeated insertions over an extended period of time. One tool is required per dash size (or by adapter size). Each tool comes with an illustrated instruction sheet. Tools are available by using the following part numbers: FT1405-04, FT1405-06, FT1405-08, FT1405-10, FT1405-12, FT1405-16, FT1405-20, FT1405-24.



How to order ORS adapters and tube fittings

ORS tube fitting body with O-Ring, locknut and washer, where applicable.

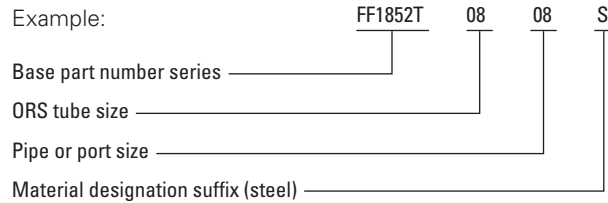

ORS tube fitting body without O-Ring

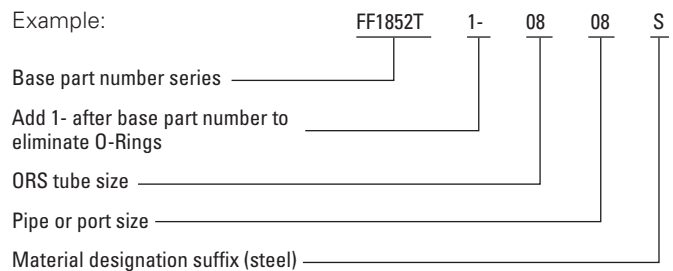

ORS bulkhead tube fitting body without bulkhead nut or O-Ring

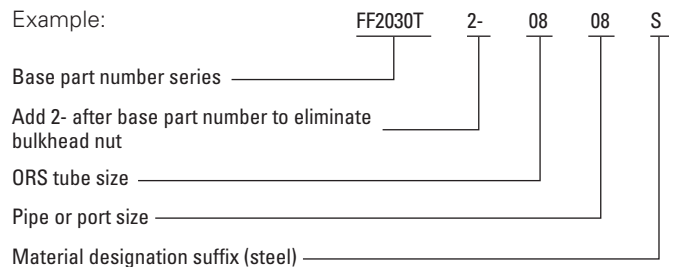

ORS-TF tube fitting components

ORS-TF tube fittings, nut, ferrules, and sleeves can be ordered under the following kit part number:

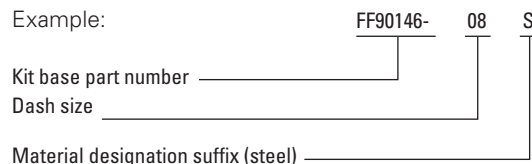

By ordering a single part number in kit form, you will receive the components ready to be assembled to an ORS tube fitting body:

- Example: FF90146-08S includes:
- FC1851-08S (ORS-TF Nut)
 - FF90102-08S (ORS-TF Ferrule)
 - FF90103-08S (ORS-TF Sleeve)

Steel adapters

Part structure

How to order ORS adapters and tube fittings

(continued)

Nuts and shoulders (Braze type)

Nuts and shoulders can be ordered separately. Simply use the base number, dash size, and material designation.

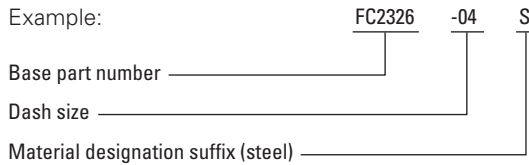

O-Rings

Buna-N O-Rings are standard. Other materials may also be specified by adding a material designator prefix if the part number begins with a numeric, and a material designator suffix if the part number begins with an alpha character. In all cases, the suffix "S" shall be omitted.

Material designation prefix/suffix	Material	Operating temperature range
S	90 Durometer Buna-N Nitrile Rubber	-40°F to +250°F (-40°C to +121°C)
212	80 Durometer EPDM Ethylene propylene diene monomer	-65°F to +300°F (-55°C to +150°C)
213	90 Durometer Viton Fluoroelastomer	-15°F to +400°F (-26°C to +204°C)
214	90 Durometer Buna-N Low temperature Nitrile	-65°F to +225°F (-55°C to +100°C)
352	70 Durometer Neoprene	-65°F to +300°F (-55°C to +150°C)

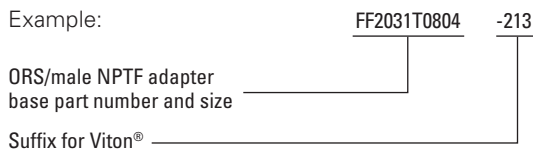

O-Rings can be ordered separately

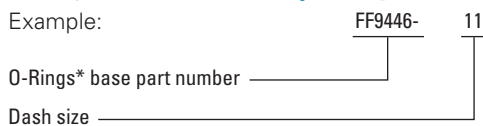

*See ORS O-Ring chart on page J-115-117.

Body material

Steel is standard. Other materials may also be specified by adding a material designator prefix if the part number begins with a numeric, and a material designator suffix if the part number begins with an alpha character. In all cases, the suffix "S" shall be omitted.

Material designation prefix/suffix	Material
B (suffix only)	Brass
259	316-Stainless
4	Monel®
S	Steel

How to order Conversion adapters BSPP/BSPT

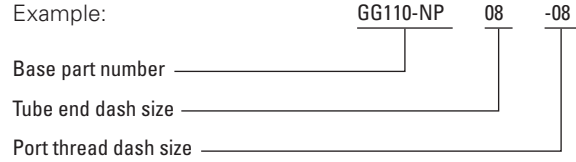

Metric

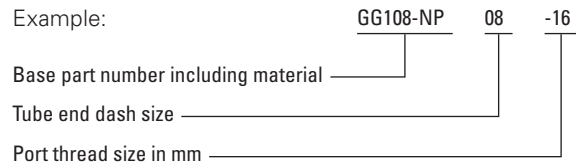

Dimensions

Eaton tube fittings are ordinarily designed and produced to the functional requirements set forth in SAE Standards J512, J513, J514, J1926 and J1453. However, in some cases the envelope dimensions of certain components vary slightly from cataloged or SAE referenced dimensions. The SAE reference numbers and fitting descriptions given are in accordance with SAE Standard J846.

Availability

All items listed in the current price schedule are normally carried in stock. Price and delivery of non-stocked and special parts may be obtained from your Eaton Sales Representative or Distributor.

Loctite™ Vibra-Seal 516 for external pipe threads

Loctite Vibra-Seal has the following characteristics:

- Non-hardening thread sealant
- Resists shredding and peeling during assembly
- Can be reused up to 5 times without recoating
- Provides resistance to vibrational loosening
- Excellent resistance to solvents and oils
- Operating temperatures range -65°F to +250°F

Machine applied so that it leaves first 1/2 to 2 threads uncovered for ease of assembly. Because of the excellent characteristics of this product, we are offering Loctite Vibra-Seal on all of our parts that have male pipe threads. Factory applied Loctite for external pipe threads may be ordered for steel parts by adding the prefix "307-" to the completed part number, and dropping suffix "S" if the part number begins with a numeral. Example: 307-2021-8-8.

If the part number begins with an alpha character, add the suffix "-307" to the completed part number and drop the suffix "S". Example: FF2031T0606-307.

Loctite is a trademark of The Henkel Corporation.
Viton is a trademark of The Chemours Company FC, LLC.
Monel is a registered trademark of Special Metals Corporation group of Companies.

ORS-TF

FC1851
Page J-40

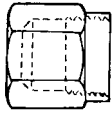

FF90102
Page J-40



FF90103
Page J-40



ORS braze type

FC1229
(former WH 4165x)
Page J-41

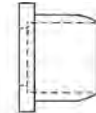

FC2325
Page J-41

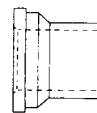

FF1922T
Page J-42

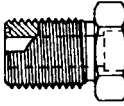

FF1851T
Page J-42



ORS braze type (Continued)

FF1856T
Page J-42

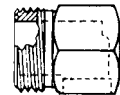

FF1858T
Page J-43

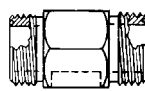

FF2115T
Page J-43

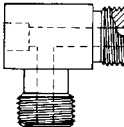

FC2326
(former WH 4105x)
Page J-43



ORS/SAE O-Ring boss

FF1852T
(former WH 4315x)
Page J-44

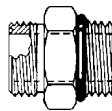

F2211T
Page J-45



FF1854T
(former WH 4316x)
Page J-45

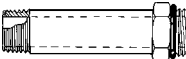

FF2130T
Page J-45

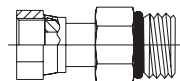

ORS/SAE O-Ring boss (Continued)

FF1868T
(former WH 4515x)
Page J-46

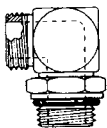

FF2227T
(former WH 4515x-L)
Page J-47

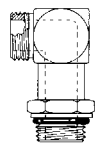

FF2068T
(former WH 4365x)
Page J-47

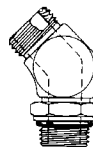

ORS/SAE O-Ring boss (Continued)

FF1861T
(former WH 4715x)
Page J-48

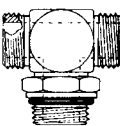

FF1865T
(former WH 4716x)
Page J-48

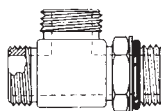

ORS-NPTF

FF2031T
(former WH 4205x)
Page J-49

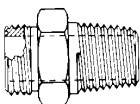

FF2093T
(former WH 4355x)
Page J-49

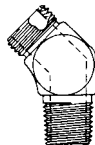

FF2032T
(former WH 4405x)
Page J-50

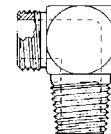

FF2001T
Page J-50

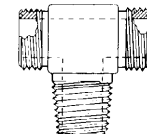

ORS to SAE 37° flare

FF2209T
(former WH 4213x)
Page J-51

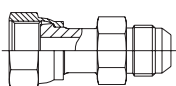

FF2313T
Page J-51

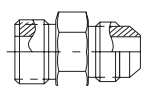

Items in parentheses are equivalent to former Weatherhead part series.

Steel adapters

Configuration index

J

ORS/ORS

FF2000T
(former WH
4305x)
Page J-52

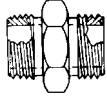

FF2281T
Page J-52

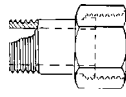

FF1994T
(former WH
4325x)
Page J-53

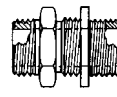

FF2133T
Page J-53

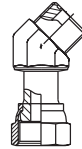

ORS/ORS (Continued)

FF2144T
Page J-53

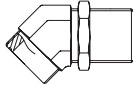

FF2098T
(former WH
4506x)
Page J-53

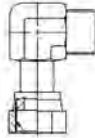

FF2035T
(former WH
4505x)
Page J-54

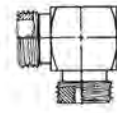

ORS/ORS (Continued)

FF2030T
(former WH
4525x)
Page J-54

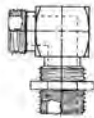

FF1898T
(former WH
4706x)
Page J-54

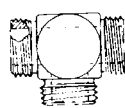

FF2174T
(former WH
4726x)
Page J-55

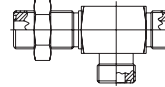

ORS/ORS (Continued)

FF1857T
(former WH
4707x)
Page J-55

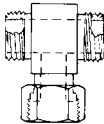

FF2114T
(former WH
4706x)
Page J-55

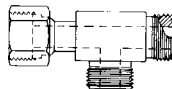

FF2033T
Page J-55

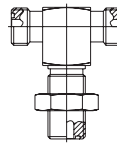

ORS accessories

FF9768
(former WH
4924x)
Page J-56



FF9767T
(former WH
4229x)
Page J-56



FF9863
(former WH
4129x)
Page J-56

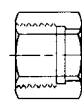

ORS accessories (Continued)

FF9766
Page J-57



FF9075
ORS silver
braze ring
Page J-57



SAE O-Ring boss/SAE O-Ring boss

FF1010
(former WH
7033x)
Page J-58



900598
(former WH
7237x)
Page J-58



FF2138
(former WH
7238x)
Page J-59

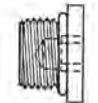

2220
(former WH
C5314x)
Page J-59

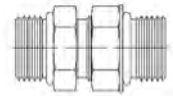

SAE O-Ring boss/SAE O-Ring boss (Continued)

FF1796 (former
WH C3249x)
Page J-59

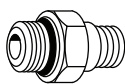

2229
Page J-60



FF2591
Page J-60

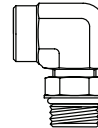

FF1167
Page J-60

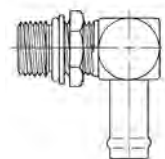

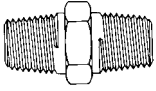
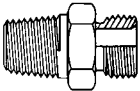
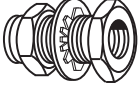
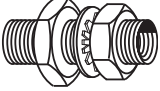

Items in parentheses are equivalent to former Weatherhead part series.

Pipe to pipe

2083 (former WH C3069x) Page J-61		2015 Page J-61		FF4183 (former WH W series) Page J-62		FF4185 (former WH W series) Page J-62	
---	---	-------------------	---	---	--	---	---

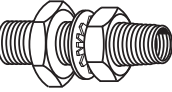
Pipe to pipe (Continued)

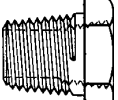
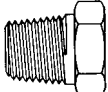
FF4186 (former WH W series) Page J-62		2084 Page J-63		2081 (former WH C3109x) Page J-63		2082 (former WH C3159x) Page J-64	
---	---	-------------------	---	---	--	---	---

Pipe to pipe (Continued)

FF4177 (former WH C3179x) Page J-64		FF91494 (former WH C3059x) Page J-64		2222 (former WH C3109x) Page J-65		2040 (former WH C3209x) Page J-65	
---	---	--	---	---	--	---	---

Pipe to pipe (Continued)

2045 (former WH 9205x) Page J-66		2046 (former WH 9255x) Page J-66		2096 (former WH C3309x) Page J-67		2247 Page J-67	
--	--	--	--	---	---	-------------------	--

Pipe to pipe (Continued)

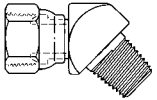
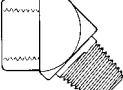
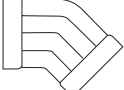
2050 (former WH 9385x) Page J-67		2049 (former WH 9355x) Page J-68		2088 (former WH C3359x) Page J-68		2086-S (former WH C3559x) Page J-69	
--	---	--	---	---	--	---	---

Pipe to pipe (Continued)

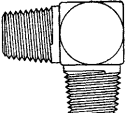
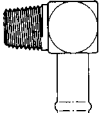
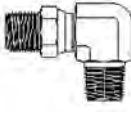
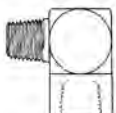
2085 (former WH C3529x) Page J-69		FF1162 Page J-70		2251 (former WH 9435x) Page J-70		2089 (former WH C3409) Page J-70	
---	---	---------------------	---	--	--	--	---

Pipe to pipe (Continued)

2252 Page J-71		2048 (former WH 9455) Page J-71		2047 (former WH 9405x) Page J-72		FF4175 (former WH 9405xLL) Page J-72	
-------------------	---	---------------------------------------	---	--	--	--	---

Pipe to pipe (Continued)

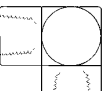
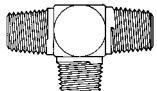
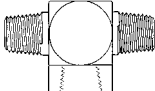
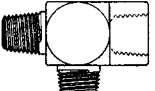
2087 (former WH C3509x) Page J-73		2257 Page J-73		2256 Page J-74		2093 (former WH C3805x) Page J-74	
---	---	-------------------	---	-------------------	--	---	---

Items in parentheses are equivalent to former Weatherhead part series.

Steel adapters

Configuration index

Pipe to pipe (Continued)

2092
(former WH
C3759x)
Page J-74

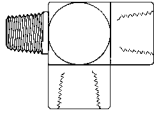

2254
(former WH
9406x)
Page J-75

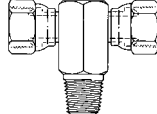

2255
(former WH
9705x)
Page J-75

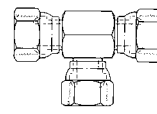

2253
(former WH
9456x)
Page J-75

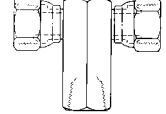

Pipe to pipe (Continued)

2091
(former WH
C3609x)
Page J-76

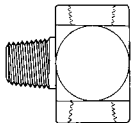

2090
(former WH
C3709x)
Page J-76

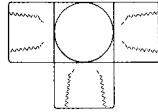

2080
(former WH
C3959x)
Page J-76

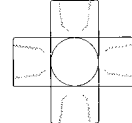

Pipe to SAE 37° flare

2021
(former WH
C5205x)
Page J-77

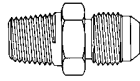

2240
Page J-78

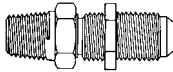

202113
Page J-78

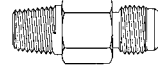

202114
Page J-78

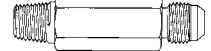

Pipe to SAE 37° flare (Continued)

2239
(former WH
C5275x)
Page J-79

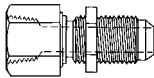

2018
(former WH
9100x)
Page J-79

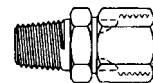

2242
(former WH
C5256x)
Page J-79

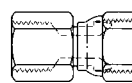

2022
(former WH
C5255x)
Page J-80

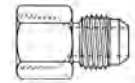

Pipe to SAE 37° flare (Continued)

2044
Page J-80

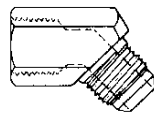

2023
(former WH
C5355x)
Page J-81

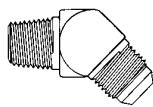

2243
Page J-81

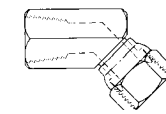

2024
(former WH
C5405x)
Page J-82

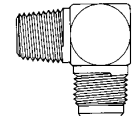

Pipe to SAE 37° flare (Continued)

202411
(former WH
C5425x)
Page J-83

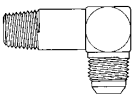

202413
(former WH
C5435x)
Page J-83

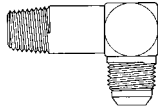

202414
Page J-84

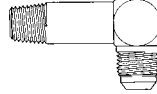

2250
(former WH
C5406x)
Page J-84

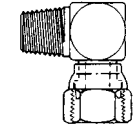

Pipe to SAE 37° flare (Continued)

2249
Page J-84

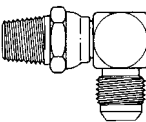

2244
Page J-85

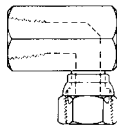

2025
(former WH
C5455x)
Page J-85

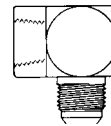

203007
Page J-85

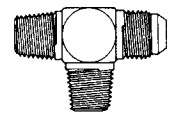

Pipe to SAE 37° flare (Continued)

203301
Page J-86

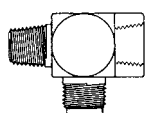

203103
Page J-86

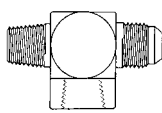

2028
(former WH
C5755x)
Page J-86

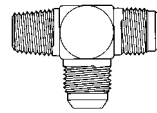

203006
Page J-87

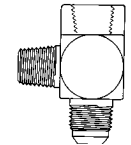

Items in parentheses are equivalent to former Weatherhead part series.

Pipe to SAE 37° flare (Continued)

2030
(former WH
C5605x)
Page J-87

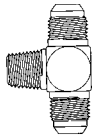

202901
Page J-87

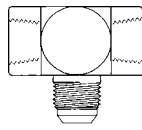

203104
Page J-87

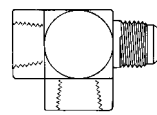

2029
(former WH
C5805x)
Page J-88

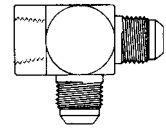

Pipe to SAE 37° flare (Continued)

2031
(former WH
5655x)
Page J-88

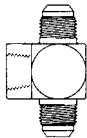

202003
Page J-88

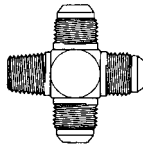

Pipe to 45° flare - Brass

2000
Page J-89

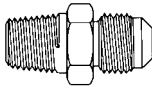

2001
Page J-89

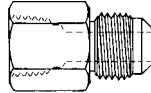

2007
Page J-90

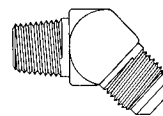

Pipe to 45° flare - Brass (Continued)

2002
Page J-90

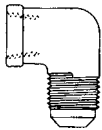

2003
Page J-90

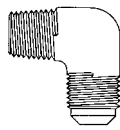

Pipe to SAE O-Ring boss

2246
(former WH
C3239x)
Page J-91

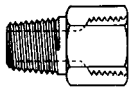

2066
(former WH
9315x)
Page J-91

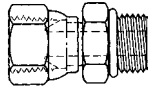

2216
(former WH
C3269x)
Page J-92

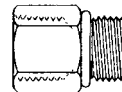

2067
(former WH
9365x)
Page J-92

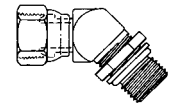

Pipe to SAE O-Ring boss (Continued)

2068
(former WH
9515x)
Page J-93

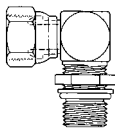

206801
(former WH
C3459x)
Page J-93

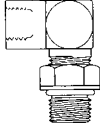

206804
(former WH
C3469x)
Page J-93

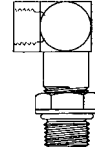

Pipe to braze and weld

73056
Page J-94

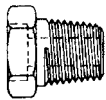

FF1159
Page J-94

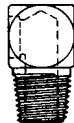

SAE 37° (JIC) flare union

2027
(former WH
C5305x)
Page J-94

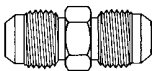

202712
(former WH
C5306x)
Page J-95

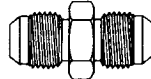

2041
(former WH
C5325x)
Page J-95

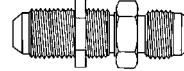

900599
(former WH
C5229x)
Page J-95

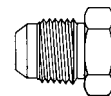

Items in parentheses are equivalent to former Weatherhead part series.

Steel adapters

Configuration index

J

SAE 37° (JIC) flare union (Continued)

210292
(former WH
C5129x)
Page J-96



2215
(former WH
C5015x)
Page J-96

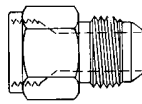

221501
(former WH
C5015x)
Page J-97

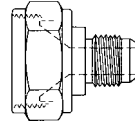

2042
(former WH
C5375x)
Page J-97

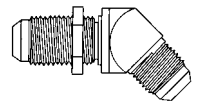

SAE 37° (JIC) flare union (Continued)

2070
(former WH
C5356x)
Page J-97

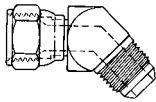

2039
(former WH
C5505x)
Page J-98

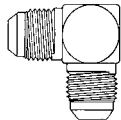

2043
(former WH
C5525x)
Page J-98

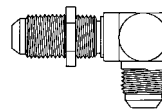

2071
(former WH
C5506x)
Page J-98

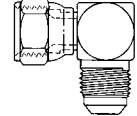

SAE 37° (JIC) flare union (Continued)

FF5163
Page J-99

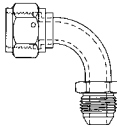

500454
Page J-99

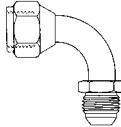

504095
Page J-99

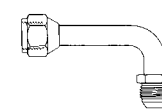

FF5164
Page J-100

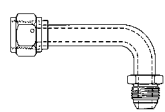

SAE 37° (JIC) flare union (Continued)

2033
(former WH
5705x)
Page J-100

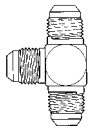

203002
(former WH
C5725x)
Page J-100

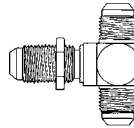

203008
Page J-101

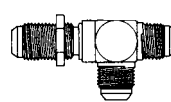

203101
(former WH
C5707x)
Page J-101

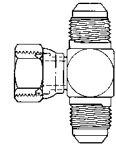

SAE 37° (JIC) flare union (Continued)

203102
(former WH
C5706x)
Page J-101

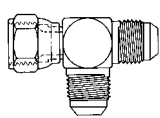

2020
(former WH
C5955x)
Page J-102

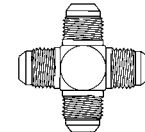

210212
(former WH
C5924x)
Page J-102



SAE 45° flare union

2056
Page J-103



2060
Page J-103

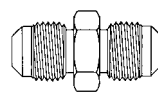

FF4174
(former WH
9154x)
Page J-103

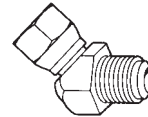

SAE O-Ring boss to SAE 37° flare

202702
(former WH
C5315x)
Page J-104-105

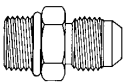

202713
(former WH
C5316x)
Page J-105

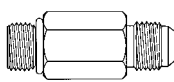

2266
(former WH
C5216x)
Page J-105

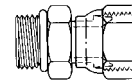

2061
(former WH
C5365x)
Page J-106

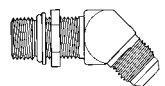

SAE O-Ring boss to SAE 37° flare (Continued)

206209
(former WH
C5515xLL)
Page J-106

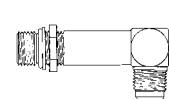

2062
(former WH
C5515x)
Page J-107

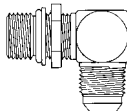

203005
(former WH
C5716x)
Page J-108

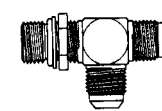

203003
(former WH
C5715x)
Page J-108

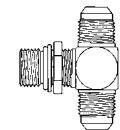

FF3910
(former WH
C5515xL)
Page J-106

Items in parentheses are equivalent to former Weatherhead part series.

SAE split flange to ORS

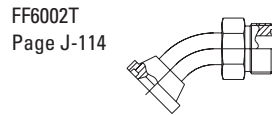
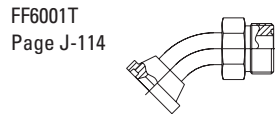
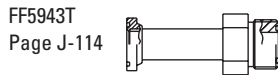

SAE split flange to ORS (Continued)

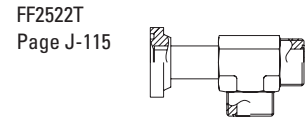
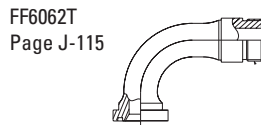

SAE split flange to SAE 37° flare

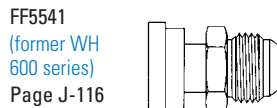
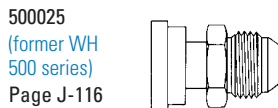

SAE split flange to SAE 37° flare (Continued)

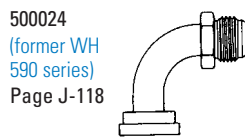

SAE split flange to SAE 37° flare (Continued)

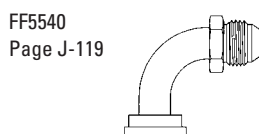
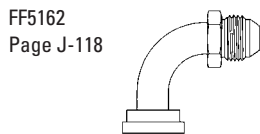

SAE swivel flange to SAE split flange

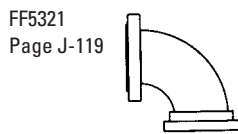
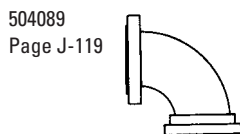

SAE flareless to 37° union

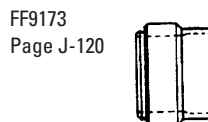
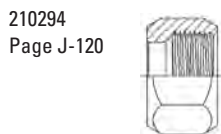

Braze and weld to split flange

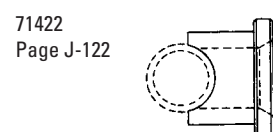
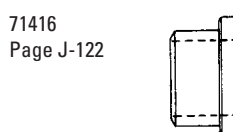
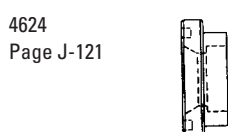
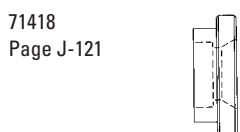

Items in parentheses are equivalent to former Weatherhead part series.

Steel adapters

Configuration index

J

Braze and weld to split flange (Continued)

FC1102
Page J-122



FC1132
Page J-122



Braze and weld to SAE 37° flare

202232
Page J-123

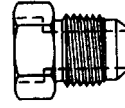

73014
Page J-123

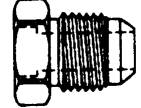

Versil-Flare™ - flareless and flare

FC2875
Page J-126

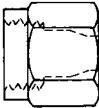

FF9605
Page J-126

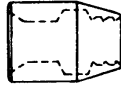

221000
(former WH C5115x)
Page J-126



1290
(former WH C5105x)
Page J-127

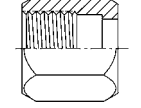

Versil-Flare™ (Continued)

900605
(former WH C5165x)
Page J-127



Specials

2004
(former WH C92 series)
Page J-128

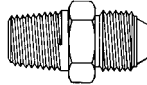

202124/FF1327
(former WH C5880x)
Page J-128

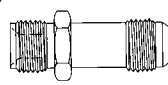

200001
Page J-128

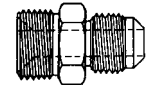

Specials (Continued)

FF1353/FF1354
Page J-129

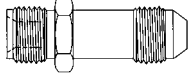

FF1980
Page J-129

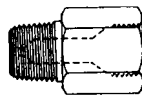

FF1981
Page J-129

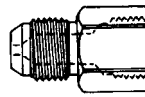

FF4184
(former WH 41157x)
Page J-129

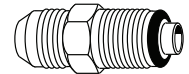

Metric to SAE 37° flare

15.063
(former WH MC5206x)
Page J-131

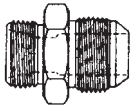

15.147
(former WH MC5208x)
Page J-131

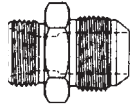

15.117
(former WH MC5207x)
Page J-131

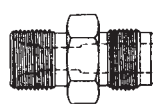

15.164
Page J-132

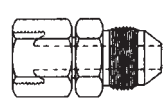

Metric to SAE 37° flare (Continued)

FF4215
(former WH M41157x)
Page J-132

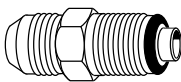

15.163
Page J-132

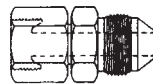

15.165
Page J-133

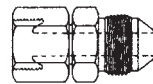

Metric to SAE 37° flare (Continued)

GG108-NP
(former WH MC5315x)
Page J-133

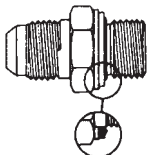

GG308-NP
(former WH MC5515x)
Page J-133

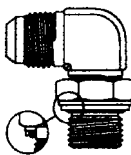

ORS to metric

FF2485T
Page J-134

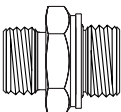

FF2742T
Page J-134

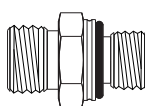

FF2744T
Page J-134

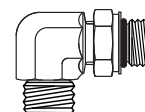

Items in parentheses are equivalent to former Weatherhead part series.

Metric sleeve

FF91488
(former WH
C5165x_M)
Page J-135



Pipe to metric

FF4180
(former WH
M9700x)
Page J-135

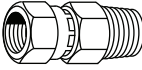

BSPP to SAE 37° flare

2063
Page J-136



GG106-NP
(former WH
MB5315x)
Page J-136

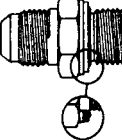

GG306-NP
(former WH
MB5515x)
Page J-137

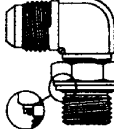

FF4179
(former WH
M9600x)
Page J-137



BSPT to SAE 37° flare

GG110-NP
(former WH
MC5205x)
Page J-137



GG310-NP
(former WH
MC5405x)
Page J-138

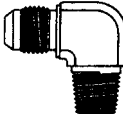

FF4181
(former WH
M9800x)
Page J-138



JIS 30° to SAE 37° flare

FF2593
Page J-138

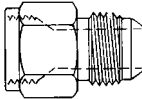

Stainless steel - Pipe to pipe

259-2083
(former WH
3081x)
Page J-61

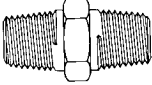

259-2081
(former WH
3121x)
Page J-63



259-2082
(former WH
3171x)
Page J-64



259-2096
(former WH
3321x)
Page J-67



Stainless steel - Pipe to pipe (Continued)

259-2089
(former WH
3421x)
Page J-70



259-2087
(former WH
3521x)
Page J-73



259-2091
Page J-76

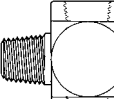

Stainless steel - Pipe to SAE 37° flare

259-2021
(former WH
5217x)
Page J-77

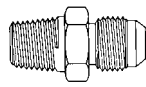

259-2240
Page J-78

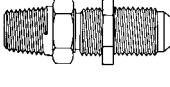

259-2022
(former WH
5267x)
Page J-80



Stainless steel - Pipe to SAE 37° flare (Continued)

259-2023
(former WH
5367x)
Page J-81

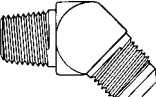

259-2024
(former WH
5417x)
Page J-82

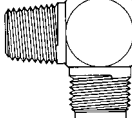

Stainless steel - SAE 37° (JIC) flare union

259-2027
(former WH
5317x)
Page J-94

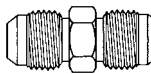

259-2041
(former WH
5337x)
Page J-95

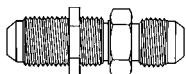

Stainless steel - SAE 37° (JIC) flare union (Continued)

259-900599
(former WH
C5241x)
Page J-95

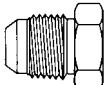

259-210292
(former WH
5141x)
Page J-96



259-2071
(former WH
5518x)
Page J-98

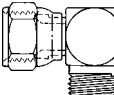

259-210212
(former WH
7936x)
Page J-102



Items in parentheses are equivalent to former Weatherhead part series.

Steel adapters

Configuration index

J

Stainless steel - SAE O-Ring to SAE 37°

259-202702
(former WH 5327x)
Page J-104-105

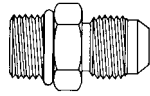

Stainless steel - Versil-Flare™ flareless and flare

259-1290
(former WH 5117x)
Page J-127

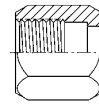

259-900605
(former WH 5177x)
Page J-127



Ermeto

7165X
Page J-144



8165X
Page J-144



7105X
Page J-144



8112X
Page J-144



Ermeto (Continued)

7129X
Page J-145



7229X
Page J-145



7015X
Page J-145

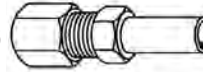

7305X
Page J-146

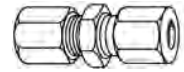

Ermeto (Continued)

7306X
Page J-146

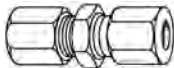

7325X
Page J-146

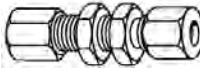

7205X
Page J-147

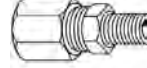

7255X
Page J-147

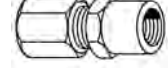

Ermeto (Continued)

7315X
Page J-148

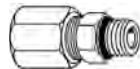

7355X
Page J-148



7505X
Page J-148



7405X
Page J-149



Ermeto (Continued)

7455X
Page J-149



7515X
Page J-150



7705X
Page J-150

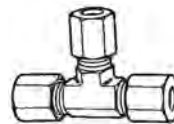

Ermeto (Continued)

7755X
Page J-150

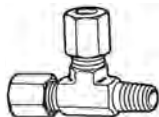

7805X
Page J-151

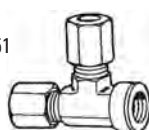

7716X
Page J-151

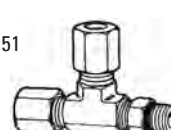

Ermeto (Continued)

7605X
Page J-152

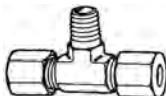

7655X
Page J-152

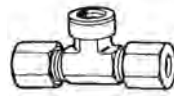

Reminder – different types of adapters have different part number configurations.

See Page J-27 for instructions and examples of how to read and order different part number configurations.

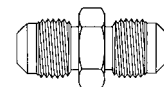

SAE

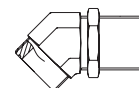

ORS

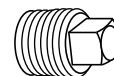

Pipe

Items in parentheses are equivalent to former Weatherhead part series.

ORS connections

The Eaton ORS™ connection is the universal answer to troublesome fluid leakage problems

ORS connection hose assembly

The ORS connection can be used with flexible hydraulic hose, combining the reusability of the hose fitting and the ORS connection. The result is the ultimate reusable fitting.

ORS connection hose assembly

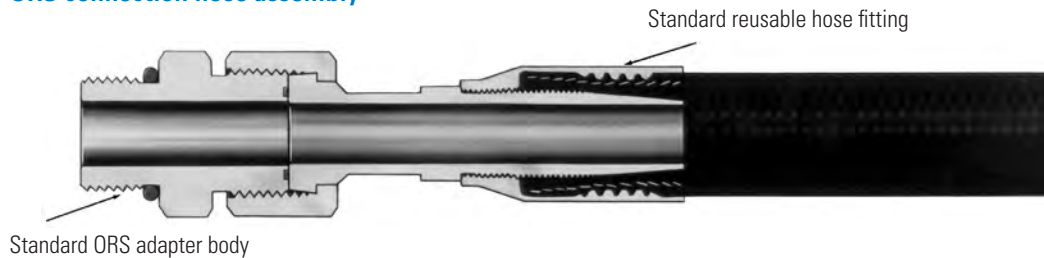

ORS Tube assemblies

The ORS connection can be attached to hydraulic tubing to make a tube assembly.

Two methods of attachment are available:

- **ORS-TF:** The ORS female can be jointed directly to steel tubing with the ORS-TF (wedge-type) tube fitting, another Eaton innovation. The fitting becomes an integral part of your system at a fraction of the time and expense brazing requires. The versatility these options provides make ORS the only connection you need for high-pressure situations. It attaches to most types of fluid conveying lines, controlling most types of fluid, facing the toughest conditions.
- **ORS-braze type:** The ORS component can be brazed to hydraulic tubing

ORS-TF tube assembly

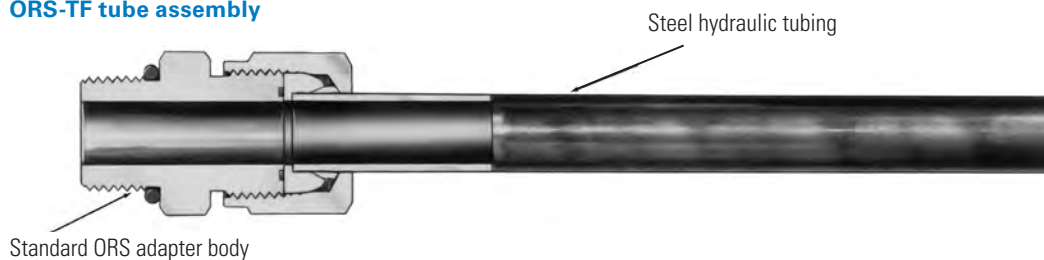

ORS-braze type tube assembly

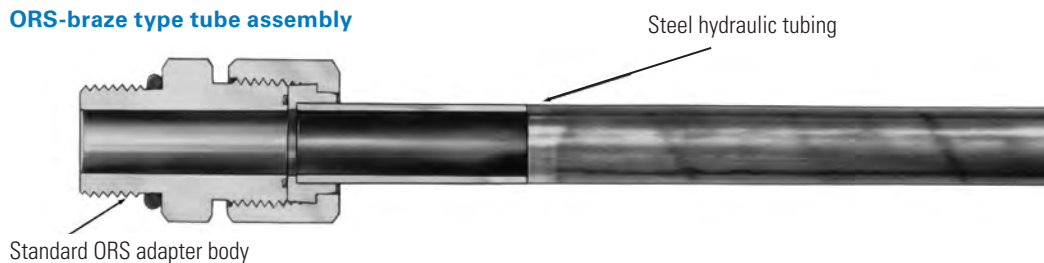

Steel adapters

ORS-TF tube fittings

J

ORS-TF tube fittings

The ORS-TF tube fitting utilizing the ORS-TF nut, ferrule and sleeve can be joined directly to steel tubing to solve your fluid leakage problems. It does not require the time and expense of brazing and provides the advantage of repetitive reuse. It is a compression type fitting that works on a variety of tubing.

Keep it simple and clean with ORS

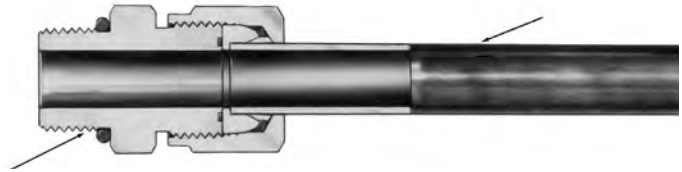

ORS-TF kit FF90146-(Size)

Includes:

- FC1851 ORS-TF Nut
- FF90102 ORS-TF Ferrule
- FF90103 ORS-TF Sleeve

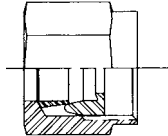

ORS-TF Nut

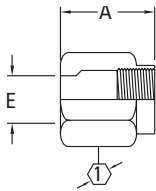

FC1851-(Dash size)

Dash size	Tube O. D.		Thread T1	A		E		①	
	mm	in		mm	in	mm	in	mm	in
04S	6,3	0.25	9/16-18	21,3	0.84	6,6	0.26	17,5	0.69
06S	9,6	0.38	11/16-16	23,6	0.93	9,6	0.38	20,6	0.81
08S	12,7	0.50	13/16-16	26,9	1.06	12,9	0.51	23,9	0.94
10S	16,0	0.63	1-14	28,7	1.13	16,0	0.63	28,4	1.12
12S	19,0	0.75	1 3/16-12	32,5	1.28	19,3	0.76	35,0	1.38
16S	25,4	1.00	1 7/16-12	34,3	1.35	25,6	1.01	41,1	1.62
20S	31,7	1.25	1 11/16-12	35,8	1.41	32,0	1.26	47,7	1.88
24S	38,1	1.50	2-12	37,3	1.47	38,3	1.51	57,1	2.25

ORS-TF Ferrule

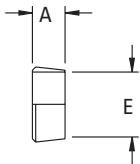

FF90102-(Dash size)

Dash size	Tube O. D.		A		E	
	mm	in	mm	in	mm	in
FF90102-04S	6,3	0.25	6,3	0.25	6,6	0.26
FF90102-06S	9,6	0.38	6,3	0.25	9,6	0.38
FF90102-08S	12,7	0.50	7,6	1.50	12,9	0.51
FF90102-10S	16,0	0.63	7,6	1.50	16,0	0.63
FF90102-12S	19,0	0.75	7,6	1.50	19,3	0.76
FF90102-16S	25,4	1.00	7,6	1.50	25,6	1.01
FF90102-20S	31,7	1.25	7,6	1.50	32,0	1.26
FF90102-24S	38,1	1.50	7,6	1.50	38,3	1.51

ORS-TF Sleeve

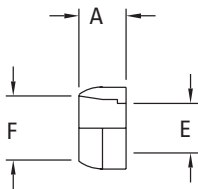

FF90103-(Dash size)

Dash size	Tube O. D.		A		E		F	
	mm	in	mm	in	mm	in	mm	in
FF90103-04S	6,3	0.25	8,1	0.32	4,3	0.17	6,3	0.25
FF90103-06S	9,6	0.38	8,6	0.34	6,6	0.26	9,6	0.38
FF90103-08S	12,7	0.50	9,4	0.37	9,6	0.38	12,7	0.50
FF90103-10S	16,0	0.63	10,2	0.40	12,2	0.48	16,0	0.63
FF90103-12S	19,0	0.75	11,2	0.44	15,5	0.61	19,3	0.76
FF90103-16S	25,4	1.00	12,7	0.50	20,6	0.81	25,4	1.00
FF90103-20S	31,7	1.25	14,2	0.56	26,7	1.05	32,0	1.26
FF90103-24S	38,1	1.50	15,7	0.62	32,0	1.26	38,3	1.51

Material: Corrosion-resistant plated steel.

ORS braze type

ORS-BR shoulder internal braze



CAUTION

In applications exceeding +480°F (such as during brazing) order the oil-coated/ non-plated nut by using part number FC1857- Size-186. When plating is heated above +480°F, toxic gases are given off.

FC1229-(Dash size)* (Ref. SAE 520115)
(Formerly Weatherhead Series 4165x)

Dash size	Tube O. D.		A		B		F	
	mm	in	mm	in	mm	in	mm	in
0404S	6,4	0.25	7,4	0.29	6,4	0.25	6,4	0.25
0606S	9,7	0.38	7,4	0.29	6,4	0.25	9,7	0.38
0808S	12,7	0.50	10,7	0.42	9,7	0.38	12,7	0.50
1212S	19,0	0.75	11,2	0.44	9,7	0.38	19,0	0.75
1616S	25,4	1.00	14,2	0.56	12,7	0.50	25,4	1.00
2020S	31,8	1.25	14,2	0.56	12,7	0.50	31,8	1.25
2424S	38,1	1.50	14,2	0.56	12,7	0.50	38,1	1.50

*Eaton braze counterbores are dimensioned for sized or emeryed tubing. If tubing is used as received, contact Eaton for appropriate part number.

ORS-BR shoulder external braze/weld

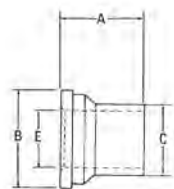

CAUTION

In applications exceeding +480°F (such as during brazing) order the oil-coated/ non-plated nut by using part number FC1857- Size-186. When plating is heated above +480°F, toxic gases are given off.

FC2325-(Dash size)* (Ref. SAE 520172)

Dash size	Tube O. D.		A		B		C		E	
	mm	in	mm	in	mm	in	mm	in	mm	in
0404S	6,4	0.25	22,3	0.88	12,7	0.50	6,4	0.25	4,3	0.17
0606S	9,7	0.38	24,4	0.96	15,7	0.62	9,7	0.38	6,6	0.26
0808S	12,7	0.50	31,8	1.25	18,8	0.74	12,7	0.50	9,1	0.36
1010S	16,0	0.63	34,0	1.34	23,4	0.92	15,7	0.62	11,4	0.45
1212S	19,0	0.75	36,6	1.44	27,7	1.09	19,0	0.75	14,0	0.55
1616S	25,4	1.00	41,4	1.63	34,0	1.34	25,4	1.00	19,8	0.78
2020S	31,8	1.25	41,4	1.63	40,4	1.59	31,8	1.25	26,7	1.05
2424S	38,1	1.50	41,4	1.63	48,5	1.91	38,1	1.50	32,0	1.26

*Eaton braze counterbores are dimensioned for sized or emeryed tubing. If tubing is used as received, contact Eaton for appropriate part number.

Steel adapters

ORS braze type

J

ORS braze type

ORS bulkhead male/braze adapter

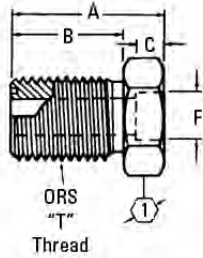

FF1922T(Dash size)* (Ref. SAE 520604)

Dash size	Tube O. D.		Thread T1	A		B		C		D		①
	mm	in		mm	in	mm	in	mm	in	mm	in	
0606S	9,7	0.38	11/16-16	43,7	1.72	34,0	1.34	6,4	0.25	9,7	0.38	1.00
1010S	16,0	0.63	1-14	53,6	2.11	40,6	1.60	9,7	0.38	15,7	0.62	1.31
1212S	19,0	0.75	1 3/16-12	55,4	2.18	41,6	1.64	9,7	0.38	19,0	0.75	1.50
1616S	25,4	1.00	1 7/16-12	61,7	2.43	42,2	1.66	12,7	0.50	25,4	1.00	1.75

ORS/braze adapter

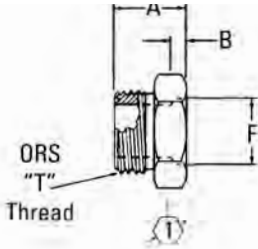

FF1851T(Dash size)* (Ref. SAE 520104)

Dash size	Tube O. D.		Thread T1	A		B		F		①
	mm	in		mm	in	mm	in	mm	in	
0404S	6,4	0.25	9/16-18	19,8	0.78	6,4	0.25	6,4	0.25	0.62
0606S	9,7	0.38	11/16-16	21,0	0.83	6,4	0.25	9,7	0.38	0.75
0608S	9,7	0.38	11/16-16	24,1	0.95	9,7	0.38	12,7	0.50	0.75
0808S	12,7	0.50	13/16-16	25,8	1.01	9,5	0.38	12,8	0.50	0.88
1010S	16,0	0.63	1-14	28,5	1.12	9,7	0.38	15,7	0.62	1.06
1212S	19,0	0.75	1 3/16-12	30,7	1.21	9,7	0.38	19,0	0.75	1.25
1216S	19,0	0.75	1 3/16-12	36,8	1.45	12,7	0.50	25,4	1.00	1.50
1612S	25,4	1.00	1 7/16-12	30,7	1.21	9,7	0.38	19,0	0.75	1.50
1616S	25,4	1.00	1 7/16-12	37,3	1.47	12,7	0.50	25,4	1.00	1.50
1620S	25,4	1.00	1 7/16-12	37,3	1.47	12,7	0.50	31,8	1.25	1.75
2020S	31,8	1.25	1 11/16-12	37,3	1.47	12,7	0.50	31,8	1.25	1.75
2424S	38,1	1.50	2-12	37,3	1.47	12,7	0.50	38,1	1.50	2.12

*Eaton braze counterbores are dimensioned for sized or emeryed tubing. If tubing is used as received, contact Eaton for appropriate part number.

90° ORS/braze port adapter

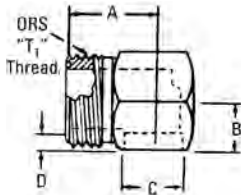

FF1856T(Dash size)* (Ref. SAE 520204)

Dash size	Tube O. D.		Thread T1	A		B		C		D	
	mm	in		mm	in	mm	in	mm	in	mm	in
0606S	9,7	0.38	11/16-16	24,9	0.98	10,4	0.41	9,7	0.38	6,4	0.25
0808S	12,7	0.50	13/16-16	27,9	1.10	15,0	0.59	12,7	0.50	9,7	0.38
1010S	16,0	0.63	1-14	33,3	1.31	16,8	0.66	15,7	0.62	9,7	0.38
1212S	19,0	0.75	1 3/16-12	37,3	1.47	18,3	0.72	19,0	0.75	9,7	0.38
1616S	25,4	1.00	1 7/16-12	41,6	1.64	23,9	0.94	25,4	1.00	13,2	0.52
1820S	25,4	1.00	1 7/16-12	44,7	1.76	28,5	1.12	31,8	1.25	13,5	0.53
2424S	38,1	1.50	2-12	48,8	1.92	31,8	1.25	38,1	1.50	13,2	0.52

ORS braze type

ORS/ORS/braze port adapter

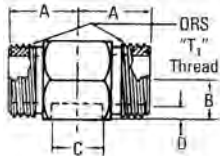

FF1858T(Dash size)* (Ref. SAE 520472)

Dash size	Tube O. D.		Thread T1	A		B		C		D	
	mm	in		mm	in	mm	in	mm	in	mm	in
0606S	9,7	0.38	11/16-16	24,9	0.98	9,9	0.39	9,7	0.38	6,4	0.25
1616S	25,4	1.00	1 7/16-12	41,6	1.64	23,1	0.91	25,4	1.00	13,2	0.52

ORS/braze/ORS port adapter

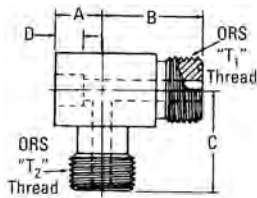

FF2115T(Dash size)* (Ref. SAE 520472)

Dash size	Tube O. D.		Thread T1	Thread T2	A		B		C		D	
	mm	in			mm	in	mm	in	mm	in	mm	in
0606S	9,7	0.38	11/16-16	11/16-16	10,4	0.41	24,9	0.98	24,9	0.98	6,4	0.25

*Eaton braze counterbores are dimensioned for sized or emeryed tubing. If tubing is used as received, contact Eaton for appropriate part number.

ORS-BR nut

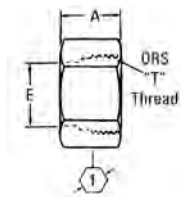

FC2326-(Dash size) (Ref. SAE 520110)
(Formerly Weatherhead Series 4105x)

Dash size	Tube O. D.		Thread T1	A		E		①
	mm	in		mm	in	mm	in	
04S	6,4	0.25	9/16-18	14,7	0.58	10,4	0.41	17,5 0.69
06S	9,7	0.38	11/16-16	17,0	0.67	13,5	0.53	20,6 0.81
08S	12,7	0.50	13/16-16	21,0	0.83	16,5	0.65	23,9 0.94
10S	16,0	0.63	1-14	23,4	0.92	21,0	0.83	28,5 1.12
12S	19,0	0.75	1 3/16-12	25,9	1.02	24,1	0.95	35,1 1.38
16S	25,4	1.00	1 7/16-12	27,9	1.10	29,0	1.14	41,1 1.62
20S	31,8	1.25	1 11/16-12	27,9	1.10	36,1	1.42	47,7 1.88
24S	38,1	1.50	2-12	27,9	1.10	43,9	1.73	57,2 2.25

CAUTION

In applications exceeding +480°F (such as during brazing) order the oil-coated/non-plated nut by using part number FC1857- Size-186. When plating is heated above +480°F, toxic gases are given off.

Steel adapters

ORS/SAE O-Ring boss

J

ORS/SAE O-Ring boss

ORS/SAE O-Ring boss adapter

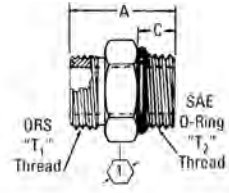

FF1852T(Dash size) (Ref. SAE 520120)
(Formerly Weatherhead Series 4315x)

Dash size	Tube O. D.		Thread T1	Thread T2	A		C		①	
	mm	in			mm	in	mm	in		
0403S	6,4	0.25	9/16-18	3/8-24	27,2	1.07	9,4	0.37	15,7	0.62
0404S	6,4	0.25	9/16-18	7/16-20	28,7	1.13	10,9	0.43	15,7	0.62
0405S	6,4	0.25	9/16-18	1/2-20	28,7	1.13	10,9	0.43	15,7	0.62
0406S	6,4	0.25	9/16-18	9/16-18	30,5	1.20	11,9	0.47	17,5	0.69
0408S	6,4	0.25	9/16-18	3/4-16	33,6	1.32	14,0	0.55	22,4	0.88
0603S	9,7	0.38	11/16-16	3/8-24	32,5	1.28	9,4	0.37	19,1	0.75
0604S	9,7	0.38	11/16-16	7/16-20	34,0	1.34	10,9	0.43	19,1	0.75
0605S	9,7	0.38	11/16-16	1/2-20	31,0	1.22	10,9	0.43	19,1	0.75
0606S	9,7	0.38	11/16-16	9/16-18	32,0	1.26	11,9	0.47	19,1	0.75
0608S	9,7	0.38	11/16-16	3/4-16	35,1	1.38	14,0	0.55	22,4	0.88
0610S	9,7	0.38	11/16-16	7/8-14	38,9	1.53	16,0	0.63	25,4	1.00
0612S	9,7	0.38	11/16-16	1 1/16-12	42,9	1.69	18,5	0.73	31,8	1.25
0616S	9,7	0.38	11/16-16	1 5/16-12	43,9	1.73	18,5	0.73	38,1	1.50
0806S	12,7	0.50	13/16-16	9/16-18	37,6	1.48	11,9	0.47	22,4	0.88
0808S	12,7	0.50	13/16-16	3/4-16	36,6	1.44	14,0	0.55	22,4	0.88
0810S	12,7	0.50	13/16-16	7/8-14	40,4	1.59	16,0	0.63	25,4	1.00
0812S	12,7	0.50	13/16-16	1 1/16-12	44,5	1.75	18,5	0.73	31,8	1.25
0814S	12,7	0.50	13/16-16	1 3/16-12	44,5	1.75	18,5	0.73	35,1	1.38
0816S	12,7	0.50	13/16-16	1 5/16-12	45,5	1.79	18,5	0.73	38,1	1.50
1008S	16,0	0.63	1-14	3/4-16	45,2	1.78	14,0	0.55	26,9	1.06
1010S	16,0	0.63	1-14	7/8-14	43,2	1.70	16,0	0.63	26,9	1.06
1012S	16,0	0.63	1-14	1 1/16-12	47,2	1.86	18,5	0.73	31,8	1.25
1206S	19,0	0.75	1 3/16-12	9/16-18	45,0	1.77	11,9	0.47	31,8	1.25
1208S	19,0	0.75	1 3/16-12	3/4-16	48,5	1.91	14,0	0.55	31,8	1.25
1210S	19,0	0.75	1 3/16-12	7/8-14	50,5	1.99	16,0	0.63	31,8	1.25
1212S	19,0	0.75	1 3/16-12	1 1/16-12	48,8	1.92	18,5	0.73	31,8	1.25
1214S	19,0	0.75	1 3/16-12	1 3/16-12	48,8	1.92	18,5	0.73	35,1	1.38
1216S	19,0	0.75	1 3/16-12	1 5/16-12	49,8	1.96	18,5	0.73	38,1	1.50
1608S	25,4	1.00	1 7/16-12	3/4-16	49,8	1.96	14,0	0.55	38,1	1.50
1610S	25,4	1.00	1 7/16-12	7/8-14	51,8	2.04	16,0	0.63	38,1	1.50
1612S	25,4	1.00	1 7/16-12	1 1/16-12	54,4	2.14	18,5	0.73	38,1	1.50
1614S	25,4	1.00	1 7/16-12	1 3/16-12	50,3	1.98	18,5	0.73	38,1	1.50
1616S	25,4	1.00	1 7/16-12	1 5/16-12	50,3	1.98	18,5	0.73	38,1	1.50
1620S	25,4	1.00	1 7/16-12	1 5/8-12	52,3	2.06	18,5	0.73	47,8	1.88
2016S	31,8	1.25	1 11/16-12	1 5/16-12	57,9	2.28	18,5	0.73	44,5	1.75
2020S	31,8	1.25	1 11/16-12	1 5/8-12	52,3	2.06	18,5	0.73	47,8	1.88
2024S	31,8	1.25	1 11/16-12	1 7/8-12	54,1	2.13	18,5	0.73	53,8	2.12
2420S	38,1	1.50	2-12	1 5/8-12	59,7	2.35	18,5	0.73	53,8	2.12
2424S	38,1	1.50	2-12	1 7/8-12	54,1	2.13	18,5	0.73	53,8	2.12

ORS/SAE O-Ring boss

ORS/SAE O-Ring boss adapter

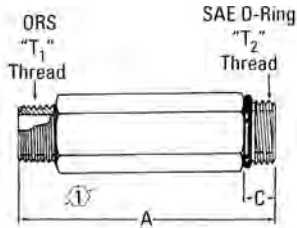

FF2211T(Dash size) (Ref. SAE 520122)

Dash size	Tube O. D.		Thread T1	Thread T2	A		C		①	
	mm	in			mm	in	mm	in	mm	in
0808S	12,7	0.50	13/16-16	3/4-16	68,1	2.68	14,0	0.55	22,3	0.88
1212S	19,0	0.75	1 3/16-12	1 1/16-12	72,9	2.87	18,5	0.73	31,8	1.25
1616S	25,4	1.00	1 7/16-12	1 5/16-12	104,5	4.11	18,5	0.73	38,1	1.50

ORS/SAE O-Ring boss long adapter

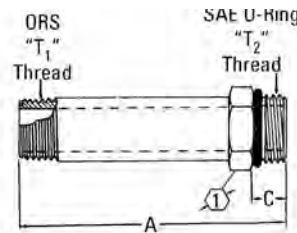

FF1854T(Dash size) (Ref. SAE 520122)
(Formerly Weatherhead Series 4316x)

Dash size	Tube O. D.		Thread T1	Thread T2	A		C		①	
	mm	in			mm	in	mm	in	mm	in
0404S	6,4	0.25	9/16-18	7/16-20	52,6	2.07	10,9	0.43	15,7	0.62
0606S	9,7	0.38	11/16-16	9/16-18	57,6	2.27	11,9	0.47	19,0	0.75
0808S	12,7	0.50	13/16-16	3/4-16	67,8	2.67	14,0	0.55	22,3	0.88
1010S	16,0	0.63	1-14	7/8-14	79,5	3.13	16,0	0.63	26,9	1.06
1212S	19,0	0.75	1 3/16-12	1 1/16-12	95,2	3.75	18,5	0.73	31,8	1.25
1616S	25,4	1.00	1 7/16-12	1 5/16-12	104,9	4.13	18,5	0.73	38,1	1.50
2020S	31,8	1.25	1 11/16-12	1 5/8-12	120,6	4.75	18,5	0.73	47,7	1.88
2424S	38,1	1.50	2-12	1 7/8-12	133,6	5.26	18,5	0.73	53,9	2.12

ORS female swivel/SAE O-Ring boss adapter

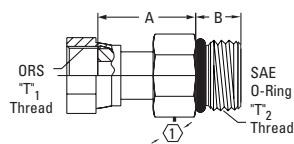

FF2130T(Dash size) (Ref. SAE 520181)

Dash size	Tube O. D.		Thread T1	Thread T2	A		B		①	
	mm	in			mm	in	mm	in	mm	in
0606S	9,7	0.38	11/16-16	9/16-18	28,2	1.11	11,9	0.47	17,5	0.69
0808S	12,7	0.50	13/16-16	3/4-16	35,3	1.39	14,0	0.55	22,3	0.88
1212S	19,0	0.75	1 3/16-12	1 1/16-12	41,1	1.62	18,5	0.73	31,8	1.25
1616S	25,4	1.00	1 7/16-12	1 5/16-12	49,0	1.93	18,5	0.73	38,1	1.50
2020S	31,8	1.25	1 11/16-12	1 5/8-12	47,2	1.86	18,5	0.73	47,7	1.88

Steel adapters

ORS/SAE O-Ring boss

J

ORS/SAE O-Ring boss

90° ORS/SAE O-Ring boss (adj.) adapter

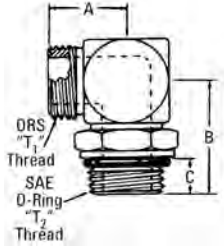

FF1868T(Dash size) (Ref. SAE 520220)
(Formerly Weatherhead Series 4515x)

Dash size	Tube O. D.		Thread T1	Thread T2	A		B		C	
	mm	in			mm	in	mm	in	mm	in
0403S	6,4	0.25	9/16-18	3/8-24	21,6	0.85	30,2	1.19	9,1	0.36
0404S	6,4	0.25	9/16-18	7/16-20	21,6	0.85	32,8	1.29	10,4	0.41
0405S	6,4	0.25	9/16-18	1/2-20	22,4	0.88	34,5	1.36	10,4	0.41
0406S	6,4	0.25	9/16-18	9/16-18	23,4	0.92	36,8	1.45	11,7	0.46
0408S	6,4	0.25	9/16-18	3/4-16	24,6	0.97	40,6	1.60	13,2	0.52
0604S	9,7	0.38	11/16-16	7/16-20	24,9	0.98	34,8	1.37	10,4	0.41
0605S	9,7	0.38	11/16-16	1/2-20	24,9	0.98	34,8	1.37	10,4	0.41
0606S	9,7	0.38	11/16-16	9/16-18	24,9	0.98	36,8	1.45	11,7	0.46
0608S	9,7	0.38	11/16-16	3/4-16	26,4	1.04	40,6	1.60	13,2	0.52
0610S	9,7	0.38	11/16-16	7/8-14	29,2	1.15	50,0	1.97	15,7	0.62
0612S	9,7	0.38	11/16-16	1 1/16-12	31,8	1.25	55,1	2.17	18,0	0.71
0806S	12,7	0.50	13/16-16	9/16-18	28,2	1.11	36,6	1.44	11,7	0.46
0808S	12,7	0.50	13/16-16	3/4-16	27,9	1.10	40,6	1.60	13,2	0.52
0810S	12,7	0.50	13/16-16	7/8-14	30,7	1.21	50,0	1.97	15,7	0.62
0812S	12,7	0.50	13/16-16	1 1/16-12	33,5	1.32	55,1	2.17	18,0	0.71
1008S	16,0	0.63	1-14	3/4-16	33,3	1.31	45,7	1.80	13,2	0.52
1010S	16,0	0.63	1-14	7/8-14	33,3	1.31	50,0	1.97	15,7	0.62
1012S	16,0	0.63	1-14	1 1/16-12	35,8	1.41	55,1	2.17	18,0	0.71
1208S	19,0	0.75	1 3/16-12	3/4-16	37,3	1.47	46,7	1.84	13,2	0.52
1210S	19,0	0.75	1 3/16-12	1 3/16-12	37,3	1.47	51,1	2.01	15,7	0.62
1212S	19,0	0.75	1 3/16-12	1 1/16-12	37,3	1.47	55,1	2.17	18,0	0.71
1214S	19,0	0.75	1 3/16-12	1 3/16-12	37,3	1.47	55,1	2.17	18,0	0.71
1216S	19,0	0.75	1 3/16-12	1 5/16-12	41,1	1.62	59,7	2.35	18,0	0.71
1612S	25,4	1.00	1 7/16-12	1 1/16-12	41,7	1.64	58,9	2.32	18,0	0.71
1614S	25,4	1.00	1 7/16-12	1 3/16-12	41,7	1.64	58,9	2.32	18,0	0.71
1616S	25,4	1.00	1 7/16-12	1 5/16-12	41,7	1.64	59,7	2.35	18,0	0.71
1620S	25,4	1.00	1 7/16-12	1 5/8-12	44,7	1.76	62,2	2.45	18,0	0.71
2012S	31,8	1.25	1 11/16-12	1 1/16-12	44,7	1.76	61,5	2.42	18,0	0.71
2016S	31,8	1.25	1 11/16-12	1 5/16-12	44,7	1.76	61,5	2.42	18,0	0.71
2020S	31,8	1.25	1 11/16-12	1 5/8-12	44,7	1.76	62,2	2.45	18,0	0.71
2420S	38,1	1.50	2-12	1 5/8-12	48,8	1.92	65,8	2.59	18,0	0.71
2424S	38,1	1.50	2-12	1 7/8-12	48,8	1.92	65,8	2.59	18,0	0.71

ORS/SAE O-Ring boss

90° ORS/SAE O-Ring boss (adj.) long adapter

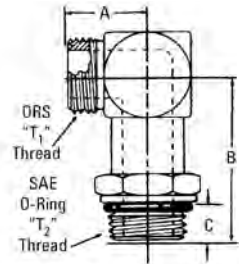

FF2227T(Dash size) (Ref. SAE 521520)
(Formerly Weatherhead Series 4515x-L)

Dash size	Tube O. D.		Thread T1	Thread T2	A		B		C	
	mm	in			mm	in	mm	in	mm	in
0404S	6,4	0.25	9/16-18	7/16-20	21,6	0.85	56,6	2.23	10,9	0.43
0606S	9,7	0.38	11/16-16	9/16-18	24,9	0.98	66,3	2.61	11,9	0.47
0808S	12,7	0.50	13/16-16	3/4-16	27,9	1.10	74,9	2.95	14,0	0.55
1010S	16,0	0.63	1-14	7/8-14	33,3	1.31	89,1	3.51	16,0	0.63
1212S	19,0	0.75	1 3/16-12	1 1/16-12	37,3	1.47	100,8	3.97	18,5	0.73
1616S	25,4	1.00	1 7/16-12	1 5/16-12	41,6	1.64	114,5	4.51	18,5	0.73
2020S	31,8	1.25	1 11/16-12	1 5/8-12	44,7	1.76	126,5	4.98	18,5	0.73

45° ORS/SAE O-Ring boss (adj.) adapter

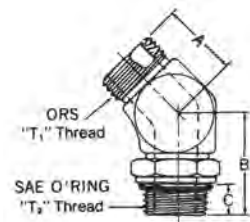

FF2068T(Dash size) (Ref. SAE 520320)
(Formerly Weatherhead Series 4365x)

Dash size	Tube O. D.		Thread T1	Thread T2	A		B		C	
	mm	in			mm	in	mm	in	mm	in
0404S	6,4	0.25	9/16-18	7/16-20	16,0	0.63	30,0	1.18	10,4	0.41
0406S	6,4	0.25	9/16-18	9/16-18	17,3	0.68	33,0	1.30	11,7	0.46
0408S	6,4	0.25	9/16-18	3/4-16	17,0	0.67	36,3	1.43	13,2	0.52
0604S	9,7	0.38	11/16-16	7/16-20	18,8	0.74	31,0	1.22	10,4	0.41
0606S	9,7	0.38	11/16-16	9/16-18	18,8	0.74	33,0	1.30	11,7	0.46
0608S	9,7	0.38	11/16-16	3/4-16	18,8	0.74	36,3	1.43	13,2	0.52
0806S	12,7	0.50	13/16-16	9/16-18	20,3	0.80	32,3	1.27	11,7	0.46
0808S	12,7	0.50	13/16-16	3/4-16	20,3	0.80	36,3	1.43	13,2	0.52
0810S	12,7	0.50	13/16-16	7/8-14	20,8	0.82	44,7	1.76	15,7	0.62
0816S	12,7	0.50	13/16-16	1 5/16-12	25,7	1.01	52,3	2.06	18,0	0.71
1008S	16,0	0.63	1-14	3/4-16	23,4	0.92	40,4	1.59	13,2	0.52
1010S	16,0	0.63	1-14	7/8-14	23,4	0.92	44,7	1.76	15,7	0.62
1012S	16,0	0.63	1-14	1 1/16-12	24,4	0.96	50,0	1.97	18,0	0.71
1210S	19,0	0.75	1 3/16-12	7/8-14	25,9	1.02	46,0	1.81	15,7	0.62
1212S	19,0	0.75	1 3/16-12	1 1/16-12	25,9	1.02	50,0	1.97	18,0	0.71
1216S	19,0	0.75	1 3/16-12	1 5/16-12	29,5	1.16	52,3	2.06	18,0	0.71
1612S	25,4	1.00	1 7/16-12	1 1/16-12	30,0	1.18	51,6	2.03	18,0	0.71
1616S	25,4	1.00	1 7/16-12	1 5/16-12	30,0	1.18	52,3	2.06	18,0	0.71
1620S	25,4	1.00	1 7/16-12	1 5/8-12	32,0	1.26	53,6	2.11	18,0	0.71
2020S	31,8	1.25	1 11/16-12	1 5/8-12	32,0	1.26	53,6	2.11	18,0	0.71
2424S	38,1	1.50	2-12	1 7/8-12	36,8	1.45	53,6	2.11	18,0	0.71

Steel adapters

ORS/SAE O-Ring boss

J

ORS/SAE O-Ring boss

ORS/ORS/SAE O-Ring boss (adj.) adapter

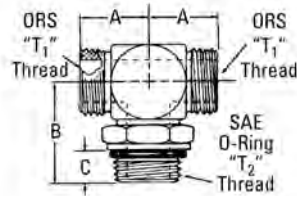

FF1861T(Dash size) (Ref. SAE 520429)
(Formerly Weatherhead Series 4715x)

Dash size	Tube O. D.		Thread T1	Thread T2	A		B		C	
	mm	in			mm	in	mm	in	mm	in
0404S	6,4	0.25	9/16-18	7/16-20	21,6	0.85	32,8	1.29	10,9	0.43
0606S	9,7	0.38	11/16-16	9/16-18	24,9	0.98	36,8	1.45	11,9	0.47
0608S	9,7	0.38	11/16-16	3/4-16	26,4	1.04	40,6	1.60	14,0	0.55
0806S	12,7	0.50	13/16-16	9/16-16	27,9	1.10	50,0	1.97	14,0	0.55
0808S	16,0	0.63	1-14	3/4-16	36,6	1.44	50,0	1.97	16,0	0.63
1010S	19,0	0.75	1 3/16-12	7/8-14	37,3	1.47	55,2	2.17	16,0	0.63
1210S	19,0	0.75	1 3/16-12	7/8-14	41,1	1.62	59,7	2.35	18,5	0.73
1212S	19,0	0.75	1 3/16-12	1 5/16-12	41,6	1.64	59,7	2.35	18,5	0.73
1216S	25,4	1.00	1 7/16-12	1 5/16-12	41,6	1.64	59,7	2.35	18,5	0.73
1616S	25,4	1.00	1 7/16-12	1 5/16-12	41,6	1.64	59,7	2.35	18,0	0.71
2020S	31,8	1.25	1 11/16-12	1 5/8-12	44,7	1.76	62,2	2.45	18,5	0.73

ORS/ORS/SAE O-Ring boss (adj.) adapter

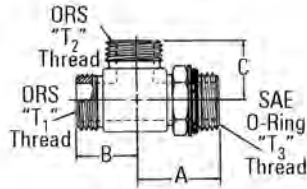

FF1865T(Dash size) (Ref. SAE 520428)
(Formerly Weatherhead Series 4716x)

Dash size	Tube O. D.		Thread T1	Thread T2	Thread T3	A		B		C	
	mm	in				mm	in	mm	in	mm	in
0404S	6,4	0.25	9/16-18	9/16-18	7/16-20	32,8	1.29	21,6	0.85	21,6	0.85
0406S	6,4	0.25	9/16-18	9/16-18	9/16-18	36,8	1.45	23,4	0.92	23,4	0.92
0604S	9,7	0.38	11/16-16	11/16-16	7/16-20	34,8	1.37	29,7	1.17	24,9	0.98
0606S	9,7	0.38	11/16-16	11/16-16	9/16-18	36,8	1.45	24,9	0.98	24,9	0.98
0806S	12,7	0.50	13/16-16	13/16-16	9/16-18	36,6	1.44	27,9	1.10	27,9	1.10
0808S	12,7	0.50	13/16-16	13/16-16	3/4-16	40,6	1.60	27,9	1.10	27,9	1.10
0812S	12,7	0.50	13/16-16	13/16-16	1 1/16-12	55,1	2.17	33,5	1.32	33,5	1.32
1010S	16,0	0.63	1-14	1-14	7/8-14	50,0	1.97	33,3	1.31	33,3	1.31
1012S	16,0	0.63	1-14	1-14	1 1/16-12	55,1	2.17	35,8	1.41	35,8	1.41
1212S	19,0	0.75	1 3/16-12	1 3/16-12	1 1/16-12	55,1	2.17	37,3	1.47	37,3	1.47
1220S	19,0	0.75	1 3/16-12	1 3/16-12	1 5/8-12	62,2	2.45	44,2	1.74	44,2	1.74
1616S	25,4	1.00	1 7/16-12	1 7/16-12	1 5/16-12	59,7	2.35	41,7	1.64	41,7	1.64
2020S	31,8	1.25	1 11/16-12	1 11/16-12	1 5/8-12	62,2	2.45	44,7	1.76	44,7	1.76
2424S	38,1	1.50	2-12	2-12	1 7/8-12	65,8	2.59	48,8	1.92	48,8	1.92

ORS/NPTF

ORS/male NPTF adapter

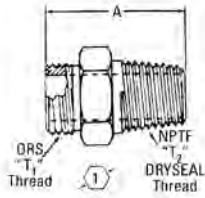

FF2031T(Dash size) (Ref. SAE 520102)
(Formerly Weatherhead Series 4205x)

Dash size	Tube O. D.		Thread T1	Thread T2	A		①	
	mm	in			mm	in	mm	in
0402S	6,4	0.25	9/16-18	1/8-27	26,2	1.03	15,7	0.62
0404S	6,4	0.25	9/16-18	1/4-18	31,5	1.24	15,7	0.62
0406S	6,4	0.25	9/16-18	3/8-18	31,5	1.24	19,1	0.75
0408S	6,4	0.25	9/16-18	1/2-14	37,8	1.49	22,4	0.88
0602S	9,7	0.38	11/16-16	1/8-27	28,4	1.12	19,1	0.75
0604S	9,7	0.38	11/16-16	1/4-18	33,0	1.30	19,1	0.75
0606S	9,7	0.38	11/16-16	3/8-18	33,0	1.30	19,1	0.75
0608S	9,7	0.38	11/16-16	1/2-14	39,4	1.55	22,4	0.88
0804S	12,7	0.50	13/16-16	1/4-18	34,5	1.36	22,4	0.88
0806S	12,7	0.50	13/16-16	3/8-18	34,5	1.36	22,4	0.88
0808S	12,7	0.50	13/16-16	1/2-14	40,9	1.61	22,4	0.88
0812S	12,7	0.50	13/16-16	3/4-14	42,7	1.68	26,9	1.06
1008S	16,0	0.63	1-14	1/2-14	43,7	1.72	26,9	1.06
1012S	16,0	0.63	1-14	3/4-14	45,2	1.78	26,9	1.06
1208S	19,0	0.75	1 3/16-12	1/2-14	46,7	1.84	31,8	1.25
1212S	19,0	0.75	1 3/16-12	3/4-14	46,7	1.84	31,8	1.25
1216S	19,0	0.75	1 3/16-12	1-11 1/2	51,6	2.03	35,1	1.38
1612S	25,4	1.00	1 7/16-12	3/4-14	47,2	1.86	38,1	1.50
1616S	25,4	1.00	1 7/16-12	1-11 1/2	52,1	2.05	38,1	1.50
1620S	25,4	1.00	1 7/16-12	1 1/4-11 1/2	54,9	2.16	42,9	1.69
2016S	31,8	1.25	1 11/16-12	1-11 1/2	54,1	2.13	44,5	1.75
2020S	31,8	1.25	1 11/16-12	1 1/4-11 1/2	54,9	2.16	44,5	1.75
2424S	38,1	1.50	2-12	1 1/2-11 1/2	57,4	2.26	53,8	2.12

45° ORS/male NPTF adapter

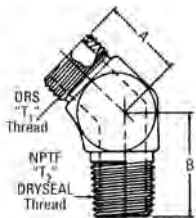

FF2093T(Dash size) (Ref. SAE 520302)
(Formerly Weatherhead Series 4355x)

Dash size	Tube O. D.		Thread T1	Thread T2	A		B	
	mm	in			mm	in	mm	in
0402S	6,4	0.25	9/16-18	1/8-27	16,0	0.63	17,3	0.68
0404S	6,4	0.25	9/16-18	1/4-18	17,3	0.68	23,6	0.93
0604S	9,7	0.38	11/16-16	1/4-18	18,8	0.74	23,6	0.93
0606S	9,7	0.38	11/16-16	3/8-18	18,8	0.74	26,4	1.04
0806S	12,7	0.50	13/16-16	3/8-18	20,3	0.80	26,4	1.04
0808S	12,7	0.50	13/16-16	1/2-14	20,8	0.82	30,5	1.20
1008S	16,0	0.63	1-14	1/2-14	23,4	0.92	30,5	1.20
1212S	19,0	0.75	1 3/16-12	3/4-14	25,9	1.02	31,2	1.23
1616S	25,4	1.00	1 7/16-12	1-11 1/2	30,0	1.18	38,3	1.51
2020S	31,8	1.25	1 11/16-12	1 1/4-11 1/2	32,0	1.26	42,9	1.69
2424S	38,1	1.50	2-12	1 1/2-11 1/2	36,8	1.45	45,7	1.80

Steel adapters

ORS/NPTF

J

ORS/NPTF

90° ORS/male NPTF adapter

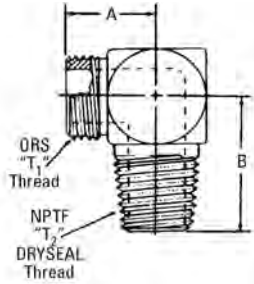

FF2032T(Dash size) (Ref. SAE 520202)
(Formerly Weatherhead Series 4405x)

Dash size	Tube O.D.		Thread T1	Thread T2	A		B	
	mm	in			mm	in	mm	in
0402S	6,4	0.25	9/16-18	1/8-27	21,6	0.85	21,3	0.84
0404S	6,4	0.25	9/16-18	1/4-18	23,4	0.92	29,2	1.15
0406S	6,4	0.25	9/16-18	3/8-18	24,4	0.96	31,8	1.25
0602S	9,7	0.38	11/16-16	1/8-27	24,9	0.98	24,4	0.96
0604S	9,7	0.38	11/16-16	1/4-18	24,9	0.98	29,2	1.15
0606S	9,7	0.38	11/16-16	3/8-18	26,4	1.04	31,8	1.25
0608S	9,7	0.38	11/16-16	1/2-14	29,2	1.15	38,9	1.53
0802S	12,7	0.50	13/16-16	1/8-27	27,9	1.10	22,1	0.87
0806S	12,7	0.50	13/16-16	3/8-18	27,9	1.10	31,8	1.25
0808S	12,7	0.50	13/16-16	1/2-14	30,7	1.21	38,9	1.53
0812S	12,7	0.50	13/16-16	3/4-14	33,5	1.32	41,9	1.65
1008S	16,0	0.63	1-14	1/2-14	33,3	1.31	38,9	1.53
1012S	16,0	0.63	1-14	3/4-14	35,8	1.41	41,9	1.65
1208S	19,0	0.75	1 3/16-12	1/2-14	37,3	1.47	41,9	1.65
1212S	19,0	0.75	1 3/16-12	3/4-14	37,3	1.47	41,9	1.65
1216S	19,0	0.75	1 3/16-12	1-11 1/2	41,1	1.62	51,6	2.03
1612S	25,4	1.00	1 7/16-12	3/4-14	41,7	1.64	46,7	1.84
1616S	25,4	1.00	1 7/16-12	1-11 1/2	41,7	1.64	51,6	2.03
2016S	31,8	1.25	1 11/16-12	1-11 1/2	44,7	1.76	60,5	2.38
2020S	31,8	1.25	1 11/16-12	1 1/4-11 1/2	44,7	1.76	61,2	2.41
2424S	38,1	1.50	2-12	1 1/2-11 1/2	48,8	1.92	68,6	2.70

ORS/ORS/male NPTF adapter

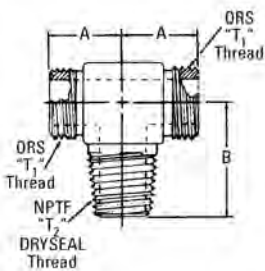

FF2001T(Dash size) (Ref. SAE 520425)

Dash size	Tube O. D.		Thread T1	Thread T2	A		B	
	mm	in			mm	in	mm	in
0404S	6,4	0.25	9/16-18	1/4-18	23,4	0.92	27,4	1.08
0604S	9,7	0.38	11/16-16	1/4-18	24,9	0.98	27,4	1.08
0606S	9,7	0.38	11/16-16	3/8-18	26,4	1.04	30,7	1.21
0806S	12,7	0.50	13/16-16	3/8-18	27,9	1.10	30,7	1.21
0808S	12,7	0.50	13/16-16	1/2-14	30,7	1.21	38,9	1.53
1212S	19,0	0.75	1 3/16-12	3/4-14	37,3	1.47	41,9	1.65
1616S	25,4	1.00	1 7/16-12	1-11 1/2	41,6	1.64	51,6	2.03

ORS to SAE 37° flare

ORS female swivel/SAE 37° male flare

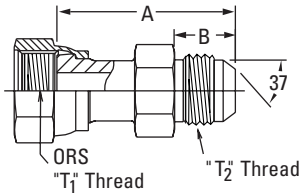

FF2209T(Dash size)
(Formerly Weatherhead Series 4213x)

Dash size	Tube O. D.		Thread T1	Thread T2	A		B	
	mm	in			mm	in	mm	in
0404S	6,4	0.25	9/16-18	7/16-20	38,1	1.50	14,0	1.55
0412S	6,4	0.25	9/16-18	1 1/16-12	50,5	1.99	21,8	0.86
0606S	9,7	0.38	11/16-16	9/16-18	41,4	1.62	14,2	0.56
0612S	9,7	0.38	11/16-16	1 1/16-12	52,6	2.07	21,8	0.86
0808S	12,7	0.50	13/16-16	3/4-16	51,6	2.03	16,8	0.66
0812S	12,7	0.50	13/16-16	1 1/16-12	57,2	2.25	21,8	0.86
1010S	16,0	0.63	1-14	7/8-14	53,6	2.11	19,3	0.76
1212S	19,0	0.75	1 3/16-12	1 1/16-12	62,0	2.44	21,8	0.86
1616S	25,4	1.00	1 7/16-12	1 5/16-12	71,6	2.82	23,1	0.91
2016S	31,8	1.25	1 11/16-12	1 5/16-12	73,1	2.88	23,1	0.91
2020S	31,8	1.35	1 11/16-12	1 5/8-12	76,7	3.02	24,3	0.96

Male ORS/SAE 37° male flare

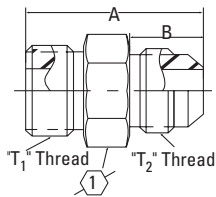

FF2313T(Dash size)

Dash size	Tube O. D.		Thread T1	Thread T2	A		B		①
	mm	in			mm	in	mm	in	
0808S	12,7	0.50	13/16-16	3/4-16	39,1	1.54	16,8	0.66	22,3 0.88

Everything you need to know about more than 200,000 products

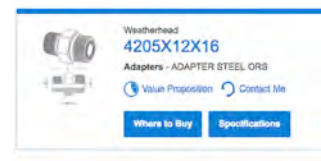
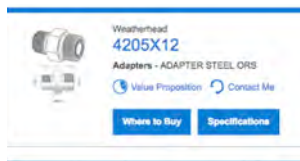
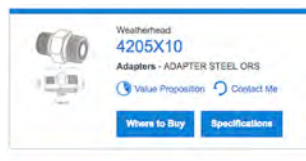

eatonpowersource.com

Steel adapters

ORS/ORS

J

ORS/ORS

ORS/ORS adapter

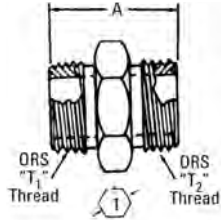

FF2000T(Dash size) (Ref. SAE 520101)
(Formerly Weatherhead Series 4305x)

Dash size	Tube O. D.		Thread T1	Thread T2	A		①	
	mm	in			mm	in	mm	in
0404S	6,4	0.25	9/16-18	9/16-18	27,4	1.08	15,7	0.62
0604S	9,7	0.38	11/16-16	9/16-18	29,7	1.17	19,0	0.75
0606S	9,7	0.38	11/16-16	11/16-16	31,0	1.22	19,0	0.75
0806S	12,7	0.50	13/16-16	11/16-16	33,8	1.33	22,3	0.88
0808S	12,7	0.50	13/16-16	13/16-16	35,3	1.39	22,3	0.88
1008S	16,0	0.63	1-14	13/16-16	39,9	1.57	26,9	1.06
1010S	16,0	0.63	1-14	1-14	42,7	1.68	26,9	1.06
1208S	19,0	0.75	1 3/16-12	13/16-16	42,9	1.69	31,8	1.25
1210S	19,0	0.75	1 3/16-12	1-14	45,7	1.80	31,8	1.25
1212S	19,0	0.75	1 3/16-12	1 3/16-12	47,2	1.86	31,8	1.25
1612S	25,4	1.00	1 7/16-12	1 3/16-12	48,8	1.92	38,1	1.50
1616S	25,4	1.00	1 7/16-12	1 7/16-12	49,3	1.94	38,1	1.50
2020S	31,8	1.25	1 11/16-12	1 11/16-12	51,3	2.02	44,4	1.75
2424S	38,1	1.50	2-12	2-12	53,1	2.09	53,9	2.12

ORS/ORS reducer adapter

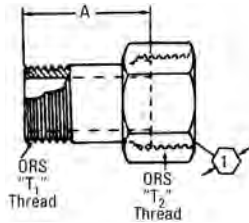

FF2281T(Dash size) (Ref. SAE 520123)

Dash size	Tube O. D.		Thread T1	Thread T2	A		①	
	mm	in			mm	in	mm	in
0406S	9,7	0.38	9/16-18	11/16-16	19,5	0.77	20,6	0.81
0408S†	12,7	0.50	9/16-18	13/16-16	21,8	0.86	23,9	0.94
0410S†	16,0	0.63	9/16-18	1-14	22,9	0.90	28,5	1.12
0412S†	19,0	0.75	9/16-18	1 3/16-12	24,9	0.98	35,1	1.38
0608S	12,7	0.50	11/16-16	13/16-16	22,3	0.88	23,9	0.94
0610S†	16,0	0.63	11/16-16	1-14	24,1	0.95	28,5	1.12
0612S†	19,0	0.75	11/16-16	1 3/16-12	26,2	1.03	35,1	1.38
0810S†	16,0	0.63	13/16-16	1-14	25,9	1.02	28,5	1.12
0812S†	19,0	0.75	13/16-16	1 3/16-12	27,9	1.10	35,1	1.38
0816S†	25,4	1.00	13/16-16	1 7/16-12	29,2	1.15	41,1	1.62
1012S	16,0	0.63	1 3/16-12	1-14	29,5	1.16	34,9	1.38
1216S	25,4	1.00	1 3/16-12	1 7/16-12	34,0	1.34	41,1	1.62
1220S†	31,8	1.25	1 3/16-12	1 11/16-12	33,5	1.32	47,7	1.88
1224S†	38,1	1.50	1 3/16-12	2-12	33,6	1.32	57,2	2.25
1620S	31,8	1.25	1 7/16-12	1 11/16-12	37,3	2.69	47,7	1.88
1624S†	38,1	1.50	1 7/16-12	2-12	34,0	1.34	57,2	2.25

† Available without nut. Order by part number FF2151T (Size).

ORS/ORS

ORS/ORS bulkhead adapter

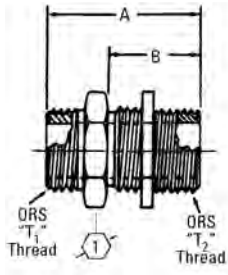

FF1994T(Dash size) (Ref. SAE 520601)
(Formerly Weatherhead Series 4325x)

Dash size	Tube O. D.		Thread T1	Thread T2	A		B		①
	mm	in			mm	in	mm	in	
0404S	6,4	0.25	9/16-18	9/16-18	48,3	1.90	31,5	1.24	20,6 0.81
0606S	9,7	0.38	11/16-16	11/16-16	53,1	2.09	34,0	1.34	25,4 1.00
0608S	9,7	0.38	11/16-16	13/16-16	56,9	2.24	36,6	1.44	28,4 1.12
0808S	12,7	0.50	13/16-16	13/16-16	58,4	2.30	36,6	1.44	28,4 1.12
1010S	16,0	0.63	1-14	1-14	66,5	2.62	40,6	1.60	33,3 1.31
1212S	19,0	0.75	1 3/16-12	1 3/16-12	69,1	2.72	41,7	1.64	38,1 1.50
1616S	25,4	1.00	1 7/16-12	1 7/16-12	70,1	2.76	42,2	1.66	44,5 1.75
2016S	31,8	1.25	1 11/16-12	1 7/16-12	70,1	2.76	42,2	1.66	44,5 1.75
2020S	31,8	1.25	1 11/16-12	1 11/16-12	70,1	2.76	42,2	1.66	50,8 2.00
2424S	38,1	1.50	2-12	2-12	70,1	2.76	42,2	1.66	60,5 2.38

Note: Available without nut. Order by Part no. FF1994H4-(dash size).

45° ORS/ORS female adapter

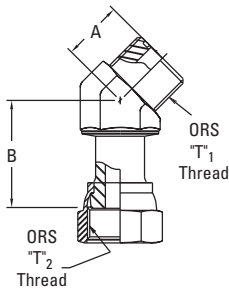

FF2133T(Dash size)

Dash size	Tube O. D.		Thread T1	Thread T2	A		B	
	mm	in			mm	in	mm	in
0606S	9,7	0.38	11/16-16	11/16-16	18,8	0.74	26,9	1.06
0808S	12,7	0.50	13/16-16	13/16-16	20,3	0.80	35,6	1.40
1010S	16,0	0.63	1-14	1-14	23,4	0.92	38,6	1.52
1212S	19,0	0.75	1 3/16-12	1 3/16-12	25,9	1.02	42,4	1.67
1616S	25,4	1.00	1 7/6-12	1 7/6-12	30,0	1.18	42,9	1.69

45° ORS/ORS bulkhead adapter

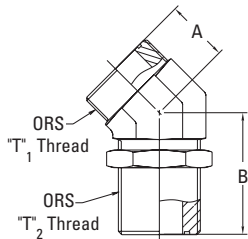

FF2144T(Dash size) (Ref. SAE 520801)

Dash size	Tube O. D.		Thread T1	Thread T2	A		B	
	mm	in			mm	in	mm	in
0404S	6,4	0.25	9/16-18	9/16-18	16,0	0.63	43,9	1.73
0606S	9,7	0.38	11/16-16	11/16-16	18,8	0.74	48,5	1.91
0808S	12,7	0.50	13/16-16	13/16-16	20,3	0.80	51,1	2.01
1212S	19,0	0.75	1 3/16-12	1 3/16-12	25,9	1.02	60,7	2.39
1616S	25,4	1.00	1 7/16-12	1 7/16-12	30,0	1.18	65,3	2.57

Note: Available without nut. Order by Part no. FF2144H4-(dash size).

90° ORS/ORS female adapter

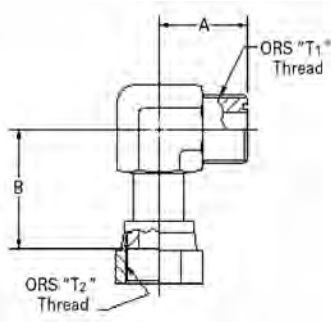

FF2098T(Dash size) (Ref. SAE 520221)
(Formerly Weatherhead Series 4506x)

Dash size	Tube O. D.		Thread T1	Thread T2	A		B	
	mm	in			mm	in	mm	in
0404S	6,4	0.25	9/16-18	9/16-18	21,6	0.85	26,4	1.04
0606S	9,7	0.38	11/16-16	11/16-16	24,9	0.98	29,2	1.15
0808S	12,7	0.50	13/16-16	13/16-16	27,9	1.10	37,8	1.49
1010S	16,0	0.63	1-14	1-14	33,3	1.31	41,1	1.62
1212S	19,0	0.75	1 3/16-12	1 3/16-12	37,3	1.47	46,2	1.82
1616S	25,4	1.00	1 7/16-12	1 7/16-12	41,7	1.64	53,3	2.10
2020S	31,8	1.25	1 11/16-12	1 11/16-12	44,7	1.76	58,2	2.29
2424S	38,1	1.50	2-12	2-12	48,8	1.92	61,2	2.41

Steel adapters

ORS/ORS

J

ORS/ORS

90° ORS/ORS adapter

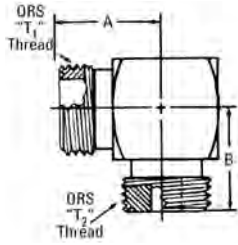

FF2035T(Dash size) (Ref. SAE 520201)
(Formerly Weatherhead Series 4505x)

Dash size	Tube O. D.		Thread T1	Thread T2	A		B	
	mm	in			mm	in	mm	in
0404S	6,4	0.25	9/16-18	9/16-18	21,6	0.85	21,6	0.85
0604S	9,7	0.38	11/16-16	9/16-18	24,9	0.98	23,4	0.92
0606S	9,7	0.38	11/16-16	11/16-16	24,9	0.98	24,9	0.98
0808S	12,7	0.50	13/16-16	13/16-16	27,9	1.10	27,9	1.10
1010S	16,0	0.63	1-14	1-14	33,3	1.31	33,3	1.31
1212S	19,0	0.75	1 3/16-12	1 3/16-12	37,3	1.47	37,3	1.47
1616S	25,4	1.00	1 7/16-12	1 7/16-12	41,6	1.64	41,6	1.64
2020S	31,8	1.25	1 11/16-12	1 11/16-12	44,7	1.76	44,7	1.76

90° ORS/ORS bulkhead adapter

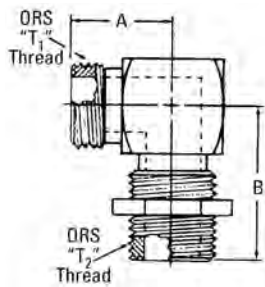

FF2030T(Dash size) (Ref. SAE 520701)
(Formerly Weatherhead Series 4525x)

Dash size	Tube O. D.		Thread T1	Thread T2	A		B		E	
	mm	in			mm	in	mm	in		
0404S	6,4	0.25	9/16-18	9/16-18	22,6	0.89	47,0	1.85	4,3	0.17
0606S	9,7	0.38	11/16-16	11/16-16	25,9	1.02	52,1	2.05	6,6	0.26
0806S	12,7	0.50	13/16-16	11/16-16	29,0	1.14	53,8	2.12	6,6	0.26
0808S	12,7	0.50	13/16-16	13/16-16	29,0	1.14	55,4	2.18	9,7	0.38
1010S	16,0	0.63	1-14	1-14	34,5	1.36	63,0	2.48	12,2	0.48
1212S	19,0	0.75	1 3/16-12	1 3/16-12	38,6	1.52	67,3	2.65	15,5	0.61
1616S	25,4	1.00	1 7/16-12	1 7/16-12	42,4	1.67	71,1	2.80	20,6	0.81
2020S	31,8	1.25	1 11/16-12	1 11/16-12	45,5	1.79	75,4	2.97	26,2	1.03

Note: Available without nut. Order by Part no. FF2030H4-(dash size).

ORS/ORS/ORS

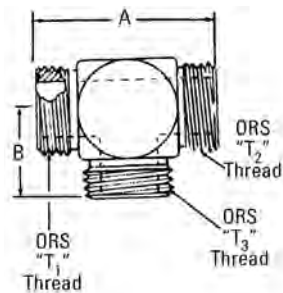

FF1898T(Dash size) (Ref. SAE 520401)
(Formerly Weatherhead Series 4705x)

Dash size	Tube O. D.		Thread T1	Thread T2	Thread T3	A		B	
	mm	in				mm	in	mm	in
0404S	6,4	0.25	9/16-18	9/16-18	9/16-18	43,2	1.70	21,6	0.85
0606S	9,7	0.38	11/16-16	11/16-16	11/16-16	49,8	1.96	24,9	0.98
0608S	9,7	0.38	11/16-16	11/16-16	13/16-16	52,8	2.08	27,9	1.10
0808S	12,7	0.50	13/16-16	13/16-16	13/16-16	55,9	2.20	27,9	1.10
1010S	16,0	0.63	1-14	1-14	1-14	66,5	2.62	33,3	1.31
1212S	19,0	0.75	1 3/16-12	1 3/16-12	1 3/16-12	74,7	2.94	37,3	1.47
1216S	19,0	0.75	1 3/16-12	1 3/16-12	1 7/16-12	82,3	3.24	44,7	1.76
1616S	25,4	1.00	1 7/16-12	1 7/16-12	1 7/16-12	83,3	3.28	41,6	1.64
2016S	31,8	1.25	1 11/16-12	1 11/16-12	1 7/16-12	89,4	3.52	44,7	1.76
2020S	31,8	1.25	1 11/16-12	1 11/16-12	1 11/16-12	89,4	3.52	44,7	1.76
2424S	38,1	1.50	2-12	2-12	2-12	97,5	3.84	48,8	1.92

ORS/ORS

ORS - bulkhead run tee

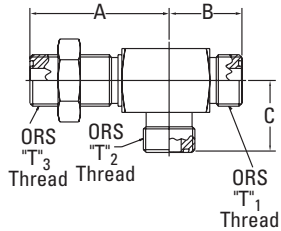

FF2174T(Dash size) (Ref. SAE 520958)
(Formerly Weatherhead Series 4726x)

Dash size	Tube O. D.		Thread T1	Thread T2	Thread T3	A		B		C	
	mm	in				mm	in	mm	in	mm	in
0404S	6,4	0.25	9/16-18	9/16-18	9/16-18	47,0	1.85	22,6	0.89	22,6	0.89
0606S	9,7	0.38	11/16-16	11/16-16	11/16-16	52,0	2.05	25,9	1.02	25,7	1.01
0808S	12,7	0.50	13/16-16	13/16-16	13/16-16	55,4	2.18	29,0	1.14	28,7	1.13
1212S	19,0	0.75	1 3/16-12	1 3/16-12	1 3/16-12	54,9	2.16	40,6	1.60	40,6	1.60
1616S	25,4	1.00	1 7/16-12	1 7/16-12	1 7/16-12	71,1	2.80	42,4	1.67	42,4	1.67
2020S	31,8	1.25	1 11/16-12	1 11/16-12	1 11/16-12	71,1	2.80	48,8	1.92	48,8	1.92

ORS/ORS/ORS female adapter

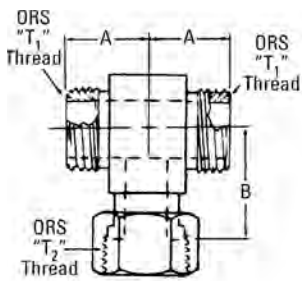

FF1857T(Dash size) (Ref. SAE 520433)
(Formerly Weatherhead Series 4707x)

Dash size	Tube O. D.		Thread T1	Thread T2	A		B	
	mm	in			mm	in	mm	in
0404S	6,4	0.25	9/16-18	9/16-18	21,6	0.85	26,4	1.04
0606S	9,7	0.38	11/16-16	11/16-16	24,9	0.98	29,2	1.15
0808S	12,7	0.50	13/16-16	13/16-16	27,9	1.10	37,8	1.49
1010S	16,0	0.63	1-14	1-14	33,3	1.31	41,1	1.62
1212S	19,0	0.75	1 3/16-12	1 3/16-12	37,3	1.47	46,2	1.82
1616S	25,4	1.00	1 7/16-12	1 7/16-12	41,6	1.64	53,3	2.10
2020S	31,8	1.25	1 11/16-12	1 11/16-12	44,7	1.76	58,2	2.29

ORS/ORS female/ORS adapter

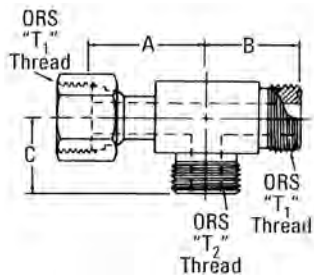

FF2114T(Dash size) (Ref. SAE 520432)
(Formerly Weatherhead Series 4706x)

Dash size	Tube O. D.		Thread T1	Thread T2	A		B		C	
	mm	in			mm	in	mm	in	mm	in
0404S	6,4	0.25	9/16-18	9/16-18	26,4	1.04	21,6	0.85	21,6	0.85
0606S	9,7	0.38	11/16-16	11/16-16	29,2	1.15	24,9	0.98	24,9	0.98
0808S	12,7	0.50	13/16-16	13/16-16	37,8	1.49	27,9	1.10	27,9	1.10
1010S	16,0	0.63	1-14	1-14	41,1	1.62	33,3	1.31	33,3	1.31
1212S	19,0	0.75	1 3/16-12	1 3/16-12	46,2	1.82	37,3	1.47	37,3	1.47
1616S	25,4	1.00	1 7/16-12	1 7/16-12	53,3	2.10	41,7	1.64	41,7	1.64
2020S	31,8	1.25	1 11/16-12	1 11/16-12	58,2	2.29	44,7	1.76	44,7	1.76
2424S	38,1	1.50	2-12	2-12	61,2	2.41	48,8	1.92	48,8	1.92

ORS/ORS/ORS bulkhead adapter

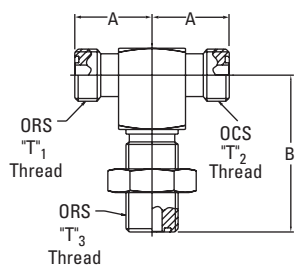

FF2033T(Dash size) (Ref. SAE 520959)

Dash size	Tube O. D.		Thread T1	Thread T2	Thread T3	A		B	
	mm	in				mm	in	mm	in
0606S	9,7	0.38	11/16-16	11/16-16	11/16-16	25,7	1.01	52,0	2.05
0808S	12,7	0.50	13/16-16	13/16-16	13/16-16	28,7	1.13	55,4	2.18
1212S	19,0	0.75	1 3/16-12	1 3/16-12	1 3/16-12	40,6	1.60	67,3	2.65
1616S	25,4	1.00	1 7/16-12	1 7/16-12	1 7/16-12	42,4	1.67	71,1	2.80

Steel adapters

ORS accessories

J

ORS accessories

ORS Bulkhead nut

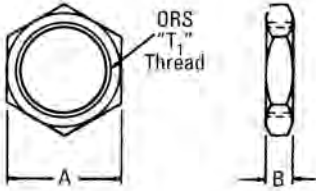

FF9768-(Dash size) (Ref. SAE 520118)
(Formerly Weatherhead Series 4924x)

Dash size	Tube O. D.		Thread T1	A		B	
	mm	in		mm	in	mm	in
04S	6,4	0.25	9/16-18	20,6	0.81	6,8	0.27
06S	9,7	0.38	11/16-16	25,4	1.00	7,9	0.31
08S	12,7	0.50	13/16-16	28,5	1.12	8,9	0.35
10S	16,0	0.63	1-14	33,3	1.31	10,4	0.41
12S	19,0	0.75	1 3/16-12	38,1	1.50	10,4	0.41
16S	25,4	1.00	1 7/16-12	44,4	1.75	10,4	0.41
20S	31,8	1.25	1 11/16-12	50,8	2.00	10,4	0.41
24S	38,1	1.50	2-12	60,4	2.38	10,4	0.41

ORS plug

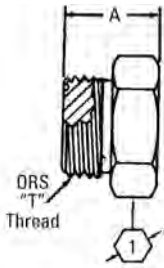

FF9767T-(Dash size) (Ref. SAE 520109)
(Formerly Weatherhead Series 4229x)

Dash size	Tube O. D.		Thread T1	A		1	
	mm	in		mm	in	mm	in
04-S	6,4	0.25	9/16-18	16,8	0.66	15,7	0.62
06-S	9,7	0.38	11/16-16	19,1	0.75	19,1	0.75
08-S	12,7	0.50	13/16-16	22,1	0.87	22,4	0.88
10-S	16,0	0.63	1-14	25,9	1.02	26,9	1.06
12-S	19,0	0.75	1 3/16-12	27,4	1.08	31,8	1.25
16-S	25,4	1.00	1 7/16-12	27,9	1.10	38,1	1.50
20-S	31,8	1.25	1 11/16-12	27,9	1.10	44,5	1.75
24-S	38,1	1.50	2-12	27,9	1.10	53,8	2.12

ORS cap assembly

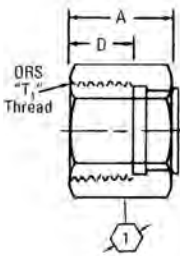

FF9863-(Dash size) (Ref. SAE 520112)
(Formerly Weatherhead Series 4129x)

Dash size	Tube O. D.		Thread T1	A		D		1	
	mm	in		mm	in	mm	in	mm	in
04S	6,4	0.25	9/16-18	16,8	0.66	8,1	0.32	17,5	0.69
06S	9,7	0.38	11/16-16	19,1	0.75	9,7	0.38	20,6	0.81
08S	12,7	0.50	13/16-16	22,9	0.90	10,9	0.43	23,9	0.94
10S	16,0	0.63	1-14	25,4	1.00	13,5	0.53	28,4	1.12
12S	19,0	0.75	1 3/16-12	27,9	1.10	14,5	0.57	35,1	1.38
16S	25,4	1.00	1 7/16-12	29,7	1.17	14,7	0.58	41,1	1.62
20S	31,8	1.25	1 11/16-12	29,7	1.17	14,7	0.58	47,8	1.88
24S	38,1	1.50	2-12	29,7	1.17	14,7	0.58	57,2	2.25

ORS accessories

ORS cap (use with FC2326 nut)

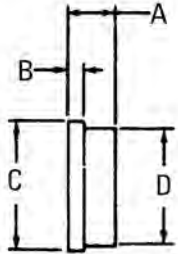

FF9766-(Dash size)

Dash size	Tube O. D.		A		B		C		D	
	mm	in	mm	in	mm	in	mm	in	mm	in
04S	6,4	0.25	8,6	0.34	4,1	0.16	12,7	0.50	10,2	0.40
06S	9,7	0.38	9,4	0.37	4,6	0.18	15,7	0.62	13,2	0.52
08S	12,7	0.50	11,9	0.47	5,1	0.20	18,8	0.74	16,2	0.64
10S	16,0	0.63	11,9	0.47	6,1	0.24	23,4	0.92	20,8	0.82
12S	19,0	0.75	13,5	0.53	6,6	0.26	27,7	1.09	23,9	0.94
16S	25,4	1.00	15,0	0.59	7,1	0.28	34,0	1.34	28,7	1.13
20S	31,8	1.25	15,0	0.59	7,1	0.28	40,4	1.59	35,6	1.40
24S	38,1	1.50	15,0	0.59	7,1	0.28	48,5	1.91	43,4	1.71

ORS silver braze ring

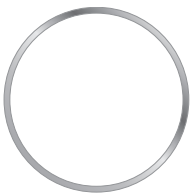

FF9075-(Dash size)

Dash size	Tube O. D.	
	mm	in
19	6,4	0.25
06	9,7	0.38
74	12,7	0.50
08	16,0	0.63
09	19,0	0.75
86	25,4	1.00
87	31,8	1.25
88	38,1	1.50

FIND IT QUICKLY

Want an easy way to find the new Eaton adapter part number?

Just go to **PowerSource Cross Reference** tool and type in the previous adapter part number here.

eatonpowersource.com

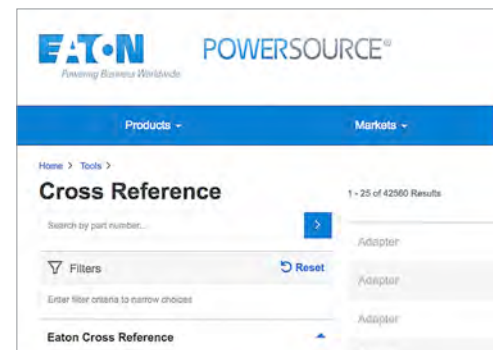

Steel adapters

SAE O-Ring boss/SAE O-Ring boss

J

SAE O-Ring boss/SAE O-Ring boss

SAE O-Ring boss reducer

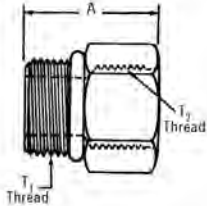

FF1010-(Dash size)
(Formerly Weatherhead Series 7033x)

Dash size	Threads T1	Threads T2	A	
			mm	in
0304S	3/8-24	7/16-20	24,4	0.96
0406S	7/16-20	9/16-18	27,2	1.07
0408S	7/16-20	3/4-16	32,0	1.26
0604S	9/16-18	7/16-20	24,4	0.96
0806S	3/4-16	9/16-18	26,9	1.06
1006S	7/8-14	9/16-18	20,6	0.81
1008S	7/8-14	3/4-16	31,8	1.25
1206S	1 1/16-12	9/16-18	25,4	1.00
1208S	1 1/16-12	3/4-16	25,4	1.00
1210S	1 1/16-12	7/8-14	36,6	1.44
1216S	1 1/16-12	1 5/16-12	45,5	1.79
1412S	1 3/16-12	1 1/16-12	43,7	1.72
1608S	1 5/16-12	3/4-16	25,4	1.00
1610S	1 5/16-12	7/8-14	36,6	1.44
1612S	1 5/16-12	1 1/16-12	40,4	1.59
2012S	1 5/8-12	1 1/16-12	25,4	1.00
2016S	1 5/8-12	1 5/16-12	25,4	1.00
2412S	1 7/8-12	1 1/16-12	39,6	1.56
2416S	1 7/8-12	1 5/16-12	25,4	1.00
2420S	1 7/8-12	1 5/8-12	39,6	1.56

Note: Available without O-Ring, Order FF1009-(dash size)

O-Ring boss plug

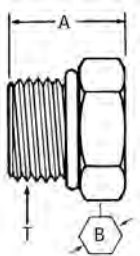

900598-(Dash size) (Ref. SAE 090109A)
(Formerly Weatherhead Series 7237x)

Dash size	Threads T1	A		B	
		mm	in	mm	in
4S	7/16-20	17,0	0.67	14,2	0.56
5S	1/2-20	17,0	0.67	15,7	0.62
6S	9/16-18	18,5	0.73	17,5	0.69
8S	3/4-16	20,3	0.80	22,4	0.88
10S	7/8-14	23,6	0.93	25,4	1.00
12S	1 1/16-12	27,7	1.09	31,8	1.25
14S	1 3/16-12	27,7	1.09	35,1	1.38
16S	1 5/16-12	28,4	1.12	38,1	1.50
20S	1 5/8-12	30,5	1.20	47,8	1.88
24S	1 7/8-12	32,3	1.27	53,8	2.12
32S	2 1/2-12	36,3	1.43	69,9	2.75
2S	5/16-24	15,2	0.60	11,2	0.44
3S	3/8-24	15,2	0.60	12,7	0.50

Note: Available without O-Ring. Order as 900598-1-(dash size).
(Formerly Weatherhead Series B7237x)

SAE O-Ring boss/SAE O-Ring boss

SAE Male O-Ring boss (Hex socket)

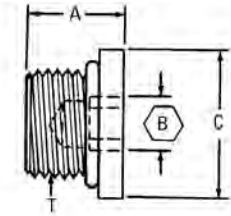

FF2138-(Dash size) (Ref. SAE 090109B)
(Formerly Weatherhead Series 7238x)

Dash size	Tube O.D.		Threads T1	A		C (Round)		Hex	
	mm	in		mm	in	mm	in	mm	in
02S	3,3	0.13	5/16-24	10,2	0.40	11,2	0.44	3,3	0.13
03S	4,8	0.19	3/8-24	10,2	0.40	12,7	0.50	4,0	0.16
04S	6,3	0.25	7/16-20	11,9	0.47	14,3	0.56	4,8	0.19
05S	7,9	0.31	1/2-20	11,9	0.47	16,0	0.63	5,6	0.22
06S	9,6	0.38	9/16-18	12,8	0.50	17,5	0.69	6,4	0.25
08S	12,7	0.5	3/4-16	14,7	0.58	22,3	0.88	8,0	0.32
10S	16,0	0.63	7/8-14	16,5	0.65	25,4	1.00	9,6	0.38
12S	19,0	0.75	1 1/16-12	19,6	0.77	31,8	1.25	14,4	0.57
14S	22,2	0.88	1 3/16-12	19,6	0.77	35,0	1.38	14,4	0.57
16S	25,4	1.00	1 5/16-12	19,6	0.77	38,1	1.50	16,0	0.63
20S	31,8	1.25	1 5/8-12	19,6	0.77	47,8	1.88	19,1	0.75

Note: Available without O-Ring. Order as FF2137-(dash size)
(Formerly Weatherhead series B7238x)

SAE O-Ring boss/adjustable SAE O-Ring boss

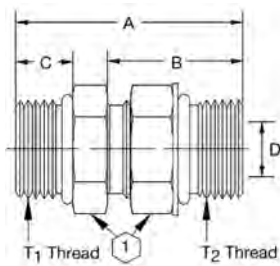

2220-(Dash size)
(Formerly Weatherhead Series C5314x)

Dash size	Threads T1	A		B		D Hole		E Hex		F Hex	
		mm	in	mm	in	mm	in	mm	in	mm	in
4-4S	7/16-20	34,8	1.37	9,1	0.38	4,3	0.17	14,3	0.56	14,3	0.56
6-6S	9/16-18	37,8	1.49	9,9	0.39	7,6	0.30	17,5	0.69	17,5	0.69
8-8S	3/4-16	44,4	1.75	11,1	0.44	9,9	0.39	22,2	0.88	22,2	0.88
10-10S	7/8-14	51,8	2.04	12,7	0.50	12,2	0.48	25,4	1.00	25,4	1.00
12-12S	1 1/16-12	54,1	2.13	15,0	0.59	15,5	0.61	31,8	1.25	31,8	1.25
16-16S	1 5/16-12	59,9	2.36	15,0	0.59	21,3	0.84	38,1	1.50	38,1	1.50
20-20S	1 5/8-12	58,9	2.32	15,0	0.59	27,4	1.08	47,6	1.88	47,6	1.88
24-24S	1 7/8-12	63,0	2.48	15,0	0.59	33,3	1.32	54,0	2.13	54,0	2.13

SAE Male O-Ring boss/ NPTF external pipe

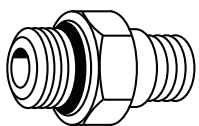

FF1796-(Dash size)
(Formerly Weatherhead Series C3249x)

Dash size	Port size	Male pipe thread	Straight thread B	Hex C		D		L	
				mm	in	mm	in	mm	in
0402S	1/4	1/8	7/16-20	14,3	9/16	4.4	.172	26.7	1.05
0604S	3/8	1/4	9/16-18	17,5	11/16	7.1	.281	33.0	1.30
0806S	1/2	3/8	3/4-16	22,2	7/8	9.9	.391	34.5	1.36
0808S	1/2	1/2	3/4-16	22,2	7/8	9.9	.391	39.4	1.55
1008S	5/8	1/2	7/8-14	25,4	1	12.3	.484	42.9	1.69
1212S	3/4	3/4	1 1/16-12	31,8	1 1/4	15.5	.609	43.9	1.73
1616S	1	1	1 5/16-12	38,1	1 1/2	21.4	.844	52.3	2.06
2020S	1 1/4	1 1/4	1 5/8-12	47,6	1 7/8	27.4	1.078	55.1	2.17
2424S	1 1/2	1 1/2	1 7/8-12	54,0	2 1/8	33.3	1.312	57.4	2.26
3232S	2	2	2 1/2-12	70,0	2 3/4	45.2	1.781	62.7	2.47

Replacement O-Ring on page J-112.

Steel adapters

SAE O-Ring boss/SAE O-Ring boss

J

SAE O-Ring boss/SAE O-Ring boss

Male SAE O-Ring boss/male SAE O-Ring boss

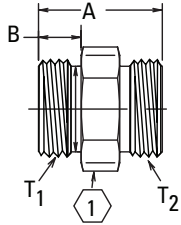

2229-(Dash size)

Dash size	Tube O.D.		Threads T1	Thread T2	A		B		①
	mm	in			mm	in	mm	in	
8-8S	12,7	0.50	3/4-16	3/4-16	30,3	1.19	11,2	0.44	22,3 0.88
16-16S	25,4	1.00	1 5/16-12	1 5/16-12	43,9	1.73	15,0	0.59	38,1 1.50

90° female SAE O-Ring boss/adjustable SAE O-Ring boss male

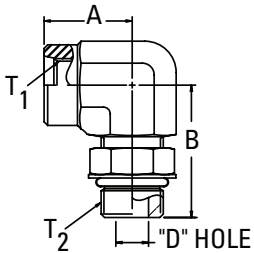

FF2591-(Dash size)

Dash size	Tube O.D.		Threads T1	Thread T2	A		B	
	mm	in			mm	in	mm	in
0404S	6,4	0.25	7/16-20	7/16-20	21,6	0.85	32,0	1.26

SAE O-Ring boss (adj.)/hose connector

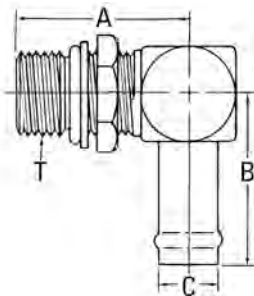

FF1167-(Dash size)

Dash size	Tube O.D.		Threads T1	A		B		C	
	mm	in		mm	in	mm	in	mm	in
1212S	19,0	0.75	1 1/16-12	49,8	1.96	52,3	2.06	19,0	0.75

Note: Available without O-Ring - order by FF1161-(dash size).
Clamp required.

Pipe to pipe

NPTE external pipe/ NPTF external pipe

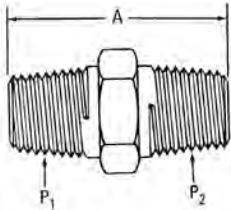

2083-(Dash size) (Ref. SAE 140137)
(Formerly Weatherhead series C3069x)

Dash size	Threads P1	Thread P2	A	
			mm	in
1-1S	1/16-27	1/16-27	23,9	0.94
2-1S	1/8-27	1/16-27	24,6	0.97
2-2S*	1/8-27	1/8-27	26,9	1.06
4-2S*	1/4-18	1/8-27	32,0	1.26
4-4S*	1/4-18	1/4-18	36,8	1.45
6-2S	3/8-18	1/8-27	31,8	1.25
6-4S*	3/8-18	1/4-18	36,8	1.45
6-6S*	3/8-18	3/8-18	36,8	1.45
8-4S	1/2-14	1/4-18	43,2	1.70
8-6S	1/2-14	3/8-18	43,2	1.70
8-8S*	1/2-14	1/2-14	48,0	1.89
12-6S	3/4-14	3/8-18	45,0	1.77
12-8S	3/4-14	1/2-14	49,8	1.96
12-12S*	3/4-14	3/4-14	49,8	1.96
16-12S	1-11 1/2	3/4-14	54,6	2.15
16-16S*	1-11 1/2	1-11 1/2	59,4	2.34
20-16S	1 1/4-11 1/2	1-11 1/2	62,2	2.45
20-20S*	1 1/4-11 1/2	1 1/4-11 1/2	63,0	2.48
24-24S*	1 1/2-11 1/2	1 1/2-11 1/2	66,3	2.61
32-32S	2-11 1/2	2-11 1/2	71,6	2.82

* Also available in stainless steel as part number 259-2083-(dash size)
(formerly Weatherhead 3081x).

NPTF external pipe/NPSM external pipe

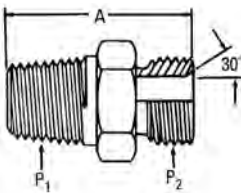

2015-(Dash size)

Dash size	Threads P1	Thread P2	A	
			mm	in
8-8S	1/2-14	1/2-14	38,1	1.50
12-12S	3/4-14	3/4-14	41,1	1.62
16-16S	1-11 1/2	1-11 1/2	48,5	1.91
24-24S	1 1/2-11 1/2	1 1/2-11 1/2	54,4	2.14

Steel adapters

Pipe to pipe

J

Pipe to pipe

NPTF bulkhead coupling

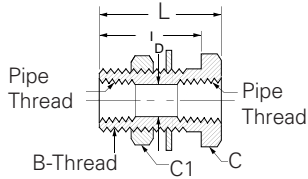
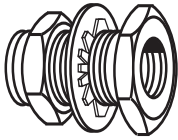

FF4183-(Dash size)
(Formerly Weatherhead Series W)

Dash size	Female pipe thread	Thread Size B	Hex C		Hex C1		D		I		L	
			mm	in	mm	in	mm	in	mm	in	mm	in
-0404-1S	1/4	3/4-16	25,4	1	26,9	1-1/16	10,7	.422	31,8	1,25	38,1	1,50
-0404-2S	1/4	3/4-16	25,4	1	26,9	1-1/16	10,7	.422	17,5	.69	23,9	.94
-0606S	3/8	1-14	28,6	1-1/8	34,9	1-3/8	14,3	.563	26,9	1,06	33,3	1,31

NPTF bulkhead coupling

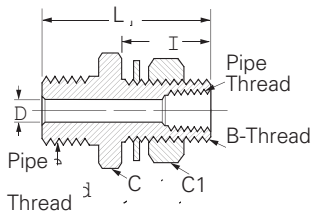
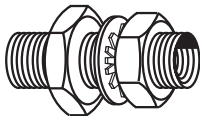

FF4185-(Dash size)
(Formerly Weatherhead Series W)

Dash size	Male pipe thread	Female pipe thread	Thread Size B	Hex C		Hex C1		D		I		L	
				mm	in	mm	in	mm	in	mm	in	mm	in
-0804-1S	1/2	1/4	3/4-16	31,8	1-1/4	26,9	1-1/16	7,9	.312	28,7	1,13	54,8	2,16
-0804-2S	1/2	1/4	3/4-16	31,8	1-1/4	26,9	1-1/16	7,9	.312	38,8	1,53	64,2	2,53

NPTF bulkhead coupling

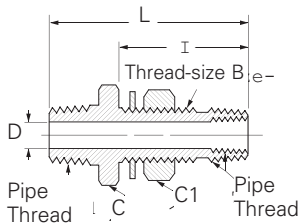
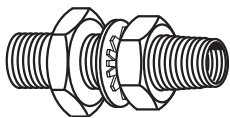

FF4186-(Dash size)
(Formerly Weatherhead Series W)

Dash size	Male pipe thread	Female pipe thread	Thread Size B	Hex C		Hex C1		D		I		L	
				mm	in	mm	in	mm	in	mm	in	mm	in
-0804-1S	1/2	1/4	1-14	31,8	1-1/4	34,9	1-3/8	9,5	.375	47,6	1,88	74,7	2,94
-0804-2S	1/2	1/4	1-14	31,8	1-1/4	34,9	1-3/8	9,5	.375	73,2	2,88	100,0	3,94

Pipe to pipe

NPTF external pipe/ NPTF external pipe

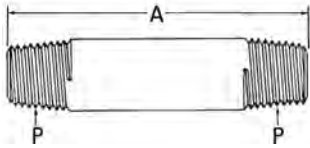

2084-(Dash size)

Dash size	Threads T1	A	
		mm	in
2S-3/4	1/8-27	19,0	0.75
2S-2	1/8-27	50,8	2.00
4S-7/8	1/4-18	22,3	0.88
4S-2	1/4-18	50,8	2.00
4S-3	1/4-18	76,2	3.00
4S-4	1/4-18	101,6	4.00
6S-1	3/8-18	25,4	1.00
6S-2	3/8-18	50,8	2.00
6S-3	3/8-18	76,2	3.00
6S-4	3/8-18	101,6	4.00
6S-6	3/8-18	152,4	6.00
8S-1 1/8	1/2-14	28,5	1.12
8S-2 1/2	1/2-14	63,5	2.50
12S-1 3/8	3/4-14	35,1	1.38
16S-1 1/2	1-11 1/2	38,1	1.50
20S-1 5/8	1 1/4-11 1/2	41,1	1.62
24S-1 3/4	1 1/2-11 1/2	44,4	1.75

NPTF reducer-external pipe/ NPTF internal pipe

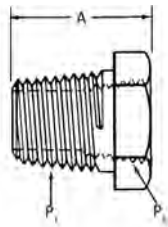
2081-(Dash size) (Ref. SAE 140140)
(Formerly Weatherhead series C3109x)

Dash size	Thread P1	Thread P2	A	
			mm	in
4-2S*	1/4-18	1/8-27	21,6	0.85
6-2S*	3/8-18	1/8-27	21,6	0.85
6-4S*	3/8-18	1/4-18	25,4	1.00
8-2S	1/2-14	1/8-27	27,9	1.10
8-4S*	1/2-14	1/4-18	27,9	1.10
8-6S*	1/2-14	3/8-18	28,4	1.12
12-4S*	3/4-14	1/4-18	29,7	1.17
12-6S	3/4-14	3/8-18	29,7	1.17
12-8S	3/4-14	1/2-14	34,5	1.36
16-4S	1-11 1/2	1/4-18	34,5	1.36
16-6S	1-11 1/2	3/8-14	34,5	1.36
16-8S*	1-11 1/2	1/2-14	34,5	1.36
16-12S*	1-11 1/2	3/4-14	37,8	1.49
20-8S	1 1/4-11 1/2	1/2-14	37,3	1.47
20-12S*	1 1/4-11 1/2	3/4-14	37,3	1.47
20-16S*	1 1/4-11 1/2	1-11 1/2	40,9	1.61
24-12S	1 1/2-11 1/2	3/4-14	39,9	1.57
24-16S	1 1/2-11 1/2	1-11 1/2	39,9	1.57
24-20S	1 1/2-11 1/2	1 1/4-11 1/2	39,9	1.57
32-16S*	2-11 1/2	1-11 1/2	44,5	1.75
32-20S*	2-11 1/2	1 1/4-11 1/2	44,5	1.75
32-24S	2-11 1/2	1 1/2-11 1/2	44,5	1.75

* Also available in stainless steel as part number 259-2081-(dash size)
(formerly Weatherhead 3121x)

Steel adapters

Pipe to pipe

J

Pipe to pipe

NPTF external pipe/Plug

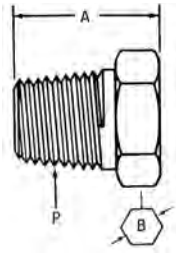

2082-(Dash size) (Ref. SAE 140109E)
(Formerly Weatherhead series C3159x)

Dash size	Threads P1	A		B	
		mm	in	mm	in
2S*	1/8-27	14,7	0.58	11,2	0.44
4S*	1/4-18	19,3	0.76	14,2	0.56
6S*	3/8-18	20,1	0.79	22,3	0.69
8S	1/2-14	24,9	0.98	22,4	0.88
12S	3/4-14	27,4	1.08	26,9	1.06
16S	1-11 1/2	32,3	1.27	44,4	1.31
20S	1 1/4-11 1/2	33,0	1.30	44,5	1.75
24S	1 1/2-11 1/2	33,8	1.33	50,8	2.00
32S	2-11 1/2	35,3	1.39	60,5	2.38

* Also available in stainless steel as part number 259-2082-(dash Size)
(formerly Weatherhead 3171x)

NPTF square head plug thread

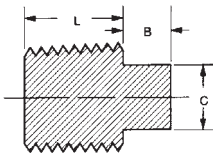
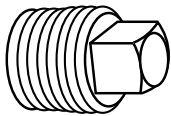

FF4177-(Dash size)
(Formerly Weatherhead series C3179x)

Dash size	Male pipe thread	B		C		L	
		mm	in	mm	in	mm	in
02S	1/8	6,4	0.25	7,1	0.28	8,6	0.34
04S	1/4	7,4	0.29	9,7	0.38	13,0	0.51
06S	3/8	8,1	0.32	11,2	0.44	13,0	0.51
08S	1/2	10,2	0.40	14,2	0.56	17,3	0.68
12S	3/4	11,7	0.46	16,0	0.63	17,5	0.69
16S	1	13,2	0.52	16,7	0.81	21,6	0.85

Seal-nut for NPTF male pipe thread

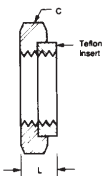

FF91494-(Dash size)
(Formerly Weatherhead series C3059x)

Dash size	Pipe thread	Hex C		L	
		mm	in	mm	in
02S	1/8	15,9	5/8	3,8	.15
04S	1/4	19,5	3/4	6,4	.25
06S	3/8	22,2	7/8	6,4	.25
08S	1/2	28,6	1 1/8	6,4	.25
12S	3/4	33,3	1 5/16	6,4	.25
16S	1	41,3	1 5/8	8,6	.34

Pipe to pipe

NPTF external pipe/Plug countersunk hex

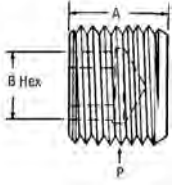

2222-(Dash size) (Ref. SAE 140109N)
(Formerly Weatherhead series C3169x)

Dash size	Threads P1	A		B	
		mm	in	mm	in
2S	1/8-27	7,6	0.30	4,8	0.19
4S	1/4-18	11,7	0.46	6,4	0.25
6S	3/8-18	11,7	0.46	7,9	0.31
8S	1/2-14	15,5	0.61	9,7	0.38

NPTF external pipe/ NPTF internal pipe

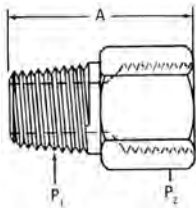

2040-(Dash size) (Ref. SAE 140139)
(Formerly Weatherhead series C3209x)

Dash size	Threads P1	Threads P2	A	
			mm	in
2-2S	1/8-27	1/8-27	26,4	1.04
2-4S	1/8-27	1/4-18	30,7	1.21
2-8S	1/8-27	1/2-14	38,1	1.50
4-4S	1/4-18	1/4-18	35,3	1.39
4-6S	1/4-18	3/8-18	36,6	1.44
4-8S	1/4-18	1/2-14	42,7	1.68
4-12S	1/4-18	3/4-14	44,2	1.74
6-6S	3/8-18	3/8-18	36,6	1.44
6-8S	3/8-18	1/2-14	42,7	1.68
8-8S	1/2-14	1/2-14	47,5	1.87
8-12S	1/2-14	3/4-14	49,0	1.93
8-16S	1/2-14	1-11 1/2	53,1	2.09
12-12S	3/4-14	3/4-14	49,0	1.93
12-16S	3/4-14	1-11 1/2	55,4	2.18
16-16S	1-11 1/2	1-11 1/2	60,2	2.37
16-20S	1-11 1/2	1 1/4-11 1/2	62,5	2.46
20-20S	1 1/4-11 1/2	1 1/4-11 1/2	63,2	2.49
20-24S	1 1/4-11 1/2	1 1/2-11 1/2	63,5	2.50
24-24S	1 1/2-11 1/2	1 1/2-11 1/2	64,3	2.53
24-32S	1 1/2-11 1/2	2-11 1/2	66,8	2.63
32-32S	2-11 1/2	2-11 1/2	67,6	2.66

Steel adapters

Pipe to pipe

J

Pipe to pipe

NPSM internal pipe swivel/NPTF external pipe

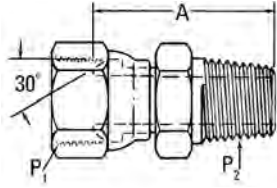

2045-(Dash size) (Ref. SAE 140130)
(Formerly Weatherhead series 9205x)

Dash size	Threads P1	Threads P2	A	
			mm	in
2-2S	1/8-27	1/8-27	24,4	0.96
2-4S	1/8-27	1/4-18	29,0	1.14
4-4S	1/4-18	1/4-18	32,0	1.26
4-6S	1/4-18	3/8-18	32,0	1.26
4-8S	1/4-18	1/2-14	38,4	1.51
6-4S	3/8-18	1/4-18	32,0	1.26
6-6S	3/8-18	3/8-18	33,5	1.32
6-8S	3/8-18	1/2-14	40,1	1.58
8-6S	1/2-14	3/8-18	34,8	1.37
8-8S	1/2-14	1/2-14	41,1	1.62
8-12S	1/2-14	3/4-14	41,1	1.62
12-8S	3/4-14	1/2-14	44,4	1.75
12-12S	3/4-14	3/4-14	44,5	1.75
12-16S	3/4-14	1-11 1/2	50,8	2.00
16-12S	1-11 1/2	3/4-14	44,7	1.76
16-16S	1-11 1/2	1-11 1/2	51,3	2.02
16-20S	1-11 1/2	1 1/4-11 1/2	52,8	2.08
20-16S	1 1/4-11 1/2	1-11 1/2	53,3	2.10
20-20S	1 1/4-11 1/2	1 1/4-11 1/2	52,8	2.08
20-24S	1 1/4-11 1/2	1 1/2-11 1/2	54,4	2.14
24-20S	1 1/2-11 1/2	1 1/4-11 1/2	55,1	2.17
24-24S	1 1/2-11 1/2	1 1/2-11 1/2	55,9	2.20
32-32S	2-11 1/2	2-11 1/2	60,7	2.39

NPSM Internal pipe swivel/ NPTF external pipe

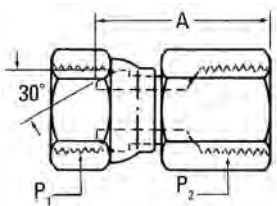

2046-(Dash size) (Ref. SAE 140131)
(Formerly Weatherhead series 9255x)

Dash size	Threads P1	Threads P2	A	
			mm	in
2-2S	1/8-27	1/8-27	23,9	0.94
2-4S	1/8-27	1/4-18	26,9	1.06
4-4S	1/4-18	1/4-18	33,0	1.30
4-6S	1/4-18	3/8-18	33,3	1.31
6-6S	3/8-18	3/8-18	33,8	1.33
6-8S	3/8-18	1/2-14	36,8	1.45
8-6	1/2-14	3/8-18	35,3	1.39
8-8S	1/2-14	1/2-14	39,6	1.56
12-12S	3/4-14	3/4-14	45,0	1.77
12-16S	3/4-14	1-11 1/2	51,8	2.04
16-16S	1-11 1/2	1-11 1/2	52,3	2.06
20-20S	1 1/4-11 1/2	1 1/4-11 1/2	52,3	2.06
24-24S	1 1/2-11 1/2	1 1/2-11 1/2	55,4	2.18
32-32S	2-11 1/2	2-11 1/2	58,4	2.30

Pipe to pipe

Coupling – NPTF internal pipe/internal pipe

2096-(Dash size) (Ref. SAE 140138)
(Formerly Weatherhead series C3309x)

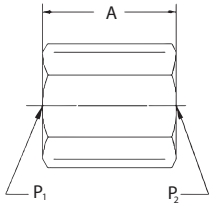

Dash size	Threads P1	Thread P2	A	
			mm	in
2S	1/8-27	1/8-27	19,1	0.75
4-2S*	1/4-18	1/8-27	28,7	1.13
4S*	1/4-18	1/4-18	28,7	1.13
6-4S	3/8-18	1/4-18	28,7	1.13
6S*	3/8-18	3/8-18	28,7	1.13
8-4S	1/2-14	1/4-18	38,1	1.50
8-6S	1/2-14	3/8-18	38,1	1.50
8S*	1/2-14	1/2-14	38,1	1.50
12-8S	3/4-14	1/2-14	38,9	1.53
12S*	3/4-14	3/4-14	38,9	1.53
16-12S	1-11 1/2	3/4-14	48,0	1.89
16S	1-11 1/2	1-11 1/2	48,0	1.89
20S*	1 1/4-11 1/2	1 1/4-11 1/2	49,0	1.93
24S	1 1/2-11 1/2	1 1/2-11 1/2	49,0	1.93
32S	2-11 1/2	2-11 1/2	49,8	1.96

* Also available in stainless steel as part number 259-2096-(dash size).
(formerly Weatherhead 3321x)

NPTF external pipe/external pipe

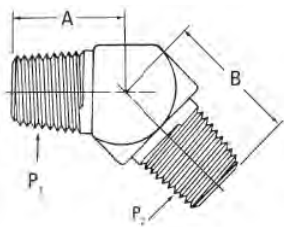

2247-(Dash size) (Ref. SAE 140337)

Dash size	Threads P1	Thread P2	A		B	
			mm	in	mm	in
2-2S	1/8-27	1/8-27	17,0	0.67	17,0	0.67
4-4S	1/4-18	1/4-18	21,8	0.86	21,8	0.86
6-4S	3/8-18	1/4-18	24,1	0.95	24,1	0.95
6-6S	3/8-18	3/8-18	24,1	0.95	24,1	0.95
8-8S	1/2-14	1/2-14	28,7	1.13	29,7	1.17
12-12S	3/4-14	3/4-14	29,7	1.17	30,5	1.20
16-16S	1-11 1/2	1-11 1/2	30,5	1.20	37,6	1.48
20-20S	1 1/4-11 1/2	1 1/4-11 1/2	47,7	1.88	39,1	1.54

NPSM Internal pipe swivel/ NPTF internal pipe

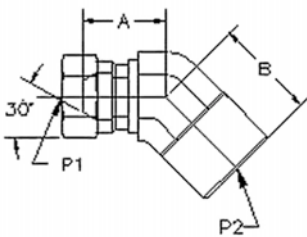

2050-(Dash size) (Ref. SAE 140331)
(Formerly Weatherhead series 9385x)

Dash size	Threads P1	Thread P2	A		B	
			mm	in	mm	in
2-2S	1/8-27	1/8-27	15,7	0.62	12,7	0.50
4-4S	1/4-18	1/4-18	20,1	0.79	24,6	0.97
4-6S	1/4-18	3/8-18	23,4	0.92	30,0	1.18
6-6S	3/8-18	3/8-18	23,4	0.92	30,0	1.18
6-8S	3/8-18	1/2-14	21,8	0.86	35,8	1.41
8-8S	1/2-14	1/2-14	23,1	0.91	35,8	1.41
12-12S	3/4-14	3/4-14	27,9	1.10	38,9	1.53
16-16S	1-11 1/2	1-11 1/2	32,0	1.26	38,9	1.53
20-20S	1 1/4-11 1/2	1 1/4-11 1/2	31,2	1.23	36,6	1.44

Steel adapters

Pipe to pipe

J

Pipe to pipe

NPSM internal pipe swivel/NPTF external pipe

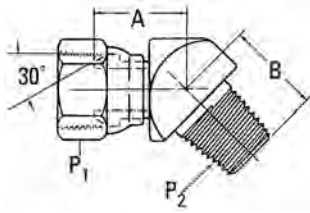

2049-(Dash size) (Ref. SAE 140330)
(Formerly Weatherhead series 9355x)

Dash size	Threads P1	Thread P2	A		B	
			mm	in	mm	in
2-2S	1/8-27	1/8-27	17,0	0.67	17,8	0.70
4-2S	1/4-18	1/8-27	20,1	0.79	17,0	0.67
4-4S	1/4-18	1/4-18	20,1	0.79	24,6	0.97
4-6S	1/4-18	3/8-18	20,3	0.80	26,9	1.06
4-8S	1/4-18	1/2-14	21,1	0.83	35,8	1.41
6-4S	3/8-18	1/4-18	23,4	0.92	25,4	1.00
6-6S	3/8-18	3/8-18	23,4	0.92	27,7	1.09
6-8S	3/8-18	1/2-14	23,4	0.92	35,8	1.41
8-6S	1/2-14	3/8-18	23,1	0.91	27,7	1.09
8-8S	1/2-14	1/2-14	23,1	0.91	35,8	1.41
8-12S	1/2-14	3/4-14	23,1	0.91	38,9	1.53
12-8S	3/4-14	1/2-14	27,9	1.10	38,9	1.53
12-12S	3/4-14	3/4-14	27,9	1.10	38,9	1.53
12-16S	3/4-14	1-11 1/2	26,2	1.03	38,1	1.50
16-12S	1-11 1/2	1/4-14	32,0	1.26	38,9	1.53
16-16S	1-11 1/2	1-11 1/2	32,0	1.26	38,9	1.53
16-20S	1-11 1/2	1 1/4-11 1/2	33,0	1.30	46,7	1.84
20-20S	1 1/4-11 1/2	1 1/4-11 1/2	36,8	1.45	46,7	1.84
24-24S	1 1/2-11 1/2	1 1/2-11 1/2	35,8	1.41	50,8	2.00

NPTF internal pipe/NPTF external pipe

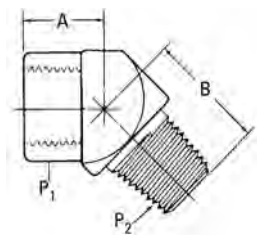

2088-(Dash size) (Ref. SAE 140339)
(Formerly Weatherhead series C3359x)

Dash size	Threads P1	Thread P2	A		B	
			mm	in	mm	in
2-2S	1/8-27	1/8-27	11,9	0.47	18,3	0.72
4-4S	1/4-18	1/4-18	15,7	0.62	26,7	1.05
6-6S	3/8-18	3/8-18	18,3	0.72	26,9	1.06
8-8S	1/2-14	1/2-14	23,1	0.91	34,0	1.34
12-12S	3/4-14	3/4-14	24,6	0.97	35,1	1.38
16-16S	1-11 1/2	1-11 1/2	28,4	1.12	43,7	1.72

Pipe to pipe

NPTF 45° Female pipe elbow

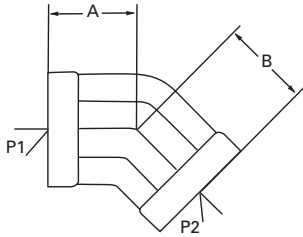

2086-S-(Dash size) (Ref. SAE 140338)
(Formerly Weatherhead series C3559x)

Dash size	Thread P1	Thread P2	A		B	
			mm	in	mm	in
4-4S	1/4-18	1/4-18	17,5	0.69	17,5	0.69
6-6S	3/8-18	3/8-18	19,0	0.75	19,0	0.75
8-8S	1/2-14	1/2-14	23,9	0.94	23,9	0.94
12-12S	3/4-14	3/4-14	25,4	1.00	25,4	1.00
16-16S	1-11 1/2	1-11 1/2	30,2	1.19	30,2	1.19

NPTF external pipe/NPTF external pipe

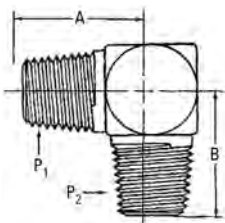

2085-(Dash size) (Ref. SAE 140237)
(Formerly Weatherhead series C3529x)

Dash size	Threads P1	Thread P2	A		B	
			mm	in	mm	in
2-2S	1/8-27	1/8-27	19,8	0.78	19,8	0.78
4-4S	1/4-18	1/4-18	27,7	1.09	27,7	1.09
6-4S	3/8-18	1/4-18	31,0	1.22	31,0	1.22
6-6S	3/8-18	3/8-18	31,0	1.22	31,0	1.22
8-6S	1/2-14	3/8-18	37,3	1.47	32,5	1.28
8-8S	1/2-14	1/2-14	37,3	1.47	37,3	1.47
12-8S	3/4-14	1/2-14	40,4	1.59	40,4	1.59
12-12S	3/4-14	3/4-14	40,4	1.59	40,4	1.59
16-12S	1-11 1/2	3/4-14	50,0	1.97	45,2	1.78
16-16S	1-11 1/2	1-11 1/2	50,0	1.97	50,0	1.97

Steel adapters

Pipe to pipe

J

Pipe to pipe

NPTF external pipe/hose Connector

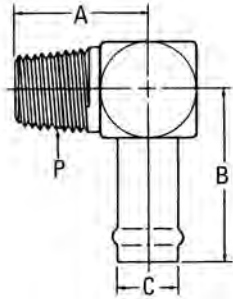

FF1162-(Dash size) (Ref. SAE 430260)

Dash size	Tube O.D.		Threads T1	A		B		C	
	mm	in		mm	in	mm	in	mm	in
0406S	9,7	0.38	1/4-18	27,7	1.09	39,1	1.54	9,7	0.38
1212S	19,0	0.75	3/4-14	35,8	1.41	46,5	1.83	19,0	0.75
1616S	25,4	1.00	1-11 1/2	50,0	1.97	49,3	1.94	25,4	1.00
2020S	31,8	1.25	1 1/4-11 1/2	49,8	1.96	54,6	2.15	31,7	1.25

Note: Clamp required.

NPTF external pipe swivel/ NPTF external pipe

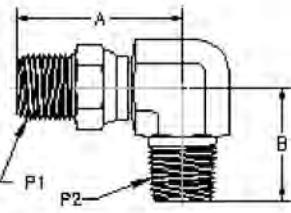

2251-(Dash size)

(Formerly Weatherhead series 9435x)

Dash size	Threads P1	Thread P2	A		B	
			mm	in	mm	in
4-4S	1/4-18	1/4-18	43,7	1.72	27,7	1.09
6-6S	3/8-18	3/8-18	45,2	1.78	31,0	1.22
8-8S	1/2-14	1/2-14	54,4	2.14	37,3	1.47
12-12S	3/4-14	3/4-14	66,3	2.61	40,4	1.59

Note: The above adapter is not a rotating union or swivel joint. Care must be exercised to avoid misuse. To be used with petroleum or water glycol fluids.

NPTF external pipe/ NPTF internal pipe

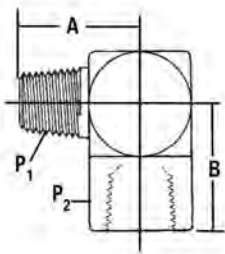

2089-(Dash size) (Ref. SAE 140239)

(Formerly Weatherhead series C3409x)

Dash size	Threads P1	Thread P2	A		B	
			mm	in	mm	in
2-2S	1/8-27	1/8-27	19,8	0.78	16,8	0.66
2-4S	1/8-27	1/4-18	22,9	0.90	22,4	0.88
4-2S	1/4-18	1/8-27	27,7	1.09	17,0	0.67
4-4S	1/4-18	1/4-18	27,7	1.09	22,4	0.88
4-6S	1/4-18	3/8-18	31,0	1.22	25,9	1.02
6-4S	3/8-18	1/4-18	31,0	1.22	25,7	1.01
6-6S*	3/8-18	3/8-18	31,0	1.22	25,9	1.02
6-8S	3/8-18	1/2-14	32,5	1.28	31,2	1.23
8-6S	1/2-14	3/8-18	37,3	1.47	25,7	1.01
8-8S	1/2-14	1/2-14	37,3	1.47	31,2	1.23
8-12S	1/2-14	3/4-14	40,4	1.59	34,5	1.36
12-8S	3/4-14	1/2-14	40,4	1.59	34,3	1.35
12-12S	3/4-14	3/4-14	40,4	1.59	34,5	1.36
16-16S	1-11 1/2	1-11 1/2	50,0	1.97	41,1	1.62
20-20S	1 1/4-11 1/2	1 1/4-11 1/2	60,5	2.38	43,2	1.70
24-24S	1 1/2-11 1/2	1 1/2-11 1/2	67,1	2.64	52,8	2.08
32-32S	2-11 1/2	2-11 1/2	76,2	3.00	60,7	2.39

* Also available in stainless steel as part number 259-2089-(dash Size). (Formerly Weatherhead 3421x)

Pipe to pipe

NPTF external pipe swivel/ NPTF internal pipe

2252-(Dash size)

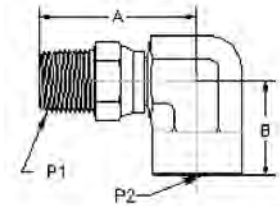

Dash size	Threads P1	Thread P2	A		B	
			mm	in	mm	in
2-2S	1/8-27	1/8-27	35,1	1.38	17,3	0.68
4-4S	1/4-18	1/4-18	43,7	1.72	22,4	0.88
6-6S	3/8-18	3/8-18	45,2	1.78	25,9	1.02
8-8S	1/2-14	1/2-14	54,4	2.14	31,2	1.23
12-12S	3/4-14	3/4-14	66,3	2.61	40,4	1.59

Note: The above adapter is not a rotating union or swivel joint. Care must be exercised to avoid misuse. To be used with petroleum or water glycol fluids.

NPSM internal pipe swivel/NPTF internal pipe

2048-(Dash size) (Ref. SAE 140231) (Formerly Weatherhead series 9455x)

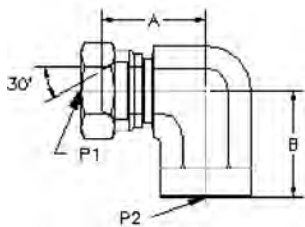

Dash size	Threads P1	Thread P2	A		B	
			mm	in	mm	in
2-2S	1/8-27	1/8-27	19,8	0.78	16,8	0.66
4-4S	1/4-18	1/4-18	23,1	0.91	24,6	1.0
4-6S	1/4-18	3/8-18	25,4	1.00	27,7	1.09
4-8S	1/4-18	1/2-14	27,7	1.09	33,0	1.30
6-4S	3/8-18	1/4-18	24,6	0.97	24,6	0.97
6-6S	3/8-18	3/8-18	27,7	1.09	27,7	1.09
6-8S	3/8-18	1/2-14	27,9	1.10	34,0	1.34
8-6S	1/2-14	3/8-18	27,4	1.08	34,0	1.34
8-8S	1/2-14	1/2-14	27,4	1.08	34,0	1.34
8-12S	1/2-14	3/4-14	37,3	1.47	34,5	1.36
12-8S	3/4-14	1/2-14	31,5	1.24	31,2	1.23
12-12S	3/4-14	3/4-14	34,5	1.36	38,9	1.53
16-16S	1-11 1/2	1-11 1/2	39,6	1.56	45,2	1.78
20-20S	1 1/4-11 1/2	1 1/4-11 1/2	46,2	1.82	51,6	2.03
24-24S	1 1/2-11 1/2	1 1/2-11 1/2	51,3	2.02	57,9	2.28

Steel adapters

Pipe to pipe

J

Pipe to pipe

NPSM internal pipe swivel/ NPTF external pipe

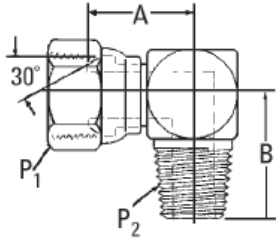

2047-(Dash size) (Ref. SAE 140230)
(Formerly Weatherhead series 9405x)

Dash size	Threads P1	Thread P2	A		B	
			mm	in	mm	in
2-2S	1/8-27	1/8-27	18,0	0.71	26,2	1.03
2-4S	1/8-27	1/4-18	19,6	0.77	27,7	1.09
4-2S	1/4-18	1/8-27	22,4	0.88	22,9	0.90
4-4S	1/4-18	1/4-18	23,1	0.91	32,5	1.28
4-6S	1/4-18	3/8-18	27,7	1.09	38,9	1.53
4-8S	1/4-18	1/2-14	26,2	1.03	46,7	1.84
6-4S	3/8-18	1/4-18	25,1	0.99	31,0	1.22
6-6S	3/8-18	3/8-18	27,7	1.09	38,9	1.53
6-8S	3/8-18	1/2-14	26,2	1.03	46,7	1.84
6-12S	3/8-18	3/4-14	32,0	1.26	40,4	1.59
8-6S	1/2-14	3/8-18	27,4	1.08	41,9	1.65
8-8S	1/2-14	1/2-14	27,4	1.08	46,7	1.84
8-12S	1/2-14	3/4-14	31,5	1.24	51,6	2.03
12-8S	3/4-14	1/2-14	34,5	1.36	51,6	2.03
12-12S	3/4-14	3/4-14	34,5	1.36	51,6	2.03
12-16S	3/4-14	1-11 1/2	38,4	1.51	61,2	2.41
16-12S	1-11 1/2	3/4-14	38,9	1.53	56,4	2.22
16-16S	1-11 1/2	1-11 1/2	38,9	1.53	61,2	2.41
20-20S	1 1/4-11 1/2	1 1/4-11 1/2	46,2	1.82	67,3	2.65
24-24S	1 1/2-11 1/2	1 1/2-11 1/2	51,3	2.02	72,1	2.84
32-32S	2-11 1/2	2-11 1/2	60,2	2.37	84,8	3.34

90° Elbow long – Female pipe swivel/NPTF male pipe

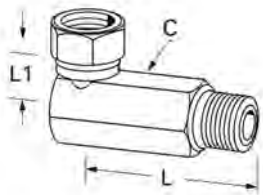

FF4175-(Dash size)
(Formerly Weatherhead series 9405xLL)

Dash size	NPSM Swivel nut	Male pipe thread	Hex C		L		L1	
			mm	in	mm	in	mm	in
0202S	1/8-27	1/8-27	14,2	0.56	48,2	1.90	17,8	0.70
0404S	1/4-18	1/4-18	17,5	0.69	65,3	2.57	19,5	0.75
0606S	3/8-18	3/8-18	20,6	0.81	80,3	3.16	22,9	0.90
0808S	1/2-14	1/2-14	25,4	1.00	93,2	3.67	25,9	1.02
1212S	3/4-14	3/4-14	31,8	1.25	109,0	4.29	30,5	1.20
1616S	1-11 1/2	1-11 1/2	38,1	1.50	128,5	5.06	37,1	1.46

Pipe to pipe

NPTF internal pipe/NPTF internal pipe

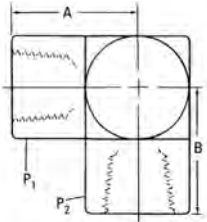

2087-(Dash size) (Ref. SAE 140238)
(Formerly Weatherhead series C3509x)

Dash size	Threads P1	Thread P2	A		B	
			mm	in	mm	in
2-2S	1/8-27	1/8-27	16,8	0.66	16,8	0.66
4-2S	1/4-18	1/8-27	22,4	0.88	17,0	0.67
4-4S*	1/4-18	1/4-18	22,4	0.88	22,4	0.88
6-4S	3/8-18	1/4-18	25,9	1.02	25,7	1.01
6-6S	3/8-18	3/8-18	25,9	1.02	25,9	1.02
8-6S	1/2-14	3/8-18	31,2	1.23	25,7	1.01
8-8S	1/2-14	1/2-14	31,2	1.23	31,2	1.23
12-8S	3/4-14	1/2-14	34,5	1.36	34,3	1.35
12-12S	3/4-14	3/4-14	34,5	1.36	34,5	1.36
16-12S	1-11 1/2	3/4-14	41,1	1.62	35,3	1.39
16-16S	1-11 1/2	1-11 1/2	41,1	1.62	41,1	1.62
20-20S	1 1/4-11 1/2	1 1/4-11 1/2	43,2	1.70	43,2	1.70
24-24S	1 1/2-11 1/2	1 1/2-11 1/2	52,8	2.08	52,8	2.08

* Also available in stainless steel as part number 259-2087-(dash size).
(Formerly Weatherhead 3521x)

NPTF external pipe/NPTF external pipe

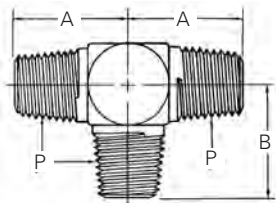

2257-(Dash size)

Dash size	Threads P1	A		B	
		mm	in	mm	in
2-2S	1/8-27	19,8	0.78	19,8	0.78
4-4S	1/4-18	27,7	1.09	27,7	1.09
6-6S	3/8-18	31,0	1.22	31,0	1.22
8-8S	1/2-14	37,3	1.47	37,3	1.47
12-12S	3/4-14	40,4	1.59	40,4	1.59
16-16S	1-11 1/2	50,0	1.97	50,0	1.97

Steel adapters

Pipe to pipe

J

Pipe to pipe

NPTF external pipe/NPTF internal pipe

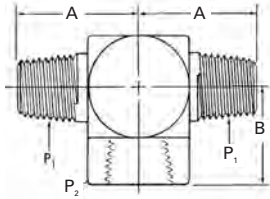

2256-(Dash size)

Dash size	Threads P1	Thread P2	A		B	
			mm	in	mm	in
2-2S	1/8-27	1/8-27	19,8	0.78	16,8	0.66
4-4S	1/4-18	1/4-18	27,7	1.09	22,3	0.88
6-6S	3/8-18	3/8-18	31,0	1.22	25,9	1.02
8-8S	1/2-14	1/2-14	37,3	1.47	31,2	1.23
12-12S	3/4-14	3/4-14	40,4	1.59	34,5	1.36
16-16S	1-11 1/2	1-11 1/2	65,3	2.57	43,2	1.70

NPTF external pipe/NPTF internal pipe

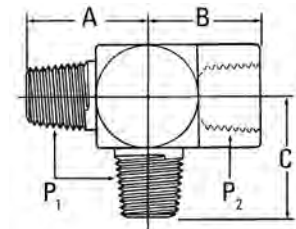

2093-(Dash size)

(Formerly Weatherhead series C3805x)

Dash size	Threads P1	Thread P2	A		B		C	
			mm	in	mm	in	mm	in
2-2S	1/8-27	1/8-27	19,8	0.78	16,8	0.66	19,8	0.78
4-4S	1/4-18	1/4-18	27,7	1.09	22,3	0.88	27,7	1.09
6-6S	3/8-18	3/8-18	31,0	1.22	25,9	1.02	31,0	1.22
8-8S	1/2-14	1/2-14	37,3	1.47	31,2	1.23	37,3	1.47
12-12S	3/4-14	3/4-14	40,4	1.59	34,5	1.36	40,4	1.59
16-16S	1-11 1/2	1-11 1/2	50,0	1.97	41,1	1.62	50,0	1.97

NPTF external pipe/NPTF internal pipe

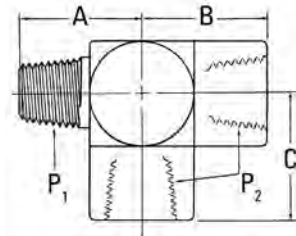

2092-(Dash size) (Ref. SAE 140424)

(Formerly Weatherhead series C3759x)

Dash size	Threads P1	Thread P2	A		B		C	
			mm	in	mm	in	mm	in
2-2S	1/8-27	1/8-27	19,8	0.78	16,8	0.66	16,8	0.66
4-4S	1/4-18	1/4-18	27,7	1.09	22,4	0.88	22,4	0.88
6-6S	3/8-18	3/8-18	31,0	1.22	25,9	1.02	25,9	1.02
8-8S	1/2-14	1/2-14	37,3	1.47	31,2	1.23	31,2	1.23
12-12S	3/4-14	3/4-14	40,4	1.59	34,5	1.36	34,5	1.36
16-16S	1-11 1/2	1-11 1/2	50,0	1.97	41,1	1.62	41,1	1.62
20-20S	1 1/4-11 1/2	1 1/4-11 1/2	60,5	2.38	43,2	1.70	43,2	1.70

Pipe to pipe

NPSM internal pipe swivel/NPTF external pipe

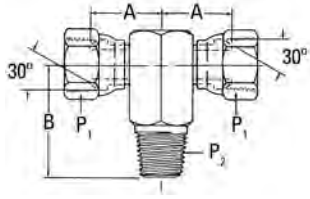

2254-(Dash size)
(Formerly Weatherhead series 9406x)

Dash size	Threads P1	Thread P2	A		B	
			mm	in	mm	in
2-2S	1/8-27	1/8-27	17,8	0.7	18,3	0.72
4-4S	1/4-18	1/4-18	22,4	0.88	27,7	1.09
4-6S	1/4-18	3/8-18	25,1	0.99	31,0	1.22
4-8S	1/4-18	1/2-14	25,9	1.02	37,3	1.47
6-6S	3/8-18	3/8-18	27,7	1.09	38,9	1.53
6-8S	3/8-18	1/2-14	27,7	1.09	37,3	1.47
8-8S	1/2-14	1/2-14	27,9	1.10	37,3	1.47
12-12S	3/4-14	3/4-14	34,5	1.36	51,6	2.03

NPSM internal pipe swivel

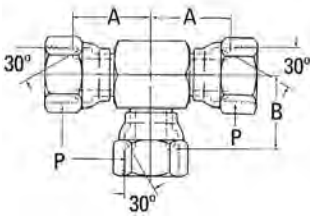

2255-(Dash size)
(Formerly Weatherhead series 9705x)

Dash size	Threads P1	A		B	
		mm	in	mm	in
2-2S	1/8-27	18,0	0.71	18,0	0.71
4-4S	1/4-18	23,1	0.91	23,1	0.91
6-6S	3/8-18	25,1	0.99	25,1	0.99
8-8S	1/2-14	27,4	1.08	27,4	1.08
12-12S	3/4-14	34,5	1.36	34,5	1.36

NPSM internal pipe swivel/ NPTF internal pipe

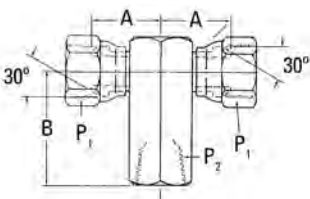

2253-(Dash size)
(Formerly Weatherhead series 9456x)

Dash size	Threads P1	Thread P2	A		B	
			mm	in	mm	in
6-6S	3/8-18	3/8-18	26,9	1.06	25,9	1.02
8-8S	1/2-14	1/2-14	31,5	1.24	31,2	1.23
12-12S	3/4-14	3/4-14	36,5	1.44	34,5	1.36

Steel adapters

Pipe to pipe

J

Pipe to pipe

NPTF external pipe/ NPTF internal pipe

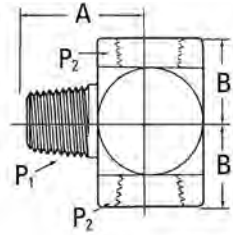

2091-(Dash size) (Ref. SAE 140425)
(Formerly Weatherhead series C3609x)

Dash size	Threads P1	Thread P2	A		B	
			mm	in	mm	in
2-2S	1/8-27	1/8-27	19,8	0.78	16,8	0.66
4-4S*	1/4-18	1/4-18	27,7	1.09	22,4	0.88
6-6S	3/8-18	3/8-18	31,0	1.22	25,9	1.02
8-8S	1/2-14	1/2-14	37,3	1.47	31,2	1.23
12-12S	3/4-14	3/4-14	40,4	1.59	34,5	1.36
16-16S	1-11 1/2	1-11 1/2	50,0	1.97	41,1	1.62

* Also available in stainless steel as part number 259-2091-(dash size).

NPTF internal pipe/NPTF internal pipe

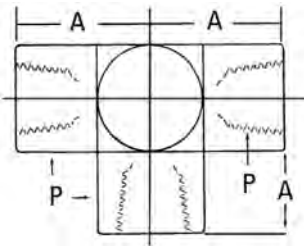

2090-(Dash size) (Ref. SAE 140438)
(Formerly Weatherhead series C3709x)

Dash size	Threads P1	A	
		mm	in
2-2S	1/8-27	16,8	0.66
4-4S	1/4-18	22,4	0.88
6-6S	3/8-18	25,9	1.02
8-8S	1/2-14	31,2	1.23
12-12S	3/4-14	34,5	1.36
16-16S	1-11 1/2	41,1	1.62
20-20S	1 1/4-11 1/2	43,2	1.70
24-24S	1 1/2-11 1/2	52,8	2.08

NPTF internal pipe/NPTF internal pipe

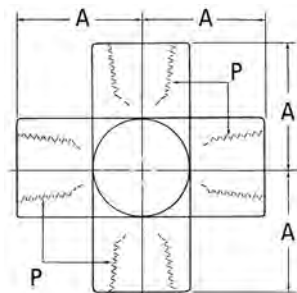

2080-(Dash size)
(Formerly Weatherhead series C3959x)

Dash size	Threads P1	A	
		mm	in
2-2S	1/8-27	16,8	0.66
4-4S	1/4-18	22,3	0.88
6-6S	3/8-18	25,9	1.02
8-8S	1/2-14	31,2	1.23
12-12S	3/4-14	34,5	1.36
16-16S	1-11 1/2	41,1	1.62

Pipe to SAE 37° flare

NPTF external pipe/SAE 37° flare

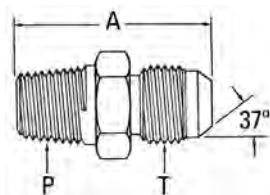

2021-(Dash size) (Ref. SAE 070102)
(Formerly Weatherhead series C5205x)

Dash size	Tube O. D.		Thread P	Thread T	A	
	mm	in			mm	in
2-2S	3,3	0.13	1/8-27	5/16-24	28,2	1.11
2-3S	4,8	0.19	1/8-27	3/8-24	29,0	1.14
2-4S*	6,3	0.25	1/8-27	7/16-20	31,0	1.22
2-5S	7,9	0.31	1/8-27	1/2-20	31,0	1.22
2-6S	9,6	0.38	1/8-27	9/16-18	31,5	1.24
2-8S	12,7	0.50	1/8-27	3/4-16	34,0	1.34
4-4S*	6,3	0.25	1/4-18	7/16-20	36,1	1.42
4-5S*	7,9	0.31	1/4-18	1/2-20	36,1	1.42
4-6S*	9,6	0.38	1/4-18	9/16-18	36,3	1.43
4-8S*	12,7	0.50	1/4-18	3/4-16	38,9	1.53
6-4S*	6,3	0.25	3/8-18	7/16-20	36,1	1.42
6-5S	7,9	0.31	3/8-18	1/2-20	36,1	1.42
6-6S*	9,6	0.38	3/8-18	9/16-18	36,3	1.43
6-8S*	12,7	0.50	3/8-18	3/4-16	38,9	1.53
6-10S*	16,0	0.63	3/8-18	7/8-14	43,2	1.70
6-12S	19,0	0.75	3/8-18	1 1/16-12	44,5	1.75
8-4S	6,3	0.25	1/2-14	7/16-20	42,7	1.68
8-6S*	9,6	0.38	1/2-14	9/16-18	42,9	1.69
8-8S*	12,7	0.50	1/2-14	3/4-16	45,5	1.79
8-10S*	16,0	0.63	1/2-14	7/8-14	48,0	1.89
8-12S*	19,0	0.75	1/2-14	1 1/16-12	52,3	2.06
8-16S	25,4	1.00	1/2-14	1 5/16-12	53,6	2.11
12-6S	9,6	0.38	3/4-14	9/16-18	44,5	1.75
12-8S*	12,7	0.50	3/4-14	3/4-16	47,0	1.85
12-10S*	16,0	0.63	3/4-14	7/8-14	49,5	1.95
12-12S*	19,0	0.75	3/4-14	1 1/16-12	52,3	2.06
12-14S	22,3	0.88	3/4-14	1 3/16-12	53,1	2.09
12-16S*	25,4	1.00	3/4-14	1 5/16-12	53,6	2.11
16-10S	16,0	0.63	1-11 1/2	7/8-14	54,6	2.15
16-12S	19,0	0.75	1-11 1/2	1 1/16-12	57,2	2.25
16-16S*	25,4	1.00	1-11 1/2	1 5/16-12	58,4	2.30
16-20S	31,7	1.25	1-11 1/2	1 5/8-12	61,5	2.42
16-24S	38,1	1.50	1-11 1/2	1 7/8-12	66,5	2.62
16-32S	50,8	2.00	1-11 1/2	2 1/2-12	76,7	3.02
20-12S	19,0	0.75	1 1/4-11 1/2	1 1/16-12	59,9	2.36
20-16S*	25,4	1.00	1 1/4-11 1/2	1 5/16-12	61,0	2.40
20-20S*	31,7	1.25	1 1/4-11 1/2	1 5/8-12	62,2	2.45
20-24S*	38,1	1.50	1 1/4-11 1/2	1 7/8-12	67,3	2.65
20-32S	50,8	2.00	1 1/4-11 1/2	2 1/2-12	77,5	3.05
24-12S	19,0	0.75	1 1/2-11 1/2	1 1/16-12	62,5	2.46
24-16S	25,4	1.00	1 1/2-11 1/2	1 5/16-12	63,8	2.51
24-20S	31,7	1.25	1 1/2-11 1/2	1 5/8-12	64,8	2.55
24-24S*	38,1	1.50	1 1/2-11 1/2	1 7/8-12	68,1	2.68
24-32S	50,8	2.00	1 1/2-11 1/2	2 1/2-12	78,2	3.08
32-32S*	50,8	2.00	2-11 1/2	2 1/2-12	79,0	3.11
40-40S	63,5	2.50	2 1/2-8	3-12	85,9	3.38

* Also available in stainless steel as part number 259-2021-(dash size).
(Formerly Weatherhead 5217x).

Steel adapters

Pipe to SAE 37° flare

J

Pipe to SAE 37° flare

NPTF external pipe/SAE 37° flare bulkhead

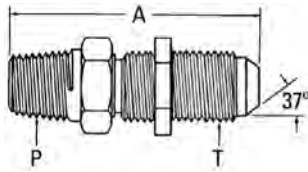

2240-(Dash size)

Dash size	Tube O. D.		Thread P	Thread T	A	
	mm	in			mm	in
2-4S	6,3	0.25	1/8-27	7/16-20	46,7	1.84
4-4S	6,3	0.25	1/4-18	7/16-20	51,6	2.03
4-6S	9,6	0.38	1/4-18	9/16-18	53,8	2.12
6-8S	12,7	0.50	3/8-18	3/4-16	59,9	2.36
8-10S	16,0	0.63	1/2-14	7/8-14	68,8	2.71
12-12S	19,0	0.75	3/4-14	1 1/16-12	74,2	2.92
16-16S	25,4	1.00	1-11 1/2	1 5/16-12	79,0	3.11

Note: Also available in stainless steel as 259-2240-(dash size).

NPTF external pipe/SAE 37° flare

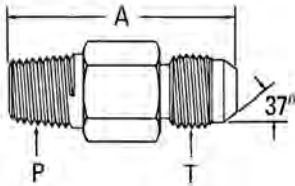

202113-(Dash size)

Dash size	Tube O. D.		Thread P	Thread T	A	
	mm	in			mm	in
2-4S	6,3	0.25	1/8-27	7/16-20	46,0	1.81
2-5S	7,9	0.31	1/8-27	1/2-20	49,3	1.94
4-4S	6,3	0.25	1/4-18	7/16-20	57,2	2.25
4-5S	7,9	0.31	1/4-18	1/2-20	57,2	2.25
4-6S	9,6	0.38	1/4-18	9/16-18	57,2	2.25
6-6S	9,6	0.38	3/8-18	9/16-18	63,5	2.50
6-8S	12,7	0.50	3/8-18	3/4-16	69,8	2.75
8-8S	12,7	0.50	1/2-14	3/4-16	70,9	2.79
8-10S	16,0	0.63	1/2-14	7/8-14	79,2	3.12
8-12S	19,0	0.75	1/2-14	11/16-12	83,3	3.28
12-12S	19,0	0.75	3/4-14	11/16-12	88,9	3.50
16-16S	25,4	1.00	1-11 1/2	15/16-12	101,6	4.00
20-20S	38,1	1.50	1 1/4-11 1/2	1 5/8-12	114,3	4.50
24-24S	38,1	1.50	1 1/2-11 1/2	1 7/8-12	123,9	4.88
32-32S	50,8	2.00	2-11 1/2	2 1/2-12	142,7	5.62

NPTF external pipe/SAE 37° flare

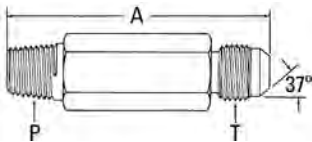

202114-(Dash size)

Dash size	Tube O. D.		Thread P	Thread T	A	
	mm	in			mm	in
2-4S	6,3	0.25	1/8-27	7/16-20	65,0	2.56
4-4S	6,3	0.25	1/4-18	7/16-20	82,5	3.25
4-5S	7,9	0.31	1/4-18	1/2-20	82,5	3.25
4-6S	9,6	0.38	1/4-18	9/16-18	82,5	3.25
6-8S	12,7	0.50	3/8-18	3/4-16	101,6	4.00
8-6S	9,6	0.38	1/2-14	9/16-18	105,9	4.17
8-10S	16,0	0.63	1/2-14	7/8-14	111,2	4.38
12-12S	19,0	0.75	3/4-14	1 1/16-12	127,0	5.00
12-16S	25,4	1.00	3/4-14	1 5/16-12	141,2	5.56
16-16S	25,4	1.00	1-11 1/2	1 5/16-12	146,0	5.75

Pipe to SAE 37° flare

NPTF internal pipe/SAE 37° flare bulkhead

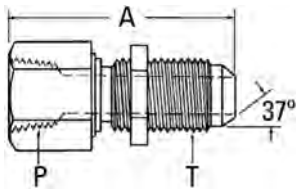

2239-(Dash size) (Ref. SAE 070603)
(Formerly Weatherhead series C5275x)

Dash size	Tube O. D.		Thread P	Thread T	A	
	mm	in			mm	in
2-4S	6,3	0.25	1/8-27	7/16-20	52,8	2.08
4-6S	9,6	0.38	1/4-18	9/16-18	54,6	2.15
6-8S	12,7	0.50	3/8-18	3/4-16	63,0	2.48
8-10S	16,0	0.63	1/2-14	7/8-14	72,1	2.84
12-12S	19,0	0.75	3/4-14	1 1/16-12	77,5	3.05
16-16S	25,4	1.00	1-11 1/2	1 5/16-12	82,6	3.25

Note: Available without nut. Order by part number 2239-1-(dash size).

NPTF external pipe/ SAE 37° flare swivel

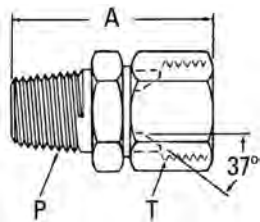

2018-(Dash size)
(Formerly Weatherhead series 9100x)

Dash size	Tube O. D.		Thread P	Thread T	A	
	mm	in			mm	in
2-4S	6,3	0.25	1/8-27	7/16-20	33,6	1.32
4-4S	6,3	0.25	1/4-18	7/16-20	38,1	1.50
4-5S	7,9	0.31	1/4-18	1/2-20	39,4	1.55
4-6S	9,6	0.38	1/4-18	9/16-18	40,4	1.59
6-6S	9,6	0.38	3/8-18	9/16-18	40,4	1.59
6-8S	12,7	0.50	3/8-18	3/4-16	44,2	1.74
6-10S	16,0	0.63	3/8-18	7/8-14	48,8	1.92
8-8S	12,7	0.50	1/2-14	3/4-16	49,0	1.93
8-10S	16,0	0.63	1/2-14	7/8-14	53,8	2.12
8-12S	19,0	0.75	1/2-14	1 1/16-12	56,4	2.22
12-12S	19,0	0.75	3/4-14	1 1/16-12	54,6	2.15
12-16S	25,4	1.00	3/4-14	1 5/16-12	59,6	2.35
16-16S	25,4	1.00	1-11 1/2	1 5/16-12	64,5	2.54
20-20S	31,7	1.25	1 1/4-11 1/2	1 5/8-12	70,6	2.78

NPTF internal pipe/ SAE 37° flare swivel

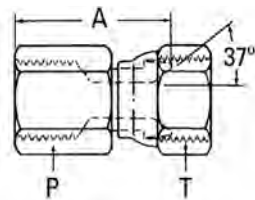

2242-(Dash size) (Ref. SAE 070603)
(Formerly Weatherhead series C5256x)

Dash size	Tube O. D.		Thread P	Thread T	A	
	mm	in			mm	in
2-4S	6,3	0.25	1/8-27	7/16-20	21,6	0.85
2-5S	7,9	0.31	1/8-27	1/2-20	22,1	0.87
4-4S	6,3	0.25	1/4-18	7/16-20	28,2	1.11
4-5S	7,9	0.31	1/4-18	1/2-20	27,9	1.10
4-6S	9,6	0.38	1/4-18	9/16-18	30,0	1.18
6-6S	9,6	0.38	3/8-18	9/16-18	29,5	1.16
6-8S	12,7	0.50	3/8-18	3/4-16	30,5	1.20
8-6S	9,6	0.38	1/2-14	9/16-18	36,1	1.42
8-8S	12,7	0.50	1/2-14	3/4-16	37,6	1.48
8-10S	16,0	0.63	1/2-14	7/8-14	37,3	1.47
8-12S	19,0	0.75	1/2-14	1 1/16-12	36,8	1.45
12-12S	19,0	0.75	3/4-14	1 1/16-12	37,8	1.49
12-14S	22,3	0.88	3/4-14	1 3/16-12	39,4	1.55
16-16S	25,4	1.00	1-11 1/2	1 5/16-12	47,0	1.85
20-20S	31,7	1.25	1 1/4-11 1/2	1 5/8-12	51,3	2.02

Steel adapters

Pipe to SAE 37° flare

J

Pipe to SAE 37° flare

NPTF internal pipe/SAE 37° flare

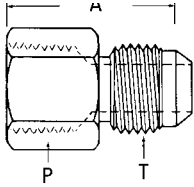

2022-(Dash size) (Ref. SAE 070103)
(Formerly Weatherhead series C5255x)

Dash size	Tube O. D.		Thread P	Thread T	A	
	mm	in			mm	in
2-2S	4,8	0.13	1/8-27	5/16-24	28,4	1.12
2-3S	4,8	0.19	1/8-27	3/8-24	28,7	1.13
2-4S	6,4	0.25	1/8-27	7/16-20	30,2	1.19
2-5S	7,9	0.31	1/8-27	1/2-20	29,7	1.17
4-3S	4,8	0.19	1/4-18	3/8-24	33,5	1.32
4-4S*	6,4	0.25	1/4-18	7/16-20	35,3	1.39
4-5S	7,9	0.31	1/4-18	1/2-20	35,3	1.39
4-6S	9,7	0.38	1/4-18	9/16-18	35,6	1.40
4-8S	12,7	0.50	1/4-18	3/4-16	39,4	1.55
6-6S*	9,7	0.38	3/8-18	9/16-18	37,1	1.46
6-8S*	12,7	0.50	3/8-18	3/4-16	39,6	1.56
6-10S	16,0	0.63	3/8-18	7/8-14	42,9	1.69
8-4S	6,4	0.25	1/2-14	7/16-20	42,7	1.68
8-6S	9,7	0.38	1/2-14	9/16-18	42,9	1.69
8-8S*	12,7	0.50	1/2-14	3/4-16	45,5	1.79
8-10S	16,0	0.63	1/2-14	7/8-14	48,0	1.89
8-12S	19,1	0.75	1/2-14	1 1/16-12	52,1	2.05
12-8S	12,7	0.50	3/4-14	3/4-16	47,0	1.85
12-10S	16,0	0.63	3/4-14	7/8-14	49,5	1.95
12-12S	19,1	0.75	3/4-14	1 1/16-12	52,3	2.06
12-16S	25,4	1.00	3/4-14	1 5/16-12	53,8	2.12
16-12S	19,1	0.75	1-11 1/2	1 1/16-12	58,4	2.30
16-16S	25,4	1.00	1-11 1/2	1 5/16-12	59,7	2.35
20-16S	25,4	1.00	1 1/4-11 1/2	1 5/16-12	62,0	2.44
20-20S	31,8	1.25	1 1/4-11 1/2	1 5/8-12	63,2	2.49
24-24S	38,1	1.50	1 1/2-11 1/2	1 7/8-12	66,5	2.62
32-32S	50,8	2.00	2-11 1/2	2-11 1/2	75,4	2.97

* Also available in stainless steel as part number 259-2022-(dash size).
(Formerly Weatherhead 5267x)

NPTF internal pipe/SAE 37° flare

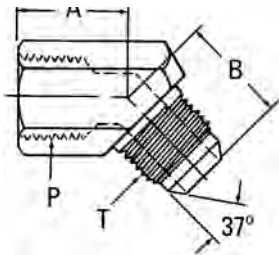

2044-(Dash size)

Dash size	Tube O. D.		Thread P	Thread T	A		B	
	mm	in			mm	in	mm	in
4-6S	9,6	0.38	1/4-18	9/16-18	15,7	0.62	21,0	0.83
6-8S	12,7	0.50	3/8-18	3/4-16	18,3	0.72	24,9	0.98
8-10S	16,0	0.63	1/2-14	7/8-14	23,1	0.91	28,2	1.11
12-12S	19,0	0.75	3/4-14	1 1/16-12	24,6	0.97	34,3	1.35

Pipe to SAE 37° flare

NPTF external pipe/SAE 37° flare

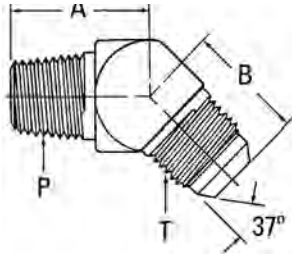

2023-(Dash size) (Ref. SAE 070302)
(Formerly Weatherhead series C5355x)

Dash size	Tube O. D.		Thread P	Thread T	A		B	
	mm	in			mm	in	mm	in
2-3S	4,8	0.19	1/8-27	3/8--24	18,3	0.72	21,1	0.83
2-4S	6,3	0.25	1/8-27	7/16-20	16,3	0.64	18,3	0.72
2-5S	7,9	0.31	1/8-27	1/2-20	16,3	0.64	19,6	0.77
2-6S	9,6	0.38	1/8-27	9/16-18	17,0	0.67	21,1	0.83
4-4S	6,3	0.25	1/4-18	7/16-20	21,8	0.86	20,8	0.82
4-5S	7,9	0.31	1/4-18	1/2-20	21,8	0.86	20,8	0.82
4-6S*	9,6	0.38	1/4-18	9/16-18	21,8	0.86	21,1	0.83
4-8S	12,7	0.50	1/4-18	3/4-16	24,1	0.95	24,9	0.98
6-4S	6,3	0.25	3/8-18	7/16-20	24,1	0.95	21,6	0.85
6-6S	9,6	0.38	3/8-18	9/16-18	24,1	0.95	22,1	0.87
6-8S	12,7	0.50	3/8-18	3/4-16	24,1	0.95	24,9	0.98
6-10S	16,0	0.63	3/8-18	7/8-14	24,9	0.98	28,2	1.11
6-12S	19,0	0.75	3/8-18	1 1/16-12	25,7	1.01	32,5	1.28
8-6S	9,6	0.38	1/2-14	9/16-18	29,7	1.17	22,4	0.88
8-8S	12,7	0.50	1/2-14	3/4-16	29,7	1.17	25,1	0.99
8-10S	16,0	0.63	1/2-14	7/8-14	29,7	1.17	28,2	1.11
8-12S	19,0	0.75	1/2-14	1 1/16-12	30,5	1.20	32,5	1.28
12-8S	12,7	0.50	3/4-14	3/4-16	30,5	1.20	26,4	1.04
12-10S	16,0	0.63	3/4-14	7/8-14	30,5	1.20	29,5	1.16
12-12S	19,0	0.75	3/4-14	1 1/16-12	30,5	1.20	32,5	1.28
12-16S	25,4	1.00	3/4-14	1 5/16-12	32,8	1.29	37,3	1.47
16-12S	19,0	0.75	1-11 1/2	1 1/16-12	37,6	1.48	36,1	1.42
16-16S	25,4	1.00	1-11 1/2	1 5/16-12	37,6	1.48	37,3	1.47
16-20S	31,7	1.25	1-11 1/2	1 5/8-12	41,7	1.64	40,4	1.59
20-20S	31,7	1.25	1 1/4-11 1/2	1 5/8-12	42,4	1.67	40,4	1.59
24-24S	38,1	1.50	1 1/2-11 1/2	1 7/8-12	45,0	1.77	45,2	1.78
32-32S	50,8	2.00	2-11 1/2	2 1/2-12	53,6	2.11	56,4	2.22

* Also available in stainless steel as part number 259-2023-(dash size).
(Formerly Weatherhead 5367x)

NPTF internal pipe/SAE 37° flare swivel

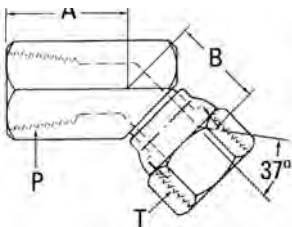

2243-(Dash size)

Dash size	Tube O. D.		Thread P	Thread T	A		B	
	mm	in			mm	in	mm	in
8-6S	9,6	0.38	1/2-14	9/16-18	23,1	0.91	21,3	0.84
8-10S	16,0	0.63	1/2-14	7/8-14	23,1	0.91	23,9	0.94

Steel adapters

Pipe to SAE 37° flare

J

Pipe to SAE 37° flare

NPTF external pipe/SAE 37° flare

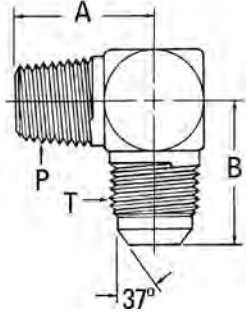

2024-(Dash size) (Ref. SAE 070202)
(Formerly Weatherhead series C5405x)

Dash size	Tube O. D.		Thread P	Thread T	A		B	
	mm	in			mm	in	mm	in
2-3S	4,8	0.19	1/8-27	3/8-24	18,3	0.72	21,1	0.83
2-4S*	6,3	0.25	1/8-27	7/16-20	19,8	0.78	22,6	0.89
2-5S	7,9	0.31	1/8-27	1/2-20	19,8	0.78	24,1	0.95
2-6S	9,6	0.38	1/8-27	9/16-18	22,9	0.90	26,9	1.06
4-4S*	6,3	0.25	1/4-18	7/16-20	27,7	1.09	26,7	1.05
4-5S	7,9	0.31	1/4-18	1/2-20	27,7	1.09	26,7	1.05
4-6S*	9,6	0.38	1/4-18	9/16-18	27,7	1.09	26,9	1.06
4-8S	12,7	0.50	1/4-18	3/4-16	31,0	1.22	31,8	1.25
6-4S	6,3	0.25	3/8-18	7/16-20	31,0	1.22	28,4	1.12
6-5S	7,9	0.31	3/8-18	1/2-20	31,0	1.22	28,4	1.12
6-6S	9,6	0.38	3/8-18	9/16-18	31,0	1.22	29,0	1.14
6-8S	12,7	0.50	3/8-18	3/4-16	31,0	1.22	31,8	1.25
6-10S	16,0	0.63	3/8-18	7/8-14	32,5	1.28	36,8	1.45
6-12S	19,0	0.75	3/8-18	1 1/16-12	35,6	1.40	42,2	1.66
8-4S	6,3	0.25	1/2-14	7/16-20	37,3	1.47	30,7	1.21
8-6S	9,6	0.38	1/2-14	9/16-18	37,3	1.47	31,0	1.22
8-8S*	12,7	0.50	1/2-14	3/4-16	37,3	1.47	33,8	1.33
8-10S	16,0	0.63	1/2-14	7/8-14	37,3	1.47	36,8	1.45
8-12S	19,0	0.75	1/2-14	1 1/16-12	40,4	1.59	42,2	1.66
8-16S	25,4	1.00	1/2-14	1 5/16-12	45,2	1.78	46,0	1.81
12-6S	9,6	0.38	3/4-14	9/16-18	40,4	1.59	33,3	1.31
12-8S	12,7	0.50	3/4-14	3/4-16	40,4	1.59	36,1	1.42
12-10S	16,0	0.63	3/4-14	7/8-14	40,4	1.59	39,1	1.54
12-12S	19,0	0.75	3/4-14	1 1/16-12	40,4	1.59	42,2	1.66
12-16S	25,4	1.00	3/4-14	1 5/16-12	45,2	1.78	46,0	1.81
16-8S	12,7	0.50	1-11 1/2	3/4-16	50,0	1.97	38,6	1.52
16-12S	19,0	0.75	1-11 1/2	1 1/16-12	50,0	1.97	44,7	1.76
16-16S	25,4	1.00	1-11 1/2	1 5/16-12	50,0	1.97	46,0	1.81
16-20S	31,7	1.25	1-11 1/2	1 5/8-12	59,7	2.35	52,3	2.06
20-16S	25,4	1.00	1 1/4-11 1/2	1 5/16-12	60,5	2.38	51,1	2.01
20-20S	31,7	1.25	1 1/4-11 1/2	1 5/8-12	60,5	2.38	52,3	2.06
20-24S	38,1	1.50	1 1/4-11 1/2	1 7/8-12	66,3	2.61	59,2	2.33
24-20S	31,7	1.25	1 1/2-11 1/2	1 5/8-12	67,1	2.64	55,9	2.20
24-24S	38,1	1.50	1 1/2-11 1/2	1 7/8-12	67,1	2.64	59,2	2.33
24-32S	50,8	2.00	1 1/2-11 1/2	2 1/2-12	75,4	2.97	77,7	3.06
32-32S	50,8	2.00	2-11 1/2	2 1/2-12	76,2	3.00	77,7	3.06

* Also available in stainless steel as part number 259-2024-(dash size)
(Formerly Weatherhead 5417x)

Pipe to SAE 37° flare

Extra pipe/SAE 37° flare

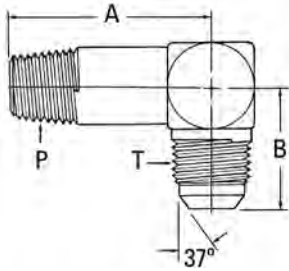

202411-(Dash size) (Ref. SAE 071502)
(Formerly Weatherhead series C5425x)

Dash size	Tube O. D.		Thread P	Thread T	A		B	
	mm	in			mm	in	mm	in
2-4S	6,3	0.25	1/8-27	7/16-20	29,7	1.17	22,6	0.89
2-5S	7,9	0.31	1/8-27	1/2-20	29,7	1.17	24,1	0.95
4-4S	6,3	0.25	1/4-18	7/16-20	40,1	1.58	26,7	1.05
4-6S	9,6	0.38	1/4-18	9/16-18	40,1	1.58	26,9	1.06
4-8S	12,7	0.50	1/4-18	3/4-16	46,2	1.82	31,8	1.25
6-6S	9,6	0.38	3/8-18	9/16-18	46,2	1.82	29,0	1.14
6-8S	12,7	0.50	3/8-18	3/4-16	46,2	1.82	31,8	1.25
8-8S	12,7	0.50	1/2-14	3/4-16	55,1	2.17	33,8	1.33
8-10S	16,0	0.63	1/2-14	7/8-14	55,1	2.17	36,8	1.45
12-10S	16,0	0.63	3/4-14	7/8-14	62,0	2.44	39,1	1.54
12-12S	19,0	0.75	3/4-14	1 1/16-12	62,0	2.44	42,2	1.66
12-16S	25,4	1.00	3/4-14	1 5/16-12	71,6	2.82	46,0	1.81
16-16S	25,4	1.00	1-11 1/2	1 5/16-12	76,5	3.01	46,0	1.81
20-20S	31,70	1.25	1 1/4-11 1/2	1 5/8-12	93,7	3.69	52,3	2.06

Long NPTF external pipe/SAE 37° flare

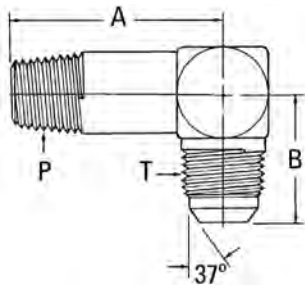

202413-(Dash size) (Ref. SAE 071602)
(Formerly Weatherhead series C5435x)

Dash size	Tube O. D.		Thread P	Thread T	A		B	
	mm	in			mm	in	mm	in
2-4S	6,3	0.25	1/8-27	7/16-20	39,6	1.56	22,6	0.89
2-5S	7,9	0.31	1/8-27	1/2-20	41,4	1.63	24,1	0.95
4-4S	6,3	0.25	1/4-18	7/16-20	52,6	2.07	26,7	1.05
4-5S	7,9	0.31	1/4-18	1/2-20	52,6	2.07	26,7	1.05
4-6S	9,6	0.38	1/4-18	9/16-18	52,6	2.07	26,9	1.06
6-6S	9,6	0.38	3/8-18	9/16-18	61,5	2.42	29,0	1.14
6-8S	12,7	0.50	3/8-18	3/4-16	61,5	2.42	31,8	1.25
8-8S	12,7	0.50	1/2-14	3/4-16	72,9	2.87	33,8	1.33
8-10S	16,0	0.63	1/2-14	7/8-14	72,9	2.87	36,8	1.45
8-12S	19,0	0.75	1/2-14	1 1/16-12	83,3	3.28	42,2	1.66
12-12S	19,0	0.75	3/4-14	1 1/16-12	83,3	3.28	42,2	1.66
12-16S	25,4	1.00	3/4-14	1 5/16-12	98,0	3.86	46,0	1.81
16-16S	25,4	1.00	1-11 1/2	1 5/16-12	102,9	4.05	46,0	1.81
20-20S	31,7	1.25	1 1/4-11 1/2	1 5/8-12	122,9	4.84	52,3	2.06

Steel adapters

Pipe to SAE 37° flare

J

Pipe to SAE 37° flare

Extra long NPTF external pipe/SAE 37° flare

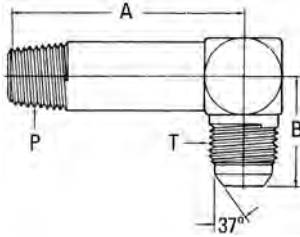

202414-(Dash size)

Dash size	Tube O. D.		Thread P	Thread T	A		B	
	mm	in			mm	in	mm	in
2-4S	6,3	0.25	1/8-27	7/16-20	58,7	2.31	22,6	0.89
4-4S	6,3	0.25	1/4-18	7/16-20	75,9	2.99	24,6	0.97
4-6S	9,6	0.38	3/8-18	9/16-18	77,7	3.06	26,9	1.06
8-10S	16,0	0.63	1/2-14	7/8-14	114,5	4.51	36,8	1.45

NPTF external pipe/SAE 37° flare swivel

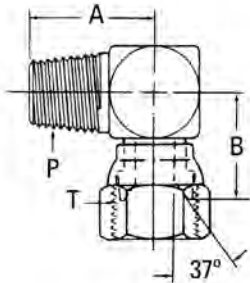

2250-(Dash size)

(Formerly Weatherhead series C5406x)

Dash size	Tube O. D.		Thread P	Thread T	A		B	
	mm	in			mm	in	mm	in
2-4S	6,3	0.25	1/8-27	7/16-20	19,8	0.78	16,8	0.66
2-5S	7,9	0.31	1/8-27	1/2-20	19,8	0.78	17,3	0.68
4-4S	6,3	0.25	1/4-18	7/16-20	27,7	1.09	20,8	0.82
4-6S	9,6	0.38	1/4-18	9/16-18	27,7	1.09	22,3	0.88
6-6S	9,6	0.38	3/8-18	9/16-18	31,0	1.22	21,6	0.85
6-8S	12,7	0.50	3/8-18	3/4-16	31,0	1.22	24,4	0.96
8-8S	12,7	0.50	1/2-14	3/4-16	37,3	1.47	25,4	1.00
8-10S	16,0	0.63	1/2-14	7/8-14	37,3	1.47	28,5	1.12
12-8S	12,7	0.50	3/4-14	3/4-16	40,4	1.59	29,7	1.17
12-12S	19,0	0.75	3/4-14	1 1/16-12	40,4	1.59	30,3	1.19
12-14S	22,3	0.88	3/4-14	1 3/16-12	42,9	1.69	30,5	1.20
16-16S	25,4	1.00	1-11 1/2	1 5/16-12	50,0	1.97	35,8	1.41
20-20S	31,7	1.25	1 1/4-11 1/2	1 5/8-12	60,4	2.38	42,7	1.68
24-24S	38,1	1.50	1 1/2-11 1/2	1 7/8-12	67,0	2.64	47,2	1.86
32-32S	50,8	2.00	2-11 1/2	2 1/2-12	76,2	3.00	62,0	2.44

NPTF external pipe swivel/SAE 37° flare

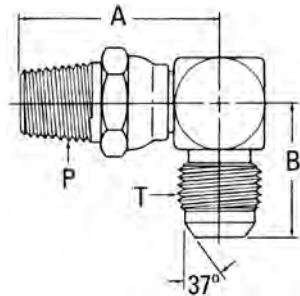

2249-(Dash size)

Dash size	Tube O. D.		Thread P	Thread T	A		B	
	mm	in			mm	in	mm	in
4-6S	9,6	0.38	1/4-18	9/16-18	40,6	1.60	26,9	1.06
6-8S	12,7	0.50	3/8-18	3/4-16	43,4	1.71	31,0	1.22
8-10S	16,0	0.63	1/2-14	7/8-14	50,8	2.00	36,8	1.45
12-12S	19,0	0.75	3/4-14	1 1/16-12	41,1	1.62	42,2	1.66

Note: The above adapter is not a rotating union or swivel joint. Care must be exercised to avoid misuse. To be used with petroleum or water glycol fluids.

Pipe to SAE 37° flare

NPTF internal pipe/SAE 37° flare swivel

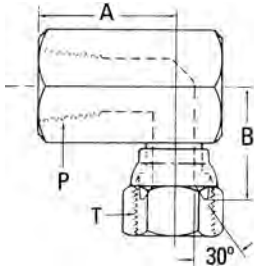

2244-(Dash size)

Dash size	Tube O. D.		Thread P	Thread T	A		B	
	mm	in			mm	in	mm	in
6-6S	9,6	0.38	3/8-18	9/16-18	25,9	1.02	23,4	0.92
8-8S	12,7	0.50	1/2-14	3/4-16	31,2	1.23	27,4	1.08
8-10S	16,0	0.63	1/2-14	7/8-14	31,2	1.23	28,5	1.12

NPTF internal pipe/SAE 37° flare

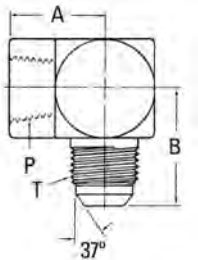

2025-(Dash size) (Ref. SAE 070203) (Formerly Weatherhead series C5455x)

Dash size	Tube O. D.		Thread P	Thread T	A		B	
	mm	in			mm	in	mm	in
2-4S	6,3	0.25	1/8-27	7/16-20	16,8	0.66	27,4	1.08
2-5S	7,9	0.31	1/8-27	1/2-20	16,8	0.66	27,4	1.08
2-6S	9,6	0.38	1/8-27	9/16-18	17,0	0.67	31,2	1.23
4-4S	6,3	0.25	1/4-18	7/16-20	22,4	0.88	31,0	1.22
4-5S	7,9	0.31	1/4-18	1/2-20	22,4	0.88	31,0	1.22
4-6S	9,6	0.38	1/4-18	9/16-18	22,4	0.88	31,2	1.23
4-8S	12,7	0.50	1/4-18	3/4-16	25,7	1.01	36,1	1.42
6-4S	6,3	0.25	3/8-18	7/16-20	25,9	1.02	32,8	1.29
6-5S	7,9	0.31	3/8-18	1/2-20	25,9	1.02	32,8	1.29
6-6S	9,6	0.38	3/8-18	9/16-18	25,9	1.02	33,3	1.31
6-8S	12,7	0.50	3/8-18	3/4-16	25,9	1.02	36,1	1.42
8-4S	6,3	0.25	1/2-14	7/16-20	31,2	1.23	35,6	1.40
8-8S	12,7	0.50	1/2-14	3/4-16	31,2	1.23	38,6	1.52
8-10S	16,0	0.63	1/2-14	7/8-14	31,2	1.23	41,7	1.64
8-12S	19,0	0.75	1/2-14	1 1/16-12	34,3	1.35	48,0	1.89
12-12S	19,0	0.75	3/4-14	1 1/16-12	34,5	1.36	48,0	1.89
16-16S	25,4	1.00	1-11 1/2	1 5/16-12	41,1	1.62	55,1	2.17
20-20S	31,7	1.25	1 1/4-11 1/2	1 5/8-12	43,2	1.70	59,2	2.33
24-24S	38,1	1.50	1 1/2-11 1/2	1 7/8-12	52,8	2.08	73,4	2.89
32-32S	50,8	2.00	2-11 1/2	2 1/2-12	60,7	2.39	83,8	3.30

NPTF external pipe/SAE 37° flare

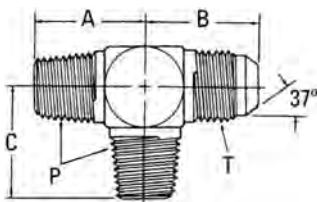

203007-(Dash size)

Dash size	Tube O. D.		Thread P	Thread T	A		B		C	
	mm	in			mm	in	mm	in		
2-4S	6,3	0.25	1/8-27	7/16-20	19,8	0.78	22,6	0.89	19,8	0.78
4-6S	9,6	0.38	1/4-18	9/16-18	27,7	1.09	26,9	1.06	27,7	1.09
6-8S	12,7	0.50	3/8-18	3/4-16	31,0	1.22	31,8	1.25	31,0	1.22
12-12S	19,0	0.75	3/4-14	1 1/16-12	40,4	1.59	42,2	1.66	40,4	1.59
16-16S	25,4	1.00	1-11 1/2	1 5/16-12	50,0	1.97	46,0	1.81	50,0	1.97

Steel adapters

Pipe to SAE 37° flare

J

Pipe to SAE 37° flare

NPTF external pipe/ NPTF internal pipe/SAE 37° flare

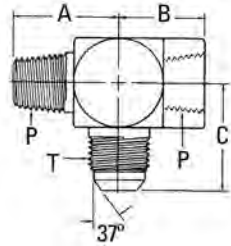

203301-(Dash size)

Dash size	Tube O. D.		Thread P	Thread T	A		B		C	
	mm	in			mm	in	mm	in	mm	in
2-4S	6,3	0.25	1/8-27	7/16-20	19,8	0.78	16,8	0.66	27,4	1.08
4-6S	9,6	0.38	1/4-18	9/16-18	27,7	1.09	22,3	0.88	31,2	1.23
6-8S	12,7	0.50	3/8-18	3/4-16	31,0	1.22	25,9	1.02	36,1	1.42
8-10S	16,0	0.63	1/2-14	7/8-14	37,3	1.47	31,2	1.23	41,6	1.64
12-12S	19,0	0.75	3/4-14	1 1/16-12	40,4	1.59	34,5	1.36	48,0	1.89
16-16S	25,4	1.00	1-11 1/2	1 5/16-12	50,0	1.97	41,1	1.62	55,2	2.17

NPTF external pipe/SAE 37° flare/NPTF internal pipe

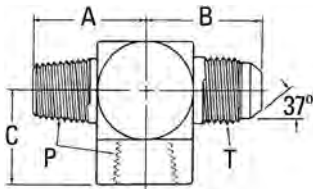

203103-(Dash size)

Dash size	Tube O. D.		Thread P	Thread T	A		B		C	
	mm	in			mm	in	mm	in	mm	in
2-4S	6,3	0.25	1/8-27	7/16-20	19,8	0.78	27,4	1.08	16,8	0.66
4-6S	9,6	0.38	1/4-18	9/16-18	27,7	1.09	31,2	1.23	22,3	0.88
6-6S	9,6	0.38	3/8-18	9/16-18	31,0	1.22	33,3	1.31	25,9	1.02
6-8S	12,7	0.50	3/8-18	3/4-16	31,0	1.22	36,1	1.42	25,9	1.02
8-10S	16,0	0.63	1/2-14	7/8-14	37,3	1.47	41,6	1.64	31,2	1.23
12-12S	19,0	0.75	3/4-14	1 1/16-12	40,4	1.59	48,0	1.89	34,5	1.36
16-16S	25,4	1.00	1-11 1/2	1 5/16-12	53,1	2.09	53,1	2.09	42,1	1.62

NPTF external pipe/SAE 37° flare

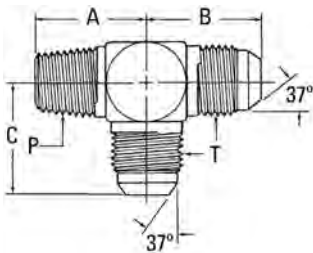

2028-(Dash size) (Ref. SAE 070424) (Formerly Weatherhead series C5755x)

Dash size	Tube O. D.		Thread P	Thread T	A		B		C	
	mm	in			mm	in	mm	in	mm	in
2-3S	4,8	0.19	1/8-27	3/8-24	18,3	0.72	21,1	0.83	21,1	0.83
2-4S	6,3	0.25	1/8-27	7/16-20	19,8	0.78	22,6	0.89	22,6	0.89
4-4S	6,3	0.25	1/4-18	7/16-20	27,7	1.09	26,7	1.05	26,7	1.05
4-5S	7,9	0.31	1/4-18	1/2-20	27,7	1.09	26,7	1.05	26,7	1.05
4-6S	9,6	0.38	1/4-18	9/16-18	27,7	1.09	26,9	1.06	26,9	1.06
6-6S	9,6	0.38	3/8-18	9/16-18	31,0	1.22	29,0	1.14	29,0	1.14
6-8S	12,7	0.50	3/8-18	3/4-16	31,0	1.22	31,8	1.25	31,8	1.25
8-8S	12,7	0.50	1/2-14	3/4-16	37,3	1.47	33,8	1.33	33,8	1.33
8-10S	16,0	0.63	1/2-14	7/8-14	37,3	1.47	36,8	1.45	36,8	1.45
8-12S	19,0	0.75	1/2-14	1 1/16-12	40,4	1.59	42,2	1.66	42,2	1.66
12-10S	16,0	0.63	3/4-14	7/8-14	40,4	1.59	39,1	1.54	39,1	1.54
12-12S	19,0	0.75	3/4-14	1 1/16-12	40,4	1.59	42,2	1.66	42,2	1.66
16-16S	25,4	1.00	1-11 1/2	1 5/16-12	50,0	1.97	46,0	1.81	46,0	1.81
20-20S	31,7	1.25	1 1/4-11 1/2	1 5/8-12	60,5	2.38	52,3	2.06	52,3	2.06
24-24S	38,1	1.50	1 1/2-11 1/2	1 7/8-12	67,1	2.64	59,2	2.33	59,2	2.33
32-32S	50,8	2.00	2-11 1/2	2 1/2-12	76,2	3.00	77,7	3.06	77,7	3.06

Pipe to SAE 37° flare

NPTF external pipe/ NPTF internal pipe/SAE 37° flare

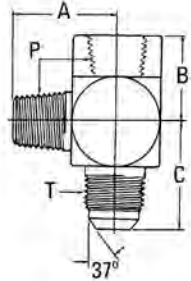

203006-(Dash size)

Dash size	Tube O. D.		Thread P	Thread T	A		B		C	
	mm	in			mm	in	mm	in	mm	in
4-6S	9,6	0.38	1/4-18	9/16-18	27,7	1.09	22,3	0.88	31,2	1.23
6-8S	12,7	0.50	3/8-18	3/4-16	31,0	1.22	25,9	1.02	36,1	1.42
8-10S	16,0	0.63	1/2-14	7/8-14	41,7	1.64	31,2	1.23	37,3	1.47
12-12S	19,0	0.75	3/4-14	1 1/16-12	40,4	1.59	34,5	1.36	48,0	1.89
16-16S	25,4	1.00	1-11 1/2	1 5/16-12	50,0	1.97	42,1	1.62	55,1	2.17
20-20S	31,7	1.25	1 1/4-11 1/2	1 5/8-12	59,2	2.33	43,2	1.70	60,5	2.38

NPTF external pipe/SAE 37° flare

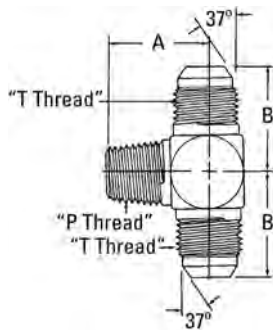

2030-(Dash size) (Ref. SAE 070425) (Formerly Weatherhead series C5605x)

Dash size	Tube O.D.		Thread P	Thread T	A		B	
	mm	in			mm	in	mm	in
2-4S	6,3	0.25	1/8-27	7/16-20	19,8	0.78	22,6	0.89
2-5S	7,9	0.31	1/8-27	1/2-20	19,8	0.78	24,1	0.95
4-4S	6,3	0.25	1/4-18	7/16-20	27,7	1.09	26,7	1.05
4-5S	7,9	0.31	1/4-18	1/2-20	27,7	1.09	26,7	1.05
4-6S	9,6	0.38	1/4-18	9/16-18	27,7	1.09	26,9	1.06
6-6S	9,6	0.38	3/8-18	9/16-18	31,0	1.22	29,0	1.14
6-8S	12,7	0.50	3/8-18	3/4-16	31,0	1.22	31,8	1.25
8-6S	9,6	0.38	1/2-14	9/16-18	37,3	1.47	31,0	1.22
8-8S	12,7	0.50	1/2-14	3/4-16	37,3	1.47	33,8	1.33
8-10S	16,0	0.63	1/2-14	7/8-14	37,3	1.47	36,8	1.45
12-12S	19,0	0.75	3/4-14	1 1/16-12	40,4	1.59	42,2	1.66
12-16S	25,4	1.00	3/4-14	1 5/16-12	45,2	1.78	46,0	1.81
16-16S	25,4	1.00	1-11 1/2	1 5/16-12	50,0	1.97	46,0	1.81
20-20S	31,7	1.25	1 1/4-11 1/2	1 5/8-12	60,5	2.38	52,3	2.06

NPTF internal pipe/SAE 37° flare

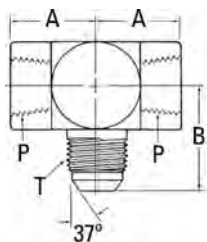

202901-(Dash size)

Dash size	Tube O.D.		Thread P	Thread T	A		B	
	mm	in			mm	in	mm	in
4-6S	9,6	0.38	1/4-18	9/16-18	22,3	0.88	31,2	1.23
12-12S	19,0	0.75	3/4-14	1 1/16-12	34,5	1.36	48,0	1.89
16-16S	25,4	1.00	1-11 1/2	1 5/16-12	42,1	1.62	55,1	2.17

NPTF internal pipe/ NPTF internal pipe/SAE 37° flare

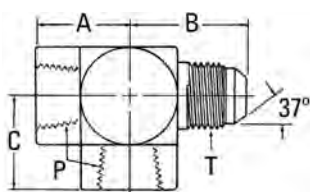

203104-(Dash size) (Ref. SAE 070427)

Dash size	Tube O.D.		Thread P	Thread T	A		B		C	
	mm	in			mm	in	mm	in	mm	in
4-6S	9,6	0.38	1/4-18	9/16-18	22,3	0.88	31,2	1.23	22,3	0.88
16-16S	25,4	1.00	1-11 1/2	1 5/16-12	42,1	1.62	55,1	2.17	42,1	1.62

Steel adapters

Pipe to SAE 37° flare

J

Pipe to SAE 37° flare

NPTF internal pipe/SAE 37° flare

2029-(Dash size) (Ref. SAE 070426)
(Formerly Weatherhead series C5805x)

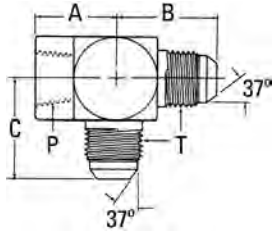

Dash size	Tube O.D.		Thread P	Thread T	A		B		C	
	mm	in			mm	in	mm	in	mm	in
2-4S	6,3	0.25	1/8-27	7/16-20	16,8	0.66	27,4	1.08	24,1	0.95
4-4S	6,3	0.25	1/4-18	7/16-20	22,4	0.88	25,4	1.00	25,4	1.00
4-6S	9,6	0.38	1/4-18	9/16-18	22,6	0.89	31,2	1.23	28,2	1.11
8-8S	12,7	0.50	1/2-14	3/4-16	31,2	1.23	36,1	1.42	35,6	1.40
12-12S	19,0	0.75	3/4-14	1 1/16-12	34,5	1.36	48,0	1.89	48,0	1.89
16-16S	25,4	1.00	1-11 1/2	1 5/16-12	41,1	1.62	55,2	2.17	53,1	2.09

NPTF internal pipe/ SAE 37° flare swivel

2031-(Dash size) (Ref. SAE 070427)
(Formerly Weatherhead series 5655x)

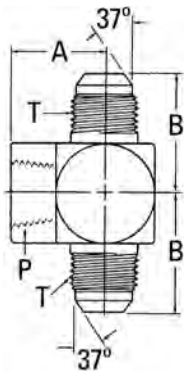

Dash size	Tube O.D.		Thread P	Thread T	A		B	
	mm	in			mm	in	mm	in
2-3S	4,8	0.19	1/8-27	3/8-24	16,8	0.66	26,2	1.03
2-4S	6,3	0.25	1/8-27	7/16-20	16,8	0.66	27,4	1.08
4-4S	6,3	0.25	1/4-18	7/16-20	22,4	0.88	31,0	1.22
4-6S	9,6	0.38	1/4-18	9/16-18	22,4	0.88	31,2	1.23
6-8S	12,7	0.50	3/8-18	3/4-16	25,9	1.02	36,1	1.42
8-8S	12,7	0.50	1/2-14	3/4-16	31,2	1.23	38,6	1.52
8-10S	16,0	0.63	1/2-14	7/8-14	31,2	1.23	41,6	1.64
12-12S	19,0	0.75	3/4-14	1 1/16-12	34,5	1.36	48,0	1.89
16-16S	25,4	1.00	1-11 1/2	1 5/16-12	41,1	1.62	53,1	2.09
32-32S	50,8	2.00	2-11 1/2	2 1/2-12	60,7	2.39	83,8	3.30

NPTF external pipe/SAE 37° flare

202003-(Dash size)

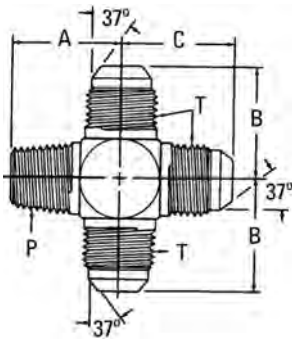

Dash size	Tube O.D.		Thread P	Thread T	A		B		C	
	mm	in			mm	in	mm	in	mm	in
6-6S	9,6	0.38	3/8-18	9/16-18	26,9	1.06	26,9	1.06	26,9	1.06

Pipe to 45° flare – Brass

NPTF external pipe/ SAE 45° flare

2000-(Dash size) (Ref. SAE 010102)

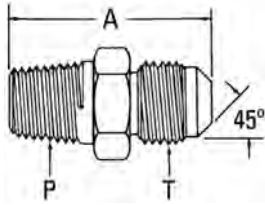

WARNING: California Proposition 65, see A-2.

Dash size	Tube O.D.		Thread P	Thread T	A	
	mm	in			mm	in
2-4B	6,3	0.25	1/8-27	7/16-20	26,9	1.06
2-5B	7,9	0.31	1/8-27	1/2-20	29,5	1.16
2-6B	9,6	0.38	1/8-27	5/8-18	31,8	1.25
4-4B	6,3	0.25	1/4-18	7/16-20	31,8	1.25
4-5B	7,9	0.31	1/4-18	1/2-20	34,0	1.34
4-6B	9,6	0.38	1/4-18	5/8-18	36,6	1.44
4-8B	12,7	0.50	1/4-18	3/4-16	41,1	1.62
6-4B	6,3	0.25	3/8-18	7/16-20	33,3	1.31
6-5B	7,9	0.31	3/8-18	1/2-20	35,1	1.38
6-6B	9,6	0.38	3/8-18	5/8-18	36,6	1.44
6-8B	12,7	0.50	3/8-18	3/4-16	41,1	1.62
6-10B	16,0	0.63	3/8-18	7/8-14	46,0	1.81
8-4B	6,3	0.25	1/2-14	7/16-20	39,6	1.56
8-6B	9,6	0.38	1/2-14	5/8-18	42,9	1.69
8-8B	12,7	0.50	1/2-14	3/4-16	46,0	1.81
8-10B	16,0	0.63	1/2-14	7/8-14	50,8	2.00
8-12B	19,0	0.75	1/2-14	1 1/16-14	55,6	2.19
12-8B	12,7	0.50	3/4-14	3/4-16	49,3	1.94
12-10B	16,0	0.63	3/4-14	7/8-14	52,3	2.06
12-12B	19,0	0.75	3/4-14	1 1/16-14	55,6	2.19

For more brass fittings see E-BRFI-MC001-E

NPTF internal pipe/ SAE 45° flare

2001-(Dash size) (Ref. SAE 010103)

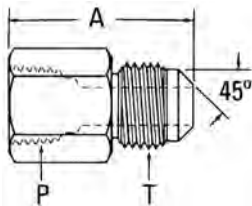

WARNING: California Proposition 65, see A-2.

Dash size	Tube O.D.		Thread P	Thread T	A	
	mm	in			mm	in
2-4B	6,3	0.25	1/8-27	7/16-20	26,9	1.06
2-5B	7,9	0.31	1/8-27	1/2-20	29,5	1.16
2-6B	6,3	0.25	1/8-27	9/16-18	28,4	1.12
4-4B	6,3	0.25	1/4-18	7/16-20	30,3	1.19
4-5B	7,9	0.31	1/4-18	1/2-20	31,8	1.25
6-4B	6,3	0.25	3/8-18	7/16-20	30,3	1.19
6-6B	9,6	0.38	3/8-18	5/8-18	33,3	1.31
6-8B	12,7	0.50	3/8-18	3/4-16	39,6	1.56
6-10B	16,0	0.63	3/8-18	7/8-14	39,6	1.56
8-6B	9,6	0.38	1/2-14	5/8-18	38,1	1.50
8-8B	12,7	0.50	1/2-14	3/4-16	41,1	1.62
8-10B	16,0	0.63	1/2-14	7/8-14	46,0	1.81
8-12B	19,0	0.75	1/2-14	1 1/16-14	50,8	2.00
12-10B	16,0	0.63	3/4-14	7/8-14	46,0	1.81
12-12B	19,0	0.75	3/4-14	1 1/16-14	49,3	1.94

Steel adapters

Pipe to 45° flare

J

Pipe to 45° flare – Brass

NPTF external pipe/ SAE 45° flare

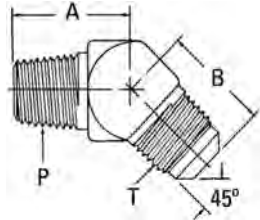

WARNING: California Proposition 65, see page A-2.

2007-(Dash size) (Ref. SAE 010302)

Dash size	Tube O.D.		Thread P	Thread T	A		B	
	mm	in			mm	in	mm	in
2-4B	6,3	0.25	1/8-27	7/16-20	16,2	0.64	17,3	0.68
4-4B	6,3	0.25	1/4-18	7/16-20	20,8	0.82	17,8	0.70
4-6B	9,6	0.38	1/4-18	5/8-18	21,8	0.86	22,6	0.89
6-6B	9,6	0.38	3/8-18	5/8-18	24,1	0.95	24,6	0.97
6-8B	12,7	0.50	3/8-18	3/4-16	24,4	0.96	29,2	1.15
6-10B	16,0	0.63	3/8-18	7/8-14	24,9	0.98	31,2	1.23
8-6B	9,6	0.38	1/2-14	5/8-18	29,7	1.17	25,1	0.99
8-8B	12,7	0.50	1/2-14	3/4-16	29,7	1.17	28,5	1.12
8-10B	16,0	0.63	1/2-14	7/8-14	29,7	1.17	31,2	1.23

For more brass fittings see E-BRF1-MC001-E

NPTF internal pipe/ SAE 45° flare

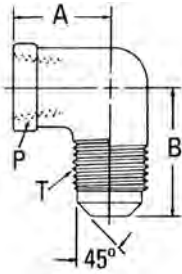

WARNING: California Proposition 65, see page A-2.

2002-(Dash size) (Ref. SAE 010203)

Dash size	Tube O.D.		Thread P	Thread T	A		B	
	mm	in			mm	in	mm	in
2-4B	6,3	0.25	1/8-27	7/16-20	11,7	0.46	22,9	0.90
4-4B	6,3	0.25	1/4-18	7/16-20	17,5	0.69	25,4	0.97
4-6B	9,6	0.38	1/4-18	5/8-18	17,5	0.69	27,7	1.09
6-4B	6,3	0.25	3/8-18	7/16-20	14,5	0.57	26,2	1.03
6-6B	9,6	0.38	3/8-18	5/8-18	27,7	1.09	26,9	1.06
6-8B	12,7	0.50	3/8-18	3/4-16	28,4	1.12	32,5	1.28
6-10B	16,0	0.63	3/8-18	7/8-14	31,0	1.22	34,3	1.35
8-8B	12,7	0.50	1/2-14	3/4-16	23,9	0.94	35,1	1.38
8-10B	16,0	0.63	1/2-14	7/8-14	25,4	1.00	38,1	1.50
8-12B	19,0	0.75	1/2-14	1 1/16-14	26,9	1.06	41,4	1.63
12-12B	19,0	0.75	3/4-14	1 1/16-14	26,9	1.06	45,2	1.78

NPTF external pipe/ SAE 45° flare

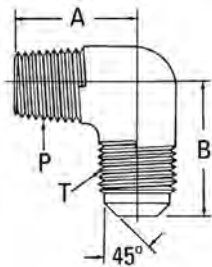

WARNING: California Proposition 65, see page A-2.

2003-(Dash size) (Ref. SAE 010202)

Dash size	Tube O.D.		Thread P	Thread T	A		B	
	mm	in			mm	in	mm	in
2-4B	6,3	0.25	1/8-27	7/16-20	19,3	0.76	20,1	0.79
2-5B	7,9	0.31	1/8-27	1/2-20	19,8	0.78	23,1	0.91
2-6B	9,6	0.38	1/8-27	5/8-18	23,1	0.91	26,2	1.03
4-4B	6,3	0.25	1/4-18	7/16-20	22,4	0.88	25,1	0.99
4-5B	7,9	0.31	1/4-18	1/2-20	23,3	0.92	24,1	0.95
4-6B	9,6	0.38	1/4-18	5/8-18	26,7	1.05	24,7	0.98
4-8B	12,7	0.50	1/4-18	3/4-16	30,2	1.19	31,2	1.23
6-4B	6,3	0.25	3/8-18	7/16-20	26,2	1.03	23,9	0.94
6-5B	7,9	0.31	3/8-18	1/2-20	23,1	0.91	25,4	1.00
6-6B	9,6	0.38	3/8-18	5/8-18	27,7	1.09	26,4	1.04
6-8B	12,7	0.50	3/8-18	3/4-16	28,4	1.12	31,2	1.23
6-10B	16,0	0.63	3/8-18	7/8-14	31,0	1.22	36,1	1.42
8-6B	9,6	0.38	1/2-14	5/8-18	34,3	1.35	29,5	1.16
8-8B	12,7	0.50	1/2-14	3/4-16	31,8	1.25	33,5	1.32
8-10B	16,0	0.63	1/2-14	7/8-14	34,8	1.37	36,1	1.42
8-12B	19,0	0.75	1/2-14	1 1/16-14	37,6	1.48	41,1	1.62
12-8B	12,7	0.50	3/4-14	3/4-16	37,6	1.48	41,1	1.62
12-10B	16,0	0.63	3/4-14	7/8-14	33,3	1.31	36,3	1.43
12-12B	19,0	0.75	3/4-14	1 1/16-14	38,1	1.50	41,1	1.62

For more brass fittings see document E-BRF1-MC001-E

Pipe to SAE O-Ring boss

NPTF external pipe/SAE O-Ring boss (internal)

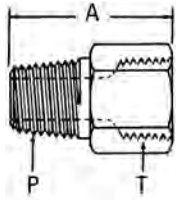

2246-(Dash size)

(Formerly Weatherhead series C3239x)

Dash size	Thread P	Thread T	A	
			mm	in
2-4S	1/8-27	7/16-20	27,7	1.09
2-5S	1/8-27	1/2-20	27,7	1.09
4-6S	1/4-18	9/16-18	34,5	1.36
6-6S	3/8-18	9/16-18	35,1	1.38
6-8S	3/8-18	3/4-16	36,8	1.45
8-6S	1/2-14	9/16-18	40,6	1.60
8-8S	1/2-14	3/4-16	42,4	1.67
8-10S	1/2-14	7/8-14	45,2	1.78
12-12S	3/4-14	1 1/16-12	48,8	1.92
12-14S	3/4-14	1 3/16-12	48,8	1.92
16-16S	1-11 1/2	1 5/16-12	54,1	2.13

NPSM internal pipe swivel/SAE O-Ring boss

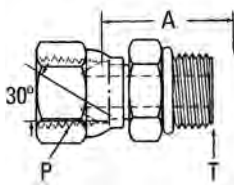

2066-(Dash size)

(Formerly Weatherhead series 9315x)

Dash size	Thread P	Thread T	A	
			mm	in
4-4S	1/4-18	7/16-20	26,7	1.05
4-5S	1/4-18	1/2-20	25,9	1.02
4-6S	1/4-18	9/16-18	29,0	1.14
4-8S	1/4-18	3/4-16	32,0	1.26
6-4S	3/8-18	7/16-20	26,6	1.05
6-6S	3/8-18	9/16-18	29,0	1.14
6-8S	3/8-18	3/4-16	30,3	1.19
6-10S	3/8-18	7/8-14	33,5	1.32
8-6S	1/2-14	9/16-18	31,0	1.22
8-8S	1/2-14	3/4-16	31,2	1.23
8-10S	1/2-14	7/8-14	33,0	1.30
8-12S	1/2-14	1 1/16-12	37,1	1.46
12-8S	3/4-14	3/4-16	37,8	1.49
12-10S	3/4-14	7/8-14	39,4	1.55
12-12S	3/4-14	1 1/16-12	40,1	1.58
12-14S	3/4-14	1 3/16-12	40,1	1.58
12-16S	3/4-14	1 5/16-12	47,2	1.86
16-16S	1-11 1/2	1 5/16-12	40,4	1.59
16-20S	1-11 1/2	1 5/8-12	40,4	1.59
20-20S	1 1/4-11 1/2	1 5/8-12	48,5	1.91
24-24S	1 1/2-11 1/2	1 7/8-12	51,3	2.02

Note: Available without O-Ring. Order by 206604-(dash size).

Steel adapters

Pipe to SAE O-Ring boss

J

Pipe to SAE O-Ring boss

NPTF internal pipe/SAE O-Ring boss

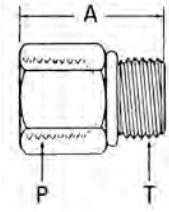

2216-(Dash size)
(Formerly Weatherhead series C3269x)

Dash size	Thread P	Thread T	A	
			mm	in
2-4S	1/8-27	7/16-20	23,4	0.92
2-5S	1/8-27	1/2-20	31,0	1.22
4-4S	1/4-18	7/16-20	30,5	1.20
4-5S	1/4-18	1/2-20	30,5	1.20
4-6S	1/4-18	9/16-18	31,5	1.24
4-8S	1/4-18	3/4-16	26,9	1.06
4-10S	1/4-18	7/8-14	20,6	0.81
6-6S	3/8-18	9/16-18	33,0	1.30
6-6S	3/8-18	9/16-18	33,0	1.30
6-8S	3/8-18	3/4-16	31,8	1.25
6-10S	3/8-18	7/8-14	31,7	1.25
8-6S	1/2-14	9/16-18	37,1	1.46
6-12S	3/8-18	1 1/16-12	34,0	1.34
8-8S	1/2-14	3/4-16	41,9	1.65
8-10S	1/2-14	7/8-14	39,1	1.54
8-12S	1/2-14	1 1/16-12	43,7	1.72
8-16S	1/2-14	1 5/16-12	25,4	1.00
12-10S	3/4-14	7/8-14	45,0	1.77
12-12S	3/4-14	1 1/16-12	42,4	1.67
12-14S	3/4-14	1 3/16-12	42,7	1.68
12-16S	3/4-14	1 5/16-12	25,4	1.00
16-16S	1-11 1/2	1 5/16-12	48,5	1.91
16-20S	1-11 1/2	1 5/8-12	25,4	1.00
20-20S	1 1/4-11 1/2	1 5/8-12	50,8	2.00
24-24S	1 1/2-11 1/2	1 7/8-12	50,8	2.00
32-32S	2-11 1/2	2 1/2-12	53,3	2.10

Note: Also available without O-Ring. Order by 2216-1-(dash size).

NPSM internal pipe swivel/SAE O-Ring boss (adj.)

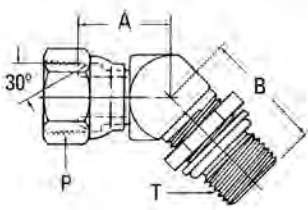

2067-(Dash size)
(Formerly Weatherhead series 9365x)

Dash size	Thread P	Thread T	A		B	
			mm	in	mm	in
4-4S	1/4-18	7/16-20	15,5	0.61	27,4	1.08
6-4S	3/8-18	7/16-18	20,1	0.72	28,0	1.10
6-6S	3/8-18	9/16-18	23,4	0.92	30,5	1.20
6-8S	3/8-18	3/4-16	23,4	0.92	33,8	1.33
8-6S	1/2-14	9/16-18	23,1	0.91	30,5	1.20
8-8S	1/2-14	3/4-16	23,1	0.91	35,3	1.39
8-10S	1/2-14	7/8-14	23,1	0.91	39,4	1.55
12-8S	3/4-14	3/4-16	27,9	1.10	36,6	1.44
12-12S	3/4-14	1 1/16-12	27,9	1.10	44,7	1.76
12-16S	3/4-14	1 5/16-12	27,9	1.10	48,0	1.89
16-16S	1-11 1/2	1 5/16-12	32,0	1.26	48,0	1.89
20-20S	1 1/4-11 1/2	1 5/8-12	30,5	1.20	48,5	1.91

Note: Available without O-Ring. Order by 2067-1-(dash size).

Pipe to SAE O-Ring boss

NPSM internal pipe swivel/SAE O-Ring boss (adj.)

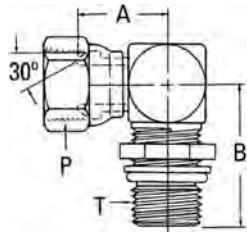

2068-(Dash size) (Formerly Weatherhead series 9515x)

Dash size	Thread P	Thread T	A		B	
			mm	in	mm	in
4-4S	1/4-18	7/16-20	23,1	0.91	29,5	1.16
4-6S	1/4-18	9/16-18	23,1	0.91	31,0	1.22
6-4S	3/8-18	7/16-20	27,7	1.09	33,8	1.33
6-6S	3/8-18	9/16-18	27,7	1.09	34,3	1.35
6-8S	3/8-18	3/4-16	27,7	1.09	37,6	1.48
6-10S	3/8-18	7/8-14	27,7	1.09	42,4	1.67
8-6S	1/2-14	9/16-18	27,4	1.08	38,4	1.51
8-8S	1/2-14	3/4-16	27,4	1.08	38,4	1.51
8-10S	1/2-14	7/8-14	27,4	1.08	42,4	1.67
8-12S	1/2-14	1 1/16-12	30,0	1.18	50,0	1.97
12-8S	3/4-14	3/4-16	33,0	1.30	41,9	1.65
12-10S	3/4-14	7/8-14	33,5	1.32	46,0	1.81
12-12S	3/4-14	1 1/16-12	34,5	1.36	50,0	1.97
12-16S	3/4-14	1 5/16-12	35,8	1.41	53,8	2.12
16-16S	1-11 1/2	1 5/16-12	38,9	1.53	53,8	2.12
20-16S	1 1/4-11 1/2	1 5/16-12	46,2	1.82	63,5	2.50
20-20S	1 1/4-11 1/2	1 5/8-12	46,2	1.82	63,5	2.50

Note: Available without O-Ring. Order by 2068-1-(dash size).

NPTF internal pipe/SAE O-Ring boss (adj.)

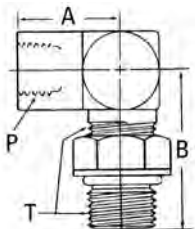

206801-(Dash size) (Formerly Weatherhead series C3459x)

Dash size	Thread P	Thread T	A		B	
			mm	in	mm	in
4-6S	1/4-18	9/16-18	22,4	0.88	34,3	1.35
6-8S	3/8-18	3/4-16	25,9	1.02	41,1	1.62
8-8S	1/2-14	3/4-16	31,2	1.23	43,9	1.73
8-10S	1/2-14	7/8-14	31,2	1.23	48,0	1.89
12-12S	3/4-14	1 1/16-12	34,5	1.36	55,2	2.17
16-16S	1-11 1/2	1 5/16-12	41,1	1.62	61,2	2.41
20-20S	1 1/4-11 1/2	1 5/8-12	43,2	1.70	63,5	2.50

Note: Available without O-Ring. Order by 206801-1-(dash size).

NPTF internal pipe/SAE O-Ring boss (adj.)

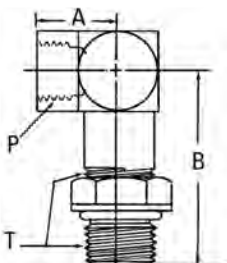

206804-(Dash size) (Formerly Weatherhead series C3469x)

Dash size	Thread P	Thread T	A		B	
			mm	in	mm	in
6-8S	3/8-18	3/4-16	25,9	1.02	75,4	2.97
8-10S	1/2-14	7/8-14	31,2	1.23	90,4	3.56
12-12S	3/4-14	1 1/16-12	34,5	1.36	104,6	4.12
16-16S	1-11 1/2	1 5/16-12	41,1	1.62	117,8	4.64

Note: Available without O-Ring. Order by 206804-1-(dash size).

Steel adapters

Pipe to braze and weld
SAE 37° flare union

J

Pipe to braze and weld

Braze port/ NPTF external pipe

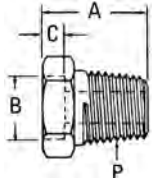

73056-(Dash size)

Dash size	Tube O.D.		Thread P	A		B		C	
	mm	in		mm	in	mm	in	mm	in
2-4S	6,3	0.25	1/8-27	16,8	0.66	6,3	0.25	4,0	0.16
2-6S	9,6	0.38	1/8-27	18,0	0.71	9,6	0.38	4,0	0.16
4-6S	9,6	0.38	1/4-18	22,5	0.89	9,6	0.38	4,0	0.16
16S	25,4	1.00	1-11 1/2	33,6	1.32	25,4	1.00	6,4	0.25

Braze port/ NPTF external pipe

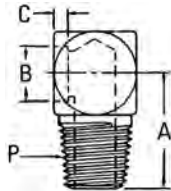

FF1159-(Dash size)

Dash size	Tube O.D.		Thread P	A		B		C	
	mm	in		mm	in	mm	in	mm	in
0406S	9,6	0.38	1/4-18	22,9	0.90	9,7	0.38	4,0	0.16
2020S	31,7	1.25	1 1/4-11 1/2	59,7	2.35	31,8	1.25	6,4	0.25

SAE 37° (JIC) flare union

Union SAE 37° flare/SAE 37° flare

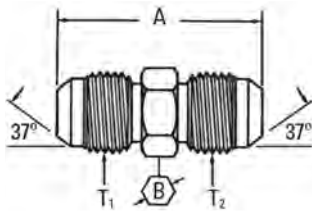

2027-(Dash size) (Ref. SAE 070101) (Formerly Weatherhead series C5305x)

Dash size	Tube O.D.		Thread T1	Thread T2	A		B	
	mm	in			mm	in	mm	in
2-2S	3,3	0.13	5/16-24	5/16-24	29,7	1.17	11,2	0.44
3-3S	4,8	0.19	3/8-24	3/8-24	31,2	1.23	11,2	0.44
4-3S	4,8	0.19	7/16-20	3/8-24	33,0	1.30	12,7	0.50
4-4S*	6,3	0.25	7/16-20	7/16-20	34,8	1.37	12,7	0.50
5-4S	6,3	0.25	1/2-20	7/16-20	34,8	1.37	14,2	0.56
5-5S	7,9	0.31	1/2-20	1/2-20	34,8	1.37	14,2	0.56
6-4S	6,3	0.25	9/16-18	7/16-20	35,6	1.40	15,7	0.62
6-5S	7,9	0.31	9/16-18	1/2-20	35,6	1.40	15,7	0.62
6-6S*	9,6	0.38	9/16-18	9/16-18	35,8	1.41	15,7	0.62
8-4S	6,3	0.25	3/4-16	7/16-20	38,4	1.51	20,6	0.81
8-6S	9,6	0.38	3/4-16	9/16-18	38,6	1.52	20,6	0.81
8-8S*	12,7	0.50	3/4-16	3/4-16	41,1	1.62	20,6	0.81
10-6S	9,6	0.38	7/8-14	9/16-18	42,7	1.68	23,9	0.94
10-8S	12,7	0.50	7/8-14	3/4-16	45,2	1.78	23,9	0.94
10-10S	16,0	0.63	7/8-14	7/8-14	47,8	1.88	23,9	0.94
12-8S	9,6	0.38	1 1/16-12	3/4-16	49,5	1.95	28,4	1.12
12-10S	15,5	0.61	1 1/16-12	7/8-14	52,1	2.05	28,4	1.12
12-12S*	19,0	0.75	1 1/16-12	1 1/16-12	54,9	2.16	28,4	1.12
14-14S	21,1	0.83	1 3/16-12	1 3/16-12	56,1	2.21	31,8	1.25
16-12S	19,0	0.75	1 5/16-12	1 1/16-12	55,9	2.20	35,1	1.38
16-16S*	25,4	1.00	1 5/16-12	1 5/16-12	57,2	2.25	35,1	1.38
20-16S	25,4	1.00	1 5/8-12	1 5/16-12	60,5	2.38	42,7	1.68
20-20S	31,7	1.25	1 5/8-12	1 5/8-12	61,7	2.43	42,9	1.69
24-24S	38,1	1.50	1 7/8-12	1 7/8-12	69,9	2.75	50,8	2.00
32-32S	50,8	2.00	2 1/2-12	2 1/2-12	86,4	3.40	66,5	2.62

* Also available in stainless steel as 259-2027-(dash size).
(Formerly Weatherhead 5317x)

SAE 37° flare union

SAE 37° flare/SAE 37° flare (large hex)

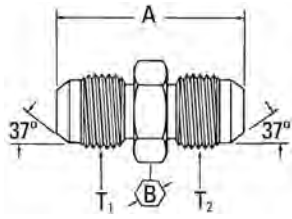

202712-(Dash size) (Ref. SAE 070119)
(Formerly Weatherhead series C5306x)

Dash size	Tube O.D.		Thread T1	Thread T2	A		B	
	mm	in			mm	in	mm	in
4-4S	6,3	0.25	7/16-20	7/16-20	34,8	1.37	17,5	0.69
6-4S	6,3	0.25	9/16-18	7/16-20	35,6	1.40	20,6	0.81
6-6S	7,9	0.31	9/16-18	9/16-18	35,6	1.40	20,6	0.81
8-8S	12,7	0.50	3/4-16	3/4-16	41,1	1.62	25,4	1.00
10-8S	12,7	0.50	7/8-14	3/4-16	45,2	1.78	28,5	1.12
10-10S	16,0	0.63	7/8-14	7/8-14	47,7	1.88	28,5	1.12
12-12S	19,0	0.75	1 1/16-12	1 1/16-12	54,9	2.16	35,1	1.38
16-16S	25,4	1.00	1 5/16-12	1 5/16-12	57,2	2.25	41,1	1.62
20-20S	31,7	1.25	1 5/8-12	1 5/8-12	61,7	2.43	47,6	1.88

SAE 37° flare bulkhead/SAE 37° flare

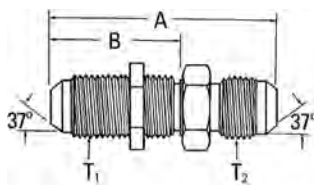

2041-(Dash size) (Ref. SAE 070601)
(Formerly Weatherhead series C5325x)

Dash size	Tube O.D.		Thread T1	Thread T2	A		B	
	mm	in			mm	in	mm	in
3-3S	4,80	0.19	3/8-24	3/8-24	48,3	1.9	29,0	1.14
4-4S	6,3	0.25	7/16-20	7/16-20	52,6	2.07	31,2	1.23
4-6S	9,6	0.38	7/16-20	9/16-18	53,3	2.10	31,2	1.23
5-5S	7,9	0.31	1/2-20	1/2-20	52,6	2.07	31,2	1.23
6-6S	9,6	0.38	9/16-18	9/16-18	55,4	2.18	33,3	1.31
8-8S*	12,7	0.50	3/4-16	3/4-16	62,0	2.44	37,3	1.47
10-10S	16,0	0.63	7/8-14	7/8-14	69,6	2.74	40,9	1.61
12-12S	19,0	0.75	1 1/16-12	1 1/16-12	78,5	3.09	45,2	1.78
12-16S	25,4	1.00	1 1/16-12	1 5/16-12	79,8	3.14	45,2	1.78
16-16S	25,4	1.00	1 5/16-12	1 5/16-12	79,8	3.14	45,2	1.78
20-20S	31,7	1.25	1 5/8-12	1 5/8-12	84,1	3.31	46,5	1.83
24-24S	38,1	1.50	1 7/8-12	1 7/8-12	89,4	3.52	46,7	1.84

Note: Available without nut. Order by 2041-1-(dash size).

* Also available in stainless steel without nut as part number 259-2041-1-(dash size). (Formerly Weatherhead 5337x)

SAE 37° flare plug

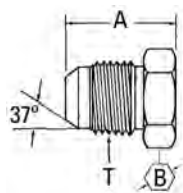

900599-(Dash size) (Ref. SAE 070109)
(Formerly Weatherhead series C5229x)

Dash size	Tube O.D.		Thread T1	A		B	
	mm	in		mm	in	mm	in
3S	4,8	0.19	3/8-24	18,5	0.73	11,2	0.44
4S	6,3	0.25	7/16-20	20,3	0.80	12,7	0.50
5S	7,9	0.31	1/2-20	20,3	0.80	14,2	0.56
6S*	9,6	0.38	9/16-18	21,3	0.84	15,7	0.62
8S	12,7	0.50	3/4-16	23,9	0.94	20,6	0.81
10S	16,0	0.63	7/8-14	27,9	1.10	23,9	0.94
12S*	19,0	0.75	1 1/16-12	32,5	1.28	28,4	1.12
14S	21,1	0.83	1 3/16-12	33,3	1.31	31,8	1.25
16S	25,4	1.00	1 5/16-12	33,8	1.33	35,1	1.38
20S	31,7	1.25	1 5/8-12	36,8	1.45	42,9	1.69
24S	38,1	1.50	1 7/8-12	41,9	1.65	50,8	2.00
32S	50,8	2.00	2 1/2-12	52,1	2.05	66,5	2.62

* Also available in stainless steel as part number 259-900599-(dash size). (Formerly Weatherhead 5241x).

Steel adapters

SAE 37° flare union

J

SAE 37° flare union

Cap nut

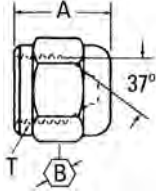

210292-(Dash size) (Ref. SAE 070112)
(Formerly Weatherhead series C5129x)

Dash size	Tube O.D.		Thread T	A		B	
	mm	in		mm	in	mm	in
3S	4,8	0.19	3/8-24	14,2	0.56	11,2	0.44
4S*	6,3	0.25	7/16-20	15,0	0.59	14,2	0.56
5S	7,9	0.31	1/2-20	15,5	0.61	15,7	0.62
6S*	9,6	0.38	9/16-18	15,7	0.62	17,6	0.69
8S*	12,7	0.50	3/4-16	19,0	0.75	22,4	0.88
10S	16,0	0.63	7/8-14	21,3	0.84	25,4	1.00
12S*	19,0	0.75	1 1/16-12	23,1	0.91	31,8	1.25
16S	25,4	1.00	1 5/16-12	25,9	1.02	38,1	1.50
20S	31,7	1.25	1 5/8-12	26,9	1.06	50,8	2.00
24S	38,1	1.50	1 7/8-12	30,3	1.19	57,2	2.25
32S	50,8	2.00	2 1/2-12	36,6	1.44	73,1	2.88

* Also available in stainless steel as stainless steel as 259-210292-(dash size)
(Formerly Weatherhaed 5141x)

SAE 37° flare (internal)/SAE 37° flare

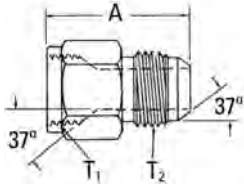

2215-(Dash size)
(Formerly Weatherhead series C5015x)

Dash size	Tube O.D.		Thread T1	Thread T2	A	
	mm	in			mm	in
4-6S	9,6	0.38	9/16-18	7/16-20	31,8	1.25
6-5S	7,9	0.31	9/16-18	1/2-20	30,0	1.18
8-10S	16,0	0.63	3/4-16	7/8-14	38,4	1.51
10-4S	6,3	0.25	7/8-14	7/16-20	35,6	1.40
10-6S	9,6	0.38	7/8-14	9/16-18	35,8	1.41
10-8S	12,7	0.50	7/8-14	3/4-16	38,9	1.53
10-12S	19,0	0.75	7/8-14	1 1/16-12	44,2	1.74
12-10S	16,0	0.63	1 1/16-12	7/8-14	43,9	1.73
12-16S	25,4	1.00	1 1/16-12	1 5/16-12	50,8	2.00
14-8S	12,7	0.50	1 3/16-12	3/4-16	42,9	1.69
16-8S	12,7	0.50	1 5/16-12	3/4-16	42,4	1.67
16-10S	16,0	0.63	1 5/16-12	7/8-14	45,2	1.78
16-20S	31,8	1.25	1 5/16-12	1 5/8-12	58,4	2.30
20-16S	25,4	1.00	1 5/8-12	1 5/16-12	50,3	1.98
24-16S	25,4	1.00	1 7/8-12	1 5/16-12	58,7	2.31
24-20S	31,8	1.25	1 7/8-12	1 5/8-12	58,4	2.30
24-32S	50,8	2.00	1 7/8-12	2 1/2-12	68,1	2.68
32-24S	38,1	1.50	2 1/2-12	1 7/8-12	64,0	2.52

SAE 37° flare union

SAE 37° flare swivel reducer/SAE 37° flare

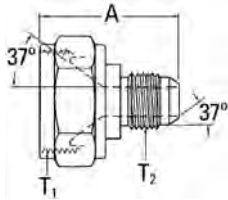

221501-(Dash size) (Ref. SAE 070123)
(Formerly Weatherhead series C5015x)

Dash size	Tube O.D.		Thread T1	Thread T2	A	
	mm	in			mm	in
6-4S	6,3	0.25	9/16-18	7/16-20	35,6	1.40
8-4S	6,3	0.25	3/4-16	7/16-20	38,1	1.50
8-6S	9,6	0.38	3/4-16	9/16-18	38,1	1.50
10-6S	9,6	0.38	7/8-14	9/16-18	41,1	1.62
12-4	6,3	0.25	1 1/16-12	7/16-20	27,7	1.09
12-6S	9,6	0.38	1 1/16-12	9/16-18	42,9	1.69
12-8S	12,7	0.50	1 1/16-12	3/4-16	45,5	1.79
16-6S	9,6	0.38	1 5/16-12	9/16-18	46,7	1.84
16-8S	12,7	0.50	1 5/16-12	3/4-16	49,3	1.94
16-10S	16,0	0.63	1 5/16-12	7/8-14	51,8	2.04
16-12S	19,0	0.75	1 5/16-12	1 1/16-12	54,6	2.15
20-12	19,0	0.75	1 5/8-12	1 1/16-12	38,1	1.50
20-16S	25,4	1.00	1 5/8-12	1 5/16-12	56,6	2.23

Note: Available without nut. Order by Part no. FF1066-(dash size).

SAE 37° flare bulkhead/SAE 37° flare

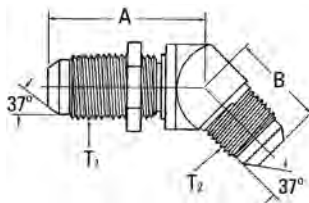

2042-(Dash size) (Ref. SAE 070801)
(Formerly Weatherhead series C5375x)

Dash size	Tube O.D.		Thread T1	Thread T2	A		B	
	mm	in			mm	in	mm	in
4-4S	6,3	0.25	7/16-20	7/16-20	38,9	1.53	18,3	0.72
5-5S	7,9	0.31	1/2-20	1/2-20	42,2	1.66	19,6	0.77
6-6S	9,6	0.38	9/16-18	9/16-18	42,4	1.67	21,1	0.83
8-8S	12,7	0.50	3/4-16	3/4-16	49,3	1.94	24,9	0.98
10-10S	16,0	0.63	7/8-14	7/8-14	55,1	2.17	28,2	1.11
12-12S	19,0	0.75	1 1/16-12	1 1/16-12	35,8	1.41	59,9	2.36
16-16S	25,4	1.00	1 5/16-12	1 5/16-12	37,3	1.47	63,5	2.58
20-20S	31,7	1.25	1 5/8-12	1 5/8-12	64,3	2.53	42,9	1.69

Note: Available without nut. Order by 2042-1-(dash size).

SAE 37° flare swivel/SAE 37° flare

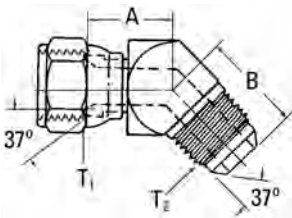

2070-(Dash size) (Ref. SAE 070321)
(Formerly Weatherhead series C5356x)

Dash size	Tube O.D.		Thread T1	Thread T2	A		B	
	mm	in			mm	in	mm	in
4-4S	6,3	0.25	7/16-20	7/16-20	15,2	0.60	18,3	0.72
5-5S	7,9	0.31	1/2-20	1/2-20	15,7	0.62	19,6	0.77
6-6S	9,6	0.38	9/16-18	9/16-18	18,8	0.74	21,1	0.83
8-8S	12,7	0.50	3/4-16	3/4-16	21,8	0.86	24,9	0.98
10-10S	16,0	0.63	7/8-14	7/8-14	23,9	0.94	28,2	1.11
12-12S	19,0	0.75	1 1/16-12	1 1/16-12	23,9	0.94	32,5	1.28
14-14S	22,3	0.88	1 3/16-12	1 3/16-12	26,4	1.04	36,8	1.45
16-16S	25,4	1.00	1 5/16-12	1 5/16-12	29,5	1.16	37,3	1.47
20-20S	31,7	1.25	1 5/8-12	1 5/8-12	35,6	1.40	40,4	1.59

Steel adapters

SAE 37° flare union

J

SAE 37° flare union

SAE 37° flare/SAE 37° flare

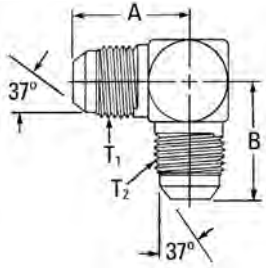

2039-(Dash size) (Ref. SAE 070201)
(Formerly Weatherhead series C5505x)

Dash size	Tube O.D.		Thread T1	Thread T2	A		B	
	mm	in			mm	in	mm	in
4-4S	6,3	0.25	7/16-20	7/16-20	22,6	0.89	22,6	0.89
5-5S	7,9	0.31	1/2-20	1/2-20	24,1	0.95	24,1	0.95
6-6S	9,6	0.38	9/16-18	9/16-18	26,9	1.06	26,9	1.06
8-6S	9,6	0.38	3/4-16	9/16-16	31,8	1.25	29,0	1.14
8-8S	12,7	0.50	3/4-16	3/4-16	31,8	1.25	31,8	1.25
10-10S	16,0	0.63	7/8-14	7/8-14	36,8	1.45	36,8	1.45
12-12S	19,0	0.75	1 1/16-12	1 1/16-12	42,2	1.66	42,2	1.66
16-12S	19,0	0.75	1 5/16-12	1 1/16-12	46,0	1.81	44,7	1.76
16-16S	25,4	1.00	1 5/16-12	1 5/16-12	46,0	1.81	46,0	1.81
20-20S	31,7	1.25	1 5/8-12	1 5/8-12	52,3	2.06	52,3	2.06
24-24S	38,1	1.50	1 7/8-12	1 7/8-12	59,2	2.33	59,2	2.33
32-32S	50,8	2.00	2 1/2-12	2 1/2-12	77,7	3.06	77,7	3.06

SAE 37° flare bulkhead/SAE 37° flare

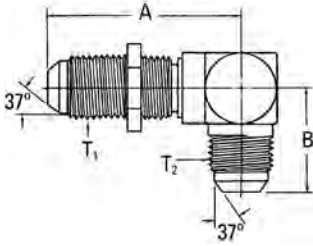

2043-(Dash size) (Ref. SAE 070701)
(Formerly Weatherhead series C5525x)

Dash size	Tube O.D.		Thread T1	Thread T2	A		B	
	mm	in			mm	in	mm	in
4-4S	6,3	0.25	7/16-20	7/16-20	40,4	1.59	24,6	0.97
5-5S	7,9	0.31	1/2-20	1/2-20	43,7	1.72	26,9	1.06
6-6S	9,6	0.38	9/16-18	9/16-18	46,0	1.81	27,7	1.09
8-8S	12,7	0.50	3/4-16	3/4-16	53,6	2.11	34,5	1.36
10-10S	16,0	0.63	7/8-14	7/8-14	60,7	2.39	39,6	1.56
12-12S	19,0	0.75	1 1/16-12	1 1/16-12	67,8	2.67	45,2	1.78
16-16S	25,4	1.00	1 5/16-12	1 5/16-12	71,1	2.80	49,3	1.94

SAE 37° flare swivel/SAE 37° flare

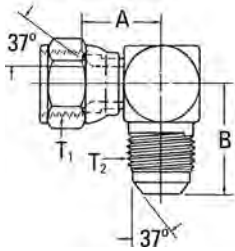

2071-(Dash size) (Ref. SAE 070221)
(Formerly Weatherhead series C5506x)

Dash size	Tube O.D.		Thread T1	Thread T2	A		B	
	mm	in			mm	in	mm	in
4-4S*	6,3	0.25	7/16-20	7/16-20	16,8	0.66	22,6	0.89
4-6S	9,6	0.38	7/16-20	9/16-18	20,8	0.82	26,9	1.06
5-5S	7,9	0.31	1/2-20	1/2-20	17,3	0.68	24,1	0.95
6-4S	6,3	0.25	9/16-18	7/16-20	22,4	0.88	26,7	1.05
6-6S*	9,6	0.38	9/16-18	9/16-18	22,4	0.88	26,9	1.06
8-6S	9,6	0.38	3/4-16	9/16-18	24,4	0.96	29,0	1.14
8-8S	12,7	0.50	3/4-16	3/4-16	24,4	0.96	31,8	1.25
8-10S	16,0	0.63	3/4-16	7/8-14	25,4	1.00	36,8	1.45
10-8S	12,7	0.50	7/8-14	3/4-16	28,4	1.12	33,8	1.33
10-10S	16,0	0.63	7/8-14	7/8-14	28,4	1.12	36,8	1.45
12-12S	19,0	0.75	1 1/16-12	1 1/16-12	30,2	1.19	42,2	1.66
14-14S	22,3	0.88	1 3/16-12	1 3/16-12	30,5	1.20	45,7	1.80
16-16S	25,4	1.00	1 5/16-12	1 5/16-12	35,8	1.41	46,0	1.81
20-20S	31,7	1.25	1 5/8-12	1 5/8-12	42,7	1.68	52,3	2.06
24-24S	38,1	1.50	1 7/8-12	1 7/8-12	47,2	1.86	59,2	2.33
32-32S	50,8	2.00	2 1/2-12	2 1/2-12	62,0	2.44	77,7	3.06

* Also available in stainless steel as part number 259-2071-(dash size).
(Formerly Weatherhead 5518x)

SAE 37° flare union

SAE 37° flare swivel/SAE 37° flare

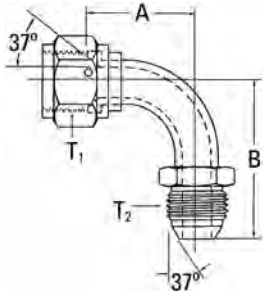

FF5163-(Dash size)

Dash size	Tube O.D.		Thread T1	Thread T2	A		B	
	mm	in			mm	in	mm	in
0808S	12,7	0.50	3/4-16	3/4-16	47,5	1.87	54,9	2.16
1212S	19,0	0.75	1 1/16-12	1 1/16-12	59,7	2.35	71,4	2.81
1616S	25,4	1.00	1 5/16-12	1 5/16-12	77,2	3.04	86,6	3.41
2020S	31,7	1.25	1 5/8-12	1 5/8-12	86,4	3.40	94,2	3.71
2424S	38,1	1.50	1 7/8-12	1 7/8-12	100,3	3.95	110,0	4.33

SAE 37° flare swivel/SAE 37° flare

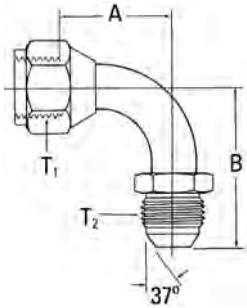

500454-(Dash size)

Dash size	Tube O.D.		Thread T1	Thread T2	A		B	
	mm	in			mm	in	mm	in
4S	6,3	0.25	7/16-20	7/16-20	17,3	0.68	28,5	1.12
6S	9,6	0.38	9/16-18	9/16-18	21,6	0.85	33,3	1.31
8S	12,7	0.50	3/4-16	3/4-16	27,7	1.09	42,2	1.66
10S	16,0	0.63	7/8-14	7/8-14	31,2	1.23	46,2	1.82
12S	19,0	0.75	1 1/16-12	1 1/16-12	46,2	1.82	63,2	2.49
16S	25,4	1.00	1 5/16-12	1 5/16-12	60,7	2.39	70,9	2.79
20S	31,7	1.25	1 5/8-12	1 5/8-12	69,8	2.75	79,7	3.14

SAE 37° flare swivel/SAE 37° flare

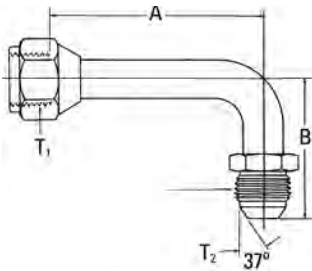

504095-(Dash size)

Dash size	Tube O.D.		Thread T1	Thread T2	A		B	
	mm	in			mm	in	mm	in
4S	6,3	0.25	7/16-20	7/16-20	45,7	1.80	28,5	1.12
5S	7,9	0.31	1/2-20	1/2-20	44,9	1.77	31,5	1.24
6S	9,6	0.38	9/16-18	9/16-18	55,4	2.18	33,3	1.31
8S	12,7	0.50	3/4-16	3/4-16	61,7	2.43	45,2	1.78
10S	16,0	0.63	7/8-14	7/8-14	65,3	2.57	52,6	2.07
12S	19,0	0.75	1 1/16-12	1 1/16-12	94,7	3.73	63,2	2.49
16S	25,4	1.00	1 5/16-12	1 5/16-12	116,3	4.58	70,9	2.79
20S	31,7	1.25	1 5/8-12	1 5/8-12	140,5	5.53	79,7	3.14

Steel adapters

SAE 37° flare union

J

SAE 37° flare union

SAE 37° flare swivel/SAE 37° flare

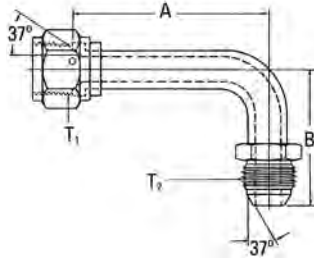

FF5164-(Dash size)

Dash size	Tube O.D.		Thread T1	Thread T2	A		B	
	mm	in			mm	in	mm	in
0808S	12,7	0.50	3/4-16	3/4-16	84,8	3.34	54,9	2.16
1212S	19,0	0.75	1 1/16-12	1 1/16-12	112,0	4.41	71,4	2.81
1616S	25,4	1.00	1 5/16-12	1 5/16-12	133,1	5.24	86,6	3.41
2020S	31,7	1.25	1 5/8-12	1 5/8-12	164,6	6.48	94,2	3.71

SAE 37° flare/SAE 37° flare/SAE 37° flare

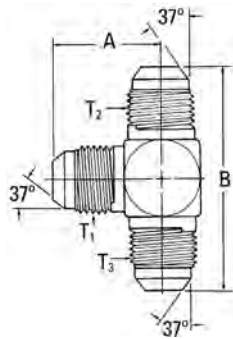

2033-(Dash size) (Ref. SAE 070401) (Formerly Weatherhead series C5705x)

Dash size	Tube O.D.		Thread T	Thread T2	Thread T3	A		B	
	mm	in				mm	in	mm	in
4-4S	6,3	0.25	7/16-20	7/16-20	7/16-20	22,6	0.89	45,2	1.78
5-5S	7,9	0.31	1/2-20	1/2-20	1/2-20	24,1	0.95	48,3	1.90
6-6S	9,6	0.38	9/16-18	9/16-18	9/16-18	26,9	1.06	53,8	2.12
8-6-6S	9,6	0.38	3/4-16	9/16-18	9/16-18	31,8	1.25	57,9	2.28
8-8S	12,7	0.50	3/4-16	3/4-16	3/4-16	31,8	1.25	63,5	2.50
8-12-12S	19,0	0.75	3/4-16	1 1/16-12	1 1/16-12	36,1	1.42	84,3	3.32
10-10S	16,0	0.63	7/8-14	7/8-14	7/8-14	36,8	1.45	73,7	2.90
12-12S	19,0	0.75	1 1/16-12	1 1/16-12	1 1/16-12	42,2	1.66	84,3	3.32
12-12-16S	19,0	0.75	1 1/16-12	1 1/16-12	1 5/16-12	44,7	1.76	92,7	3.65
16-16S	25,4	1.00	1 5/16-12	1 5/16-12	1 5/16-12	46,0	1.81	91,9	3.62
16-16-20S	31,7	1.25	1 5/16-12	1 5/16-12	1 5/8-12	50,8	2.00	103,1	4.06
20-16-16S	25,4	1.00	1 5/8-12	1 5/16-12	1 5/16-12	52,3	2.06	102,1	4.02
20-20S	31,7	1.25	1 5/8-12	1 5/8-12	1 5/8-12	52,3	2.06	104,6	4.12
24-24S	38,1	1.50	1 7/8-12	1 7/8-12	1 7/8-12	59,2	2.33	118,4	4.66

SAE 37° flare bulkhead/SAE 37° flare

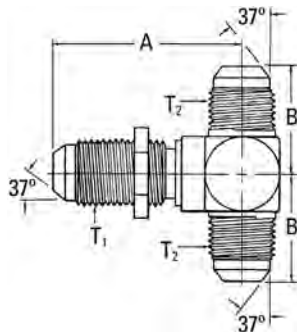

203002-(Dash size) (Ref. SAE 070959) (Formerly Weatherhead series C5725x)

Dash size	Tube O.D.		Thread T	Thread T2	A		B	
	mm	in			mm	in	mm	in
4-4S	6,3	0.25	7/16-20	7/16-20	40,4	1.59	24,6	0.97
5-5S	7,9	0.31	1/2-20	1/2-20	43,7	1.72	26,9	1.06
6-6S	9,6	0.38	9/16-18	9/16-18	46,0	1.81	27,7	1.09
8-8S	12,7	0.50	3/4-16	3/4-16	53,6	2.11	34,5	1.36
10-10S	16,0	0.63	7/8-14	7/8-14	60,7	2.39	39,6	1.56
12-12S	19,0	0.75	1 1/16-12	1 1/16-12	67,8	2.67	45,2	1.78
16-16S	25,4	1.00	1 5/16-12	1 5/16-12	71,1	2.80	49,3	1.94

Note: Available without nut. Order by 203002-1-(dash size).

SAE 37° flare union

SAE 37° flare bulkhead/SAE 37° flare

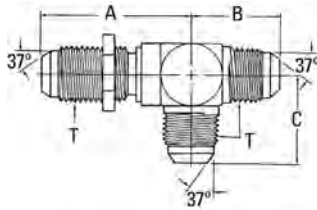

203008-(Dash size) (Ref. SAE 070958)

Dash size	Tube O.D.		Thread T	A		B		C	
	mm	in		mm	in	mm	in	mm	in
6-6S	9,6	0.38	9/16-18	46,0	1.81	27,7	1.09	27,7	1.09
8-8S	12,7	0.50	3/4-16	53,6	2.11	34,5	1.36	34,5	1.36
12-12S	19,0	0.75	1 1/16-12	67,8	2.67	45,2	1.78	45,2	1.78
16-16S	25,4	1.00	1 5/16-12	71,1	2.80	49,3	1.94	49,3	1.94
20-20S	31,7	1.25	1 5/8-12	79,2	3.12	55,1	2.17	55,1	2.17

SAE 37° flare swivel/SAE 37° flare

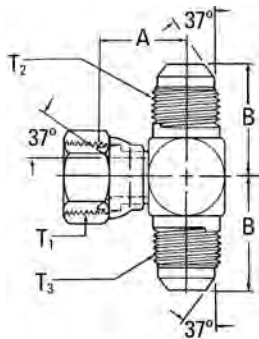

203101-(Dash size) (Ref. SAE 070433)
(Formerly Weatherhead series C5707x)

Dash size	Tube O.D.		Thread T	Thread T2	Thread T3	A		B	
	mm	in				mm	in	mm	in
4-4S	6,3	0.25	7/16-20	7/16-20	7/16-20	16,8	0.66	22,6	0.89
5-5S	7,9	0.31	1/2-20	1/2-20	1/2-20	17,3	0.68	24,1	0.95
6-5S	7,9	0.31	9/16-18	9/16-18	9/16-18	22,4	0.88	26,7	1.05
6-6S	9,6	0.38	9/16-18	9/16-18	9/16-18	22,4	0.88	26,9	1.06
8-8S	12,7	0.50	3/4-16	3/4-16	3/4-16	24,4	0.96	31,8	1.25
10-10S	16,0	0.63	7/8-14	7/8-14	7/8-14	28,4	1.12	36,8	1.45
12-12S	19,0	0.75	1 1/16-12	1 1/16-12	1 1/16-12	30,0	1.18	42,2	1.66
16-16S	25,4	1.00	1 5/16-12	1 5/16-12	1 5/16-12	35,6	1.40	46,0	1.81
20-20S	31,7	1.25	1 5/8-12	1 5/8-12	1 5/8-12	42,7	1.68	52,3	2.06

SAE 37° flare bulkhead/SAE 37° flare

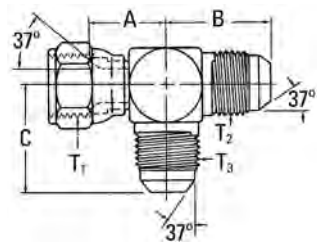

203102-(Dash size) (Ref. SAE 070432)
(Formerly Weatherhead series C5706x)

Dash size	Tube O.D.		Thread T	Thread T2	Thread T3	A		B		C	
	mm	in				mm	in	mm	in	mm	in
4-4S	6,3	0.25	7/16-20	7/16-20	7/16-20	16,8	0.66	22,6	0.89	22,6	0.89
5-5S	7,9	0.31	1/2-20	1/2-20	1/2-20	17,5	0.69	24,1	0.95	24,1	0.95
6-6S	9,6	0.38	9/16-18	9/16-18	9/16-18	22,4	0.88	26,9	1.06	26,9	1.06
8-8S	12,7	0.50	3/4-16	3/4-16	3/4-16	24,4	0.96	31,8	1.25	31,8	1.25
10-10S	16,0	0.63	7/8-14	7/8-14	7/8-14	28,4	1.12	36,8	1.45	36,8	1.45
12-12S	19,0	0.75	1 1/16-12	1 1/16-12	1 1/16-12	30,2	1.19	42,2	1.66	42,2	1.66
16-16S	25,4	1.00	1 5/16-12	1 5/16-12	1 5/16-12	35,8	1.41	46,0	1.81	46,0	1.81
20-20S	31,7	1.25	1 5/8-12	1 5/8-12	1 5/8-12	42,7	1.68	52,3	2.06	52,3	2.06

Steel adapters

SAE 37° flare union

J

SAE 37° flare union

SAE 37° flare

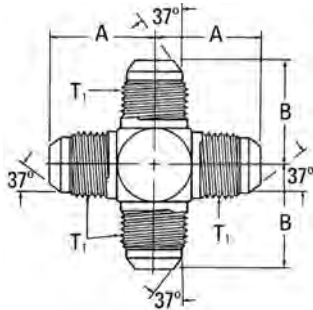

2020-(Dash size) (Ref. SAE 070501)
(Formerly Weatherhead series C5955x)

Dash size	Tube O.D.		Thread T	A		B	
	mm	in		mm	in	mm	in
4-4S	6,3	0.25	7/16-20	22,6	0.89	22,6	0.89
6-6S	9,6	0.38	9/16-18	26,9	1.06	26,9	1.06
8-8S	12,7	0.50	3/4-16	31,8	1.25	31,8	1.25
12-12S	19,0	0.75	1 1/16-12	42,2	1.66	44,2	1.74
16-16S	25,4	1.00	1 5/16-12	46,0	1.81	49,8	1.96

Bulkhead lock nut

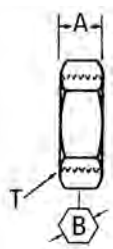

210212-(Dash size) (Ref. SAE 070118)
(Formerly Weatherhead series C5924x)

Dash size	Tube O.D.		Thread T	A		B	
	mm	in		mm	in	mm	in
4S	6,3	0.25	7/16-20	6,4	0.25	17,6	0.69
5S	7,9	0.31	1/2-20	6,4	0.25	19,0	0.75
6S*	9,6	0.38	9/16-18	6,8	0.27	20,6	0.81
8S*	12,7	0.50	3/4-16	7,9	0.31	25,4	1.00
10S	16,0	0.63	7/8-14	9,1	0.36	28,5	1.12
12S*	19,0	0.75	1 1/16-12	10,4	0.41	35,1	1.38
16S	25,4	1.00	1 5/16-12	10,4	0.41	41,1	1.62
20S	31,7	1.25	1 5/8-12	10,4	0.41	47,7	1.88
24S	38,1	1.50	1 7/8-12	10,4	0.41	53,9	2.12

* Also available in stainless steel as part number 259-210212-(dash size).
(Formerly Weatherhead 7936x).

SAE 45° flare union

SAE 45° flare bulkhead/45° flare

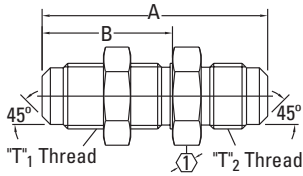

2056-(Dash size)

Dash size	Tube O.D.		Thread T1	Thread T2	A		B		1	
	mm	in			mm	in	mm	in	mm	in
10-10S	16,0	0.63	7/8-14	7/8-14	75,9	2.99	43,9	1.73	28,5	1.12

Note: Available without nut. Order by 2056-1-(dash size).

45° flare/45° flare

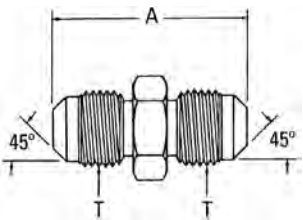

2060-(Dash size) (Ref. SAE 010101)

Dash size	Tube O.D.		Thread T	A	
	mm	in		mm	in
4-4B	6,3	0.25	7/16-20	30,3	1.19
5-5B	7,9	0.31	1/2-20	34,0	1.34
6-6B	9,6	0.38	5/8-18	38,1	1.50
8-8B	12,7	0.50	3/4-16	46,0	1.81
10-10B	16,0	0.63	7/8-14	53,9	2.12
12-12B	19,0	0.75	1 1/16-14	62,0	2.44

WARNING: California Proposition 65, see page A-2.

45° swivel elbow female 45° SAE /male 45° SAE (Steel)

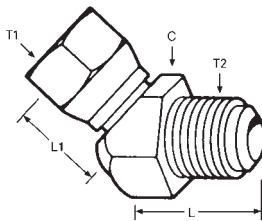

FF4174-(Dash size) (Formerly Weatherhead series 9154x)

Dash size	Tube O.D.		Hex C		L		L1		T1	T2
	mm	in	mm	in	mm	in	mm	in		
0606S	9,7	.38	19,0	.75	35,6	1.40	10,9	.43	5/8-18	5/8-18
0808S	12,7	.50	25,4	1.00	44,7	1.76	15,2	.60	3/4-16	3/4-16
1010S	15,9	.63	31,8	1.25	48,8	1.92	16,4	.65	7/8-14	7/8-14

Steel adapters

SAE O-Ring boss to SAE 37° flare

J

SAE O-Ring boss to SAE 37° flare

SAE O-Ring boss/SAE 37° flare

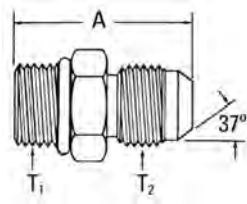

202702-(Dash size) (Ref. SAE 070120)
(Formerly Weatherhead series C5315x)

Dash size	Tube O.D.		Thread T1	Thread T2	A	
	mm	in			mm	in
2-2S	3,3	0.13	5/16-24	5/16-24	26,9	1.06
3-3S	4,8	0.19	3/8-24	3/8-24	27,9	1.10
4-4S*	6,3	0.25	7/16-20	7/16-20	31,2	1.23
4-5S	7,9	0.31	7/16-20	1/2-20	31,2	1.23
4-6S	9,6	0.38	7/16-20	9/16-18	32,3	1.27
4-8S	12,7	0.50	7/16-20	3/4-16	37,8	1.49
5-4S	6,3	0.25	1/2-20	7/16-20	31,2	1.23
5-5S	7,9	0.31	1/2-20	1/2-20	31,2	1.23
5-6S	9,6	0.38	1/2-20	9/16-18	32,3	1.27
6-4S	6,3	0.25	9/16-18	7/16-20	32,8	1.29
6-5S	7,9	0.31	9/16-18	1/2-20	32,8	1.29
6-6S*	9,6	0.38	9/16-18	9/16-18	33,0	1.30
6-8S	12,7	0.50	9/16-18	3/4-16	36,6	1.44
6-10S	16,0	0.63	9/16-18	7/8-14	43,4	1.71
8-4S	6,3	0.25	3/4-16	7/16-20	34,8	1.37
8-5S	7,9	0.31	3/4-16	1/2-20	34,8	1.37
8-6S*	9,6	0.38	3/4-16	9/16-18	35,1	1.38
8-8S*	12,7	0.50	3/4-16	3/4-16	37,6	1.48
8-10S	16,0	0.63	3/4-16	7/8-14	41,7	1.64
8-12S	19,0	0.75	3/4-16	1 1/16-12	49,3	1.94
10-4S	6,3	0.25	7/8-14	7/16-20	37,8	1.49
10-6S	9,6	0.38	7/8-14	9/16-18	38,1	1.50
10-8S	12,7	0.50	7/8-14	3/4-16	40,6	1.60
10-10S	16,0	0.63	7/8-14	7/8-14	43,2	1.70
10-12S	19,0	0.75	7/8-14	1 1/16-12	47,8	1.88
10-16S	25,4	1.00	7/8-14	1 5/16-12	52,6	2.07
12-6S	9,6	0.38	1 1/16-12	9/16-18	42,2	1.66
12-8S	12,7	0.50	1 1/16-12	3/4-16	44,7	1.76
12-10S	16,0	0.63	1 1/16-12	7/8-14	47,2	1.86
12-12S*	19,0	0.75	1 1/16-12	1 1/16-12	50,0	1.97
12-14S	22,3	0.88	1 1/16-12	1 3/16-12	50,5	1.99
12-16S	25,4	1.00	1 1/16-12	1 5/16-12	51,8	2.04
12-20S	31,7	1.25	1 1/16-12	1 5/8-12	58,4	2.30
14-10S	16,0	0.63	1 3/16-12	7/8-14	47,2	1.86
14-12S	19,0	0.75	1 3/16-12	1 1/16-12	49,8	1.96
14-14S	22,3	0.88	1 3/16-12	1 3/16-12	50,5	1.99
14-16S	25,4	1.00	1 3/16-12	1 5/16-12	51,8	2.04
16-8S*	12,7	0.50	1 5/16-12	3/4-16	45,5	1.79
16-10S	16,0	0.63	1 5/16-12	7/8-14	48,0	1.89
16-12S	19,0	0.75	1 5/16-12	1 1/16-12	50,5	1.99
16-16S*	25,4	1.00	1 5/16-12	1 5/16-12	51,8	2.04
16-20S	31,7	1.25	1 5/16-12	1 5/8-12	59,2	2.33
20-12S	19,0	0.75	1 5/8-12	1 1/16-12	52,8	2.08

Note: Also available in stainless steel without O-ring, order 259-202701-(Dash size).

*Also available in stainless steel as 259-202702-(dash size).
(Formerly Weatherhead part number 5327x)

(continued next page)

SAE O-Ring boss to SAE 37° flare

SAE O-Ring boss/SAE 37° flare

(continued from previous page)

202702-(Dash size) Continued (Ref. SAE 070120)
(Formerly Weatherhead series C5315x)

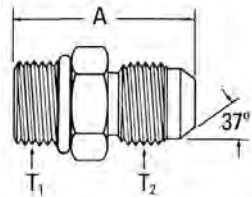

Dash size	Tube O.D.		Thread T1	Thread T2	A	
	mm	in			mm	in
20-16S	25,4	1.00	1 5/8-12	1 5/16-12	53,8	2.12
20-20S	31,7	1.25	1 5/8-12	1 5/8-12	55,1	2.17
20-24S	38,1	1.50	1 5/8-12	1 7/8-12	64,3	2.53
24-16S	25,4	1.00	1 7/8-12	1 5/16-12	55,9	2.20
24-20S	31,7	1.25	1 7/8-12	1 5/8-12	56,9	2.24
24-24S	38,1	1.50	1 7/8-12	1 7/8-12	60,2	2.37
24-32S	50,8	2.00	1 7/8-12	2 1/2-12	74,7	2.94
32-32S	50,8	2.00	2 1/2-12	2 1/2-12	70,6	2.78

Note: Also available in stainless steel without O-ring, order 259-202701-(dash size).

*Also available in stainless steel as 259-202702-(dash size).

(Formerly Weatherhead part number 5327x)

SAE O-Ring boss/SAE 37° flare

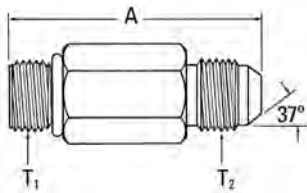

Straight thread O-ring extended connector

202713-(Dash size) (Ref. SAE 070122)
(Formerly Weatherhead series C5316x)

Dash size	Tube O.D.		Thread T1	Thread T2	A	
	mm	in			mm	in
4-4S	6,3	0.25	7/16-20	7/16-20	52,8	2.08
6-6S	9,6	0.38	9/16-18	9/16-18	58,7	2.31
6-8S	12,7	0.50	9/16-18	3/4-16	60,5	2.38
8-8S	12,7	0.50	3/4-16	3/4-16	68,6	2.70
10-10S	16,0	0.63	7/8-14	7/8-14	77,2	3.04
12-12S	19,0	0.75	1 1/16-12	1 1/16-12	91,7	3.61
16-16S	25,4	1.00	1 5/16-12	1 5/16-12	101,1	3.98

SAE O-Ring boss/SAE 37° flare swivel

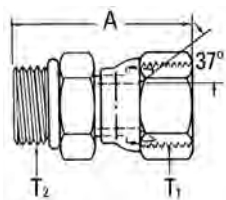

2266-(Dash size)
(Formerly Weatherhead series C5216x)

Dash size	Tube O.D.		Thread T1	Thread T2	A	
	mm	in			mm	in
4-4S	6,4	0.25	7/16-20	7/16-20	32,6	1.28
6-4S	6,3	.025	7/16-20	9/16-18	33,5	1.32
6-6S	9,6	0.38	9/16-18	9/16-18	35,6	1.40
6-8S	12,7	0.50	3/4-16	9/16-18	41,4	1.63
8-6S	9,6	0.38	9/16-18	3/4-16	36,8	1.45
8-8S	12,7	0.50	3/4-16	3/4-16	39,4	1.55
10-10S	16,0	0.63	7/8-14	7/8-14	43,7	1.72
12-12S	19,0	0.75	1 1/16-12	1 1/16-12	48,3	1.90
12-16S	19,0	0.75	1 5/16-12	1 1/16-12	56,6	2.23
16-16S	25,4	1.00	1 5/16-12	1 5/16-12	53,6	2.11
20-20S	31,7	1.25	1 5/8-12	1 5/8-12	64,5	2.54
24-24S	38,1	1.50	1 7/8-12	1 7/8-12	68,3	2.69

Steel adapters

SAE O-Ring boss to SAE 37° flare

J

SAE O-Ring boss to SAE 37° flare

SAE O-Ring boss (adj.)/SAE 37° flare

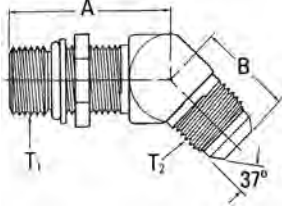

2061-(Dash size) (Ref. SAE 070320)
(Formerly Weatherhead series C5365x)

Dash size	Tube O.D.		Thread T1	Thread T2	A		B	
	mm	in			mm	in	mm	in
4-4S	6,3	0.25	7/16-20	7/16-20	26,7	1.05	18,3	0.72
5-5S	7,9	0.31	1/2-20	1/2-20	26,7	1.05	19,6	0.77
6-4S	6,3	0.25	9/16-18	7/16-20	29,0	1.14	20,8	0.82
6-6S	9,6	0.38	9/16-18	9/16-18	29,0	1.14	21,1	0.83
6-8S	12,7	0.50	9/16-18	3/4-16	30,5	1.20	24,9	0.98
8-6S	9,6	0.38	3/4-16	9/16-18	33,0	1.30	22,1	0.87
8-8S	12,7	0.50	3/4-16	3/4-16	33,0	1.30	24,9	0.98
8-10S	16,0	0.63	3/4-16	7/8-14	34,5	1.36	28,2	1.11
10-8S	12,7	0.50	7/8-14	3/4-16	38,6	1.52	25,1	0.99
10-10S	16,0	0.63	7/8-14	7/8-14	38,6	1.52	28,2	1.11
10-12S	19,0	0.75	7/8-14	1 1/16-12	39,9	1.57	32,5	1.28
12-8S	12,7	0.50	1 1/16-12	3/4-16	43,9	1.73	26,4	1.04
12-10S	16,0	0.63	1 1/16-12	7/8-14	43,9	1.73	29,5	1.16
12-12S	19,0	0.75	1 1/16-12	1 1/16-12	43,9	1.73	32,5	1.28
12-16S	25,4	1.00	1 1/16-12	1 5/16-12	47,2	1.86	37,3	1.47
14-14S	22,3	0.88	1 3/16-12	1 3/16-12	47,2	1.86	36,8	1.45
16-12S	19,0	0.75	1 5/16-12	1 1/16-12	47,2	1.86	36,1	1.42
16-16S	25,4	1.00	1 5/16-12	1 5/16-12	47,2	1.86	37,3	1.47
16-20S	31,7	1.25	1 5/16-12	1 5/8-12	48,5	1.91	40,4	1.59
20-16S	25,4	1.00	1 5/8-12	1 5/16-12	48,5	1.91	39,1	1.54
20-20S	31,7	1.25	1 5/8-12	1 5/8-12	48,5	1.91	40,4	1.59

SAE O-Ring flare (adj.)/SAE 37° flare - Long

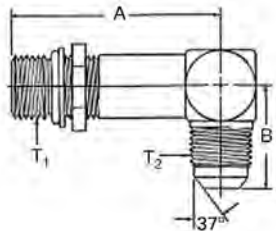

FF3910-(Dash size)
(Formerly Weatherhead series C5515xL)

Dash size	Tube O.D.		Thread T1	Thread T2	A		B	
	mm	in			mm	in	mm	in
6-6S	9,6	0.38	9/16-18	9/16-18	42,2	1.66	26,9	1.06
8-8S	12,7	0.50	3/4-16	3/4-16	45,9	1.81	31,8	1.25
12-12S	19,0	0.75	1 1/16-12	1 1/16-12	62,7	2.47	42,2	1.66

SAE O-Ring flare (adj.)/SAE 37° flare - Extra long

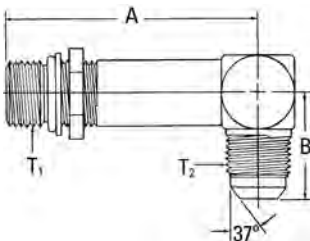

206209-(Dash size)
(Formerly Weatherhead series C5515xLL)

Dash size	Tube O.D.		Thread T1	Thread T2	A		B	
	mm	in			mm	in	mm	in
4-4S	6,3	0.25	7/16-20	7/16-20	43,9	1.73	22,6	0.89
6-6S	9,6	0.38	9/16-18	9/16-18	52,8	2.08	26,9	1.06
8-8S	12,7	0.50	3/4-16	3/4-16	63,0	2.48	31,8	1.25
8-10S	16,0	0.63	3/4-16	7/8-14	64,0	2.52	36,8	1.45
10-10S	16,0	0.63	7/8-14	7/8-14	73,4	2.89	36,8	1.45
12-12S	19,0	0.75	1 1/16-12	1 1/16-12	84,8	3.34	42,2	1.66
16-16S	25,4	1.00	1 5/16-12	1 5/16-12	94,5	3.72	46,0	1.81

SAE O-Ring boss to SAE 37° flare

SAE O-Ring boss (adj.)/SAE 37° flare

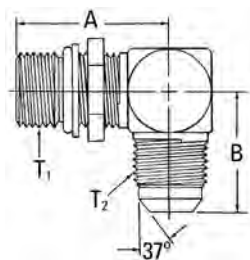

2062-(Dash size) (Ref. SAE 070220)
(Formerly Weatherhead series C5515x)

Dash size	Tube O.D.		Thread T1	Thread T2	A		B	
	mm	in			mm	in	mm	in
4-4S	6,3	0.25	7/16-20	7/16-20	26,2	1.03	22,6	0.89
4-5S	7,9	0.31	7/16-20	1/2-20	28,7	1.13	24,1	0.95
4-6S	9,6	0.38	7/16-20	9/16-18	30,2	1.19	26,9	1.06
5-4S	6,3	0.25	1/2-20	7/16-20	28,7	1.13	24,1	0.95
5-5S	7,9	0.31	1/2-20	1/2-20	28,7	1.13	24,1	0.95
5-6S	9,6	0.38	1/2-20	9/16-18	30,2	1.19	26,9	1.06
6-4S	6,3	0.25	9/16-18	7/16-20	31,8	1.25	26,7	1.05
6-5S	7,9	0.31	9/16-18	1/2-20	31,8	1.25	26,7	1.05
6-6S	9,6	0.38	9/16-18	9/16-18	31,8	1.25	26,9	1.06
6-8S	12,7	0.50	9/16-18	3/4-16	33,5	1.32	31,8	1.25
8-6S	9,6	0.38	3/4-16	9/16-18	36,8	1.45	29,0	1.14
8-8S	12,7	0.50	3/4-16	3/4-16	36,8	1.45	31,8	1.25
8-10S	16,0	0.63	3/4-16	7/8-14	39,1	1.54	36,8	1.45
8-12S	19,0	0.75	3/4-16	1 1/16-12	41,1	1.62	42,2	1.66
10-6S	9,6	0.38	7/8-14	9/16-18	43,2	1.70	31,0	1.22
10-8S	12,7	0.50	7/8-14	3/4-16	43,2	1.70	33,8	1.33
10-10S	16,0	0.63	7/8-14	7/8-14	43,2	1.70	36,8	1.45
10-12S	19,0	0.75	7/8-14	1 1/16-12	45,2	1.78	42,2	1.66
12-8S	12,7	0.50	1 1/16-12	3/4-16	49,3	1.94	36,1	1.42
12-10S	16,0	0.63	1 1/16-12	7/8-14	49,3	1.94	39,1	1.54
12-12S	19,0	0.75	1 1/16-12	1 1/16-12	49,3	1.94	42,2	1.66
12-16S	25,4	1.00	1 1/16-12	1 5/16-12	52,1	2.05	46,0	1.81
12-20S	31,7	1.25	1 1/16-12	1 5/8-12	57,2	2.25	52,3	2.06
14-16S	25,4	1.00	1 3/16-12	1 5/16-12	52,1	2.05	46,0	1.81
16-8S	12,7	0.50	1 5/16-12	3/4-16	52,1	2.05	38,6	1.52
16-10S	16,0	0.63	1 5/16-12	7/8-14	52,1	2.05	41,7	1.64
16-12S	19,0	0.75	1 5/16-12	1 1/16-12	52,1	2.05	44,7	1.76
16-16S	25,4	1.00	1 5/16-12	1 5/16-12	52,1	2.05	46,0	1.81
16-20S	31,7	1.25	1 5/16-12	1 5/8-12	57,2	2.25	52,3	2.06
20-16S	25,4	1.00	1 5/8-12	1 5/16-12	57,2	2.25	51,1	2.01
20-20S	31,7	1.25	1 5/8-12	1 5/8-12	57,2	2.25	52,3	2.06
20-24S	38,1	1.50	1 5/8-12	1 7/8-12	60,7	2.39	59,2	2.33
24-20S	31,7	1.25	1 7/8-12	1 5/8-12	60,7	2.39	55,9	2.20
24-24S	38,1	1.50	1 7/8-12	1 7/8-12	60,7	2.39	59,2	2.33

Steel adapters

SAE O-Ring boss to SAE 37° flare

J

SAE O-Ring boss to SAE 37° flare

SAE O-Ring boss (adj.)/SAE 37° flare

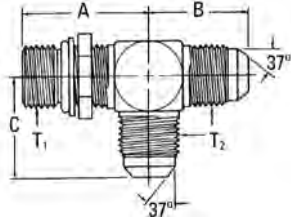

203005-(Dash size) (Ref. SAE 070428)
(Formerly Weatherhead series C5716x)

Dash size	Tube O.D.		Thread T1	Thread T2	A		B		C	
	mm	in			mm	in	mm	in	mm	in
4-4S	6,3	0.25	7/16-20	7/16-20	26,2	1.03	22,6	0.89	22,6	0.89
5-5S	7,9	0.31	1/2-20	1/2-20	28,7	1.13	24,1	0.95	24,1	0.95
6-4-4S	6,3	0.25	9/16-18	7/16-20	31,8	1.25	26,7	1.05	26,7	1.05
6-6S	9,6	0.38	9/16-18	9/16-18	31,8	1.25	26,9	1.06	26,9	1.06
8-8S	12,7	0.50	3/4-16	3/4-16	36,8	1.45	31,8	1.25	31,8	1.25
10-10S	16,0	0.63	7/8-14	7/8-14	43,2	1.70	36,8	1.45	36,8	1.45
12-12S	19,0	0.75	1 1/16-12	1 1/16-12	49,3	1.94	42,2	1.66	42,2	1.66
12-16-16S	25,4	1.00	1 1/16-12	1 5/16-12	52,1	2.05	46,0	1.81	46,0	1.81
16-16S	25,4	1.00	1 5/16-12	1 5/16-12	52,1	2.05	46,0	1.81	46,0	1.81
20-20S	31,7	1.25	1 5/8-12	1 5/8-12	57,2	2.25	52,3	2.06	52,3	2.06

SAE O-Ring boss (adj.)/SAE 37° flare

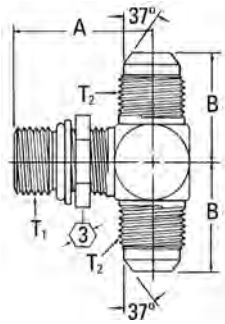

203003-(Dash size) (Ref. SAE 070429)
(Formerly Weatherhead series C5715x)

Dash size	Tube O.D.		Thread T1	Thread T2	A		B	
	mm	in			mm	in	mm	in
4-4S	6,3	0.25	7/16-20	7/16-20	26,2	1.03	22,6	0.89
6-6S	9,6	0.38	9/16-18	9/16-18	31,8	1.25	26,9	1.06
8-8S	12,7	0.50	3/4-16	3/4-16	36,8	1.45	31,8	1.25
10-10S	16,0	0.63	7/8-14	7/8-14	43,2	1.70	36,8	1.45
10-12-12S	19,0	0.95	7/8-14	1 1/16-12	45,2	1.78	42,2	1.66
12-12S	19,0	0.75	1 1/16-12	1 1/16-12	49,3	1.94	42,2	1.66
12-16-16S	25,4	1.00	1 1/16-12	1 5/16-12	52,1	2.05	46,0	1.81
16-16S	25,4	1.00	1 5/16-12	1 5/16-12	52,1	2.05	46,0	1.81
20-20S	31,7	1.25	1 5/8-12	1 5/8-12	57,2	2.25	52,3	2.06

Split flanges

Split flanges

Eaton has standard pressure series (code 61) and high pressure series (code 62) split flange components in kit form that save time in selecting and ordering. Each kit includes two flange halves, four grade-8 hex bolts, four lock washers and an O-Ring. The standard kit has a Buna-N 90 durometer O-Ring that is compatible with petroleum and water-base hydraulic fluids. Optional kits contain EPDM and Viton* O-Ring for applications where fluid compatibility or high temperatures require other than Buna-N O-Ring.

*Viton is a trademark of The Chemours Company FC, LLC.



Two methods can be used to determine the flange dash size and code. The first is by measuring the flange head diameter on the fitting itself. This is referred to as the "K" dimension. The second is by measuring the "A" dimension on the flange or the flange port. Either will determine the dash size and the code since these dimensions are exclusive to either code 61 or code 62 split flange kits. See chart below for these dimensions.

In some cases, split flange fittings are available for hoses which exceed the pressures listed; when ordering fittings or hose assemblies, the terminal end performance rating may reduce the overall rating of the assembly.

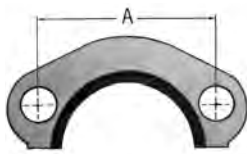

"A" Dim.	"K" Flange head diameter	Flange dash size	Maximum operating pressure*		Recommended bolt torque
			in	psi	
in	in	mm	bar	psi	lb-in
Code 61					
1.50	1.19	-08	350,0	5000	175-225
1.88	1.50	-12	350,0	5000	225-350
2.06	1.75	-16	350,0	5000	325-425
2.31	2.00	-20	280,0	4000	425-550
2.75	2.38	-24	210,0	3000	550-700
3.06	2.81	-32	210,0	3000	650-800
3.50	3.31	-40	175,0	2500	950-1100
4.19	4.00	-48	140,0	2000	1650-1800
Code 62					
1.59	1.25	-08	420,0	6000	175-225
2.00	1.63	-12	420,0	6000	300-400
2.25	1.88	-16	420,0	6000	500-600
2.62	2.12	-20	420,0	6000	750-900
3.12	2.50	-24	420,0	6000	1400-1600
3.81	3.12	-32	420,0	6000	2400-2600

*Per SAE J518 standard.

Assembly procedure

Many leakage problems can be avoided if the split flanges are properly assembled.

To properly assemble

1. Clean all mating surfaces.
2. Lubricate the O-Ring.
3. Partially tighten each bolt in rotation until all are fully tightened to the recommended torque value.

How to order

1. Determine the dash size and the code.
2. Select O-Ring for fluid compatibility.
3. Order by kit number shown on page J-110.

Steel adapters

Split flanges, O-Ring and kits

J

Split flange kits

**SAE standard pressure series
(Code 61) SAE J518**

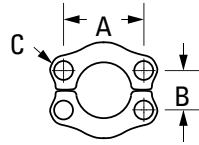
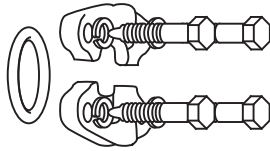

O-Rings material:
Buna-N 90 Durometer
Temperature range:
-40°F to +250°F
(-40°C to + 121°C)

Nominal flange size	Complete kit	*Flange halves 2 required	*Buna-N O-Ring 1 required	*Bolts 4 required	*Lock washer 4 required	A	B	C	Bolt torque lb.-in
1/2	FF593-08	449-74446-8	FF9446-210	FF9442-0520-94	210104-5S	1.50	0.68	0.34	175-225
3/4	FF593-12	449-74446-12	FF9446-214	FF9442-0620-94	210104-6S	1.88	0.88	0.41	250-350
1	FF593-16	449-74446-16	FF9446-219	FF9442-0620-94	210104-2-6S	2.06	1.04	0.41	325-425
1-1/4	FF593-20	449-74446-20	FF9446-222	FF9442-0724-94	210104-7S	2.31	1.18	0.48	425-550
1-1/2	FF593-24	449-74446-24	FF9446-225	FF9442-0824-94	210104-8S	2.75	1.40	0.53	550-700
2	FF593-32	449-74446-32	FF9446-228	FF9442-0824-94	210104-8S	3.06	1.68	0.53	650-800
2-1/2	FF593-40	449-74446-40	FF9446-232	FF9442-0828-94	210104-8S	3.50	2.00	0.53	950-1100
3	FF593-48	449-74446-48	FF9446-237	FF9442-1028-94	210104-10S	4.19	2.44	0.66	1650-1800

* Included in kit.

*Viton kit available as part number FF687-Size. EPDM kit available as part number FF688-size. See page J-111 for Viton and EPDM O-Ring part numbers.

Note: All measurements in inches.

**SAE high pressure series
(Code 62) SAE J518**

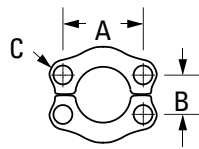
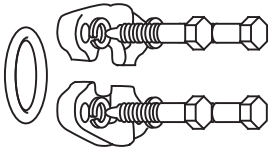

O-Ring material:
Buna-N 90 Durometer
Temperature range:
-40°F to +250°F
(-40°C to + 121°C)

Note: Code 62 split flange kits cannot be used with Cat flange fittings. Use existing split flanges.

Nominal flange size	Complete kit	*Flange halves 2 required	*Buna-N O-Ring 1 required	*Bolts 4 required	*Lock washer 4 required	A	B	C	Bolt torque lb.-in
3/4	FF595-12	FC3425-12-449	FF9446-214	FF9442-0624-94	210104-6S	2.00	0.94	0.42	300-400
1	FF595-16	FC3425-16-449	FF9446-219	FF9442-0728-94	210104-7S	2.25	1.10	0.50	500-600
1-1/4	FF595-20	FC3425-20-449	FF9446-222	FF9442-0828-94	210104-8S	2.62	1.24	0.60	750-900
1-1/2	FF595-24	FC3425-24-449	FF9446-225	FF9442-1036-94	210104-10S	3.12	1.44	0.66	1400-1600
2	FF595-32	FC3425-32-449	FF9446-228	FF9442-1244-94	210104-12S	3.81	1.76	0.78	2400-2600

* Included in kit.

* Viton kit available as part number FF689-size. See Page J-111 for Viton O-Ring part numbers.

Note: All measurements in inches.

Viton is a trademark of The Chemours Company FC, LLC.

Split flange kits

4 hole flange SAE standard pressure series (Code 61) SAE J518

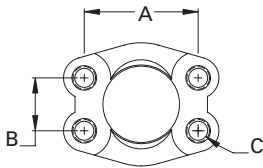

Nominal flange size	4 bolt flange	A	B	C (Threaded)
3/4	FC2119-12-449	1.88	0.88	3/8-16
1	FC2119-16-449	2.06	1.03	7/16-14
1-1/4	FC2119-20-449	2.31	1.19	3/8-16
1-1/2	FC2119-24-449	2.75	1.41	1/2-13
2	FC2119-32-449	3.06	1.69	1/2-13
2-1/2	FC2119-40-449	3.50	2.00	1/2-13

*Available without threads as part number FC3459-size-449.

Note: All measurements in inches.

O-Ring for SAE J518 Split flange

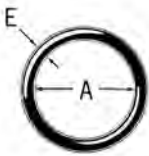

O-Ring base number	Material	Operating temperature range
FF9016 EPDM	80 Durometer	-65°F to +300°F (-55°C to +150°C)
FF9446 Buna-N	90 Durometer Buna-N	-40°F to +250°F (-40°C to +121°C)
22046 Viton	90 Durometer	-15°F to +400°F (-25°C to +205°C)

O-Ring dash size designation	Flange dash size	Nominal flange size	A		E	
			mm	in	mm	in
-210	08	1/2	18,5	0.734	3,5	0.139
-214	12	3/4	24,9	0.984	3,5	0.139
-219	16	1	32,9	1.296	3,5	0.139
-222	20	1 1/4	37,7	1.484	3,5	0.139
-225	24	1 1/2	47,2	1.859	3,5	0.139
-228	32	2	56,7	2.234	3,5	0.139
-232	40	2 1/2	69,4	2.734	3,5	0.139
-237	48	3	85,3	3.359	3,5	0.139

Viton is a trademark of The Chemours Company FC, LLC.

Steel adapters

Split flanges, O-Ring and kits

J

O-Rings and kits

O-Ring seal kit FF16087-01

Includes: metal box,
O-Rings for ORS -4 through -24,
O-Ring boss -04 through -32,
Split flange -08 through -32,
24 packages with twelve
90 durometer nitrile
O-Ring per package.
Replacement O-Ring can be
ordered individually by
part number listed.



FF16087-01

Connection	Size	Individual O-Ring part no.
ORS	-04	FF9446-11
ORS	-06	FF9446-12
ORS	-08	FF9446-14
ORS	-10	FF9446-16
ORS	-12	FF9446-18
ORS	-16	FF9446-21
ORS	-20	FF9446-25
ORS	-24	FF9446-29
O-Ring Boss	-04	22617-4
O-Ring Boss	-05	22617-5
O-Ring Boss	-06	22617-6
O-Ring Boss	-08	22617-8
O-Ring Boss	-10	22617-10
O-Ring Boss	-12	22617-12
O-Ring Boss	-16	22617-16
O-Ring Boss	-20	22617-20
O-Ring Boss	-24	22617-24
O-Ring Boss	-32	22617-32
Split Flange	-08	FF9446-210
Split Flange	-12	FF9446-214
Split Flange	-16	FF9446-219
Split Flange	-20	FF9446-222
Split Flange	-24	FF9446-225
Split Flange	-32	FF9446-228

BSPB bonded seal for DIN 3852-2 ports

FF9895

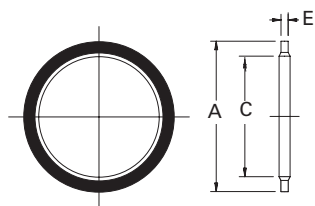

Bonded seal part number	BSPB thread size	A Ref	C Ref	E Ref
		inch	inch	inch
FF9895-02	1/8-28	0.625	0.403	0.080
FF9895-04	1/4-19	0.810	0.536	0.080
FF9895-06	3/8-19	0.937	0.675	0.080
FF9895-08	1/2-14	1.125	0.843	0.097
FF9895-10	5/8-14	1.250	0.920	0.097
FF9895-12	3/4-14	1.375	1.060	0.097
FF9895-16	1-11	1.685	1.329	0.133
FF9895-20	1 1/4-11	2.062	1.685	0.133
FF9895-24	1 1/2-11	2.307	1.902	0.133
FF9895-32	2-11	2.875	2.380	0.133

Material: Steel with bonded Nitrile (Buna-N) seal.

Designating separate SAE O-Ring boss

To order Eaton O-Ring separately without fittings specify the size and material by using the O-Ring base number and dash size. The charts offer a simple method to assure the correct O-Ring for your application.

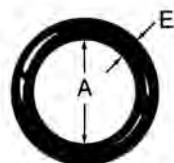

O-Ring base no.	Material	Operating temperature range
22617 (Standard)	Buna-N Nitrile rubber 90 Durometer	-30°F to +250°F (-34°C to +121°C)
22033	EPDM Ethylene propylene diene monomer	-65°F to +212°F (-55°C to +100°C)
22068	Viton Fluoroelastomer 90 Durometer	-15°F to +400°F (-25°C to +205°C)
22012	Buna-N, Low temperature nitrile rubber 90 Durometer	-65°F to +225°F (-55°C to +107°C)

O-Ring dash size	Tube size	A		E	
		mm	in	mm	in
-4	-04 (1/4)	8,9	0.351	1,8	0.072
-6	-06 (3/8)	11,9	0.468	2,0	0.078
-8	-08 (1/2)	16,3	0.644	2,3	0.087
-10	-10 (5/8)	19,3	0.755	2,5	0.097
-12	-12 (3/4)	23,4	0.924	3,0	0.116
-16	-16 (1)	29,7	1.171	3,0	0.116
-20	-20 (1 1/4)	37,6	1.475	3,0	0.118
-24	-24 (1 1/2)	43,7	1.720	3,0	0.118

Designating separate ORS O-Ring

To order Eaton O-Ring separately without fittings specify the size and material by using the O-Ring designator and O-Ring base number. The charts to the right offer a simple method to assure the correct O-Ring for your application.

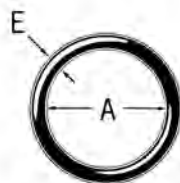

O-Ring base no.	Material	Operating temperature range
FF9446 (Standard)	Buna-N Nitrile Rubber 90 Durometer	-40°F to +250°F (-40°C to +121°C)
FF9807	EPDM Ethylene propylene diene monomer	-65°F to +300°F (-55°C to +150°C)
22046	Viton Fluoroelastomer 90 Durometer	-15°F to +400°F (-25°C to +205°C)
FF9855	Buna-N, Low Temperature Nitrile Rubber 90 Durometer	-65°F to +225°F (-55°C to +107°C)
22546	Neoprene 90 Durometer	-65°F to +300°F (-55°C to +150°C)

O-Ring dash size	Tube size	A		E	
		mm	in	mm	in
-11	-04	7,6	0.301	1,8	0.07
-12	-06	9,2	0.364	1,8	0.07
-14	-08	12,4	0.489	1,8	0.07
-16	-10	15,6	0.614	1,8	0.07
-18	-12	18,8	0.739	1,8	0.07
-21	-16	23,5	0.926	1,8	0.07
-25	-20	29,9	1.176	1,8	0.07
-29	-24	37,8	1.489	1,8	0.07

Viton is a trademark of The Chemours Company FC, LLC.

Steel adapters

SAE split flange to ORS

J

SAE split flange to ORS

ORS/split flange (Code 62)

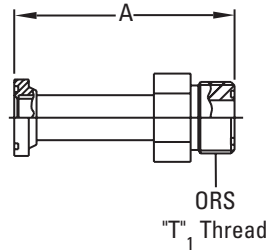

FF5943T(Dash size)

Dash size	Tube O.D.		Thread T1	A	
	mm	in		mm	in
1212S	19,0	0.75	1 3/16-12	77,7	3.06
1616S	25,4	1.00	1 7/16-12	90,7	3.57

45° ORS/split flange (Code 61)

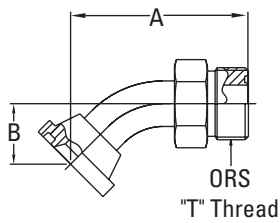

FF6001T(Dash size)

Dash size	Tube O.D.		Thread T	A		B	
	mm	in		mm	in	mm	in
1216S	19,0	0.75	1 3/16-12	74,7	2.94	25,4	1.00

45° ORS/split flange (Code 62)

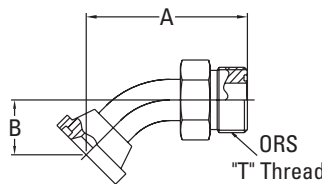

FF6002T(Dash size)

Dash size	Tube O.D.		Thread T	A		B	
	mm	in		mm	in	mm	in
1212S	19,0	0.75	1 3/16-12	74,7	2.94	25,4	1.00
1616S	25,4	1.00	1 7/16-12	86,6	3.41	26,9	1.06

SAE split flange to ORS

90° ORS/split flange (Code 61)

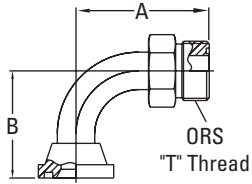

FF5946T(Dash size)

Dash size	Tube O.D.		Thread T	A		B	
	mm	in		mm	in	mm	in
1212S	19,0	0.75	1 3/16-12	67,3	2.65	54,1	2.13
1216S	19,0	0.75	1 3/16-12	67,3	2.65	54,1	2.13
1616S	25,4	1.00	1 7/16-12	81,8	3.22	60,2	2.37
2020S	31,7	1.25	1 11/16-12	88,1	3.47	66,5	2.62
2424S	38,1	1.50	2-12	100,8	3.97	79,2	3.12

90° ORS/split flange (Code 62)

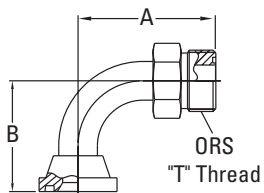

FF5945T(Dash size)

Dash size	Tube O.D.		Thread T	A		B	
	mm	in		mm	in	mm	in
1212S	19,0	0.75	1 3/16-12	67,3	2.65	54,1	2.13
1612S	25,4	1.00	1 7/16-12	67,3	2.65	54,1	2.13
1616S	25,4	1.00	1 7/16-12	81,8	3.22	60,2	2.37
1620S	25,4	1.00	1 7/16-12	88,1	3.47	66,5	2.62
2020S	31,7	1.25	1 11/16-12	88,1	3.47	66,5	2.62
2424S	38,1	1.50	2-12	100,8	3.97	79,2	3.12

90° ORS/split flange (Code 62)

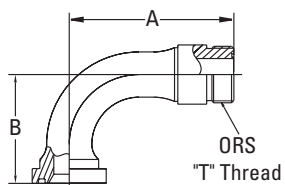

FF6062T(Dash size)

Dash size	Tube O.D.		Thread T	A		B	
	mm	in		mm	in	mm	in
1616S	25,4	1.00	1 7/16-12	105,9	4.17	70,1	2.76

ORS/split flange (Code 62)

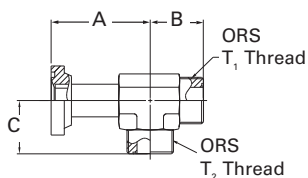

FF2522T(Dash size)

Dash size	Tube O.D.		Thread T1	Thread T2	A		B		C	
	mm	in			mm	in	mm	in	mm	in
1624S	38,1	1.50	1 7/16-12	1 7/16-12	77,8	3.06	41,7	1.64	41,7	1.64

Steel adapters

SAE split flange to SAE 37° flare

J

SAE split flange to SAE 37° flare

Split flange/SAE 37° flare
Standard pressure series (Code 61)

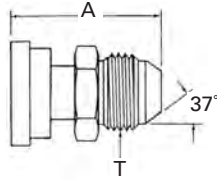

500025-(Dash size) (mates with 449-74446 flanges)
(Formerly Weatherhead 500 series)

The performance rating of these adapters is the lower of the two terminal ends. These adapters are rated to JIC pressures as specified in SAE J514.

Dash size	Split flange size	Tube O.D.		Thread T	A	
		mm	in		mm	in
8S	1/2	12,7	0.50	3/4-16	42,2	1.66
12S	3/4	19,0	0.75	1 1/16-12	48,5	1.91
12-8S	3/4	12,7	0.50	3/4-16	51,6	2.03
16S	1	25,4	1.00	1 5/16-12	51,1	2.01
16-10S	1	16,0	0.63	7/8-14	47,2	1.86
16-12S	1	19,0	0.75	1 1/16-12	58,4	2.30
20S	1 1/4	31,7	1.25	1 5/8-12	62,5	2.46
20-16S	1 1/4	25,4	1.00	1 5/16-12	59,7	2.35
20-24S	1 1/4	38,1	1.50	1 7/8-12	67,0	2.64
24S	1 1/2	38,1	1.50	1 7/8-12	68,8	2.71
24-16S	1 1/2	25,4	1.00	1 5/16-12	61,2	2.41
24-20S	1 1/2	31,7	1.25	1 5/8-12	62,5	2.46
32-16S	2	25,4	1.00	1 5/16-12	58,9	2.32
32-20S	2	31,7	1.25	1 5/8-12	64,0	2.52
32-24S	2	38,1	1.50	1 7/8-12	68,8	2.71
40-24S	2 1/2	38,1	1.50	1 7/8-12	70,4	2.77

Split flange/SAE 37° flare
Standard pressure series (Code 61) -
Long adapter

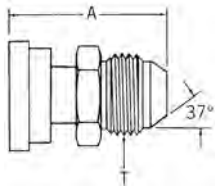

FF5239-(Dash size) (mates with 449-74446 flanges)
(Formerly Weatherhead 500 series)

The performance rating of these adapters is the lower of the two terminal ends. These adapters are rated to JIC pressures as specified in SAE J514.

Dash size	Split flange size	Tube O.D.		Thread T	A	
		mm	in		mm	in
3232S	2	50,8	2.00	2 1/2-12	143,0	5.63

Split flange/SAE 37° flare
Standard pressure series (Code 62)

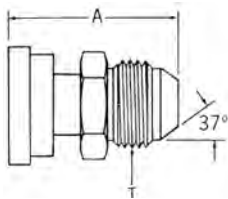

FF5541-(Dash size) (mates with FC3425- size-449 flanges)
(Formerly Weatherhead 600 series)

The performance rating of these adapters is the lower of the two terminal ends. These adapters are rated to JIC pressures as specified in SAE J514.

Dash size	Split flange size	Tube O.D.		Thread T	A	
		mm	in		mm	in
1212S	3/4	19,0	0.75	1 1/16-12	80,5	3.17
1616S	1	25,4	1.00	1 5/16-12	95,5	3.76
2016S	1 1/4	25,4	1.00	1 5/16-12	95,5	3.76
2020S	1 1/4	31,7	1.25	1 5/8-12	97,5	3.84
2416S	1 1/2	25,4	1.00	1 5/16-12	95,5	3.76
2420S	1 1/2	31,7	1.25	1 5/8-12	97,5	3.84
2424S	1 1/2	38,1	1.50	1 7/8-12	118,6	4.67

SAE split flange to SAE 37° flare

Split flange/SAE 37° flare Standard pressure series (Code 62) - Long adapter

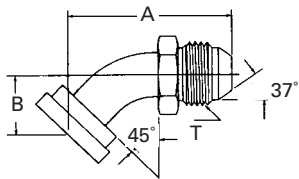

FF5539-(Dash size) (mates with FC3425-size-449 flanges)
(Formerly Weatherhead 645 series)

The performance rating of these adapters is the lower of the two terminal ends. These adapters are rated to JIC pressures as specified in SAE J514.

Dash size	Split flange size	Tube O.D.		Thread T	A		B	
		mm	in		mm	in	mm	in
12-12S	3/4	19,0	0.75	1 1/16-12	79,8	3.14	25,9	1.02
1612S	1	19,0	0.75	1 1/16-12	78,5	3.09	25,4	1.00
1616S	1	25,4	1.00	1 5/16-12	91,4	3.60	26,9	1.06
2016S	1 1/4	25,4	1.00	1 5/16-12	91,4	3.60	26,9	1.06
2020S	1 1/4	31,7	1.25	1 5/8-12	98,0	3.86	29,2	1.15
2416S	1 1/2	25,4	1.00	1 5/16-12	103,1	4.06	31,8	1.25
2420S	1 1/2	31,7	1.25	1 5/8-12	98,0	3.86	29,2	1.15
2424S	1 1/2	38,1	1.50	1 7/8-12	117,1	4.61	35,8	1.41

Split flange/SAE 37° flare Standard pressure series (Code 61)

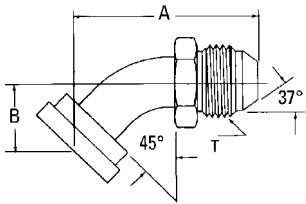

500023-(Dash size) (mates with 449-74446 flanges)
(Formerly Weatherhead 545 series)

The performance rating of these adapters is the lower of the two terminal ends. These adapters are rated to JIC pressures as specified in SAE J514.

Dash size	Split flange size	Tube O.D.		Thread T	A		B	
		mm	in		mm	in	mm	in
8S	1/2	12,7	0.50	3/4-16	59,4	2.34	25,4	1.00
12S	3/4	19,0	0.75	1 1/16-12	70,3	2.77	25,7	1.01
12-8S	3/4	12,7	0.50	3/4-16	59,4	2.34	25,4	1.00
16S	1	25,4	1.00	1 5/16-12	77,2	3.04	28,7	1.13
16-10S	1	16,0	0.63	7/8-14	65,5	2.58	25,4	1.00
16-12S	1	19,0	0.75	1 1/16-12	70,3	2.77	25,7	1.01
16-20S	1	31,7	1.25	1 5/8-12	82,4	3.25	28,5	1.13
20-12S	1 1/4	19,0	0.75	1 1/16-12	70,3	2.77	25,7	1.01
20-16S	1 1/4	25,4	1.00	1 5/16-12	77,2	3.04	28,7	1.13
24-16S	1 1/2	25,4	1.00	1 5/16-12	78,2	3.08	29,7	1.17
24-20S	1 1/2	31,7	1.25	1 5/8-12	82,3	3.24	28,5	1.12
24-32S	1 1/2	50,8	2.00	2 1/2-12	99,3	3.91	28,5	1.12
40S	2 1/2	63,5	2.50	3-12	131,6	5.18	42,2	1.66
40-24S	2 1/2	38,1	1.50	1 7/8-12	90,9	3.58	29,7	1.17

Split flange/SAE 37° flare Standard pressure series (Code 61) - Long adapter

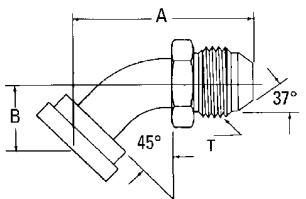

FF5238-(Dash size) (mates with 449-74446 flanges)
(Formerly Weatherhead 545 series)

The performance rating of these adapters is the lower of the two terminal ends. These adapters are rated to JIC pressures as specified in SAE J514.

Dash size	Split flange size	Tube O.D.		Thread T	A		B	
		mm	in		mm	in	mm	in
1212S	3/4	19,0	0.75	1 1/16-12	78,5	3.09	25,4	1.00
1616S	1	25,4	1.00	1 5/16-12	91,4	3.60	26,9	1.06
1620S	1	31,7	1.25	1 5/8-12	92,6	3.64	26,9	1.06
2020S	1 1/4	31,7	1.25	1 5/8-12	98,0	3.86	29,2	1.15
2420S	1 1/2	31,7	1.25	1 5/8-12	98,0	3.86	35,8	1.41
2424S	1 1/2	38,1	1.50	1 7/8-12	117,1	4.61	35,8	1.41
3232S	2	50,8	2.00	2 1/2-12	153,4	6.04	50,8	2.00

Steel adapters

SAE split flange to SAE 37° flare

J

SAE split flange to SAE 37° flare

Split flange/SAE 37° flare
Standard pressure series (Code 61)

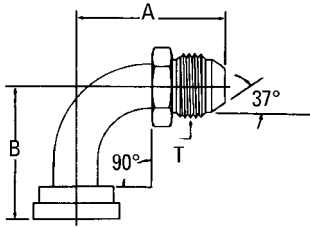

500024-(Dash size) (mates with 449-74446 flanges)
(Formerly Weatherhead 590 series)

The performance rating of these adapters is the lower of the two terminal ends.
These adapters are rated to JIC pressures as specified in SAE J514.

Dash size	Split flange size	Tube O.D.		Thread T	A		B	
		mm	in		mm	in	mm	in
8S	1/2	12,7	0.50	3/4-16	45,2	1.78	41,1	1.62
12-8S	3/4	12,7	0.50	3/4-16	45,2	1.78	41,1	1.62
12-10S	3/4	16,0	0.63	7/8-14	60,4	2.38	54,6	2.15
16-10S	1	16,0	0.63	7/8-14	54,9	2.16	53,9	2.12
16-12S	1	19,0	0.75	1 1/16-12	63,2	2.49	54,6	2.15
20-12S	1 1/4	19,0	0.75	1 1/16-12	63,2	2.49	54,6	2.15
20-24S	1 1/4	38,1	1.50	1 7/8-12	90,9	3.58	68,3	2.69
24-16S	1 1/2	25,4	1.00	1 5/16-12	70,9	2.79	62,0	2.44
24-20S	1 1/2	31,7	1.25	1 5/8-12	79,7	3.14	63,5	2.50
24-32S	1 1/2	50,8	2.00	1 7/8-12	100,4	3.95	69,8	2.75
32-20S	2	31,7	1.25	1 5/8-12	79,7	3.14	65,0	2.56
32-24S	2	38,1	1.50	1 7/8-12	90,9	3.58	69,8	2.75
40-24S	2 1/2	38,1	1.50	1 7/8-12	90,9	3.58	71,4	2.81
40-32S	2 1/2	50,8	2.00	2 1/2-12	113,3	4.46	84,1	3.31
40-40S	2 1/2	63,5	2.50	3-12	148,8	5.86	131,8	5.19

Split flange/SAE 37° flare
Standard pressure series (Code 61)

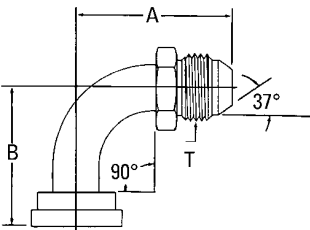

FF5162-(Dash size) (mates with 449-74446 flanges)
(Formerly Weatherhead 590 series)

The performance rating of these adapters is the lower of the two terminal ends.
These adapters are rated to JIC pressures as specified in SAE J514.

Dash size	Split flange size	Tube O.D.		Thread T	A		B	
		mm	in		mm	in	mm	in
0808S	1/2	12,7	0.50	3/4-16	54,9	2.16	41,1	1.62
1212S	3/4	19,0	0.75	1 1/16-12	71,4	2.81	54,1	2.13
1612S	1	19,0	0.75	1 1/16-12	71,4	2.81	54,1	2.13
1616S	1	25,4	1.00	1 5/16-12	86,6	3.41	60,4	2.38
1620S	1	31,7	1.25	1 5/8-12	87,9	3.46	60,4	2.38
2016S	1 1/4	25,4	1.00	1 5/16-12	86,6	3.41	60,4	2.38
2020S	1 1/4	31,7	1.25	1 5/8-12	94,2	3.71	66,5	2.62
2416S	1 1/2	25,4	1.00	1 5/16-12	86,6	3.41	60,4	2.38
2420S	1 1/2	31,7	1.25	1 5/8-12	94,2	3.71	66,5	2.62
2424S	1 1/2	38,1	1.50	1 7/8-12	110,0	4.33	79,2	3.12
3232S	2	50,8	2.00	2 1/2-12	145,0	5.71	114,3	4.50

SAE split flange to SAE 37° flare

Split flange/SAE 37° flare High pressure series (Code 62)

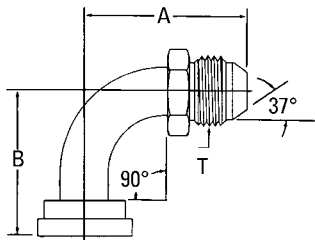

FF5540-(Dash size) (mates with FC3425 - size-449 flanges)

The performance rating of these adapters is the lower of the two terminal ends. These adapters are rated to JIC pressures as specified in SAE J514.

Dash size	Split flange size	Tube O.D.		Thread T	A		B	
		mm	in		mm	in	mm	in
1212S	3/4	19,0	0.75	1 1/16-12	71,4	2.81	54,1	2.13
1612S	1	19,0	0.75	1 1/16-12	71,4	2.81	54,1	2.13
1616S	1	25,4	1.00	1 5/16-12	86,6	3.41	60,4	2.38
2020S	1 1/4	31,7	1.25	1 5/8-12	94,2	3.71	66,5	2.62
2416S	1 1/2	25,4	1.00	1 5/16-12	86,6	3.41	69,8	2.75
2420S	1 1/2	31,7	1.25	1 5/8-12	94,2	3.71	66,5	2.62
2424S	1 1/2	38,1	1.50	1 7/8-12	110,0	4.33	79,2	3.12

SAE swivel flange to SAE split flange

SAE swivel flange/split flange SAE Standard pressure series (Code 61)

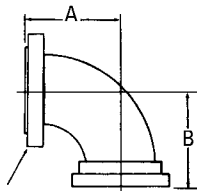

504089-(Dash size)

(suitable for pressures through SAE 100R16 2 wire braid hose)

Dash size	Shoulder size	Flange size	A		B	
			mm	in	mm	in
16S	1	1	52,3	2.06	60,2	2.37
20S	1 1/4	1 1/4	58,7	2.31	63,5	2.50
24S	1 1/2	1 1/2	66,5	2.62	69,8	2.75
32S	2	2	79,2	3.12	82,5	3.25
40S	2 1/2	2 1/2	119,1	4.69	131,8	5.19

SAE swivel flange/split flange SAE Standard pressure series (Code 61)

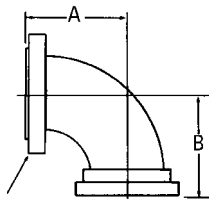

FF5321-(Dash size)

(suitable for pressures through SAE 100R12 4 spiral hose)

Dash size	Shoulder size	Flange size	A		B	
			mm	in	mm	in
1616S	1	1	60,4	2.38	60,4	2.38
2020S	1 1/4	1 1/4	66,5	2.62	66,5	2.62
2424S	1 1/2	1 1/2	79,2	3.12	79,2	3.12
3232S	2	2	114,3	4.50	114,3	4.50

Steel adapters

SAE flareless to SAE 37° union

J

SAE flareless to SAE 37° union

Male SAE flareless/SAE 37° flare*

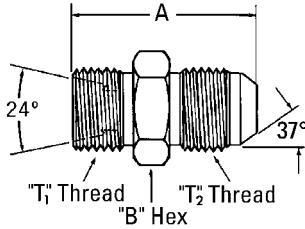

FF1315-(Dash size)

Dash size	Tube O.D.		Thread T1	Thread T2	A		B	
	mm	in			mm	in	mm	in
0404S	6,3	0.25	7/16-20	7/16-20	31,0	1.22	12,7	0.50
0604S	9,6	0.38	9/16-18	7/16-20	32,3	1.27	15,7	0.62
0606S	9,6	0.38	9/16-18	9/16-18	32,5	1.28	15,7	0.62
0806S	12,7	0.50	3/4-16	9/16-18	34,8	1.37	20,6	0.81
0808S	12,7	0.50	3/4-16	3/4-16	37,3	1.47	20,6	0.81
1008S	16,0	0.63	7/8-14	3/4-16	40,4	1.59	23,9	0.94
1010S	16,0	0.63	7/8-14	7/8-14	42,9	1.69	23,9	0.94
1212S	19,0	0.75	1 1/16-12	1 1/16-12	49,0	1.93	28,5	1.12
1616S	25,4	1.00	1 5/16-12	1 5/16-12	50,3	1.98	35,1	1.38

Flareless tube nut*

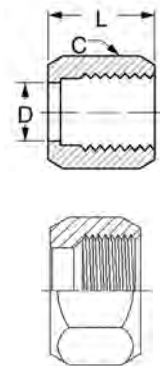

210294-(Dash size)

Use with FF1315-(Dash size) body only
(Ref. SAE 080110)

Dash size	Tube O.D.		Thread T	A		B	
	mm	in		mm	in	mm	in
4S	6,3	0.25	7/16-20	17,8	0.70	14,2	0.56
6S	9,6	0.38	9/16-18	19,0	0.75	17,6	0.69
8S	12,7	0.50	3/4-16	21,3	0.84	22,4	0.88
10S	16,0	0.63	7/8-14	23,4	0.92	25,4	1.00
12S	19,0	0.75	1 1/16-12	24,6	0.97	31,8	1.25
14S	22,3	0.88	1 3/16-12	25,4	1.00	35,1	1.38
16S	25,4	1.00	1 5/16-12	26,7	1.05	38,1	1.50

Ferrule-style A*
(for flareless tube fittings)

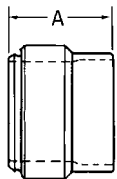

FF9173-(Dash size)

Use with FF1315-(Dash size) body only
(Ref. SAE 080115A)

Dash size	Tube O.D.		A	
	mm	in	mm	in
04S	6,3	0.25	9,1	0.36
06S	9,6	0.38	9,9	0.39
08S	12,7	0.50	10,9	0.43
10S	16,0	0.63	11,2	0.44
12S	19,0	0.75	11,9	0.47
16S	25,4	1.00	12,2	0.48

Note: *All three components (adapter FF1315, tube nut 210294 and ferrule FF9173) required for assembly. Order by Part Number FF1316-(dash size) for complete assembly.

Brace and weld to split flange

Brace/solid flanged head SAE
Standard pressure series (Code 61)

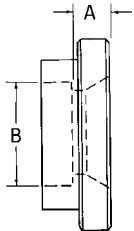

71418-(Dash size)

Dash size	Split flange size	Tube O.D.		A		B	
		mm	in	mm	in	mm	in
12-12S	3/4	19,0	0.75	7,9	0.31	19,0	0.75
16-12S	3/4	25,4	1.00	7,9	0.31	25,4	1.00
16-16S	1	25,4	1.00	7,9	0.31	25,4	1.00
20-20S	1 1/4	31,7	1.25	7,9	0.31	31,8	1.25
24-24S	1 1/2	38,1	1.50	9,7	0.38	38,1	1.50
32-32S	2	50,8	2.00	9,7	0.38	50,8	2.00
40-40S	2 1/2	63,5	2.50	11,2	0.44	63,5	2.50

Brace/(flanged head) SAE
Standard pressures series (Code 61)

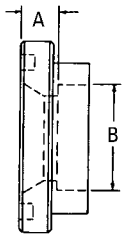

4624-(Dash size)

Dash size	Split flange size	Tube O.D.		A		B	
		mm	in	mm	in	mm	in
12S	3/4	19,0	0.75	7,9	0.31	19,0	0.75
12-16S	3/4	25,4	1.00	7,9	0.31	25,4	1.00
16S	1	25,4	1.00	7,9	0.31	25,4	1.00
16-12S	1	19,0	0.75	7,9	0.31	19,0	0.75
16-20S	1	31,7	1.25	7,9	0.31	31,8	1.25
20S	1 1/4	31,7	1.25	7,9	0.31	31,8	1.25
20-16S	1 1/4	25,4	1.00	7,9	0.31	25,4	1.00
24S	1 1/2	38,1	1.50	9,7	0.38	38,1	1.50
24-16S	1 1/2	25,4	1.00	9,7	0.38	25,4	1.00
24-20S	1 1/2	31,7	1.25	7,9	0.31	31,8	1.25
32S	2	50,8	2.00	9,7	0.38	50,8	2.00
32-16S	2	25,4	1.00	7,1	0.28	25,4	1.00
32-24S	2	38,1	1.50	9,7	0.38	38,1	1.50
40-32S	2 1/2	50,8	2.00	11,2	0.44	50,8	2.00

Steel adapters

Braze and weld to split flange

J

Braze and weld to split flange

Buttweld (pipe)/solid flanged head SAE
Standard pressure series (Code 61)

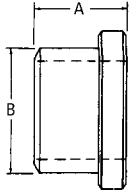

71416-(Dash size)

Dash size	Flange size	A		B	
		mm	in	mm	in
16S	1	27,4	1.08	33,6	1.32
20S	1 1/4	27,4	1.08	42,2	1.66
24S	1 1/2	29,0	1.14	48,3	1.90
32S	2	29,0	1.14	60,4	2.38

Saddle weld (pipe)/solid flanged head SAE
Standard pressure series (Code 61)

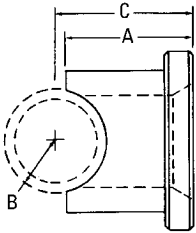

71422-(Dash size)

Dash size	Flange size	A		B		C	
		mm	in	mm	in	mm	in
20-20S	1 1/4	32,3	1.27	21,0	0.83	44,9	1.77

Braze/(flanged head) SAE
High pressure series (Code 62)

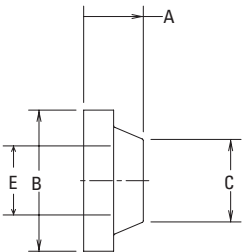

FC1102-(Dash size)

Dash size	Tube O.D.		A		B		C		E	
	mm	in	mm	in	mm	in	mm	in	mm	in
0808S	12,7	0.50	15,7	0.62	31,7	1.25	17,8	0.70	9,9	0.39
1208S	12,7	0.50	15,7	0.62	41,4	1.63	24,1	0.95	9,9	0.39
1212S	19,0	0.75	17,5	0.69	41,4	1.63	24,1	0.95	14,7	0.58
1612S	25,4	1.00	17,5	0.69	47,7	1.88	31,5	1.24	14,7	0.58
1616S	25,4	1.00	15,7	0.62	47,7	1.88	31,5	1.24	20,8	0.82
2012S	31,7	1.25	15,7	0.62	54,1	2.13	38,3	1.51	19,0	0.75
2016S	31,7	1.25	15,7	0.62	54,1	2.13	38,3	1.51	20,8	0.82
2020S	31,7	1.25	15,7	0.62	54,1	2.13	38,1	1.50	26,7	1.05
2416S	38,1	1.50	15,7	0.62	63,5	2.50	46,5	1.83	20,8	0.82
2420S	38,1	1.50	15,7	0.62	63,5	2.50	46,5	1.83	26,7	1.05
2424S	38,1	1.50	19,0	0.75	63,5	2.50	46,5	1.83	32,2	1.27
3224S	50,8	2.00	19,0	0.75	79,5	3.13	63,0	2.48	32,2	1.27
3232S	50,8	2.00	28,4	1.12	79,5	3.13	58,7	2.31	43,7	1.72

Braze/solid flanged head SAE
High pressure series (Code 62)

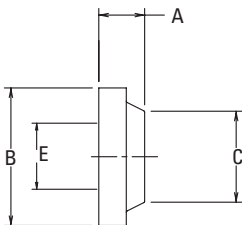

FC1132-(Dash size)

Dash size	Tube O.D.		A		B		C		E	
	mm	in	mm	in	mm	in	mm	in	mm	in
1616	25,4	1.00	15,7	0.62	47,7	1.88	31,5	1.24	20,5	0.81

Braze and weld to SAE 37° flare

Weld port/SAE 37° flare

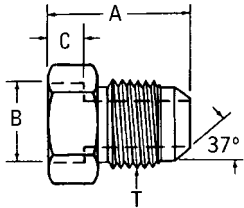

202232-(Dash size)

Dash size	IPS Size		Thread T	A		B		C	
	mm	in		mm	in	mm	in	mm	in
1/4-8S	6,3	0.25	3/4-16	30,5	1.20	14,2	0.56	9,7	0.38
1/2-12S	12,7	0.50	1 1/16-12	39,1	1.54	21,8	0.86	12,7	0.50
1-20S	25,4	1.00	1 5/8-12	46,0	1.81	34,0	1.34	16,0	0.63

Braze port/SAE 37° flare

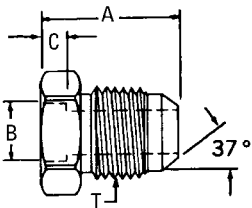

73014-(Dash size)

Dash size	Tube O.D.		Thread T	A		B		C	
	mm	in		mm	in	mm	in	mm	in
4S	6,3	0.25	7/16-20	18,8	0.74	6,4	0.25	4,0	0.16
5S	7,9	0.31	1/2-20	20,3	0.80	7,9	0.31	4,0	0.16
6S	9,6	0.38	9/16-18	20,6	0.81	9,7	0.38	4,0	0.16
8S	12,7	0.50	3/4-16	23,9	0.94	12,7	0.50	4,0	0.16
8-6S	12,7	0.50	9/16-18	21,3	0.84	12,7	0.50	4,0	0.16
10S	15,7	0.62	7/8-14	27,2	1.07	15,7	0.62	4,0	0.16
12S	19,0	0.75	1 1/16-12	31,5	1.24	19,0	0.75	6,4	0.25
12-10S	19,0	0.75	7/8-14	28,7	1.13	19,0	0.75	6,4	0.25
16S	25,4	1.00	1 5/16-12	32,8	1.29	25,4	1.00	6,4	0.25
16-12S	25,4	1.00	1 1/16-12	31,5	1.24	25,4	1.00	6,4	0.25
16-20S	31,7	1.25	1 5/8-12	35,6	1.40	25,4	1.00	6,4	0.25
20S	31,7	1.25	1 5/8-12	35,6	1.40	31,8	1.25	6,4	0.25
20-16S	31,7	1.25	1 5/16-12	32,8	1.29	31,8	1.25	6,4	0.25
24S	38,1	1.50	1 7/8-12	40,1	1.58	38,1	1.50	6,4	0.25
24-20S	38,1	1.50	1 5/8-12	37,1	1.46	38,1	1.50	6,4	0.25
24-32S	38,1	1.50	2 1/2-12	49,5	1.95	38,1	1.50	6,4	0.25
32S	50,8	2.00	2 1/2-12	49,8	1.96	50,8	2.00	6,4	0.25
40S	63,5	2.50	3-12	47,2	1.86	63,5	2.50	6,4	0.25

Steel adapters

Application data

J

Versil-Flare™ flareless and Versil-Flare SAE 37° flared type

Both styles use the same SAE 37° flared body

Before connection

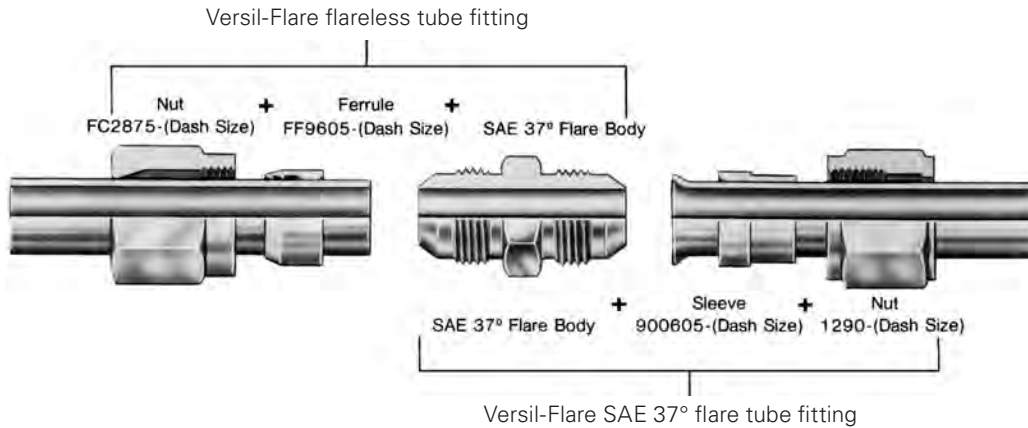

After connection

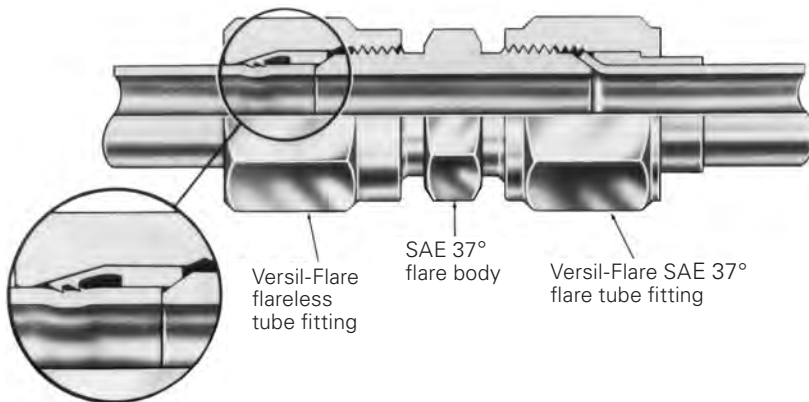

One inventory of bodies (any standard SAE 37° flare fitting) allows both flareless and flared type connection of standard steel hydraulic tubing. It is no longer necessary to inventory flared tube fittings plus the special bodies, nuts and sleeves for flareless tube fittings. The Eaton total tube fitting concept reduces inventory expense.

Versil-Flare™ flareless tube fitting

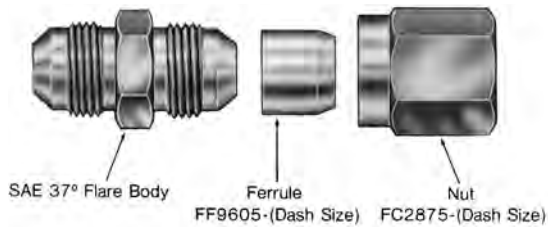

The Eaton Versil-Flare flareless tube fitting can use any standard SAE 37° male flare adapter or hose fitting as a body. This eliminates the need to inventory special flareless tube fitting bodies and results in reduced inventory expense. Eaton Versil-Flare flareless tube fittings are available in size from 3/16" tube O.D. to 2" tube O.D.

Presetting tools and extra assembly time are eliminated because there's no need for flaring, special preparation or presetting with the Eaton Versil-Flare flareless tube fitting. The chance of assembly error is reduced because the ferrule can be installed only one way and assembly is the same for all sizes and tube wall thicknesses. This assures a tight joint every time. These features improve production rates.

Selection and sizing for both Eaton Versil-Flare flareless and Versil-Flare flared tube fittings

Tube selection and sizing

Both Eaton Versil-Flare flareless and flared tube fittings can be used with SAE J-525 electric resistance welded, cold worked annealed, SAE J-524 seamless annealed tubing and SAE J527 brazed double wall low carbon steel tubing. SAE J356 welded flash controlled normalized steel tubing can only be used with Eaton Versil-Flare flareless tube fittings. **The maximum hardness of the above tubing should not exceed Rockwell B65.** Selection of proper tubing material, size and wall thickness depends on corrosion conditions, pressure and flow requirements and other operating requirements of the system.

Versil-Flare™ flared tube fitting

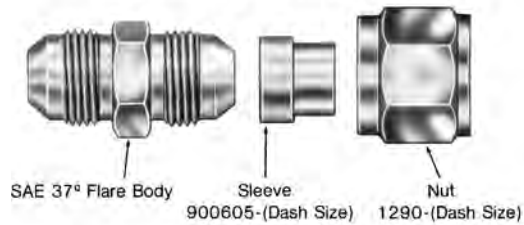

The Eaton industrial standard three piece Versil-Flare flared type tube fitting can be used on the full range of standard steel hydraulic tubing in various wall thicknesses from 3/16" tube O.D. to 2" tube O.D. All three components are constructed from high quality zinc plated steel for long service life.

The standard SAE 37° flare angle is used to produce a highly efficient seal under hydraulic pressures. The sleeve is used to help support the tube and absorb vibration.

Assembly is easy. A properly sized wrench and flaring tool are all that is necessary. This is important in tight locations. Eaton standard SAE 37° flare type fittings can also be dis-assembled and reassembled repeatedly.

Eaton quality is built into every component to assure leakproof connections. The Eaton standard SAE 37° flare type tube fitting conforms to the following hydraulic tube fitting standards. Society of Automotive Engineers, SAE J514.

Steel adapters

Versil-Flare™ - flareless and flared

J

Versil-Flare - flareless and flared

Versil-Flare flareless tube nut

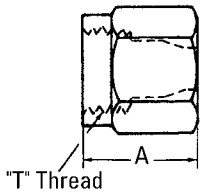

FC2875-(Dash size)

Use with FF9605-(Dash size) ferrule only

Dash size	Tube O.D.		Thread T	A	
	mm	in		mm	in
03S	4,8	0.19	3/8-24	20,1	0.79
04S	6,3	0.25	7/16-20	20,8	0.82
05S	7,9	0.31	1/2-20	20,8	0.82
06S	9,6	0.38	9/16-18	21,8	0.86
08S	12,7	0.50	3/4-16	27,4	1.08
10S	16,0	0.63	7/8-14	28,5	1.12
12S	19,0	0.75	1 1/16-12	34,5	1.36
16S	25,4	1.00	1 5/16-12	35,6	1.40
20S	31,7	1.25	1 5/8-12	45,7	1.80
24S	38,1	1.50	1 7/8-12	46,7	1.84

Versil-Flare flareless tube ferrule

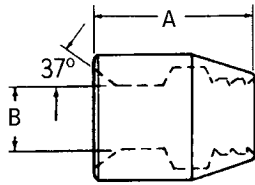

FF9605-(Dash size)

Use with FC2875-(Dash size) nut only

Dash size	Tube O.D.		A		B	
	mm	in	mm	in	mm	in
03S	4,8	0.19	10,2	0.40	4,8	0.19
04S	6,3	0.25	10,7	0.42	6,4	0.25
05S	7,9	0.31	10,7	0.42	7,9	0.31
06S	9,6	0.38	11,7	0.46	9,7	0.38
08S	12,7	0.50	14,5	0.57	12,7	0.50
10S	16,0	0.63	14,7	0.58	15,7	0.62
12S	19,0	0.75	17,8	0.70	19,0	0.75
16S	25,4	1.00	17,8	0.70	25,4	1.00
20S	31,7	1.25	25,4	1.00	31,8	1.25
24S	38,1	1.50	25,4	1.00	38,1	1.50
32S	50,8	2.00	29,7	1.17	50,8	2.00

Versil-Flare SAE 37° Nut

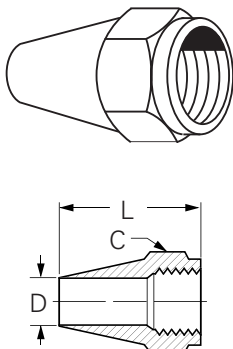

221000-(Dash size) (Ref. SAE 070111)

(Formerly Weatherhead series C5115x)

Dash size	Tube O.D.		Hex C		D		L
	mm	in	mm	in	mm	in	
4S	6,3	1/4	14,3	9/16	6,4	.255	25,4 1.00
5S	7,9	5/16	16,0	5/8	7,9	.318	26,9 1.06
6S	9,6	3/8	17,8	11/16	9,7	.380	27,6 1.09
8S	12,7	1/2	22,3	7/8	12,8	.505	32,5 1.28
10S	16,0	5/8	25,4	1	16,0	.631	37,6 1.48
12S	19,0	3/4	31,7	1-1/4	19,2	.756	42,2 1.66
14S	22,2	7/8	34,9	1-3/8	22,4	.881	46,0 1.81
16S	25,4	1	38,1	1-1/2	25,6	1.006	49,3 1.94

Versil-Flare - flareless and flared

Versil-Flare SAE 37° flared style "B" nut

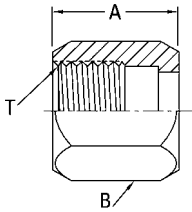

1290-(Dash size) (Ref. SAE 070110)
(Formerly Weatherhead series C5105x)
Use with 900605 tube sleeve only

Dash size	Tube O.D.		Thread T	A		B	
	mm	in		mm	in	mm	in
2S	3,3	0.13	5/16-24	14,0	0.55	9,5	0.38
3S	4,8	0.19	3/8-24	15,2	0.60	11,2	0.44
4S*	6,3	0.25	7/16-20	15,7	0.62	14,2	0.56
5S	7,9	0.31	1/2-20	17,0	0.67	15,7	0.62
6S*	9,6	0.38	9/16-18	18,3	0.72	17,6	0.69
8S*	12,7	0.50	3/4-16	21,3	0.84	22,4	0.88
10S*	16,0	0.63	7/8-14	24,6	0.97	25,4	1.00
12S*	19,0	0.75	1 1/16-12	25,9	1.02	31,8	1.25
14S	22,3	0.88	1 3/16-12	27,4	1.08	35,1	1.38
16S*	25,4	1.00	1 5/16-12	28,5	1.12	38,1	1.50
20S	31,7	1.25	1 5/8-12	31,0	1.22	50,8	2.00
24S*	38,1	1.50	1 7/8-12	35,8	1.41	57,2	2.25
32S	50,8	2.00	2 1/2-12	40,4	1.59	73,1	2.88

* Also available in stainless steel as 259-1290-(dash size).
(Formerly Weatherhead part number 5117x)

Versil-Flare SAE 37° flared sleeve

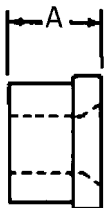
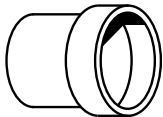

900605-(Dash size) (Ref. SAE 070115)
(Formerly Weatherhead series C5165x)
Use with 1290 short nut only

Dash size	Tube O.D.		A	
	mm	in	mm	in
2S	3,3	0.13	8,6	0.34
3S	4,8	0.19	8,6	0.34
4S	6,3	0.25	10,4	0.41
5S	7,9	0.31	11,2	0.44
6S	9,6	0.38	12,7	0.50
8S	12,7	0.50	14,2	0.56
10S	16,0	0.63	16,8	0.66
12S	19,0	0.75	17,6	0.69
14S	22,3	0.88	19,3	0.76
16S	25,4	1.00	19,8	0.78
20S	31,7	1.25	23,1	0.91
24S	38,1	1.50	28,5	1.12
32S	50,8	2.00	30,3	1.19

* Also available in stainless steel as 259-900605-(dash size).
(Formerly Weatherhead part number 5177x)

Steel adapters

Specials

J

Specials

External pipe/30° flare

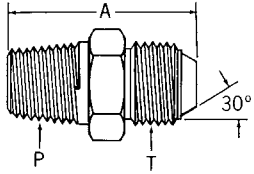

2004-(Dash size)

(Formerly Weatherhead series C92)

Dash size	Tube O.D.		Thread P	Thread T	A	
	mm	in			mm	in
12-16S	25,4	1.00	3/4-14	1 5/16-14	46,7	1.84
16-16S	25,4	1.00	1-11 1/2	1 5/16-14	51,6	2.03
20-20S	31,7	1.25	1 1/4-11 1/2	1 5/8-14	59,4	2.34

42° Inverted flare/SAE 37° flare

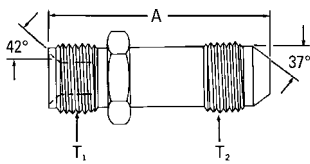

202124-(Dash size) and FF1327-(Dash size) Long*

(Formerly Weatherhead series C5880x)

Dash size	Tube O.D.		Thread T1	Thread T2	A	
	mm	in			mm	in
3-3S	4,8	0.19	3/8-24	3/8-24	27,2	1.07
3-4S	6,3	0.25	3/8-24	7/16-20	29,0	1.14
0304S*	6,3	0.25	3/8-24	7/16-20	61,0	2.40
4-4S	6,3	0.25	7/16-24	7/16-20	29,0	1.14
0404S*	6,3	0.25	7/16-24	7/16-20	61,0	2.40
5-4S	6,3	0.25	1/2-20	7/16-20	29,5	1.16
5-5S	7,9	0.31	1/2-20	1/2-20	29,0	1.14
5-6S	9,6	0.38	1/2-20	9/16-18	30,2	1.19
6-6S	9,6	0.38	5/8-18	9/16-18	31,0	1.22
8-8S	12,7	0.50	3/4-18	3/4-18	37,1	1.46

*Length required to insert adapter at installation.

42° Inverted flare/SAE 37° flare (Brass)

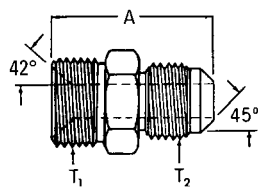

⚠ WARNING: California Proposition 65, see page A-2.

200001-(Dash size)

Dash size	Tube O.D.		Thread T1	Thread T2	A	
	mm	in			mm	in
4-4B	6,3	0.25	7/16-24	7/16-20	27,7	1.09
4-5B	7,9	0.31	7/16-24	1/2-20	28,5	1.12
4-6B	9,6	0.38	7/16-24	5/8-18	30,7	1.21
5-4B	6,3	0.25	1/2-20	7/16-20	27,9	1.10
5-5B	7,9	0.31	1/2-20	1/2-20	29,5	1.16
5-6B	9,6	0.38	1/2-20	5/8-18	31,8	1.25
6-5B	7,9	0.31	5/8-18	1/2-20	31,0	1.22
6-6B	9,6	0.38	5/8-18	5/8-18	32,5	1.28
7-6B	9,6	0.38	11/16-18	5/8-18	36,3	1.43
7-8B	12,7	0.50	11/16-18	3/4-16	39,6	1.56
8-6B	9,6	0.38	3/4-18	5/8-18	36,3	1.43
8-8B	12,7	0.50	3/4-18	3/4-16	39,6	1.56
10-10B	16,0	0.63	7/8-18	7/8-14	44,7	1.76
12-12B	19,0	0.75	1 1/16-16	1 1/16-14	52,0	2.05

Specials

30° Inverted flare/SAE 37° flare

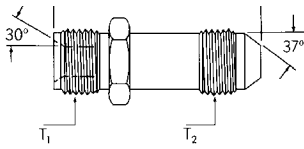

FF1353-(Dash size) and FF1354-(Dash size) long*

Dash size	Tube O.D.		Thread T1	Thread T2	A	
	mm	in			mm	in
0404S	6,3	0.25	7/16-20	7/16-20	33,8	1.33
0404S*	6,3	0.25	7/16-20	7/16-20	63,5	2.50

*Length required to insert adapter at installation.

Restrictor male pipe/female pipe

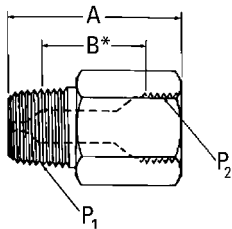

FF1980-(Dash size)†

Dash size	Tube O.D.		Thread P1	Thread P2	A		B*	
	mm	in			mm	in	mm	in
0404	6,3	0.25	1/4-18	1/4-18	35,3	1.39	16,2	0.64
0606	9,6	0.38	3/8-18	3/8-18	36,6	1.44	17,6	0.69
0808	12,7	0.50	1/2-14	1/2-14	47,5	1.87	22,1	0.87

*Length required to insert adapter at installation.

† Ordering Information: Eaton Restrictor Adapters are available in orifice sizes from 0.60 to 0.25 inches.

When ordering restrictor adapters, it is important to indicate the drill size required.

For example: For a 0.125 drill size in FF1980-0404 adapter, order as FF1980-125-0404.

If you indicate the desired orifice size in inches, the appropriate 3 digit number will be assigned.

Restrictor SAE 37° male flare/SAE 37° female

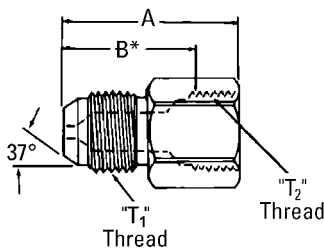

FF1981-(Dash size)†

Dash size	Tube O.D.		Thread T1	Thread T2	A		B*	
	mm	in			mm	in	mm	in
0404	6,3	0.25	7/16-20	7/16-20	28,9	1.14	17,5	0.69
0606	9,6	0.38	9/16-18	9/16-18	30,2	1.19	18,3	0.72
0808	12,7	0.50	3/4-16	3/4-16	34,5	1.36	25,6	1.01

*Length required to insert adapter at installation.

† Ordering Information: Eaton Restrictor Adapters are available in orifice sizes from 0.60 to 0.25 inches.

When ordering restrictor adapters, it is important to indicate the drill size required.

For example: For a 0.125 drill size in FF1980-0404 adapter, order as FF1980-125-0404.

If you indicate the desired orifice size in inches, the appropriate 3 digit number will be assigned.

SAE 37° flare to O-Ring port (steel)

Includes O-ring

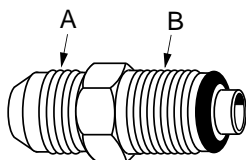

FF4184-(Dash size)

(Formerly Weatherhead series 41157x)

Dash size	Tube size	Thread A	Thread B
-0404S	1/4	7/16-20	7/16-24
-0606S	3/8	9/16-18	5/8-18
-0808S	1/2	3/4-16	3/4-16
-1010S	5/8	7/8-14	7/8-14
-1212S	3/4	1 1/16-12	1 1/16-16

Includes O-Ring.

Steel adapters

Metric thread dimensions

J

Metric thread dimensions

Conversion adapters

Sealing is achieved by means of an O-Ring, retaining washer and a properly machined port. The O-Ring is "captured" by the I.D. of the retaining washer. The port may be of the spot faced or a flat machined surface as long as the D6 dimension is met. For assembly instructions for adjustable type adapters page J-26.

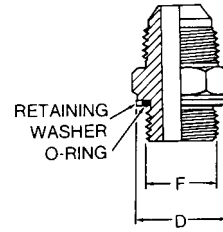
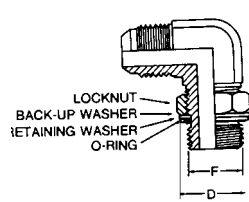

DIN 3852 large spot face

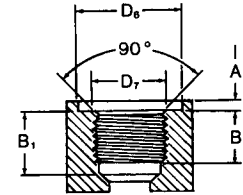

Equivalent to DIN 3852 form x

Thread size	M 10 x 1	M 12 x 1.5	M 14 x 1.5	M 16 x 1.5	M 18 x 1.5	M 20 x 1.5	M 22 x 1.5	M 26 x 1.5	M 27 x 2	M 33 x 2	M 42 x 2	M 48 x 2
F Thread Dia.	10.0	12.0	14.0	16.0	18.0	20.0	22.0	26.0	27.0	33.0	42.0	48.0
A max	1.0	1.5	1.5	1.5	2.0	2.0	2.5	2.5	2.5	2.5	2.5	2.5
B min (full thread)	12.0	12.0	12.0	12.0	12.0	14.0	14.0	16.0	16.0	18.0	20.0	22.0
B1 min	13.5	18.5	18.5	18.5	18.5	20.5	20.5	22.5	24.0	26.0	28.0	30.0
D max	15.7	18.7	19.7	23.2	26.2	28.2	30.2	35.2	36.2	43.2	52.7	58.7
D6 min	16.2	19.2	20.2	23.7	26.9	28.9	30.7	35.7	36.7	44.4	53.4	59.9
D7 max	10.2	12.2	14.2	16.2	18.2	20.2	22.2	26.2	27.2	33.3	42.3	48.3

BSPP (parallel) threads

Sealing is achieved by means of an O-Ring, retaining washer and a properly machined port.

The O-Ring is "captured" by the I.D. of the retaining washer. The compression is controlled by the thickness of the retaining washer.

The port may be of the spot faced or a flat machined surface as long as the D6 dimension is met.

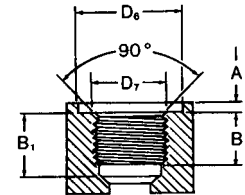
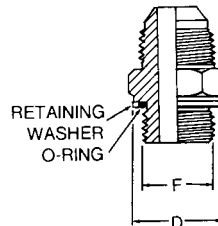
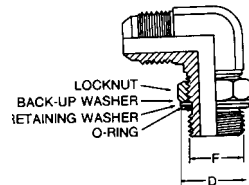

Thread size	G 1/8"-28		G 1/4"-19		G 3/8"-19		G 1/2"-14		G 3/4"-14		G 1"-11		G 1 1/4"-11		G 1 1/2"-11	
	mm	in	mm	in	mm	in	mm	in	mm	in	mm	in	mm	in	mm	in
F Thread Dia.	9,7	0.38	13,2	0.50	16,7	0.66	20,9	0.83	26,4	1.04	33,3	1.31	41,9	1.65	47,8	1.88
A max	1,0	0.04	2,0	0.08	2,05	0.10	2,5	0.10	2,5	0.10	2,5	0.10	2,5	0.10	2,5	0.10
B1 min (full thread)	8,0	0.31	12,0	0.47	12,0	0.47	14,0	0.63	16,0	0.63	18,0	0.71	20,0	0.79	22,0	0.87
B1 min	13,0	0.51	18,5	0.73	18,5	0.73	22,0	0.94	24,0	0.94	27,0	1.06	29,0	1.14	31,0	1.22
D max	15,7	0.62	19,7	0.78	24,0	0.94	28,7	1.38	35,2	1.38	43,2	1.70	52,7	2.07	58,7	2.31
D6 min	16,2	0.64	20,2	0.81	24,9	0.98	29,4	1.43	36,4	1.43	44,4	1.75	53,4	2.10	59,9	2.36
D7 max	10,0	0.39	13,4	0.53	16,9	0.67	21,2	1.05	26,7	1.05	33,6	1.32	42,3	1.67	48,2	1.90

BSPT (tapered) threads port sealing

Sealing is achieved by means of metal to metal deformation of the adapter and port threads.

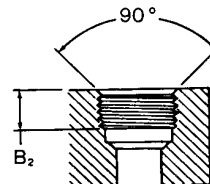

Thread size 11	R 1/8"-28		R 1/4"-19		R 3/8"-19		R 1/2"-14		R 3/4"-14		R 1"-11		R 1 1/4"-11		R 1 1/2"-11	
	mm	in	mm	in	mm	in	mm	in	mm	in	mm	in	mm	in	mm	in
B2 min (full thread)	5,5	0.22	8,5	0.33	8,5	0.33	10,5	0.41	13,0	0.51	14,5	0.57	17,0	0.67	17,0	0.67

Metric to SAE 37° flare

Metric 24° (DIN 3901/3902 I.Rh)/SAE 37° flare

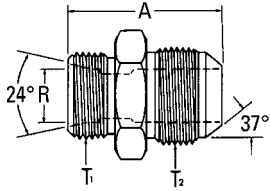

15.063-(Dash size)

(Formerly Weatherhead series MC5206x)

Dash size	Tube O.D.		Thread T1	Thread T2	A		Rø	
	mm	in			mm	in	mm	in
6-4	6,4	0.25	M12 x 1.5	7/16-20	31,0	1.22	6,0	0.24
8-6	9,7	0.38	M14 x 1.5	9/16-18	31,0	1.22	8,0	0.31
10-8	12,7	0.50	M16 x 1.5	3/4-16	34,5	1.36	10,0	0.39
12-8	12,7	0.50	M18 x 1.5	3/4-16	34,5	1.36	12,0	0.47
15-10	16,0	0.63	M22 x 1.5	7/8-14	39,1	1.54	15,0	0.59
18-12	19,0	0.75	M26 x 1.5	1 1/16-12	42,9	1.69	18,0	0.71
22-16	25,4	1.00	M30 x 2.0	1 5/16-12	46,0	1.81	22,0	0.87

Metric 24° (DIN 3902 s.Rh)/SAE 37° flare

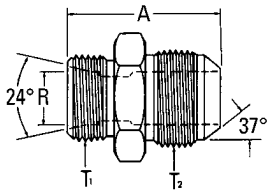

15.147-(Dash size)

(Formerly Weatherhead series MC5208x)

Dash size	Tube O.D.		Thread T1	Thread T2	A		Rø	
	mm	in			mm	in	mm	in
6-6	9,7	0.38	M14 x 1.5	9/16-18	33,0	1.30	6,0	0.24
10-8	12,7	0.50	M18 x 1.5	3/4-16	35,6	1.40	10,0	0.39
14-10	16,0	0.63	M22 x 1.5	7/8-14	40,4	1.59	14,0	0.55
16-12	19,0	0.75	M24 x 1.5	1 1/16-12	44,9	1.77	16,0	0.63
20-16	25,4	1.00	M30 x 2.0	1 5/16-12	48,0	1.89	20,0	0.79

Metric 60° (DIN 7631)/SAE 37° flare

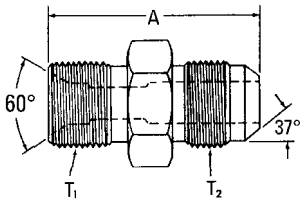

15.117-(Dash size)

(Formerly Weatherhead series MC5207x)

Dash size	Tube O.D.		Thread T1	Thread T2	A	
	mm	in			mm	in
4-4	6,3	0.25	M12X1.5	7/16-20	31,0	1.22
6-6	9,7	0.38	M14 x 1.5	9/16-18	31,0	1.22
8-6	9,7	0.38	M16 x 1.5	9/16-18	32,0	1.26
8-8	12,7	0.50	M16 x 1.5	3/4-16	34,5	1.36
10-8	12,7	0.50	M18 x 1.5	3/4-16	34,5	1.36
16-12	19,0	0.75	M26 x 1.5	1 1/16-12	42,9	1.69
20-16	50,8	2.00	M30X1,5	1 5/16-12	46,0	1.81
25-20	31,8	1.25	M38 x 1.5	1 5/8-12	47,5	1.87

Steel adapters

Metric to SAE 37° flare

J

Metric to SAE 37° flare

Metric 24° (DIN 3902 s.Rh)/SAE 37° flare

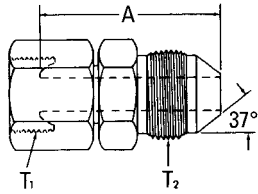

15.164-(Dash size)

Dash size	Tube O.D.		Thread T1	Thread T2	A	
	mm	in			mm	in
6-6	9,7	0.38	M14 x 1.5	9/16-18	35,1	1.38
10-8	12,7	0.50	M18 x 1.5	3/4-16	38,1	1.50
14-10	16,0	0.63	M22 x 1.5	7/8-14	40,9	1.61
16-12	19,0	0.75	M24 x 1.5	1 1/16-12	43,4	1.71
20-16	25,4	1.00	M30 x 2.0	1 5/16-12	47,0	1.85
30-24	38,1	1.50	M42 x 2.0	1 7/8-12	53,9	2.12

SAE 37° flare to metric O-Ring port adapter (steel)

Includes O-ring

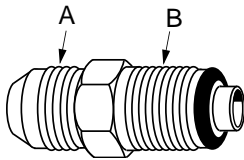

FF4215-(Dash size)

(Formerly Weatherhead series M41157x)

Dash size	Tube size	Thread A	Thread B
-0614S	3/8	9/16-18	M14X1.5
-0616S	3/8	9/16-18	M16X1.5
-0618S	3/8	9/16-18	M18X1.5

Includes O-Ring.

Metric 24° (DIN 3901/3902 I.Rh)/SAE 37° flare

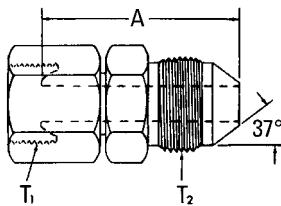

15.163-(Dash size)

Dash size	Tube O.D.		Thread T1	Thread T2	A	
	mm	in			mm	in
4-4 †	6,4	0.25	M12 x 1.5	7/16-20	34,5	1.36
6-6 †	9,7	0.38	M14 x 1.5	9/16-18	34,5	1.36
8-6 †	9,7	0.38	M16 x 1.5	9/16-18	35,6	1.40
8-8 †	12,7	0.50	M16 x 1.5	3/4-16	38,1	1.50
10-8 †	12,7	0.50	M18 x 1.5	3/4-16	38,1	1.50
13-10 †	16,0	0.63	M22 x 1.5	7/8-14	40,9	1.61
16-12 †	19,0	0.75	M26 x 1.5	1 1/16-12	47,5	1.87

†Universal fitting also mates with 60° DIN 7631/7647 connections.

For additional Metric 24° adapters please refer to Eaton's Walterscheid metric tube fittings catalog E-MEFI-MC002-E1 (or E-MEFI-MC001-M2 for the global version).

Metric to SAE 37° flare

Metric 60° (DIN 7631)/SAE 37° flare

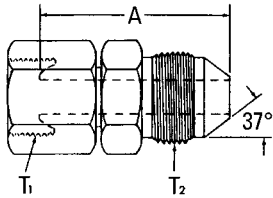

15.165-(Dash size)

Dash size	Tube O.D.		Thread T1	Thread T2	A	
	mm	in			mm	in
20-16	25,4	1.00	M30 x 1.5	1 5/16-12	46,0	1.81
25-20	31,7	1.25	M38 x 1.5	1 5/8-12	49,5	1.95
32-24	38,1	1.50	M45 x 1.5	1 7/8-12	52,6	2.07

SAE 37° male/DIN 3852 metric male

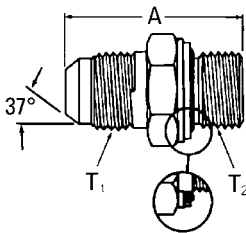

GG108-NP(Size)-(Dash size)

(Formerly Weatherhead series MC5315x)

Dash size	Tube O.D.		Thread T1	Thread T2	A	
	mm	in			mm	in
04-10	6,4	0.25	7/16-20	M10 x 1.0	29,0	1.14
04-12	6,4	0.25	7/16-20	M12 x 1.5	33,0	1.30
04-14	6,4	0.25	7/16-20	M14 x 1.5	34,0	1.34
05-10	7,9	0.31	1/2-20	M10 x 1.0	29,0	1.14
06-14	9,7	0.38	9/16-18	M14 x 1.5	34,0	1.34
06-16	9,7	0.38	9/16-18	M16 x 1.5	34,0	1.34
08-16	12,7	0.50	3/4-16	M16 x 1.5	37,1	1.46
08-18	12,7	0.50	3/4-16	M18 x 1.5	37,6	1.48
08-22	12,7	0.50	3/4-16	M22 x 1.5	40,1	1.58
10-18	16,0	0.63	7/8-14	M18 x 1.5	40,1	1.58
10-20	16,0	0.63	7/8-14	M20 x 1.5	42,9	1.69
10-22	16,0	0.63	7/8-14	M22 x 1.5	42,9	1.69
12-22	19,0	0.75	1 1/16-12	M22 x 1.5	46,5	1.83
12-27	19,0	0.75	1 1/16-12	M27 x 2.0	49,5	1.95
16-33	25,4	1.00	1 5/16-12	M33 x 2.0	53,6	2.11
20-42	31,8	1.25	1 5/8-12	M42 x 2.0	58,5	2.30

SAE 37° male 90° adjustable elbow/ DIN 3852 metric male

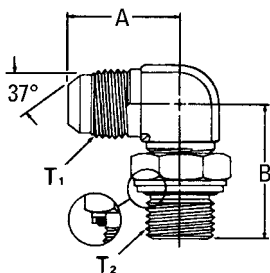

GG308-NP(Size)-(Dash size)

(Formerly Weatherhead series MC5515x)

Dash size	Tube O.D.		Thread T1	Thread T2	A		Rø	
	mm	in			mm	in	mm	in
04-10	6,4	0.25	7/16-20	M10 x 1	22,6	0.89	25,9	1.02
04-12	6,4	0.25	7/16-20	M12 x 1.5	26,9	1.06	31,5	1.24
06-14	9,7	9,7	9/16-18	M14 x 1.5	27,0	1.06	31,5	1.24
06-16	9,7	0.38	9/16-18	M16 x 1.5	28,5	1.12	36,6	1.44
08-18	12,7	0.50	3/4-16	M18 x 1.5	31,5	1.24	36,6	1.44
10-18	16,0	0.63	7/8-14	M18 x 1.5	36,6	1.44	39,6	1.56
10-20	16,0	0.63	7/8-14	M20 x 1.5	36,6	1.44	42,9	1.69
10-22	16,0	0.63	7/8-14	M22 x 1.5	36,6	1.44	42,9	1.69
12-22	19,0	0.75	1 1/16-12	M22 x 1.5	41,9	1.65	45,5	1.79
12-27	19,0	0.75	1 1/16-12	M27 x 2.0	41,9	1.65	49,0	1.93

Steel adapters

ORS to metric

J

ORS to metric

ORS – Special metric connector

(mates with DIN 3852 large spotface)

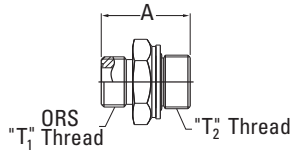

FF2485T(Dash size)

Dash size	Tube O.D.		Thread T1	Thread T2	Ref A	
	mm	in			mm	in
0818S	12,7	0.50	13/16-16	M18 x 1.5	33,6	1.32
0822S	12,7	0.50	13/16-16	M22 x 1.5	36,3	1.43

ORS/male ISO 6149 O-Ring seal

(S-series)

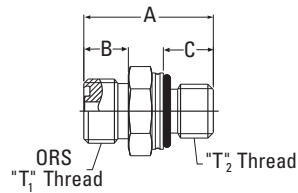

FF2742T(Dash size) (Ref. SAE 52M0187)

Dash size	Tube O.D.		Thread T1	Thread T2	A		B		C	
	mm	in			mm	in	mm	in	mm	in
0612S	9,7	0.38	11/16-16	M12 x 1.5	32,0	1.26	11,2	0.44	10,9	0.43
0614S	9,7	0.38	11/16-16	M14 x 1.5	32,0	1.26	11,2	0.44	10,9	0.43
0818S	12,7	0.50	13/16-16	M18 x 1.5	38,1	1.50	12,7	0.50	14,0	0.55
0822S	12,7	0.50	13/16-16	M22 x 1.5	39,4	1.55	12,7	0.50	15,0	0.59
1022S	16,0	0.63	1-14	M22 x 1.5	41,9	1.65	15,5	0.61	15,0	0.59
1222S	19,0	0.75	1 3/16-12	M22 x 1.5	43,4	1.71	17,0	0.67	15,0	0.59

90° ORS/ISO 6149 O-Ring seal

(S-series)

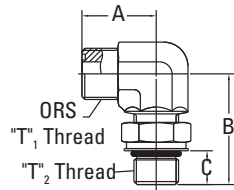

FF2744T(Dash size) (Ref. SAE 52M0287)

Dash size	Tube O.D.		Thread T1	Thread T2	A		B		C	
	mm	in			mm	in	mm	in	mm	in
0818S	12,7	0.50	13/16-16	M18 x 1.5	29,7	1.17	44,2	1.74	14,2	0.56

Metric sleeve

Sleeve 3-piece metric

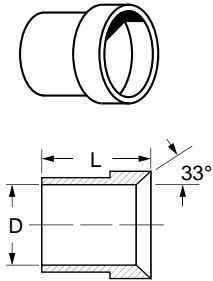

FF91488-(Dash size) (Ref. SAE 070115)
(Formerly Weatherhead series C5165x__M)

Dash size	Tube O.D.	D		L	
	in	mm	in	mm	in
-0406S	1/4	6,1	.241	10,4	.41
-0508S	5/16	8,1	.320	11,2	.44
-0610S	3/8	10,1	.399	12,7	.50
-0812S	1/2	12,1	.478	14,2	.56
-1014S	5/8	14,1	.556	16,8	.66
-1015S	5/8	15,1	.596	16,8	.66
-1016S	5/8	16,2	.636	16,8	.66
-1218S	3/4	18,2	.717	17,3	.68
-1420S	7/8	20,1	.793	19,3	.76
-2030S	1-1/4	30,2	1.191	23,1	.91
-2032S	1-1/4	32,3	1.270	23,1	.91

Adapts Standard SAE Flare-Twin® Hose Ends for use with metric tubing.

Pipe to metric

Female SAE 37° swivel to male metric taper pipe thread

(Pipe thread per DIN 3852)

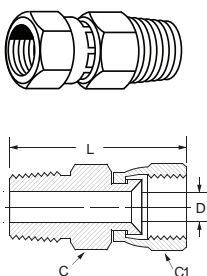

FF4180-(Dash size)
(Formerly Weatherhead series M9700x)

Dash size	Tube O.D	Taper pipe thread metric	Hex C		Hex C1		D		L	
			mm	in	mm	in	mm	in	mm	in
-0406S	1/4	M10x1.0	14,2	9/16	14,2	9/16	4,4	.172	31,8	1.25
-0508S	5/16	M12x1.5	17,5	11/16	15,9	5/8	5,9	.234	39,1	1.54
-0610S	3/8	M14x1.5	17,5	11/16	17,5	11/16	7,5	.297	40,6	1.60
-0812S	1/2	M16x1.5	22,2	7/8	22,2	7/8	9,9	.391	45,2	1.78
-1014S	5/8	M20x1.5	25,4	1	25,4	1	12,3	.484	48,5	1.91
-1220S	3/4	M24x1.5	28,6	1-1/8	28,6	1-1/8	15,4	.609	51,8	2.04
-1625S	1	M27x2.0	34,9	1-3/8	38,1	1-1/2	21,5	.845	58,4	2.30
-2032S	1-1/4	M36x2.0	47,6	1-7/8	50,8	2	27,4	1.079	61,7	2.43

Steel adapters

BSPP to SAE 37° flare

J

BSPP to SAE 37° flare

BSPP (parallel)/SAE 37° flare

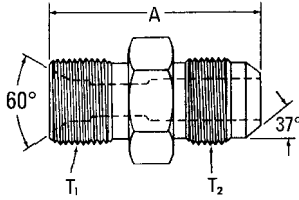

2063-(Dash size)

Dash size	Tube O.D.		Thread T1	Thread T2	A	
	mm	in			mm	in
2-4S	6,4	0.25	G 1/8-28	7/16-20	35,1	1.38
4-4S	6,4	0.25	G 1/4-19	7/16-20	35,1	1.38
4-5S	7,9	0.31	G 1/4-19	1/2-20	35,1	1.38
4-6S	9,7	0.38	G 1/4-19	9/16-18	35,1	1.38
6-6S	9,7	0.38	G 3/8-19	9/16-18	36,3	1.43
6-8S	12,7	0.50	G 3/8-19	3/4-16	38,9	1.53
8-8S	12,7	0.50	G 1/2-14	3/4-16	41,4	1.63
8-10S	16,0	0.63	G 1/2-14	7/8-14	43,9	1.73
10-12S	19,0	0.75	G 5/8-14	1 1/16-12	49,3	1.94
12-10S	16,0	0.63	G 3/4-14	7/8-14	47,7	1.88
12-12S	19,0	0.75	G 3/4-14	1 1/16-12	50,5	1.99
16-16S	25,4	1.00	G 1-11	1 5/16-12	53,1	2.09

Note: The BSPP male end mates with a BSPP female swivel nut. Use GG106 conversion adapters for port connections.

SAE 37° male/BSPP male

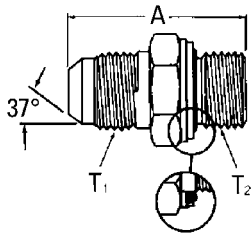

GG106-NP(Size)-(Dash size)

(Formerly Weatherhead series MB5315x)

Dash size	Tube O.D.		Thread T1	Thread T2	A	
	mm	in			mm	in
04-02	6,4	0.25	7/16-20	G1/8-28	29,0	1.14
04-04	6,4	0.25	7/16-20	G1/4-19	34,5	1.36
04-06	6,4	0.25	7/16-20	G3/8-19	34,5	1.36
04-08	6,4	0.25	7/16-20	G1/2-14	38,1	1.50
05-04	6,3	0.25	1/2-20	G1/4-19	34,5	1.36
06-04	9,7	0.38	9/16-18	G1/4-19	34,5	1.36
06-06	9,7	0.38	9/16-18	G3/8-19	34,5	1.36
06-08	9,7	0.38	9/16-18	G1/2-14	38,1	1.50
08-04	12,7	0.50	3/4-16	G1/4-19	37,6	1.48
08-06	12,7	0.50	3/4-16	G3/8-19	37,6	1.48
08-08	12,7	0.50	3/4-16	G1/2-14	40,9	1.61
08-12	12,7	0.50	3/4-16	G3/4-14	44,9	1.77
10-06	16,0	0.63	7/8-14	G3/8-19	40,4	1.59
10-08	16,0	0.63	7/8-14	G1/2-14	43,4	1.71
10-12	19,0	0.75	7/8-14	G 3/4-14	47,5	1.87
12-08	19,0	0.75	1 1/16-12	G1/2-14	47,0	1.85
12-12	19,0	0.75	1 1/16-12	G3/4-14	50,0	1.97
12-16	19,0	0.75	1 1/16-12	G1-11	52,6	2.07
16-12	25,4	1.00	1 1/16-12	G3/4-14	51,1	2.01
16-16	25,4	1.00	1 5/16-12	G1-11	53,6	2.11
16-20	25,4	1.00	1 5/16-12	G1 1/4-11	56,9	2.24
20-20	31,8	1.25	1 5/8-12	G1 1/4-11	58,4	2.30

BSPP to SAE 37° flare

90° adjustable elbow SAE 37° male/BSPP male adjustable

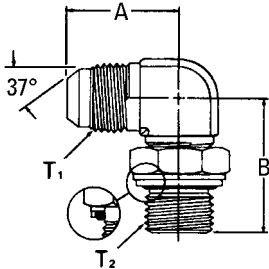

GG306-NP(Size)-(Dash size)

Dash size	Tube O.D.		Thread T1	Thread T2	A		B	
	mm	in			mm	in	mm	in
04-04	6,4	0.25	7/16-20	G1/4-19	26,9	1.06	31,5	1.24
05-04	7,9	0.31	1/2-20	G1/4-19	26,9	1.06	31,5	1.24
06-04	9,7	0.38	9/16-18	G1/4-19	26,9	1.06	31,5	1.24
06-06	9,7	0.38	9/16-18	G3/8-19	28,5	1.12	36,6	1.44
08-06	12,7	0.50	3/4-16	G3/8-19	31,5	1.24	36,6	1.44
08-08	12,7	0.50	3/4-16	G1/2-14	34,0	1.34	42,9	1.69
12-12	19,0	0.75	1 1/16-12	G3/4-14	41,9	1.65	49,0	1.93
16-16	25,4	1.00	1 5/16-12	G1-11	46,0	1.81	52,6	2.07
20-20	31,8	1.25	1 5/8-12	G1 1/4-11	52,0	2.05	56,9	2.24

SAE 37° female swivel/ BSPP male

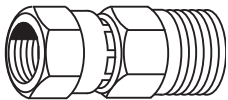

FF4179-(Dash size)

(Formerly Weatherhead series M9600x)

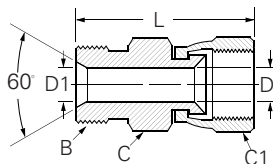

Dash size	Tube O.D.		BSPP pipe	Hex size		Hex C1		D		D1		L	
	mm	in		mm	mm	in	mm	in	mm	in	mm	in	mm
-0404S	6,4	1/4	G 1/4-19	14,3	9/16	14,3	9/16	4,4	.172	5,0	.198*	36,3	1.43
-0604S	9,7	3/8	G 1/4-19	17,5	11/16	17,5	11/16	7,5	.297	5,0	.198	39,6	1.56
-0606S	9,7	3/8	G 3/8-19	17,5	11/16	17,5	11/16	7,5	.297	8,4	.322*	42,2	1.66
-0806S	12,7	1/2	G 3/8-19	22,2	7/8	22,2	7/8	9,9	.391	8,4	.322	45,0	1.77
-0808S	12,7	1/2	G 1/2-14	22,2	7/8	22,2	7/8	9,9	.391	11,4	.448*	48,8	1.92
-1008S	15,9	5/8	G 1/2-14	25,4	1	25,4	1	12,3	.484	11,4	.448	50,0	1.97
-1212S	19,0	3/4	G 3/4-14	31,7	1-1/4	28,6	1-1/8	15,4	.609	16,9	.666*	55,9	2.25
-1616S	25,4	1	G 1-11	38,1	1-1/2	34,9	1-3/8	21,5	.845	22,5	.885*	62,9	2.48
-2020S	31,8	1-1/4	G 1-1/4-11	50,8	2	47,6	1-7/8	27,4	1.078	28,6	1.125*	67,1	2.64

*Optional counterbore.

BSPT to SAE 37° flare

SAE 37° male/BSPT male

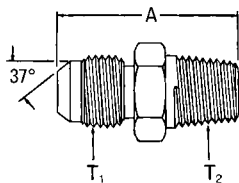

GG110-NP(Size)-(Dash size)

(Formerly Weatherhead series MC5205x)

Dash size	Tube O.D.		Thread T1	Thread T2	A	
	mm	in			mm	in
04-02	6,4	0.25	7/16-20	R1/8-28	29,0	1.14
04-04	6,4	0.25	7/16-20	R1/4-19	33,0	1.30
06-04	9,7	0.38	9/16-18	R1/4-19	33,6	1.32
06-06	9,7	0.38	9/16-18	R3/8-19	33,6	1.32
08-06	12,7	0.50	3/4-16	R3/8-19	36,6	1.44
08-08	12,7	0.50	3/4-16	R1/2-14	40,4	1.59
10-08	16,0	0.63	7/8-14	R1/2-14	42,9	1.69
12-08	19,0	0.75	1 1/16-12	R1/2-14	47,5	1.87
12-12	19,0	0.75	1 1/16-12	R3/4-14	49,5	1.95
16-16	25,4	1.00	1 5/16-12	R1-11	52,6	2.07

Steel adapters

BSPT to SAE 37° flare
JIS 30° to SAE 37° flare

J

BSPT to SAE 37° flare

90° elbow, SAE 37° male/BSPT male

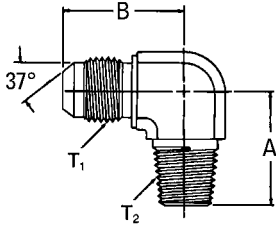

GG310-NP(Size)-(Dash size)
(Formerly Weatherhead series MC5405x)

Dash size	Tube O.D.		Thread T1	Thread T2	A		B	
	mm	in			mm	in	mm	in
04-04	6,4	0.25	7/16-20	R1/4-19	27,4	1.08	27,0	1.06
05-04	7,9	0.31	1/2-20	R1/4-19	27,4	1.08	27,0	1.06
06-04	9,7	0.38	9/16-18	R1/4-19	27,5	1.08	27,0	1.06
06-06	9,7	0.38	9/16-18	R3/8-19	31,0	1.22	28,5	1.12
06-08	9,7	0.38	9/16-18	R1/2-14	37,1	1.46	31,0	1.22
08-06	12,7	0.50	3/4-16	R3/8-19	31,0	1.22	31,5	1.24
08-08	12,7	0.50	3/4-16	R1/2-14	37,1	1.46	34,0	1.34
10-12	19,0	0.75	7/8-14	R3/4-14	40,5	1.59	39,5	1.55
12-12	19,0	0.75	1 1/16-12	R3/4-14	40,4	1.59	41,9	1.65
16-16	25,4	1.00	1 5/16-12	R1-11	50,0	1.97	46,0	1.81
20-20	31,7	1.25	1 5/8-12	R1 1/4-11	60,0	2.36	52,0	2.05

SAE 37° Female swivel to BSPT male pipe thread

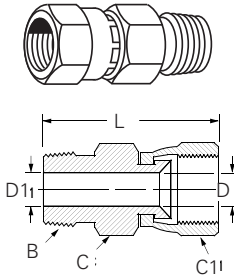

FF4181-(Dash size)
(Formerly Weatherhead series M9800x)

Dash size	Tube O.D.		BSPT pipe	Hex size		Hex C1		D		D1		L	
	mm	in		mm	in	mm	in	mm	in	mm	in	mm	in
-0404S	6,4	1/4	G 1/4-19	14,3	9/16	14,3	9/16	4,4	.172	7,1	.281*	39,6	1.56
-0504S	7,9	5/16	G 1/4-19	17,5	11/16	15,9	5/8	5,9	.234	7,1	.281*	41,4	1.63
-0604S	9,7	3/8	G 1/4-19	17,5	11/16	17,5	11/16	7,5	.297	7,1	.281	42,9	1.69
-0804S	12,7	1/2	G 1/4-19	22,2	7/8	22,2	7/8	9,9	.391	7,1	.281	47,5	1.87
-0806S	12,7	1/2	G 3/8-19	22,2	7/8	22,2	7/8	9,9	.391	10,3	.406*	47,5	1.87
-0808S	12,7	1/2	G 1/2-14	22,2	7/8	22,2	7/8	9,9	.391	13,5	.531*	52,3	2.06
-1008S	16,0	5/8	G 1/2-14	25,4	1	25,4	1	12,3	.484	13,5	.531*	53,6	2.11
-1208S	19,0	3/4	G 1/2-14	28,6	1 1/8	31,7	1 1/4	15,5	.609	13,5	.531	56,1	2.21
-1212S	19,0	3/4	G 3/4-14	28,6	1 1/8	31,7	1 1/4	15,5	.609	18,3	.719*	56,9	2.24
-1612S	25,4	1	G 3/4-14	34,9	1 3/8	38,1	1 1/2	21,5	.845	18,3	.719	60,7	2.39
-1616S	25,4	1	G 1-11	34,9	1 3/8	38,1	1 1/2	21,5	.845	23,8	.938*	64,8	2.55
-2020S	38,1	1-1/4	G 1 1/4-11	47,6	1 7/8	50,8	2	27,4	1.079	28,6	1.125*	69,3	2.73

*Optional counterbore.

JIS 30° to SAE 37° flare

JIS 30° Female cone seat/SAE 37° Male

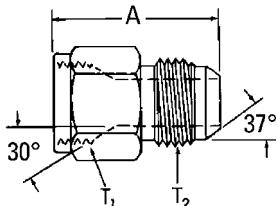

FF2593-(Dash size)

Dash size	Tube O.D.		Thread T1	Thread T2	A	
	mm	in			mm	in
0404S	6,4	0.25	G1/4-19	7/16-20	30,3	1.19
0606S	9,7	0.38	G3/8-19	9/16-18	30,7	1.21
0808S	12,7	0.50	G1/2-14	3/4-16	35,8	1.41
1212S	19,0	0.75	G3/4-14	1 1/16-12	43,2	1.70

7000 series Ermeto

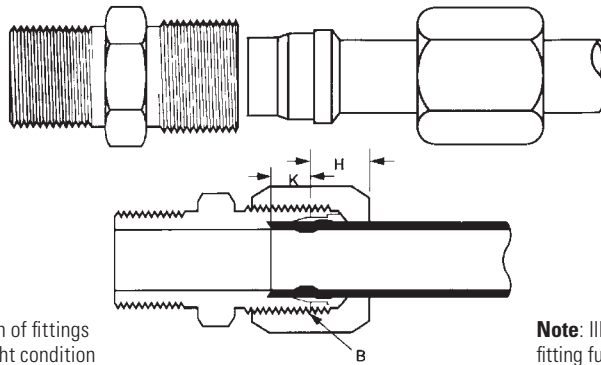

Note: "H" is dimension of fittings assembled to hand tight condition

Note: Illustration shows fitting fully assembled.

Tube O.D.	1/8	3/16	1/4	5/16	3/8	1/2	5/8	3/4	7/8	1	1 1/4	1 1/2	2
Thread size-B	5/16-24	3/8-24	7/16-20	1/2-20	9/16-18	3/4-16	7/8-14	1 1/16-12	1 3/16-12	1 5/16-12	1 5/8-12	1 7/8-12	2 1/2-12
Seat depth-K	0.19	0.24	0.24	0.26	0.26	0.31	0.36	0.36	0.36	0.42	0.42	0.49	0.49
H (Ref.)	0.31	0.30	0.39	0.41	0.47	0.48	0.53	0.55	0.53	0.63	0.56	0.61	0.64

Typical application

Hydraulic, instrumentation and chemical processing systems. Highly recommended for high pressure applications

Pressure

Operating pressure up to 10,000 psi depending on tube and fitting size.

Vibration

Excellent resistance

Temperature range

-65°F to +400°F (-53°C to +204°C) at maximum operating pressures. Has been used at 800°F and 1000 psi to 4000 psi depending on tube size.

Material

Carbon steel plating - Zinc Trivalent

Advantages

An excellent high pressure fitting - NO TUBE FLARING. Used with extra heavy wall tubing. Broad selection of sizes and styles.

Conformance

Meets specifications and standards of ASME and SAE.

How to order

For complete assembly (body, nut sleeve) order individually by part number. Example: 7205x4.

To order body only (less nut and sleeve), prefix the part number with the letter 'B'. Example: B7205X4.

Nuts and sleeves can be ordered separately by part number.

Steel adapters

7000 series Ermeto fittings

J

7000 series Ermeto fittings

Ermeto fittings (7000 Series) are especially designed for making leak-proof tube connections. This fitting will effectively withstand high pressure, severe vibration and extreme temperature. No special tools are needed for assembly. Simply cut tube square, preset sleeve on tubing and assemble.

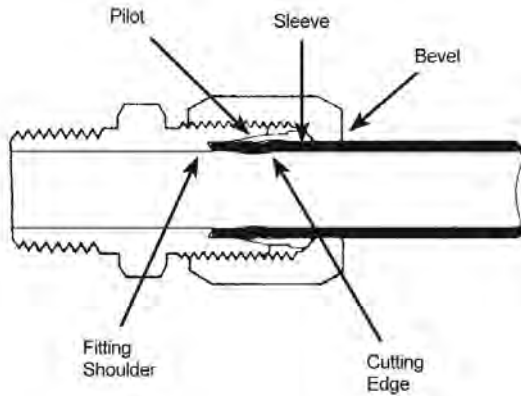

7000 series fittings

Specifically designed to meet all SAE approved standards for hydraulic flareless tube fittings. Available in a complete range of standard body styles.

Carbon steel 7000 series

Eaton Ermeto fittings have a zinc trivalent finish, which fully resists the effects of nonflammable hydraulic fluids.

Ermeto design principle provides positive seal

1. In presetting, as the nut is tightened it forces the sleeve forward into the body taper. See page J-145 for preset instructions.
2. Pilot of sleeve contracts, forcing the cutting edge of sleeve to shear a groove into outer surface of the tube, making a tight joint between fitting and tube.
3. In assembling the preset sleeve and tube into the fitting body, the nut presses on the bevel at rear of sleeve causing it to clamp tightly to the tube. Resistance to vibration is concentrated at this point rather than at the sleeve cut.
4. When fully tightened, the case hardened sleeve is bowed slightly at the midsection and acts as a spring. This spring action of the sleeve maintains a constant tension between the body and the nut, and thus prevents the nut from loosening.
5. After the first assembly, the sleeve is permanently attached to the tube. Disassembly and reassembly of the fitting can be made without loss of strength or sealing qualities.

In general, the "bite-action" of the sleeves in any given material varies as shown in the following table:

"7000" Series Sleeve	Sleeve Material	Tubing used 303 to 316 Stainless and Cupro-Nickel	"Bite-action"
7165	Heat treated carbon steel (Standard carbon)	Fully annealed to 1/8 hard	Excellent

7000 series Ermeto fittings assembly instructions

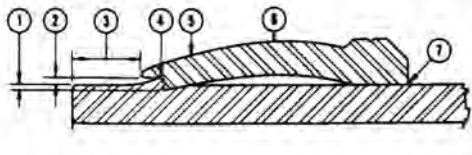
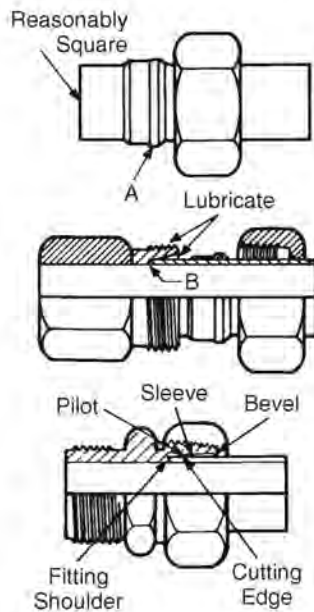

Presetting operation

Preset with preset tool:

1. Slide nut and then sleeve on tube. Shoulder of sleeve "A" must be toward nut.
2. Insert tube into presetting tool. Be sure that tube is bottomed on fitting tube stop at point "B". Lubricate threads, seat of fitting and shoulder of sleeve with good grade of lubricant.
3. Turn nut slowly with wrench while turning tube with other hand. When the sleeve grips the tube, that is, when the tube can no longer be turned by hand - STOP - and note the position of the wrench. This is the "Ring Grip" point.
4. Tighten nut an additional number of turns past the ring grip point per tube size and wall thickness as shown in Table 1, page J-142.
5. Disassemble from preset tool.

Preset in fitting body:

Follow same procedure as when presetting with preset tool. Once the fitting nut has been turned the proper number of turns past ring grip, the fitting assembly is complete and ready for use.

Fitting installation

1. After sleeve and nut have been preset on the tubing and checked as described, the assembly is ready for installation into the Ermeto fitting seat.
2. Lubricate threads, seat of fitting and shoulder of sleeve with a good grade of lubricant compatible with system fluid.
3. Insert tube assembly into fitting and tighten nut until sharp rise in torque is felt.
4. Starting at the position of sharp torque rise, tighten nut 1/4 turn to complete assembly.

When the assembly procedure for Ermeto fittings is followed correctly, these points will be evident:

1. Cutting edge of sleeve will be imbedded in tubing to its full depth.
2. Pilot edge of sleeve should be close to or touching O.D. of tubing.
3. Distance between end of tube and leading or pilot edge of sleeve will be at least 1/8".
4. Metal will be piled ahead of cutting edge of sleeve under pilot.
5. Contact area of sleeve will show evidence of being in perfect contact with tapered seat of fitting.
6. Sleeve will show evidence of being bowed within its elastic limits.
7. Back of sleeve will be in contact with tube.

Note: Performance of fitting will not be affected if sleeve rotates on tube after disassembly.

For re-installation of fitting after disassembly

1. Insert tube assembly into fitting, tighten nut until a sharp rise in torque is felt.
2. Starting at the position of sharp torque rise, tighten nut 1/4 turn to complete the re-installation.

Steel adapters

Presetting Ermeto fittings

J

Presetting Ermeto fittings

Table 1: Number of additional turns from “Ring grip” for hand presetting operation—Ermeto sleeve

Tube Size	Tube Material**	Tube wall thickness									
		.018	.022	.028	.035	.049	.065	.083	.095	.109	.120
2	C 1010	1-1/6	1-1/6	1-1/6	1-1/6						
	MiL-T-8504	1-1/6	1-1/6	1-1/6	1-1/6						
3	C 1010	1-1/6	1-1/6	1-1/6	1						
	MiL-T-8504	1-1/6	1-1/6	1-1/6	1						
4	C 1010			1-1/6	1-1/6	1-1/6	1				
	MiL-T-8504			1-1/6	1	1	5/6				
5	C 1010			1-1/6	1-1/6	1-1/6	1				
	MiL-T-8504			1-1/6	1-1/6	1	1				
6	C 1010				1-1/6	1-1/6	1	1			
	MiL-T-8504				1-1/6	5/6	5/6	1			
8	C 1010				1-1/6	1-1/6	1	1	1		
	MiL-T-8504				1-1/6	1	5/6	5/6	5/6		
10	C 1010					1-1/6	1	5/6	5/6	5/6	5/6
	MiL-T-8504					1-1/6	1	5/6	5/6	5/6	5/6
12	C 1010					1	1	5/6	5/6	5/6	
	MiL-T-8504					1-1/6	1	5/6	5/6	5/6	
16	C 1010					1-1/6	1-1/6	5/6	5/6	5/6	
	MiL-T-8504					1-1/6	1-1/6	5/6	5/6	5/6	
20	C 1010					1-1/6	1	1	1	5/6	5/6
	MiL-T-8504					1	1	1	1	5/6	5/6
24	C 1010								1	1	1
	MiL-T-8504								1	1	1
32	C 1010								1	1	1
	MiL-T-8504								1	1	1

** C 1010 – carbon steel tubing

** MiL-T-8504 – Annealed stainless steel

Ermeto hand presetting tools 7000 series



Presetting tools provide a more accurate and positive leak-proof method of coupling flareless fittings. Presetting steel Ermeto sleeves on tubing prior to fitting assembly will permit the maximum high performance obtainable with flareless fittings.

Catalog number	Tube O.D.	Thread size
	inches	
T-7002	1/8	5/16-24
T-7003	3/16	3/8-24
T-7004	1/4	7/16-20
T-7005	5/16	1/2-20
T-7006	3/8	9/16-18
T-7008	1/2	3/4-16
T-7010	5/8	7/8-14
T-7012	3/4	1 1/16-12
T-7016	1	1 5/16-12
T-7020	1 1/4	1 5/8-12
T-7024	1 1/2	1 7/8-12
T-7032	2	2 1/2-12

Ermeto flareless fittings

Hydraulic pressure data

Ermeto fittings have been used with success on many and varied applications far exceeding the conservative conditions presented below. Specifically:

- Temperatures up to 800°F, in carbon steel have been handled without failure
- Burst pressures up to 32,000 psi with 1/4" tubing
- Vibration conditions of 1/8" off-center amplitude with 12" overhang in 1/4" tubing have been withstood at rated operating pressure with 4-to-1 safety factors for over ten million cycles

Obviously under extreme conditions of pressure, temperature and/or vibration, the safety factor is proportionately reduced.

The Ermeto flareless fitting is the ultimate hydraulic fitting available today. Special performance conditions as outlined can be accommodated; however, it is recommended that your local Eaton representative be consulted for engineering assistance prior to finalizing design.

The values shown in the following table are pressure ratings of Ermeto flareless fittings under various surge conditions. They apply and are recommended for conservative operating conditions.

Size no.	Size in inches	Maximum pressure † No surges PSI	Maximum pressure † With surges to 50%	Maximum pressure † With surges of 50% to 100%	Maximum pressure † With surges to 150%
2	1/8	10,000	6,500	5,000	4,000
3	3/16	9,000	6,000	4,500	3,600
4	1/4	8,000	5,250	4,000	3,200
5	5/16	8,000	5,250	4,000	3,200
6	3/8	7,500	5,000	3,750	3,000
8	1/2	7,000	4,500	3,500	2,700
10	5/8	5,000	3,250	2,500	2,000
12	3/4	5,000	3,250	2,500	2,000
14	7/8	3,750	2,500	1,800	1,500
16	1	3,600	2,400	1,800	1,400
20	1 1/4	3,200	2,100	1,600	1,275
24	1 1/2	3,000	2,000	1,500	1,200
32	2	2,750	1,800	1,350	1,100

†Pressures shown do not apply to pneumatic applications.

Steel adapters

Ermeto

J

Ermeto

Sleeve

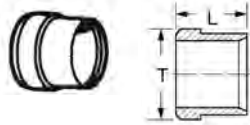

7165x (Ref. SAE No. 080115B)

Part number	Tube O.D.	L	Dia. T
7165x2	1/8	0.28	0.20
7165x3	3/16	0.28	0.31
7165x4	1/4	0.34	0.36
7165x5	5/16	0.34	0.42
7165x6	3/8	0.38	0.48
7165x8	1/2	0.38	0.63
7165x10	5/8	0.42	0.75
7165x12	3/4	0.42	0.88
7165x14	7/8	0.42	1.00
7165x16	1	0.42	1.13
7165x20	1 1/4	0.42	1.41
7165x24	1 1/2	0.42	1.66
7165x32	2	0.45	2.19

Sleeve

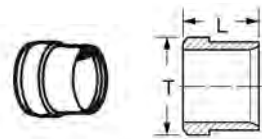

8165x

Part number	Tube O.D.	L	Dia. T
8165x4	1/4	0.34	0.38
8165x5	5/16	0.34	0.44
8165x6	3/8	0.38	0.50

For use with 8112x diesel nuts only.

Nut

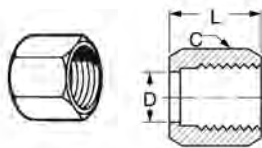

7105x (Ref. SAE No. 080110)

Part number	Tube O.D.	Hex C	L	D Dia
7105x2	1/8	3/8	0.53	0.132
7105x3	3/16	7/16	0.61	0.195
7105x4	1/4	9/16	0.70	0.257
7105x5	5/16	5/8	0.72	0.320
7105x6	3/8	1 1/16	0.75	0.382
7105x8	1/2	7/8	0.84	0.508
7105x10	5/8	1	0.92	0.634
7105x12	3/4	1 1/4	0.97	0.759
7105x14	7/8	1 3/8	1.00	0.884
7105x16	1	1 1/2	1.05	1.009
7105x20	1 1/4	2	1.05	1.263
7105x24	1 1/2	2 1/4	1.03	1.513
7105x32	2	2 7/8	1.12	2.017

Diesel nut

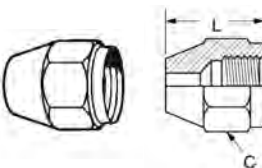

8112x

Part number	Tube O.D.	Thread number	Hex C	L
8112x4	1/4	9/16-18	3/4	.94
8112x5	5/16	5/8-18	1 3/16	1.00
8112x6	3/8	3/4-16	1 5/16	1.13

For use with 8165x sleeve only.

Note: All measurements are in inches.

Ermeto

Cap

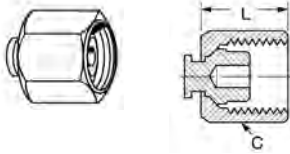

7129x (Ref. SAE No. 080112)

Part number	Tube O.D	Hex C	L
7129x4	1/4	9/16	0.70
7129x6	3/8	1 1/16	0.75
7129x8	1/2	7/8	0.84
7129x10	5/8	1	0.92
7129x12	3/4	1 1/4	0.97
7129x16	1	1 1/2	1.05
7129x20	1 1/4	2	1.05

Plug

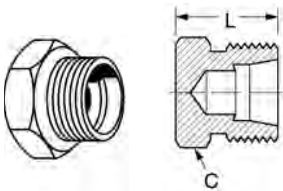

7229x (Ref. SAE No. 080109)

Part number	Tube O.D	Hex C	L
7229x2	1/8	7/16	0.63
7229x4	1/4	1/2	0.71
7229x5	5/16	9/16	0.71
7229x6	3/8	5/8	0.75
7229x8	1/2	1 3/16	0.85
7229x10	5/8	1 5/16	0.97
7229x12	3/4	1 1/8	1.10
7229x16	1	1 3/8	1.10

Reducer

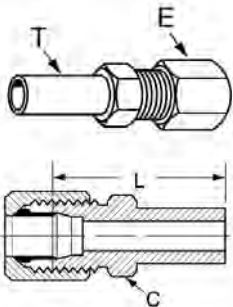

7015x (Ref. SAE No. 080123)

Part number	Body size T	Tube size	Hex C	L
7015x6x4	3/8	1/4	1/2	1.61
7015x8x4	1/2	1/4	9/16	1.73
7015x8x6	1/2	3/8	5/8	1.77
7015x10x8	5/8	1/2	1 3/16	1.96
7015x12x6	3/4	3/8	1 3/16	1.93
7015x12x8	3/4	1/2	1 3/16	2.03
7015x20x16	1 1/4	1	1 3/8	2.28

Note: All measurements are in inches.

Steel adapters

Ermeto

J

Ermeto

Small hex union

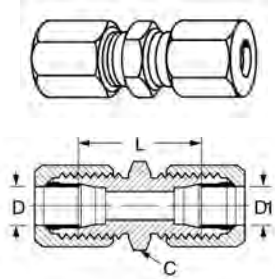

7305x (Ref. SAE No. 080101)

Part number	Tube O.D.	Hex C	D	D1	L
7305x2	1/8	7/16	0.093	0.093	1.02
7305x3	3/16	7/16	0.125	0.125	1.11
7305x4	1/4	1/2	0.203	0.203	1.18
7305x5	5/16	9/16	0.234	0.234	1.18
7305x6	3/8	5/8	0.281	0.281	1.24
7305x6x4	3/8 & 1/4	5/8	0.281	0.203	1.22
7305x8	1/2	13/16	0.422	0.422	1.42
7305x8x6	1/2 & 3/8	13/16	0.422	0.281	1.33
7305x10	5/8	15/16	0.500	0.500	1.61
7305x12	3/4	1 1/8	0.656	0.656	1.81
7305x14	7/8	1 1/4	0.718	0.718	1.81
7305x16	1	1 3/8	0.875	0.875	1.81
7305x20	1 1/4	1 11/16	1.093	1.093	1.89
7305x24	1 1/2	2	1.344	1.344	1.96

Large hex union

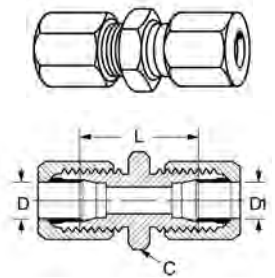

7306x (Ref. SAE No. 080119)

Part number	Tube O.D.	Hex C	D	D1	L
7306x4	1/4	11/16	0.203	0.203	1.18
7306x6	3/8	13/16	0.281	0.281	1.24
7306x8	1/2	1	0.422	0.281	1.33
7306x8x6	1/2 & 3/8	1	0.422	0.422	1.42
7306x12	3/4	1 3/8	0.656	0.656	1.81
7306x16	1	1 5/8	0.875	0.875	1.81

Bulkhead union

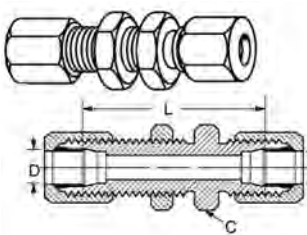

7325x (Ref. SAE No. 080601)

Bulkhead nut included, for replacement nuts use 210212-

Part number	Tube O.D.	Hex C	D	L
7325x4	1/4	11/16	0.203	1.89
7325x6	3/8	13/16	0.281	1.98
7325x8	1/2	1	0.422	2.22
7325x12	3/4	1 3/8	0.656	2.72
7325x16	1	1 5/8	0.875	2.72

Note: All measurements are in inches.

Ermeto

Male connector

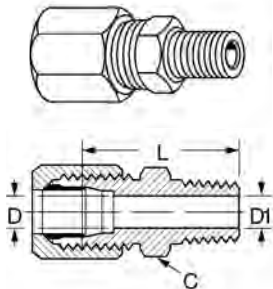
**7205x** (Ref. SAE No. 080102)

Part number	Tube O.D.	Male pipe thread	Hex C	D1 D	Opt.	L
7205x2	1/8	1/8-27	7/16	0.093	0.188	1.04
7205x2X4	1/8	1/4-18	9/16	0.093	0.281	1.25
7205x3	3/16	1/8-27	7/16	0.125	0.188	1.09
7205x4	1/4	1/8-27	1/2	0.203	0.188	1.12
7205x4X4	1/4	1/4-18	9/16	0.203	0.281	1.32
7205x4X6	1/4	3/8-18	3/4	0.203	0.406	1.33
7205x4X8	1/4	1/2-14	7/8	0.203	0.531	1.58
7205x5	5/16	1/8-27	9/16	0.234	0.188	1.12
7205x5X4	5/16	1/4-18	9/16	0.234	0.281	1.32
7205x6	3/8	1/4-18	5/8	0.281	0.281	1.34
7205x6X2	3/8	1/8-27	5/8	0.281	0.188	1.15
7205x6X6	3/8	3/8-18	3/4	0.281	0.406	1.35
7205x6X8	3/8	1/2-14	7/8	0.281	0.531	1.60
7205x8	1/2	3/8-18	13/16	0.422	0.406	1.44
7205x8X4	1/2	1/4-18	13/16	0.422	0.281	1.44
7205x8X8	1/2	1/2-14	7/8	0.422	0.531	1.69
7205x8X12	1/2	3/4-14	1 1/8	0.422	0.719	1.76
7205x10	5/8	1/2-14	15/16	0.500	0.531	1.75
7205x10X6	5/8	3/8-18	15/16	0.500	0.406	1.56
7205x12	3/4	1/2-14	1 1/8	0.656	0.531	1.88
7205x12X8	3/4	3/4-14	1 1/8	0.656	0.719	1.88
7205x14	7/8	3/4-14	1 1/4	0.718	0.719	1.88
7205x16	1	1-11 1/2	1 3/8	0.875	0.938	2.07
7205x16X12	1	3/4-14	1 3/8	0.875	0.719	1.88
7205x20	1 1/4	1 1/4-11 1/2	1 11/16	1.093	1.250	2.18
7205x24	1 1/2	1 1/2-11 1/2	2	1.344	1.500	2.28

Female connector

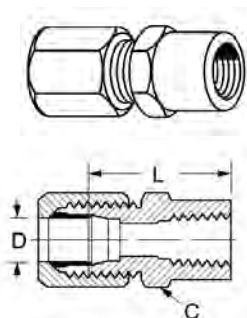
**7255x** (Ref. SAE No. 080103)

Part number	Tube O.D.	Female pipe thread	Hex C	D	L
7255x2	1/8	1/8-27	9/16	0.093	1.05
7255x3	3/16	1/8-27	9/16	0.125	1.08
7255x4	1/4	1/8-27	9/16	0.203	1.09
7255x4x4	1/4	1/4-18	3/4	0.203	1.20
7255x5	5/16	1/8-27	9/16	0.234	1.08
7255x6	3/8	1/4-18	3/4	0.281	1.31
7255x6x6	3/8	3/8-18	7/8	0.281	1.40
7255x8	1/2	3/8-18	7/8	0.422	1.47
7255x8x4	1/2	1/4-18	7/8	0.422	1.38
7255x8x8	1/2	1/2-14	1 1/8	0.422	1.63
7255x10	5/8	1/2-14	1 1/8	0.500	1.76
7255x12	3/4	3/4-14	1 3/8	0.656	1.89
7255x14	7/8	3/4-14	1 3/8	0.718	1.86
7255x16	1	1-11 1/2	1 5/8	0.875	2.13
7255x20	1 1/4	1 1/4-11 1/2	2	1.093	2.22

Note: All measurements are in inches.

Steel adapters

Ermeto

J

Ermeto

Straight thread O-Ring connector

7315x (Ref. SAE No. 080120)

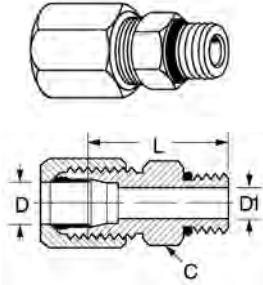

Part number	Tube O.D.	Port size	Hex C	D	L	D1 opt.
7315x4	1/4	1/4	9/16	0.203	1.13	-
7315x4x5	1/4	5/16	5/8	0.203	1.13	-
7315x4x6	1/4	3/8	11/16	0.203	1.19	0.281
7315x5	5/16	5/16	5/8	0.234	1.13	-
7315x6	3/8	3/8	11/16	0.281	1.21	-
7315x6x8	3/8	1/2	7/8	0.281	1.29	0.422
7315x8	1/2	1/2	7/8	0.422	1.38	-
7315x8x10	1/2	5/8	1	0.422	1.51	0.500
7315x8x12	1/2	3/4	1 1/4	0.422	1.67	0.656
7315x10	5/8	5/8	1	0.500	1.57	-
7315x12	3/4	3/4	1 1/4	0.656	1.79	-
7315x16	1	1	1 1/2	0.875	1.82	-
7315x16x12	1	3/4	1 1/2	0.875	1.82	0.656
7315x20	1 1/4	1 1/4	1 7/8	1.093	1.90	-

45° male elbow

7355x (Ref. SAE No. 080302)

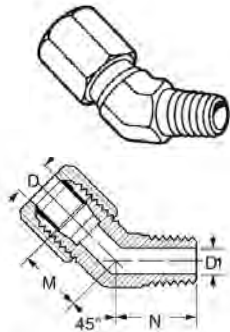

Part number	Tube O.D.	Male pipe thread	D	D1	M	N	Across flats
7355x4x4	1/4	1/4-18	0.203	0.281	0.83	0.86	9/16
7355x6	3/8	1/4-18	0.281	0.281	0.83	0.86	9/16
7355x8	1/2	3/8-18	0.422	0.406	0.98	0.95	3/4
7355x10	5/8	1/2-14	0.500	0.531	1.08	1.17	7/8
7355x12	3/4	3/4-14	0.656	0.719	1.27	1.20	1 1/16
7355x16	1	1-11 1/2	0.875	0.938	1.36	1.48	1 5/16

90° union elbow

7505x (Ref. SAE No. 080201)

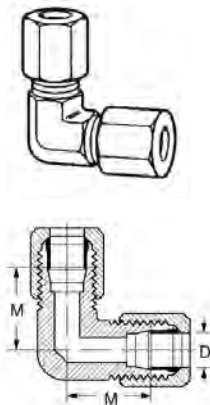

Part number	Tube O.D.	D	M	Across flats
7505x4	1/4	0.203	0.89	7/16
7505x5	5/16	0.234	0.95	1/2
7505x6	3/8	0.281	1.05	9/16
7505x8	1/2	0.422	1.25	3/4
7505x10	5/8	0.500	1.42	7/8
7505x12	3/4	0.656	1.58	1 1/16
7505x14	7/8	0.718	1.66	1 5/16
7505x16	1	0.875	1.73	1 5/16
7505x20	1 1/4	1.093	1.89	1 5/8
7505x24	1 1/2	1.346	2.02	1 7/8

Note: Available in stainless steel. All measurements are in inches.

Ermeto

90° male elbow

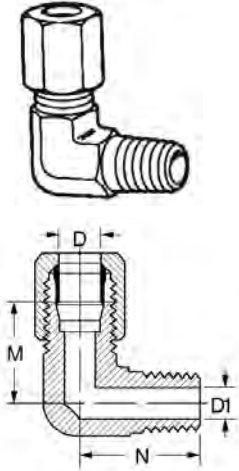
**7405x** (Ref. SAE No. 080202)

Part number	Tube O.D.	Male Pipe thread	D	D1	M	N	Across flats
7405x2	1/8	1/8-27	0.093	0.188	0.77	0.72	7/16
7405x3	3/16	1/8-27	0.125	0.188	0.83	0.72	7/16
7405x4	1/4	1/8-27	0.203	0.188	0.89	0.78	7/16
7405x4x4	1/4	1/4-18	0.203	0.281	1.03	1.09	9/16
7405x5	5/16	1/8-27	0.234	0.188	0.95	0.81	1/2
7405x5x4	5/16	1/4-18	0.234	0.281	1.03	1.09	9/16
7405x6	3/8	1/4-18	0.281	0.281	1.05	1.09	9/16
7405x6x2	3/8	1/8-27	0.281	0.188	1.05	0.90	9/16
7405x6x6	3/8	3/8-18	0.281	0.406	1.16	1.22	3/4
7405x6x8	3/8	1/2-14	0.281	0.531	1.24	1.47	7/8
7405x8	1/2	3/8-18	0.422	0.406	1.25	1.22	3/4
7405x8x4	1/2	1/4-18	0.422	0.281	1.25	1.22	3/4
7405x8x8	1/2	1/2-14	0.422	0.531	1.35	1.47	7/8
7405x10	5/8	1/2-14	0.500	0.531	1.42	1.47	7/8
7405x10x6	5/8	3/8-18	0.500	0.406	1.42	1.28	7/8
7405x12	3/4	3/4-14	0.656	0.719	1.58	1.59	1 1/16
7405x12x8	3/4	1/2-14	0.656	0.531	1.58	1.59	1 1/16
7405x14	7/8	3/4-14	0.718	0.719	1.62	1.69	1 5/16
7405x16	1	1-11 1/2	0.875	0.938	1.73	1.97	1 5/16
7405x16x12	1	3/4-14	0.875	0.719	1.73	1.78	1 5/16
7405x20	1 1/4	1 1/4-11 1/2	1.093	1.250	1.89	2.38	1 5/8
7405x24	1 1/2	1 1/2-11 1/2	1.344	1.500	2.02	2.64	1 7/8

90° female elbow

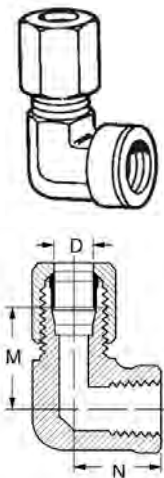
**7455x** (Ref. SAE No. 080203)

Part number	Tube O.D.	Female Pipe thread	D	M	N	Across flats
7455x4	1/4	1/8-27	0.203	0.89	0.66	9/16
7455x4x4	1/4	1/4-18	0.203	1.03	0.88	3/4
7455x6	3/8	1/4-18	0.281	1.05	0.88	3/4
7455x6x6	3/8	3/8-18	0.281	1.14	1.02	7/8
7455x8	1/2	3/8-18	0.422	1.23	1.02	7/8
7455x8x8	1/2	1/2-14	0.422	1.35	1.23	1 1/16
7455x10	5/8	1/2-14	0.500	1.42	1.23	1 1/16
7455x12	3/4	3/4-14	0.656	1.58	1.36	1 5/16
7455x14	7/8	3/4-14	0.718	1.66	1.42	1 5/16
7455x16	1	1-11 1/2	0.875	1.73	1.62	1 5/8

Note: All measurements are in inches.

Steel adapters

Ermeto

J

Ermeto

90° elbow - straight thread O-Ring

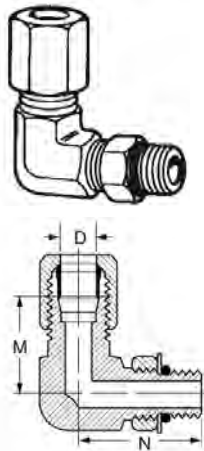

7515x (Ref. SAE No. 080220)

Part number	Tube O.D.	Port size	D	M	N	Across flats
7515x4	1/4	1/4	0.203	0.89	1.03	7/16
7515x5	5/16	5/16	0.234	0.96	2.13	9/16
7515x6	3/8	3/8	0.281	1.05	1.25	9/16
7515x8	1/2	1/2	0.422	1.25	1.45	3/4
7515x10	5/8	5/8	0.500	1.42	1.70	7/8
7515x12	3/4	3/4	0.656	1.58	1.94	1 1/16
7515x16	1	1	0.875	1.73	2.05	1 5/16
7515x20	1 1/4	1 1/4	1.093	1.89	2.25	1 5/8

Union tee

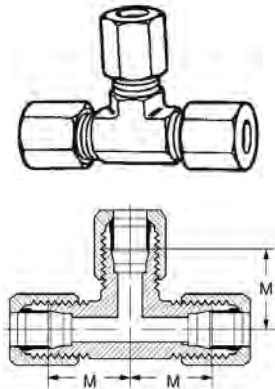

7705x (Ref. SAE No. 080401)

Part number	Tube O.D.	D	M	Across flats
7705x3	3/16	0.125	0.83	7/16
7705x4	1/4	0.203	0.89	7/16
7705x5	5/16	0.234	0.95	9/16
7705x6	3/8	0.281	1.05	9/16
7705x8	1/2	0.422	1.25	3/4
7705x10	5/8	0.500	1.42	7/8
7705x12	3/4	0.656	1.58	1 1/16
7705x14	7/8	0.718	1.62	1 5/16
7705x16	1	0.875	1.73	1 5/16

Male run tee

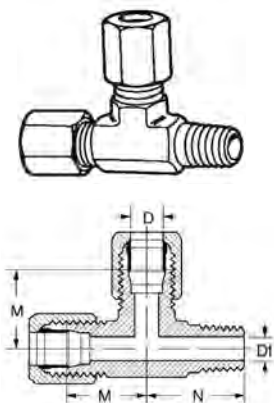

7755x (Ref. SAE No. 080424)

Part number	Tube O.D.	Male pipe thread	D	D1	M	N	Across flats
7755x4	1/4	1/8-27	0.203	0.188	0.89	0.78	7/16
7755x4x4x4	1/4	1/4-18	0.203	0.281	1.03	1.09	9/16
7755x6	3/8	1/4-18	0.281	0.281	1.05	1.09	9/16
7755x8	1/2	3/8-18	0.422	0.422	1.25	1.22	3/4
7755x8x8x8	1/2	1/2-14	0.422	0.531	1.35	1.47	7/8
7755x10	5/8	1/2-14	0.500	0.531	1.42	1.47	7/8
7755x12	3/4	3/4-14	0.656	0.719	1.58	1.59	1 1/16
7755x16	1	1-11 1/2	0.875	0.938	1.73	1.97	1 5/16

Note: All measurements are in inches.

Ermeto

Female run tee

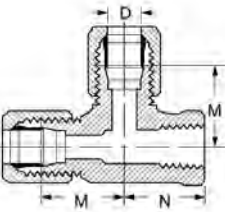
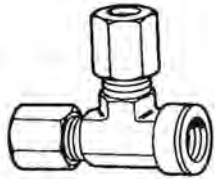
**7805x** (Ref SAE No. 080426)

Part number	Tube O.D.	Female pipe thread	D	M	N	Across flats
7805x4	1/4	1/8-27	0.203	0.89	0.66	9/16
7805x4x4x4	1/4	1/4-18	0.200	1.03	0.88	3/4
7805x6	3/8	1/4-18	0.281	1.05	0.88	3/4
7805x8	1/2	3/8-18	0.422	1.23	1.02	7/8
7805x10	5/8	1/2-14	0.500	1.42	1.23	1

Straight thread O-Ring run tee

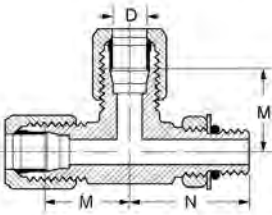
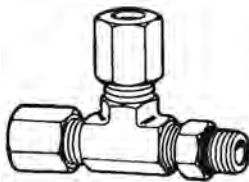
**7716x** (Ref. SAE No. 080428)

Part number	Tube O.D.	Port size	D	M	N	Across flats
7716x4	1/4	1/4	0.203	0.89	1.03	7/16
7716x6	3/8	3/8	0.281	1.05	1.25	9/16
7716x8	1/2	1/2	0.420	1.25	1.45	3/4

Note: All measurements are in inches.

Steel adapters

Ermeto

J

Ermeto

Male branch tee

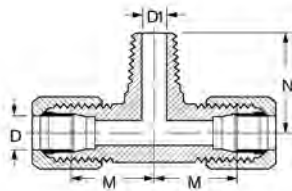
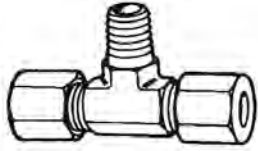

7605x (Ref. SAE No. 080425)

Part number	Tube O.D.	Male pipe thread	D	D1	M	N	Across flats
7605x4	1/4	1/8-27	0.203	0.188	0.89	0.78	7/16
7605x4x4x4	1/4	1/4-18	0.203	0.281	1.03	1.09	9/16
7605x6	3/8	1/4-18	0.281	0.281	1.05	1.09	9/16
7605x8	1/2	3/8-18	0.422	0.406	1.25	1.22	3/4
7605x8x8x8	1/2	1/2-14	0.422	0.531	1.35	1.47	7/8
7605x10	5/8	1/2-14	0.500	0.531	1.42	1.47	7/8
7605x12	3/4	3/4-14	0.656	0.719	1.58	1.59	1 1/16
7605x16	1	1-11 1/2	0.875	0.938	1.73	1.97	1 5/16

Female branch tee

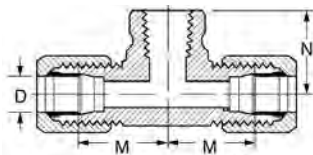
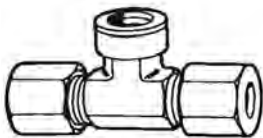

7655x (Ref. SAE No. 080427)

Part number	Tube O.D.	Female pipe thread	D	M	N	Across flats
7655x4	1/4	1/8-27	0.203	0.89	0.66	9/16
7655x4x4x4	1/4	1/4-18	0.203	1.03	0.88	3/4
7655x6	3/8	1/4-18	0.281	1.05	0.88	3/4
7655x8	1/2	3/8-18	0.422	1.23	1.02	7/8
7655x10	5/8	1/2-14	0.500	1.42	1.23	1 1/16
7655x12	3/4	3/4-14	0.656	1.58	1.36	1 5/16
7655x16	1	1-11 1/2	0.875	1.73	1.62	1 5/8

Note: All measurements are in inches.

Part number catalog cross referencing index

Former WH Part Number	Eaton Part Number	Catalog Page
C5105X10	1290-10S	J-127
C5105X12	1290-12S	J-127
C5105X14	1290-14S	J-127
C5105X16	1290-16S	J-127
C5105X20	1290-20S	J-127
C5105X24	1290-24S	J-127
C5105X2	1290-2S	J-127
C5105X32	1290-32S	J-127
C5105X3	1290-3S	J-127
C5105X4	1290-4S	J-127
C5105X5	1290-5S	J-127
C5105X6	1290-6S	J-127
C5105X8	1290-8S	J-127
MC5206X8X10	15.063-10-8	J-131
MC5206X8X12	15.063-12-8	J-131
MC5206X10X15	15.063-15-10	J-131
MC5206X12X18	15.063-18-12	J-131
MC5206X4X6	15.063-6-4	J-131
MC5206X6X8	15.063-8-6	J-131
MC5207X8X12	15.117-10-8	J-131
MC5207X12X18	15.117-16-12	J-131
MC5207x20x28	15.117-25-20	J-131
MC5207X4X6	15.117-4-4	J-131
MC5207X6X8	15.117-6-6	J-131
MC5207X6X10	15.117-8-6	J-131
MC5207X8X10	15.117-8-8	J-131
MC5208X8X10	15.147-10-8	J-131
MC5208X10X14	15.147-14-10	J-131
MC5208X12X16	15.147-16-12	J-131
MC5208X16X20	15.147-20-16	J-131
MC5208X6X6	15.147-6-6	J-131
C9240	2004-12-16S	J-128
C9200	2004-16-16S	J-128
9100X12X12	2018-12-12S	J-79
9100X16X12	2018-12-16S	J-79
9100X16X16	2018-16-16S	J-79
9100X4X2	2018-2-4S	J-79
9100X20X20	2018-20-20S	J-79
9100X4X4	2018-4-4S	J-79
9100X5X4	2018-4-5S	J-79
9100X6X4	2018-4-6S	J-79
9100X10X6	2018-6-10S	J-79
9100X6X6	2018-6-6S	J-79
9100X8X6	2018-6-8S	J-79
9100X10X8	2018-8-10S	J-79
9100X12X8	2018-8-12S	J-79
9100X8X8	2018-8-8S	J-79
C5955X12	2020-12-12S	J-102
C5955X16	2020-16-16S	J-102
C5955X4	2020-4-4S	J-102
C5955X6	2020-6-6S	J-102
C5955X8	2020-8-8S	J-102
C5205X10X12	2021-12-10S	J-77
C5205X12	2021-12-12S	J-77
C5205X14	2021-12-14S	J-77
C5205x16X12	2021-12-16S	J-77
C5205X6X12	2021-12-6S	J-77
C5205X8X12	2021-12-8S	J-77
C5205X12X16	2021-16-12S	J-77
C5205X16	2021-16-16S	J-77
C5205X20X16	2021-16-20S	J-77
C5205X24X16	2021-16-24S	J-77
C5205X2	2021-2-2S	J-77
C5205X3	2021-2-3S	J-77
C5205X4	2021-2-4S	J-77
C5205X5	2021-2-5S	J-77
C5205X6X2	2021-2-6S	J-77

Former WH Part Number	Eaton Part Number	Catalog Page
C5205X8X2	2021-2-8S	J-77
C5205X12X20	2021-20-12S	J-77
C5205X16X20	2021-20-16S	J-77
C5205X20	2021-20-20S	J-77
C5205X24X20	2021-20-24S	J-77
C5205X12X24	2021-24-12S	J-77
C5205X16X24	2021-24-16S	J-77
C5205X20X24	2021-24-20S	J-77
C5205X24	2021-24-24S	J-77
C5205X32X24	2021-24-32S	J-77
C5205X32	2021-32-32S	J-77
C5205X4X4	2021-4-4S	J-77
C5205X5X4	2021-4-5S	J-77
C5205X6	2021-4-6S	J-77
C5205X8X4	2021-4-8S	J-77
C5205X10X6	2021-6-10S	J-77
C5205X4X6	2021-6-4S	J-77
C5205X5X6	2021-6-5S	J-77
C5205X6X6	2021-6-6S	J-77
C5205X8	2021-6-8S	J-77
C5205X10	2021-8-10S	J-77
C5205X12X8	2021-8-12S	J-77
C5205X4X8	2021-8-4S	J-77
C5205X6X8	2021-8-6S	J-77
C5205X8X8	2021-8-8S	J-77
C5880X3	202124-3-3S	J-128
C5880X4X3	202124-3-4S	J-128
C5880X4	202124-4-4S	J-128
C5880X5	202124-5-5S	J-128
C5880X6	202124-6-6S	J-128
C5880X8	202124-8-8S	J-128
C5255X10X12	2022-12-10S	J-80
C5255X12	2022-12-12S	J-80
C5255X16X12	2022-12-16S	J-80
C5255X8X12	2022-12-8S	J-80
C5255X12X16	2022-16-12S	J-80
C5255X16	2022-16-16S	J-80
C5255X2	2022-2-2S	J-80
C5255X3	2022-2-3S	J-80
C5255X4	2022-2-4S	J-80
C5255X5	2022-2-5S	J-80
C5255X16X20	2022-20-16S	J-80
C5255X20	2022-20-20S	J-80
C5255X24	2022-24-24S	J-80
C5255X32	2022-32-32S	J-80
C5255X3X4	2022-4-3S	J-80
C5255X4X4	2022-4-4S	J-80
C5255X5X4	2022-4-5S	J-80
C5255X6	2022-4-6S	J-80
C5255X8X4	2022-4-8S	J-80
C5255X10X6	2022-6-10S	J-80
C5255X6X6	2022-6-6S	J-80
C5255X8	2022-6-8S	J-80
C5255X10	2022-8-10S	J-80
C5255X12X8	2022-8-12S	J-80
C5255X6X8	2022-8-6S	J-80
C5255X8X8	2022-8-8S	J-80
C5355X10X12	2023-12-10S	J-81
C5355X12	2023-12-12S	J-81
C5355X16X12	2023-12-16S	J-81
C5355X8X12	2023-12-8S	J-81
C5355X12X16	2023-16-12S	J-81
C5355X16	2023-16-16S	J-81
C5355X20X16	2023-16-20S	J-81
C5355X3	2023-2-3S	J-81
C5355X4	2023-2-4S	J-81
C5355X5	2023-2-5S	J-81

Part number catalog cross referencing index

Former WH Part Number	Eaton Part Number	Catalog Page
C5355X6X2	2023-2-6S	J-81
C5355X24	2023-24-24S	J-81
C5355X32	2023-32-32S	J-81
C5355X4X4	2023-4-4S	J-81
C5355X5X4	2023-4-5S	J-81
C5355X6	2023-4-6S	J-81
C5355X8X4	2023-4-8S	J-81
C5355X10X6	2023-6-10S	J-81
C5355X4X6	2023-6-4S	J-81
C5355X6X6	2023-6-6S	J-81
C5355X8	2023-6-8S	J-81
C5355X10	2023-8-10S	J-81
C5355X12X8	2023-8-12S	J-81
C5355X6X8	2023-8-6S	J-81
C5355X8X8	2023-8-8S	J-81
C5405X10X12	2024-12-10S	J-82
C5405X12	2024-12-12S	J-82
C5405X16X12	2024-12-16S	J-82
C5405X6X12	2024-12-6S	J-82
C5405X8X12	2024-12-8S	J-82
C5405X12X16	2024-16-12S	J-82
C5405X16	2024-16-16S	J-82
C5405X20X16	2024-16-20S	J-82
C5405X3	2024-2-3S	J-82
C5405X4	2024-2-4S	J-82
C5405X5	2024-2-5S	J-82
C5405X6X2	2024-2-6S	J-82
C5405X16X20	2024-20-16S	J-82
C5405X20	2024-20-20S	J-82
C5405X24X20	2024-20-24S	J-82
C5405X20X24	2024-24-20S	J-82
C5405X24	2024-24-24S	J-82
C5405X32X24	2024-24-32S	J-82
C5405X32	2024-32-32S	J-82
C5405X4X4	2024-4-4S	J-82
C5405X5X4	2024-4-5S	J-82
C5405X6	2024-4-6S	J-82
C5405X8X4	2024-4-8S	J-82
C5405X10X6	2024-6-10S	J-82
C5405X12X6	2024-6-12S	J-82
C5405X4X6	2024-6-4S	J-82
C5405X5X6	2024-6-5S	J-82
C5405X6X6	2024-6-6S	J-82
C5405X8	2024-6-8S	J-82
C5405X10	2024-8-10S	J-82
C5405X12X8	2024-8-12S	J-82
C5405X16X8	2024-8-16S	J-82
C5405X4X8	2024-8-4S	J-82
C5405X6X8	2024-8-6S	J-82
C5405X8X8	2024-8-8S	J-82
C5425X12	202411-12-12S	J-83
C5425X16X12	202411-12-16S	J-83
C5425X16	202411-16-16S	J-83
C5425X4	202411-2-4S	J-83
C5425X20	202411-20-20S	J-83
C5425X4X4	202411-4-4S	J-83
C5425X6	202411-4-6S	J-83
C5425X6X6	202411-6-6S	J-83
C5425X8	202411-6-8S	J-83
C5425X10	202411-8-10S	J-83
C5425X8X8	202411-8-8S	J-83
C5435X12	202413-12-12S	J-83
C5435X16X12	202413-12-16S	J-83
C5435X16	202413-16-16S	J-83
C5435X4	202413-2-4S	J-83
C5435X20	202413-20-20S	J-83
C5435X4X4	202413-4-4S	J-83

Former WH Part Number	Eaton Part Number	Catalog Page
C5435X5X4	202413-4-5S	J-83
C5435X6	202413-4-6S	J-83
C5435X6X6	202413-6-6S	J-83
C5435X8	202413-6-8S	J-83
C5435X10	202413-8-10S	J-83
C5435X12X8	202413-8-12S	J-83
C5435X8X8	202413-8-8S	J-83
C5455X12	2025-12-12S	J-85
C5455X16	2025-16-16S	J-85
C5455X4	2025-2-4S	J-85
C5455X5	2025-2-5S	J-85
C5455X6X2	2025-2-6S	J-85
C5455X20	2025-20-20S	J-85
C5455X24	2025-24-24S	J-85
C5455X4X4	2025-4-4S	J-85
C5455X5X4	2025-4-5S	J-85
C5455X6	2025-4-6S	J-85
C5455X8X4	2025-4-8S	J-85
C5455X4X6	2025-6-4S	J-85
C5455X6X6	2025-6-6S	J-85
C5455X8	2025-6-8S	J-85
C5455X10	2025-8-10S	J-85
C5455X12X8	2025-8-12S	J-85
C5455X8X8	2025-8-8S	J-85
C5305X10	2027-10-10S	J-94
C5305X10X8	2027-10-8S	J-94
C5305X12X10	2027-12-10S	J-94
C5305X12	2027-12-12S	J-94
C5305X12X8	2027-12-8S	J-94
C5305X14	2027-14-14S	J-94
C5305X16X12	2027-16-12S	J-94
C5305X16	2027-16-16S	J-94
C5305X2	2027-2-2S	J-94
C5305X20	2027-20-20S	J-94
C5305X24	2027-24-24S	J-94
C5305X3	2027-3-3S	J-94
C5305X32	2027-32-32S	J-94
C5305X4	2027-4-4S	J-94
C5305X5X4	2027-5-4S	J-94
C5305X5	2027-5-5S	J-94
C5305X6X4	2027-6-4S	J-94
C5305X6X5	2027-6-5S	J-94
C5305X6	2027-6-6S	J-94
C5305X8X4	2027-8-4S	J-94
C5305X8X6	2027-8-6S	J-94
C5305X8	2027-8-8S	J-94
C5315X10	202702-10-10S	J-104
C5315X12X10	202702-10-12S	J-104
C5315X16X10	202702-10-16S	J-104
C5315X4X10	202702-10-4S	J-104
C5315X6X10	202702-10-6S	J-104
C5315X8X10	202702-10-8S	J-104
C5315X10X12	202702-12-10S	J-104
C5315X12	202702-12-12S	J-104
C5315X16X12	202702-12-16S	J-104
C5315X8X12	202702-12-8S	J-104
C5315X12X14	202702-14-12S	J-104
C5315X14	202702-14-14S	J-104
C5315X10X16	202702-16-10S	J-104
C5315X12X16	202702-16-12S	J-104
C5315X16	202702-16-16S	J-104
C5315X20X16	202702-16-20S	J-104
C5315X8X16	202702-16-8S	J-104
C5315X2	202702-2-2S	J-104
C5315X12X20	202702-20-12S	J-104
C5315X16X20	202702-20-16S	J-104
C5315X20	202702-20-20S	J-104

Part number catalog cross referencing index

Former WH Part Number	Eaton Part Number	Catalog Page
C5315X24X20	202702-20-24S	J-104
C5315X16X24	202702-24-16S	J-104
C5315X20X24	202702-24-20S	J-104
C5315X24	202702-24-24S	J-104
C5315X32X24	202702-24-32S	J-104
C5315X3	202702-3-3S	J-104
C5315X32	202702-32-32S	J-104
C5315X4	202702-4-4S	J-104
C5315X5X4	202702-4-5S	J-104
C5315X6X4	202702-4-6S	J-104
C5315X4X5	202702-5-4S	J-104
C5315X5	202702-5-5S	J-104
C5315X6X5	202702-5-6S	J-104
C5315X4X6	202702-6-4S	J-104
C5315X5X6	202702-6-5S	J-104
C5315X6	202702-6-6S	J-104
C5315X8X6	202702-6-8S	J-104
C5315X10X8	202702-8-10S	J-104
C5315X12X8	202702-8-12S	J-104
C5315X4X8	202702-8-4S	J-104
C5315X6X8	202702-8-6S	J-104
C5315X8	202702-8-8S	J-104
C5306X10	202712-10-10S	J-95
C5306X12	202712-12-12S	J-95
C5306X16	202712-16-16S	J-95
C5306X20	202712-20-20S	J-95
C5306X4	202712-4-4S	J-95
C5306X6	202712-6-6S	J-95
C5306X8	202712-8-8S	J-95
C5316X10	202713-10-10S	J-105
C5316X12	202713-12-12S	J-105
C5316X16	202713-16-16S	J-105
C5316X4	202713-4-4S	J-105
C5316X6	202713-6-6S	J-105
C5316X8X6	202713-6-8S	J-105
C5316X8	202713-8-8S	J-105
C5755X10X12X10	2028-12-10S	J-86
C5755X12	2028-12-12S	J-86
C5755X16	2028-16-16S	J-86
C5755X4	2028-2-4S	J-86
C5755X20	2028-20-20S	J-86
C5755X4X4X4	2028-4-4S	J-86
C5755X5X4X5	2028-4-5S	J-86
C5755X6	2028-4-6S	J-86
C5755X6X6X6	2028-6-6S	J-86
C5755X8	2028-6-8S	J-86
C5755X10	2028-8-10S	J-86
C5755X8X8X8	2028-8-8S	J-86
C5805X12	2029-12-12S	J-88
C5805X16	2029-16-16S	J-88
C5805X4	2029-2-4S	J-88
C5805X6	2029-4-6S	J-88
C5605X12	2030-12-12S	J-87
C5605X16	2030-16-16S	J-87
C5605X4	2030-2-4S	J-87
C5605X5	2030-2-5S	J-87
C5605X4X4X4	2030-4-4S	J-87
C5605X6	2030-4-6S	J-87
C5605X6X6X6	2030-6-6S	J-87
C5605X8	2030-6-8S	J-87
C5605X10	2030-8-10S	J-87
C5605X8X8X8	2030-8-8S	J-87
C5725X10	203002-1-10-10S	J-100
C5725X12	203002-1-12-12S	J-100
C5725X16	203002-1-16-16S	J-100
C5725X4	203002-1-4-4S	J-100
C5725X6	203002-1-6-6S	J-100

Former WH Part Number	Eaton Part Number	Catalog Page
C5725X8	203002-1-8-8S	J-100
C5715X10	203003-10-10S	J-108
C5715X12	203003-12-12S	J-108
C5715X16	203003-16-16S	J-108
C5715X20	203003-20-20S	J-108
C5715X4	203003-4-4S	J-108
C5715X6	203003-6-6S	J-108
C5715X8	203003-8-8S	J-108
C5716X10	203005-10-10S	J-108
C5716X12	203005-12-12S	J-108
C5716X16	203005-16-16S	J-108
C5716X20	203005-20-20S	J-108
C5716X4	203005-4-4S	J-108
C5716X5	203005-5-5S	J-108
C5716X6	203005-6-6S	J-108
C5716X8	203005-8-8S	J-108
C5655X12	2031-12-12S	J-88
C5655X16	2031-16-16S	J-88
C5655X4	2031-2-4S	J-88
C5655X32	2031-32-32S	J-88
C5655X4X4X4	2031-4-4S	J-88
C5655X6	2031-4-6S	J-88
C5655X8	2031-6-8S	J-88
C5655X10	2031-8-10S	J-88
C5655X8X8X8	2031-8-8S	J-88
C5707X10	203101-10-10S	J-101
C5707X12	203101-12-12S	J-101
C5707X16	203101-16-16S	J-101
C5707X20	203101-20-20S	J-101
C5707X4	203101-4-4S	J-101
C5707X6	203101-6-6S	J-101
C5707X8	203101-8-8S	J-101
C5706X10	203102-10-10S	J-101
C5706X12	203102-12-12S	J-101
C5706X16	203102-16-16S	J-101
C5706X20	203102-20-20S	J-101
C5706X4	203102-4-4S	J-101
C5706X5	203102-5-5S	J-101
C5706X6	203102-6-6S	J-101
C5706X8	203102-8-8S	J-101
C5705X10	2033-10-10S	J-100
C5705X12	2033-12-12S	J-100
C5705X16	2033-16-16S	J-100
C5705X20	2033-20-20S	J-100
C5705X24	2033-24-24S	J-100
C5705X4	2033-4-4S	J-100
C5705X5	2033-5-5S	J-100
C5705X6	2033-6-6S	J-100
C5705X8	2033-8-8S	J-100
C5505X10	2039-10-10S	J-98
C5505X12	2039-12-12S	J-98
C5505X16	2039-16-16S	J-98
C5505X20	2039-20-20S	J-98
C5505X24	2039-24-24S	J-98
C5505X4	2039-4-4S	J-98
C5505X5	2039-5-5S	J-98
C5505X6	2039-6-6S	J-98
C5505X8	2039-8-8S	J-98
C3209X16X12	2040-12-16S	J-65
C3209X20X16	2040-16-20S	J-65
C3209X4X2	2040-2-4S	J-65
C3209X8X2	2040-2-8S	J-65
C3209X24X20	2040-20-24S	J-65
C3209X32X24	2040-24-32s	J-65
C3209X12X4	2040-4-12S	J-65
C3209X6X4	2040-4-6S	J-65
C3209X8X4	2040-4-8S	J-65

Part number catalog cross referencing index

Former WH Part Number	Eaton Part Number	Catalog Page
C3209X8X6	2040-6-8S	J-65
C3209X12X8	2040-8-12S	J-65
C3209X16X8	2040-8-16S	J-65
C5325X10	2041-1-10-10S	J-95
C5325X12	2041-1-12-12S	J-95
C5325X16	2041-1-16-16S	J-95
C5325X20	2041-1-20-20S	J-95
C5325X3	2041-1-3-3S	J-95
C5325X4	2041-1-4-4S	J-95
C5325X5	2041-1-5-5S	J-95
C5325X6	2041-1-6-6S	J-95
C5325X8	2041-1-8-8S	J-95
C5325X12BN	2041-12-12S	J-95
C5325X20BN	2041-20-20S	J-95
C5325X3BN	2041-3-3S	J-95
C5325X4BN	2041-4-4S	J-95
C5325X5BN	2041-5-5S	J-95
C5325X6BN	2041-6-6S	J-95
C5325X8BN	2041-8-8S	J-95
C5375X10	2042-1-10-10S	J-97
C5375X12	2042-1-12-12S	J-97
C5375X4	2042-1-4-4S	J-97
C5375X5	2042-1-5-5S	J-97
C5375X6	2042-1-6-6S	J-97
C5375X8	2042-1-8-8S	J-97
C5525X10	2043-1-10-10S	J-98
C5525X12	2043-1-12-12S	J-98
C5525X16	2043-1-16-16S	J-98
C5525X4	2043-1-4-4S	J-98
C5525X5	2043-1-5-5S	J-98
C5525X6	2043-1-6-6S	J-98
C5525X8	2043-1-8-8S	J-98
9205X12X12	2045-12-12S	J-66
9205X12X16	2045-12-16S	J-66
9205X12X8	2045-12-8S	J-66
9205X16X12	2045-16-12S	J-66
9205X16X16	2045-16-16S	J-66
9205X16X20	2045-16-20S	J-66
9205X2X2	2045-2-2S	J-66
9205X2X4	2045-2-4S	J-66
9205X20X16	2045-20-16S	J-66
9205X20X20	2045-20-20S	J-66
9205X20X24	2045-20-24S	J-66
9205x24x20	2045-24-20S	J-66
9205X24X24	2045-24-24S	J-66
9205X32X32	2045-32-32S	J-66
9205X4X2	2045-4-2S	J-66
9205X4X4	2045-4-4S	J-66
9205X4X6	2045-4-6S	J-66
9205X4X8	2045-4-8S	J-66
9205X6X4	2045-6-4S	J-66
9205X6X6	2045-6-6S	J-66
9205X6X8	2045-6-8S	J-66
9205X8X12	2045-8-12S	J-66
9205X8X6	2045-8-6S	J-66
9205X8X8	2045-8-8S	J-66
9255X12X12	2046-12-12S	J-66
9255X12X16	2046-12-16S	J-66
9255X16X16	2046-16-16S	J-66
9255X2X2	2046-2-2S	J-66
9255X2X4	2046-2-4S	J-66
9255X20X20	2046-20-20S	J-66
9255X24X24	2046-24-24S	J-66
9255X32X32	2046-32-32S	J-66
9255X4X4	2046-4-4S	J-66
9255X4X6	2046-4-6S	J-66
9255X6X4	2046-6-4S	J-66

Former WH Part Number	Eaton Part Number	Catalog Page
9255X6X6	2046-6-6S	J-66
9255X6X8	2046-6-8S	J-66
9255X8X6	2046-8-6S	J-66
9255X8X8	2046-8-8S	J-66
9405X12X12	2047-12-12S	J-72
9405X12X16	2047-12-16S	J-72
9405X12X8	2047-12-8S	J-72
9405X16X12	2047-16-12S	J-72
9405X16X16	2047-16-16S	J-72
9405X2X2	2047-2-2S	J-72
9405X2X4	2047-2-4S	J-72
9405X20X20	2047-20-20S	J-72
9405X24X24	2047-24-24S	J-72
9405X32X32	2047-32-32S	J-72
9405X4X2	2047-4-2S	J-72
9405X4X4	2047-4-4S	J-72
9405X4X6	2047-4-6S	J-72
9405X4X8	2047-4-8S	J-72
9405X6X12	2047-6-12S	J-72
9405X6X4	2047-6-4S	J-72
9405X6X6	2047-6-6S	J-72
9405X6X8	2047-6-8S	J-72
9405X8X12	2047-8-12S	J-72
9405X8X6	2047-8-6S	J-72
9405X8X8	2047-8-8S	J-72
9455X12X12	2048-12-12S	J-71
9455X12X8	2048-12-8S	J-71
9455X16X16	2048-16-16S	J-71
9455X2X2	2048-2-2S	J-71
9455X20X20	2048-20-20S	J-71
9455X24X24	2048-24-24S	J-71
9455X4X4	2048-4-4S	J-71
9455X4X6	2048-4-6S	J-71
9455X4X8	2048-4-8S	J-71
9455X6X4	2048-6-4S	J-71
9455X6X6	2048-6-6S	J-71
9455X6X8	2048-6-8S	J-71
9455X8X12	2048-8-12S	J-71
9455X8X6	2048-8-6S	J-71
9455X8X8	2048-8-8S	J-71
9355X12X12	2049-12-12S	J-68
9355X12X16	2049-12-16S	J-68
9355X12X8	2049-12-8S	J-68
9355X16X12	2049-16-12S	J-68
9355X16X16	2049-16-16S	J-68
9355X16X20	2049-16-20S	J-68
9355X2X2	2049-2-2S	J-68
9355X20X20	2049-20-20S	J-68
9355X24X24	2049-24-24S	J-68
9355X4X2	2049-4-2S	J-68
9355X4X4	2049-4-4S	J-68
9355X4X6	2049-4-6S	J-68
9355X4X8	2049-4-8S	J-68
9355X6X4	2049-6-4S	J-68
9355X6X6	2049-6-6S	J-68
9355X6X8	2049-6-8S	J-68
9355X8X12	2049-8-12S	J-68
9355X8X6	2049-8-6S	J-68
9355X8X8	2049-8-8S	J-68
9385X12X12	2050-12-12S	J-67
9385X12X16	2050-12-16S	J-67
9385X16X16	2050-16-16S	J-67
9385X2X2	2050-2-2S	J-67
9385X20X20	2050-20-20S	J-67
9385X4X4	2050-4-4S	J-67
9385X4X6	2050-4-6S	J-67
9385X6X6	2050-6-6S	J-67

Part number catalog cross referencing index

Former WH Part Number	Eaton Part Number	Catalog Page
9385X6X8	2050-6-8S	J-67
9385X8X8	2050-8-8S	J-67
C5365X10	2061-10-10S	J-106
C5365X12X10	2061-10-12S	J-106
C5365X8X10	2061-10-8S	J-106
C5365X10X12	2061-12-10S	J-106
C5365X12	2061-12-12S	J-106
C5365X16X12	2061-12-16S	J-106
C5365X8X12	2061-12-8S	J-106
C5365X14	2061-14-14S	J-106
C5365X12X16	2061-16-12S	J-106
C5365X16	2061-16-16S	J-106
C5365X20X16	2061-16-20S	J-106
C5365X16X20	2061-20-16S	J-106
C5365X20	2061-20-20S	J-106
C5365X4	2061-4-4S	J-106
C5365X5	2061-5-5S	J-106
C5365X4X6	2061-6-4S	J-106
C5365X6	2061-6-6S	J-106
C5365X8X6	2061-6-8S	J-106
C5365X10X8	2061-8-10S	J-106
C5365X6X8	2061-8-6S	J-106
C5365X8	2061-8-8S	J-106
C5515X10	2062-10-10S	J-107
C5515X12X10	2062-10-12S	J-107
C5515X6X10	2062-10-6S	J-107
C5515X8X10	2062-10-8S	J-107
C5515X10X12	2062-12-10S	J-107
C5515X12	2062-12-12S	J-107
C5515X16X12	2062-12-16S	J-107
C5515X20X12	2062-12-20S	J-107
C5515X8X12	2062-12-8S	J-107
C5515X16X14	2062-14-16S	J-107
C5515X10X16	2062-16-10S	J-107
C5515X12X16	2062-16-12S	J-107
C5515X16	2062-16-16S	J-107
C5515X20X16	2062-16-20S	J-107
C5515X8X16	2062-16-8S	J-107
C5515X16X20	2062-20-16S	J-107
C5515X20	2062-20-20S	J-107
C5515X24X20	2062-20-24S	J-107
C5515X20X24	2062-24-20S	J-107
C5515X24	2062-24-24S	J-107
C5515X4	2062-4-4S	J-107
C5515X5X4	2062-4-5S	J-107
C5515X6X4	2062-4-6S	J-107
C5515X4X5	2062-5-4S	J-107
C5515X5	2062-5-5S	J-107
C5515X6X5	2062-5-6S	J-107
C5515X4X6	2062-6-4S	J-107
C5515X5X6	2062-6-5S	J-107
C5515X6	2062-6-6S	J-107
C5515X8X6	2062-6-8S	J-107
C5515X10X8	2062-8-10S	J-107
C5515X12X8	2062-8-12S	J-107
C5515X6X8	2062-8-6S	J-107
C5515X8	2062-8-8S	J-107
C5515X10LL	206209-10-10S	J-106
C5515X12LL	206209-12-12S	J-106
C5515X16LL	206209-16-16S	J-106
C5515X6LL	206209-6-6S	J-106
C5515X10X8LL	206209-8-10S	J-106
C5515X8LL	206209-8-8S	J-106
9315X10X12	2066-12-10S	J-91
9315X12X12	2066-12-12S	J-91
9315X14X12	2066-12-14S	J-91
9315X16X12	2066-12-16S	J-91

Former WH Part Number	Eaton Part Number	Catalog Page
9315X8X12	2066-12-8S	J-91
9315X16X16	2066-16-16S	J-91
9315X20X16	2066-16-20S	J-91
9315X20X20	2066-20-20S	J-91
9315x24x24	2066-24-24S	J-91
9315X4X4	2066-4-4S	J-91
9315X5X4	2066-4-5S	J-91
9315X6X4	2066-4-6S	J-91
9315X8X4	2066-4-8S	J-91
9315X10X6	2066-6-10S	J-91
9315X4X6	2066-6-4S	J-91
9315X6X6	2066-6-6S	J-91
9315X8X6	2066-6-8S	J-91
9315X10X8	2066-8-10S	J-91
9315X12X8	2066-8-12S	J-91
9315X6X8	2066-8-6S	J-91
9315X8X8	2066-8-8S	J-91
9365X12X12	2067-12-12S	J-92
9365X16X12	2067-12-16S	J-92
9365X8X12	2067-12-8S	J-92
9365X16X16	2067-16-16S	J-92
9365X20X20	2067-20-20S	J-92
9365X4X4	2067-4-4S	J-92
9365X4X6	2067-6-4S	J-92
9365X6X6	2067-6-6S	J-92
9365X8X6	2067-6-8S	J-92
9365X10X8	2067-8-10S	J-92
9365X6X8	2067-8-6S	J-92
9365X8X8	2067-8-8S	J-92
9515X10X12	2068-12-10S	J-93
9515X12X12	2068-12-12S	J-93
9515X16X12	2068-12-16S	J-93
9515X8X12	2068-12-8S	J-93
9515X16X16	2068-16-16S	J-93
9515X16X20	2068-20-16S	J-93
9515X20X20	2068-20-20S	J-93
9515X4X4	2068-4-4S	J-93
9515X6X4	2068-4-6S	J-93
9515X10X6	2068-6-10S	J-93
9515X4X6	2068-6-4S	J-93
9515X6X6	2068-6-6S	J-93
9515X8X6	2068-6-8S	J-93
9515X10X8	2068-8-10S	J-93
9515X12X8	2068-8-12S	J-93
9515X6X8	2068-8-6S	J-93
9515X8X8	2068-8-8S	J-93
C3459X12	206801-12-12S	J-93
C3459X16	206801-16-16S	J-93
C3459X20	206801-20-20S	J-93
C3459X6	206801-4-6S	J-93
C3459X8	206801-6-8S	J-93
C3459X10	206801-8-10S	J-93
C3459X8X8	206801-8-8S	J-93
C3469x12	206804-12-12S	J-93
C3469X16	206804-16-16S	J-93
C3469X8	206804-6-8S	J-93
C3469X10	206804-8-10S	J-93
C5356X10	2070-10-10S	J-97
C5356X12	2070-12-12S	J-97
C5356X14	2070-14-14S	J-97
C5356X16	2070-16-16S	J-97
C5356X20	2070-20-20S	J-97
C5356X4	2070-4-4S	J-97
C5356X5	2070-5-5S	J-97
C5356X6	2070-6-6S	J-97
C5356X8	2070-8-8S	J-97
C5506X10	2071-10-10S	J-98

Part number catalog cross referencing index

Former WH Part Number	Eaton Part Number	Catalog Page
C5506X8X10	2071-10-8S	J-98
C5506X12	2071-12-12S	J-98
C5506X14	2071-14-14S	J-98
C5506X16	2071-16-16S	J-98
C5506X20	2071-20-20S	J-98
C5506X24	2071-24-24S	J-98
C5506X32	2071-32-32S	J-98
C5506X4	2071-4-4S	J-98
C5506X6X4	2071-4-6S	J-98
C5506X5	2071-5-5S	J-98
C5506X4X6	2071-6-4S	J-98
C5506X6	2071-6-6S	J-98
C5506X10X8	2071-8-10S	J-98
C5506X6X8	2071-8-6S	J-98
C5506X8	2071-8-8S	J-98
C3959X12	2080-12-12S	J-76
C3959X16	2080-16-16S	J-76
C3959X2	2080-2-2S	J-76
C3959X4	2080-4-4S	J-76
C3959X6	2080-6-6S	J-76
C3959X8	2080-8-8S	J-76
C3109X12X4	2081-12-4S	J-63
C3109X12X6	2081-12-6S	J-63
C3109X12X8	2081-12-8S	J-63
C3109X16X12	2081-16-12S	J-63
C3109X16X4	2081-16-4S	J-63
C3109X16X6	2081-16-6S	J-63
C3109X16X8	2081-16-8S	J-63
C3109X20X12	2081-20-12S	J-63
C3109X20X16	2081-20-16S	J-63
C3109X20X8	2081-20-8S	J-63
C3109X24X12	2081-24-12S	J-63
C3109X24X16	2081-24-16S	J-63
C3109X24X20	2081-24-20S	J-63
C3109X32X16	2081-32-16S	J-63
C3109X32X20	2081-32-20S	J-63
C3109X32X24	2081-32-24S	J-63
C3109X4X2	2081-4-2S	J-63
C3109X6X2	2081-6-2S	J-63
C3109X6X4	2081-6-4S	J-63
C3109X8X2	2081-8-2S	J-63
C3109X8X4	2081-8-4S	J-63
C3109X8X6	2081-8-6S	J-63
C3159X12	2082-12S	J-64
C3159X16	2082-16S	J-64
C3159X20	2082-20S	J-64
C3159X24	2082-24S	J-64
C3159X2	2082-2S	J-64
C3159X32	2082-32S	J-64
C3159X4	2082-4S	J-64
C3159X6	2082-6S	J-64
C3159X8	2082-8S	J-64
C3069X1	2083-1-1S	J-61
C3069X12	2083-12-12S	J-61
C3069X12X6	2083-12-6S	J-61
C3069X12X8	2083-12-8S	J-61
C3069X16X12	2083-16-12S	J-61
C3069X16	2083-16-16S	J-61
C3069X2X1	2083-2-1S	J-61
C3069X2	2083-2-2S	J-61
C3069X20X16	2083-20-16S	J-61
C3069X20	2083-20-20S	J-61
C3069X24	2083-24-24S	J-61
C3069X32	2083-32-32S	J-61
C3069X4X2	2083-4-2S	J-16
C3069X4	2083-4-4S	J-16
C3069X6X2	2083-6-2S	J-16

Former WH Part Number	Eaton Part Number	Catalog Page
C3069X6X4	2083-6-4S	J-16
C3069X6	2083-6-6S	J-61
C3069X8X4	2083-8-4S	J-61
C3069X8X6	2083-8-6S	J-61
C3069X8	2083-8-8S	J-61
C3529X12	2085-12-12S	J-69
C3529X12X8	2085-12-8S	J-69
C3529X16X12	2085-16-12S	J-69
C3529X16	2085-16-16S	J-69
C3529X2	2085-2-2S	J-69
C3529X4	2085-4-4S	J-69
C3529X6X4	2085-6-4S	J-69
C3529X6	2085-6-6S	J-69
C3529X8X6	2085-8-6S	J-69
C3529X8	2085-8-8S	J-69
C3559X12	2086-12-12S	J-69
C3559X16	2086-16-16S	J-69
C3559X4	2086-4-4S	J-69
C3559X6	2086-6-6S	J-69
C3559X8	2086-8-8S	J-69
C3509X12	2087-12-12S	J-73
C3509X12X8	2087-12-8S	J-73
C3509X16X12	2087-16-12S	J-73
C3509X16	2087-16-16S	J-73
C3509X2	2087-2-2S	J-73
C3509X20	2087-20-20S	J-73
C3509X24	2087-24-24S	J-73
C3509X4X2	2087-4-2S	J-73
C3509X4	2087-4-4S	J-73
C3509X6X4	2087-6-4S	J-73
C3509X6	2087-6-6S	J-73
C3509X8X6	2087-8-6S	J-73
C3509X8	2087-8-8S	J-73
C3359X12	2088-12-12S	J-68
C3359X16	2088-16-16S	J-68
C3359X2	2088-2-2S	J-68
C3359X4	2088-4-4S	J-68
C3359X6	2088-6-6S	J-68
C3359X8	2088-8-8S	J-68
C3409X12	2089-12-12S	J-70
C3409X12X8	2089-12-8S	J-70
C3409X16	2089-16-16S	J-70
C3409X2	2089-2-2S	J-70
C3409X2X4	2089-2-4S	J-70
C3409X20	2089-20-20S	J-70
C3409X24	2089-24-24S	J-70
C3409X32	2089-32-32S	J-70
C3409X4X2	2089-4-2S	J-70
C3409X4	2089-4-4S	J-70
C3409X4X6	2089-4-6S	J-70
C3409X6X4	2089-6-4S	J-70
C3409X6	2089-6-6S	J-70
C3409X6X8	2089-6-8S	J-70
C3409X8X12	2089-8-12S	J-70
C3409X8X6	2089-8-6S	J-70
C3409X8	2089-8-8S	J-70
C3709X12	2090-12-12S	J-76
C3709X16	2090-16-16S	J-76
C3709X2	2090-2-2S	J-76
C3709X20	2090-20-20S	J-76
C3709X24	2090-24-24S	J-76
C3709X4	2090-4-4S	J-76
C3709X6	2090-6-6S	J-76
C3709X8	2090-8-8S	J-76
C3609X12	2091-12-12S	J-76
C3609X16	2091-16-16S	J-76
C3609X2	2091-2-2S	J-76

Part number catalog cross referencing index

Former WH Part Number	Eaton Part Number	Catalog Page
C3609X4	2091-4-4S	J-76
C3609X6	2091-6-6S	J-76
C3609X8	2091-8-8S	J-76
C3759X12	2092-12-12S	J-74
C3759X16	2092-16-16S	J-74
C3759X2	2092-2-2S	J-74
C3759X20	2092-20-20S	J-74
C3759X4	2092-4-4S	J-74
C3759X6	2092-6-6S	J-74
C3759X8	2092-8-8S	J-74
C3805X12	2093-12-12S	J-74
C3805X16	2093-16-16S	J-74
C3805X2	2093-2-2S	J-74
C3805X4	2093-4-4S	J-74
C3805X6	2093-6-6S	J-74
C3805X8	2093-8-8S	J-74
C3309X12X8	2096-12-8S	J-67
C3309X12	2096-12S	J-67
C3309X16X12	2096-16-12S	J-67
C3309X16	2096-16S	J-67
C3309X20	2096-20S	J-67
C3309X24	2096-24S	J-67
C3309X2	2096-2S	J-67
C3309X32	2096-32S	J-67
C3309X4X2	2096-4-2S	J-67
C3309X4	2096-4S	J-67
C3309X6X4	2096-6-4S	J-67
C3309X6	2096-6S	J-67
C3309X8X4	2096-8-4S	J-67
C3309X8X6	2096-8-6S	J-67
C3309X8	2096-8S	J-67
C5924X10	210212-10S	J-102
C5924X12	210212-12S	J-102
C5924X16	210212-16S	J-102
C5924X20	210212-20S	J-102
C5924X24	210212-24S	J-102
C5924X3	210212-3S	J-102
C5924X4	210212-4S	J-102
C5924X5	210212-5S	J-102
C5924X6	210212-6S	J-102
C5924X8	210212-8S	J-102
C5129X10	210292-10S	J-96
C5129X12	210292-12S	J-96
C5129X16	210292-16S	J-96
C5129X20	210292-20S	J-96
C5129X24	210292-24S	J-96
C5129X2	210292-2S	J-96
C5129X32	210292-32S	J-96
C5129X3	210292-3S	J-96
C5129X4	210292-4S	J-96
C5129X5	210292-5S	J-96
C5129X6	210292-6S	J-96
C5129X8	210292-8S	J-96
C5115X10	221000-10S	J-126
C5115X12	221000-12S	J-126
C5115X14	221000-14S	J-126
C5115X16	221000-16S	J-126
C5115X4	221000-4S	J-126
C5115X5	221000-5S	J-126
C5115X6	221000-6S	J-126
C5115X8	221000-8S	J-126
C5015X10X4	2215-10-4S	J-96
C5015X10X6	2215-10-6S	J-96
C5015X10X8	2215-10-8S	J-96
C5015X12X10	2215-12-10S	J-96
C5015X14X8	2215-14-8S	J-96
C5015X16X10	2215-16-10S	J-96

Former WH Part Number	Eaton Part Number	Catalog Page
C5015X16X8	2215-16-8S	J-96
C5015X20X16	2215-20-16S	J-96
C5015x24x16	2215-24-16S	J-96
C5015X24X20	2215-24-20S	J-96
C5015X24X32	2215-24-32S	J-96
C5015X32X24	2215-32-24S	J-96
C5015x6x5	2215-6-5S	J-96
C5015X16X6	221501-16-6S	J-97
C3269X10X12	2216-12-10S	J-92
C3269X12X12	2216-12-12S	J-92
C3269X14X12	2216-12-14S	J-92
C3269X16X12	2216-12-16S	J-92
C3269X16X16	2216-16-16S	J-92
C3269X20X16	2216-16-20S	J-92
C3269X4X2	2216-2-4S	J-92
C3269X5X2	2216-2-5S	J-92
C3269X20X20	2216-20-20S	J-92
C3269X24X24	2216-24-24S	J-92
C3269X32X32	2216-32-32S	J-92
C3269X10X4	2216-4-10S	J-92
C3269X4X4	2216-4-4S	J-92
C3269X5X4	2216-4-5S	J-92
C3269X6X4	2216-4-6S	J-92
C3269X8X4	2216-4-8S	J-92
C3269X10X6	2216-6-10S	J-92
C3269X12X6	2216-6-12S	J-92
C3269X6X6	2216-6-6S	J-92
C3269X8X6	2216-6-8S	J-92
C3269X10X8	2216-8-10S	J-92
C3269X12X8	2216-8-12S	J-92
C3269X16X8	2216-8-16S	J-92
C3269X6X8	2216-8-6S	J-92
C3269X8X8	2216-8-8S	J-92
C5314X10X10	2220-10-10S	J-59
C5314X12X12	2220-12-12S	J-59
C5314X16X16	2220-16-16S	J-59
C5314X20X20	2220-20-20S	J-59
C5314X24X24	2220-24-24S	J-59
C5314X4X4	2220-4-4S	J-59
C5314X6X6	2220-6-6S	J-59
C5314X8X8	2220-8-8S	J-59
C3169X1	2222-1S	J-65
C3169X2	2222-2S	J-65
C3169X4	2222-4S	J-65
C3169X6	2222-6S	J-65
C5275X12	2239-1-12-12S	J-79
C5275X16	2239-1-16-16S	J-79
C5275X4	2239-1-2-4S	J-79
C5275X6	2239-1-4-6S	J-79
C5275X8	2239-1-6-8S	J-79
C5275X10	2239-1-8-10S	J-79
C5256X12	2242-12-12S	J-79
C5256X14	2242-12-14S	J-79
C5256X16	2242-16-16S	J-79
C5256X4	2242-2-4S	J-79
C5256X5	2242-2-5S	J-79
C5256X20	2242-20-20S	J-79
C5256X4X4	2242-4-4S	J-79
C5256X5X4	2242-4-5S	J-79
C5256X6	2242-4-6S	J-79
C5256X6X6	2242-6-6S	J-79
C5256X8	2242-6-8S	J-79
C5256X10	2242-8-10S	J-79
C5256X6X8	2242-8-6S	J-79
C5256X8X8	2242-8-8S	J-79
C3239X12X12	2246-12-12S	J-91
C3239X14X12	2246-12-14S	J-91

Part number catalog cross referencing index

Former WH Part Number	Eaton Part Number	Catalog Page
C3239X16X16	2246-16-16S	J-91
C3239X4X2	2246-2-4S	J-91
C3239X5X2	2246-2-5S	J-91
C3239X6X4	2246-4-6S	J-91
C3239X6X6	2246-6-6S	J-91
C3239X8X6	2246-6-8S	J-91
C3239X10X8	2246-8-10S	J-91
C3239X6X8	2246-8-6S	J-91
C3239X8X8	2246-8-8S	J-91
C5406X12	2250-12-12S	J-84
C5406X14	2250-12-14S	J-84
C5406X8X12	2250-12-8S	J-84
C5406X16	2250-16-16S	J-84
C5406X4	2250-2-4S	J-84
C5406X5	2250-2-5S	J-84
C5406X20	2250-20-20S	J-84
C5406X24	2250-24-24S	J-84
C5406X32	2250-32-32S	J-84
C5406X4X4	2250-4-4S	J-84
C5406X6	2250-4-6S	J-84
C5406X8	2250-6-8S	J-84
C5406X10	2250-8-10S	J-84
9435X12X12	2251-12-12S	J-70
9435X4X4	2251-4-4S	J-70
9435X6X6	2251-6-6S	J-70
9435X8X8	2251-8-8S	J-70
9456X12X12X12	2253-12-12S	J-75
9456X6X6X6	2253-6-6S	J-75
9456X8X8X8	2253-8-8S	J-75
9406X12	2254-12-12S	J-75
9406X2X2X2	2254-2-2S	J-75
9406X4X4X4	2254-4-4S	J-75
9406X4X4X6	2254-4-6S	J-75
9406X4X4X8	2254-4-8S	J-75
9406X6X6X6	2254-6-6S	J-75
9406X6X6X8	2254-6-8S	J-75
9406X8X8X8	2254-8-8S	J-75
9705X12X12X12	2255-12-12S	J-75
9705X2X2X2	2255-2-2S	J-75
9705X4X4X4	2255-4-4S	J-75
9705X6X6X6	2255-6-6S	J-75
9705X8X8X8	2255-8-8S	J-75
7629X1	22617-1	J-112
7629X10	22617-10	J-112
7629X12	22617-12	J-112
7629X14	22617-14	J-112
7629X16	22617-16	J-112
7629X2	22617-2	J-112
7629X20	22617-20	J-112
7629X24	22617-24	J-112
7629X3	22617-3	J-112
7629X4	22617-4	J-112
7629X5	22617-5	J-112
7629X6	22617-6	J-112
7629X7	22617-7	J-112
7629X8	22617-8	J-112
C5216X10X10	2266-10-10S	J-105
C5216X12X12	2266-12-12S	J-105
C5216X16X12	2266-12-16S	J-105
C5216X16X16	2266-16-16S	J-105
C5216X20X20	2266-20-20S	J-105
C5216X24X24	2266-24-24S	J-105
C5216X4X4	2266-4-4S	J-105
C5216X4X6	2266-6-4S	J-105
C5216X6X6	2266-6-6S	J-105
C5216X8X6	2266-6-8S	J-105
C5216X6X8	2266-8-6S	J-105

Former WH Part Number	Eaton Part Number	Catalog Page
C5216X8X8	2266-8-8S	J-105
5117X10	259-1290-10	J-127
5117X12	259-1290-12	J-127
5117X16	259-1290-16	J-127
5117X20	259-1290-20	J-127
5117X24	259-1290-24	J-127
5117X32	259-1290-32	J-127
5117X4	259-1290-4	J-127
5117X6	259-1290-6	J-127
5117X8	259-1290-8	J-127
5217X10X12	259-2021-12-10	J-77
5217X12	259-2021-12-12	J-77
5217X16X12	259-2021-12-16	J-77
5217X8X12	259-2021-12-8	J-77
5217X16	259-2021-16-16	J-77
5217X4	259-2021-2-4	J-77
5217X16X20	259-2021-20-16	J-77
5217X20	259-2021-20-20	J-77
5217X24X20	259-2021-20-24	J-77
5217X24	259-2021-24-24	J-77
5217X32	259-2021-32-32	J-77
5217X4X4	259-2021-4-4	J-77
5217X5X4	259-2021-4-5	J-77
5217X6	259-2021-4-6	J-77
5217X8X4	259-2021-4-8	J-77
5217X10X6	259-2021-6-10	J-77
5217X4X6	259-2021-6-4	J-77
5217X6X6	259-2021-6-6	J-77
5217X8	259-2021-6-8	J-77
5217X10	259-2021-8-10	J-77
5217X12X8	259-2021-8-12	J-77
5217X6X8	259-2021-8-6	J-77
5217X8X8	259-2021-8-8	J-77
5267x16	259-2022-16-16	J-80
5267x4x4	259-2022-4-4	J-80
5267x6x6	259-2022-6-6	J-80
5267x8	259-2022-6-8	J-80
5267x8x8	259-2022-8-8	J-80
5367X6	259-2023-4-6	J-81
5417x16	259-2024-16-16	J-82
5417x4	259-2024-2-4	J-82
5417x4x4	259-2024-4-4	J-82
5417x6	259-2024-4-6	J-82
5417x8x8	259-2024-8-8	J-82
5317x12	259-2027-12-12	J-94
5317x16	259-2027-16-16	J-94
5317x4	259-2027-4-4	J-94
5317X6	259-2027-6-6	J-94
5317x8	259-2027-8-8	J-94
5327x12	259-202702-12-12	J-104
5327x16	259-202702-16-16	J-104
5327x8x16	259-202702-16-8	J-104
5327X4	259-202702-4-4	J-104
5327X6	259-202702-6-6	J-104
5327x6x8	259-202702-8-6	J-104
5327x8	259-202702-8-8	J-104
5337X8	259-2041-1-8-8	J-95
5518x4	259-2071-4-4	J-98
5518x6	259-2071-6-6	J-98
3121X12X4	259-2081-12-4	J-63
3121X16X12	259-2081-16-12	J-63
3121X16X8	259-2081-16-8	J-63
3121X20X12	259-2081-20-12	J-63
3121X20X16	259-2081-20-16	J-63
3121X32X16	259-2081-32-16	J-63
3121X32X20	259-2081-32-20	J-63
3121X4X2	259-2081-4-2	J-63

Part number catalog cross referencing index

Former WH Part Number	Eaton Part Number	Catalog Page
3121X6X2	259-2081-6-2	J-63
3121X6X4	259-2081-6-4	J-63
3121X8X4	259-2081-8-4	J-63
3121X8X6	259-2081-8-6	J-63
3171X16	259-2082-16	J-64
3171X2	259-2082-2	J-64
3171X4	259-2082-4	J-64
3171X6	259-2082-6	J-64
3081X12	259-2083-12-12	J-61
3081X16	259-2083-16-16	J-61
3081X2	259-2083-2-2	J-61
3081x20	259-2083-20-20	J-61
3081x24	259-2083-24-24	J-61
3081x4x2	259-2083-4-2	J-61
3081X4	259-2083-4-4	J-61
3081X6X4	259-2083-6-4	J-61
3081x6	259-2083-6-6	J-61
3081X8	259-2083-8-8	J-61
3521X4	259-2087-4-4	J-73
3421X6	259-2089-6-6	J-70
3321X12	259-2096-12	J-67
3321X20	259-2096-20	J-67
3321X4	259-2096-4	J-67
3321X4X2	259-2096-4-2	J-67
3321X6	259-2096-6	J-67
3321X8	259-2096-8	J-67
7936x12	259-210212-12	J-102
7936x6	259-210212-6	J-102
7936x8	259-210212-8	J-102
5141x4	259-210292-4	J-96
5141X8	259-210292-8	J-96
5241x12	259-900599-12	J-95
5241x6	259-900599-6	J-95
5177X10	259-900605-10	J-127
5177X12	259-900605-12	J-127
5177X16	259-900605-16	J-127
5177X20	259-900605-20	J-127
5177X24	259-900605-24	J-127
5177X4	259-900605-4	J-127
5177X6	259-900605-6	J-127
5177X8	259-900605-8	J-127
9205X4X4Z	307-2045-4-4	J-66
C3159X24Z	307-2082-24	J-64
C3159X8Z	307-2082-8	J-64
54508x12	500023-12-8S	J-117
54512	500023-12S	J-117
54520X16	500023-16-20S	J-117
54516	500023-16S	J-117
54516X20	500023-20-16S	J-117
54508	500023-8S	J-117
59008X12	500024-12-8S	J-118
59008	500024-8S	J-118
50008X12	500025-12-8S	J-116
50012	500025-12S	J-116
50016	500025-16S	J-116
50016X20	500025-20-16S	J-116
50020	500025-20S	J-116
50024	500025-24S	J-116
50008	500025-8S	J-116
B7237X10	900598-1-10S	J-58
B7237X12	900598-1-12S	J-58
B7237X14	900598-1-14S	J-58
B7237X16	900598-1-16S	J-58
B7237X20	900598-1-20S	J-58
B7237X24	900598-1-24S	J-58
B7237X2	900598-1-2S	J-58
B7237X32	900598-1-32S	J-58

Former WH Part Number	Eaton Part Number	Catalog Page
B7237X3	900598-1-3S	J-58
B7237X4	900598-1-4S	J-58
B7237X5	900598-1-5S	J-58
B7237X6	900598-1-6S	J-58
B7237X8	900598-1-8S	J-58
7237X10	900598-10S	J-58
7237X12	900598-12S	J-58
7237X14	900598-14S	J-58
7237X16	900598-16S	J-58
7237X20	900598-20S	J-58
7237X24	900598-24S	J-58
7237X2	900598-2S	J-58
7237X32	900598-32S	J-58
7237X3	900598-3S	J-58
7237X4	900598-4S	J-58
7237X5	900598-5S	J-58
7237X6	900598-6S	J-58
7237X8	900598-8S	J-58
C5229X10	900599-10S	J-95
C5229X12	900599-12S	J-95
C5229X14	900599-14S	J-95
C5229X16	900599-16S	J-95
C5229X20	900599-20S	J-95
C5229X24	900599-24S	J-95
C5229X32	900599-32S	J-95
C5229X3	900599-3S	J-95
C5229X4	900599-4S	J-95
C5229X5	900599-5S	J-95
C5229X6	900599-6S	J-95
C5229X8	900599-8S	J-95
C5165X10	900605-10S	J-127
C5165X12	900605-12S	J-127
C5165X14	900605-14S	J-127
C5165X16	900605-16S	J-127
C5165X20	900605-20S	J-127
C5165X24	900605-24S	J-127
C5165X2	900605-2S	J-127
C5165X32	900605-32S	J-127
C5165X3	900605-3S	J-127
C5165X4	900605-4S	J-127
C5165X5	900605-5S	J-127
C5165X6	900605-6S	J-127
C5165X8	900605-8S	J-127
4165X4	FC1229-0404S	J-41
4165X6	FC1229-0606S	J-41
4165X8	FC1229-0808S	J-41
4165X12	FC1229-1212S	J-41
4165X16	FC1229-1616S	J-41
4165X20	FC1229-2020S	J-41
4165X24	FC1229-2424S	J-41
4105X4	FC2326-04S	J-43
4105X6	FC2326-06S	J-43
4105X8	FC2326-08S	J-43
4105X10	FC2326-10S	J-43
4105X12	FC2326-12S	J-43
4105X16	FC2326-16S	J-43
4105X20	FC2326-20S	J-43
4105X24	FC2326-24S	J-43
7033X4X6	FF1010-0406S	J-58
7033X4X8	FF1010-0408S	J-58
7033X6X4	FF1010-0604S	J-58
7033X8X6	FF1010-0806S	J-58
7033X10X8	FF1010-1008S	J-58
7033X12X6	FF1010-1206S	J-58
7033X12X8	FF1010-1208S	J-58
7033X12X10	FF1010-1210S	J-58
7033X12X16	FF1010-1216S	J-58

Part number catalog cross referencing index

Former WH Part Number	Eaton Part Number	Catalog Page
7033X14X12	FF1010-1412S	J-58
7033X16X8	FF1010-1608S	J-58
7033X16X10	FF1010-1610S	J-58
7033X16X12	FF1010-1612S	J-58
7033X20X12	FF1010-2012S	J-58
7033X20X16	FF1010-2016S	J-58
7033X24X12	FF1010-2412S	J-58
7033X24X20	FF1010-2420S	J-58
C5015X6X4	FF1066-0604S	J-97
C5015X8X4	FF1066-0804S	J-97
C5015X8X6	FF1066-0806S	J-97
C5015X12X4	FF1066-1204S	J-97
C5015X12X6	FF1066-1206S	J-97
C5015X12X8	FF1066-1208S	J-97
C5015X16X12	FF1066-1612S	J-97
C5015X20X12	FF1066-2012S	J-97
C3249X4X2	FF1796-0402S	J-59
C3249X6X4	FF1796-0604S	J-59
C3249X8X6	FF1796-0806S	J-59
C3249X8X8	FF1796-0808S	J-59
C3249X10X8	FF1796-1008S	J-59
C3249X12X12	FF1796-1212S	J-59
C3249X16X16	FF1796-1616S	J-59
C3249X20X20	FF1796-2020S	J-59
C3249X24X24	FF1796-2424S	J-59
C3249X32X32	FF1796-3232S	J-59
4315X4X3	FF1852T0403S	J-44
4315X4	FF1852T0404S	J-44
4315X4X5	FF1852T0405S	J-44
4315X4X6	FF1852T0406S	J-44
4315X4X8	FF1852T0408S	J-44
4315X6X3	FF1852T0603S	J-44
4315X6X4	FF1852T0604S	J-44
4315X6X5	FF1852T0605S	J-44
4315X6	FF1852T0606S	J-44
4315X6X8	FF1852T0608S	J-44
4315X6X10	FF1852T0610S	J-44
4315X6X12	FF1852T0612S	J-44
4315X6X16	FF1852T0616S	J-44
4315X8X6	FF1852T0806S	J-44
4315X8	FF1852T0808S	J-44
4315X8X10	FF1852T0810S	J-44
4315X8X12	FF1852T0812S	J-44
4315X8X14	FF1852T0814S	J-44
4315X8X16	FF1852T0816S	J-44
4315X10X8	FF1852T1008S	J-44
4315X10	FF1852T1010S	J-44
4315X12X6	FF1852T1206S	J-44
4315X12X8	FF1852T1208S	J-44
4315X12X10	FF1852T1210S	J-44
4315X12	FF1852T1212S	J-44
4315X12X14	FF1852T1214S	J-44
4315X12X16	FF1852T1216S	J-44
4315X16X8	FF1852T1608S	J-44
4315X16X10	FF1852T1610S	J-44
4315X16X12	FF1852T1612S	J-44
4315X16X14	FF1852T1614S	J-44
4315X16	FF1852T1616S	J-44
4315X16X20	FF1852T1620S	J-44
4315X20X16	FF1852T2016S	J-44
4315X20	FF1852T2020S	J-44
4315X24X20	FF1852T2420S	J-44
4316X4	FF1854T0404S	J-45
4316X6	FF1854T0606S	J-45
4316X8	FF1854T0808S	J-45
4316X10	FF1854T1010S	J-45
4316X12	FF1854T1212S	J-45

Former WH Part Number	Eaton Part Number	Catalog Page
4316X16	FF1854T1616S	J-45
4316X20	FF1854T2020S	J-45
4316X24	FF1854T2424S	J-45
4707X4	FF1857T0404S	J-55
4707X6	FF1857T0606S	J-55
4707X8	FF1857T0808S	J-55
4707X10	FF1857T1010S	J-55
4707X12	FF1857T1212S	J-55
4707X16	FF1857T1616S	J-55
4707X20	FF1857T2020S	J-55
4715X4	FF1861T0404S	J-48
4715X6	FF1861T0606S	J-48
4715X8X6	FF1861T0806S	J-48
4715X8	FF1861T0808S	J-48
4715X10	FF1861T1010S	J-48
4715X12	FF1861T1212S	J-48
4715X12X16	FF1861T1216S	J-48
4715X16	FF1861T1616S	J-48
4716X4	FF1865T0404S	J-48
4716x4x6	FF1865T0406S	J-48
4716X6	FF1865T0606S	J-48
4716X8	FF1865T0808S	J-48
4716X12	FF1865T1212S	J-48
4515X4	FF1868T0404S	J-46
4515X4X5	FF1868T0405S	J-46
4515X4X6	FF1868T0406S	J-46
4515X4X8	FF1868T0408S	J-46
4515X6X4	FF1868T0604S	J-46
4515X6X5	FF1868T0605S	J-46
4515X6	FF1868T0606S	J-46
4515X6X8	FF1868T0608S	J-46
4515X6X10	FF1868T0610S	J-46
4515X6X12	FF1868T0612S	J-46
4515X8X6	FF1868T0806S	J-46
4515X8	FF1868T0808S	J-46
4515X8X10	FF1868T0810S	J-46
4515X8X12	FF1868T0812S	J-46
4515X10X8	FF1868T1008S	J-46
4515X10	FF1868T1010S	J-46
4515X10X12	FF1868T1012S	J-46
4515X12X8	FF1868T1208S	J-46
4515X12X10	FF1868T1210S	J-46
4515X12	FF1868T1212S	J-46
4515X12X14	FF1868T1214S	J-46
4515X12X16	FF1868T1216S	J-46
4515X16X12	FF1868T1612S	J-46
4515X16X14	FF1868T1614S	J-46
4515X16	FF1868T1616S	J-46
4515X16X20	FF1868T1620S	J-46
4515X20X12	FF1868T2012S	J-46
4515X20X16	FF1868T2016S	J-46
4515X20	FF1868T2020S	J-46
4515X24X20	FF1868T2420S	J-46
4515X24	FF1868T2424S	J-46
4705X4	FF1898T0404S	J-54
4705X6	FF1898T0606S	J-54
4705X6X6X8	FF1898T0608S	J-54
4705X8	FF1898T0808S	J-54
4705X10	FF1898T1010S	J-54
4705X12	FF1898T1212S	J-54
4325X6	FF1994H4-0606S	J-53
4325X8	FF1994H4-0808S	J-53
4325X10	FF1994H4-1010S	J-53
4325X12	FF1994H4-1212S	J-53
4325X16	FF1994H4-1616S	J-53
4305X4	FF2000T0404S	J-52
4305X6X4	FF2000T0604S	J-52

Part number catalog cross referencing index

Former WH Part Number	Eaton Part Number	Catalog Page
4305X6	FF2000T0606S	J-52
4305X8X6	FF2000T0806S	J-52
4305X8	FF2000T0808S	J-52
4305X10X8	FF2000T1008S	J-52
4305X10	FF2000T1010S	J-52
4305X12X8	FF2000T1208S	J-52
4305X12X10	FF2000T1210S	J-52
4305X12	FF2000T1212S	J-52
4305X16X12	FF2000T1612S	J-52
4305X16	FF2000T1616S	J-52
4305X20	FF2000T2020S	J-52
4305X24	FF2000T2424S	J-52
4525X6	FF2030H4-0606S	J-54
4525X8	FF2030H4-0808S	J-54
4525X12	FF2030H4-1212S	J-54
4525X16	FF2030H4-1616S	J-54
4205X4	FF2031T0402S	J-49
4205X4X6	FF2031T0406S	J-49
4205X4X8	FF2031T0408S	J-49
4205X6X2	FF2031T0602S	J-49
4205X6	FF2031T0604S	J-49
4205X6X6	FF2031T0606S	J-49
4205X6X8	FF2031T0608S	J-49
4205X8X4	FF2031T0804S	J-49
4205X8	FF2031T0806S	J-49
4205X8X8	FF2031T0808S	J-49
4205X8X12	FF2031T0812S	J-49
4205X10	FF2031T1008S	J-49
4205X10X12	FF2031T1012S	J-49
4205X12X8	FF2031T1208S	J-49
4205X12	FF2031T1212S	J-49
4205X12X16	FF2031T1216S	J-49
4205X16X12	FF2031T1612S	J-49
4205X16	FF2031T1616S	J-49
4205X16X20	FF2031T1620S	J-49
4205X20X16	FF2031T2016S	J-49
4205X20	FF2031T2020S	J-49
4205X24	FF2031T2424S	J-49
4405X4	FF2032T0402S	J-50
4405X6	FF2032T0604S	J-50
4405X8	FF2032T0806S	J-50
4405X10	FF2032T1008S	J-50
4405X12	FF2032T1212S	J-50
4405X16	FF2032T1616S	J-50
4405X20	FF2032T2020S	J-50
4405X24	FF2032T2424S	J-50
4505X4	FF2035T0404S	J-54
4505X4X6	FF2035T0604S	J-54
4505X6	FF2035T0606S	J-54
4505X8	FF2035T0808S	J-54
4505X10	FF2035T1010S	J-54
4505X12	FF2035T1212S	J-54
4505X16	FF2035T1616S	J-54
4505X20	FF2035T2020S	J-54
4365X4	FF2068T0404S	J-47
4365X4X6	FF2068T0406S	J-47
4365X4X8	FF2068T0408S	J-47
4365X6X4	FF2068T0604S	J-47
4365X6	FF2068T0606S	J-47
4365X6X8	FF2068T0608S	J-47
4365X8X6	FF2068T0806S	J-47
4365X8	FF2068T0808S	J-47
4365X8X10	FF2068T0810S	J-47
4365X8X16	FF2068T0816S	J-47
4365X10X8	FF2068T1008S	J-47
4365X10	FF2068T1010S	J-47
4365X10X12	FF2068T1012S	J-47

Former WH Part Number	Eaton Part Number	Catalog Page
4365X12X10	FF2068T1210S	J-47
4365X12	FF2068T1212S	J-47
4365X12X16	FF2068T1216S	J-47
4365X16X12	FF2068T1612S	J-47
4365X16	FF2068T1616S	J-47
4365X16X20	FF2068T1620S	J-47
4365X20	FF2068T2020S	J-47
4365X24	FF2068T2424S	J-47
4355X4	FF2093T0402S	J-49
4355X6	FF2093T0604S	J-49
4355X8	FF2093T0806S	J-49
4355X12	FF2093T1212S	J-49
4506X4	FF2098T0404S	J-53
4506X6	FF2098T0606S	J-53
4506X8	FF2098T0808S	J-53
4506X10	FF2098T1010S	J-53
4506X12	FF2098T1212S	J-53
4506X16	FF2098T1616S	J-53
4506X20	FF2098T2020S	J-53
4506X24	FF2098T2424S	J-53
4706X4	FF2114T0404S	J-55
4706X6	FF2114T0606S	J-55
4706X8	FF2114T0808S	J-55
4706X10	FF2114T1010S	J-55
4706X12	FF2114T1212S	J-55
4706X16	FF2114T1616S	J-55
4706X20	FF2114T2020S	J-55
4706X24	FF2114T2424S	J-55
B7238x2	FF2137-02S	J-59
B7238X3	FF2137-03S	J-59
B7238X4	FF2137-04S	J-59
B7238X5	FF2137-05S	J-59
B7238x6	FF2137-06S	J-59
B7238X8	FF2137-08S	J-59
B7238X10	FF2137-10S	J-59
B7238X12	FF2137-12S	J-59
B7238X14	FF2137-14S	J-59
B7238X16	FF2137-16S	J-59
B7238X20	FF2137-20S	J-59
7238X2	FF2138-02S	J-59
7238X3	FF2138-03S	J-59
7238X4	FF2138-04S	J-59
7238X5	FF2138-05S	J-59
7238X6	FF2138-06S	J-59
7238X8	FF2138-08S	J-59
7238X10	FF2138-10S	J-59
7238X12	FF2138-12S	J-59
7238X14	FF2138-14S	J-59
7238X16	FF2138-16S	J-59
7238X20	FF2138-20S	J-59
4375X4	FF2144H4-0404S	J-53
4375X6	FF2144H4-0606S	J-53
4375X8	FF2144H4-0808S	J-53
4726X4	FF2174T0404S	J-55
4726X6	FF2174T0606S	J-55
4726X8	FF2174T0808S	J-55
4726X12	FF2174T1212S	J-55
4726X16	FF2174T1616S	J-55
4726X20	FF2174T2020S	J-55
4213X4	FF2209T0404S	J-51
4213X12X4	FF2209T0412S	J-51
4213X6	FF2209T0606S	J-51
4213X12X6	FF2209T0612S	J-51
4213X8	FF2209T0808S	J-51
4213X12X8	FF2209T0812S	J-51
4213X10	FF2209T1010S	J-51
4213X12	FF2209T1212S	J-51

Part number catalog cross referencing index

Former WH Part Number	Eaton Part Number	Catalog Page
4213X16	FF2209T1616S	J-51
4213X16X20	FF2209T2016S	J-51
4213X20	FF2209T2020S	J-51
4515X4L	FF2227T0404S	J-47
4515X6L	FF2227T0606S	J-47
4515X8L	FF2227T0808S	J-47
4515X10L	FF2227T1010S	J-47
4515X12L	FF2227T1212S	J-47
4515X16L	FF2227T1616S	J-47
4515X20L	FF2227T2020S	J-47
C5515X6L	FF3910-0606S	J-106
C5515X8L	FF3910-0808S	J-106
C5515X12L	FF3910-1212S	J-106
9154X6X6	FF4174-0606S	J-103
9154X8X8	FF4174-0808S	J-103
9154X10X10	FF4174-1010S	J-103
9405X2X2LL	FF4175-0202S	J-72
9405X4X4LL	FF4175-0404S	J-72
9405X6X6LL	FF4175-0606S	J-72
9405X8X8LL	FF4175-0808S	J-72
9405X12X12LL	FF4175-1212S	J-72
9405X16X16LL	FF4175-1616S	J-72
C3179X2	FF4177-02S	J-64
C3179X4	FF4177-04S	J-64
C3179X6	FF4177-06S	J-64
C3179X8	FF4177-08S	J-64
C3179X12	FF4177-12S	J-64
C3179X16	FF4177-16S	J-64
M9600X4X4	FF4179-0404S	J-137
M9600X5X4	FF4179-0504S	J-137
M9600X6X4	FF4179-0604S	J-137
M9600X6X6	FF4179-0606S	J-137
M9600X8X6	FF4179-0806S	J-137
M9600X8X8	FF4179-0808S	J-137
M9600X10X8	FF4179-1008S	J-137
M9600X12X12	FF4179-1212S	J-137
M9600X16X16	FF4179-1616S	J-137
M9600X20X20	FF4179-2020S	J-137
M9700X4X6	FF4180-0406S	J-135
M9700X5X8	FF4180-0508S	J-135
M9700X6X10	FF4180-0610S	J-135
M9700X8X12	FF4180-0812S	J-135
M9700X10X14	FF4180-1014S	J-135
M9700X12X20	FF4180-1220S	J-135
M9700X16X25	FF4180-1625S	J-135
M9700X20X32	FF4180-2032S	J-135
M9800X4X4	FF4181-0404S	J-138
M9800X5X4	FF4181-0504S	J-138
M9800X6X4	FF4181-0604S	J-138
M9800X8X4	FF4181-0804S	J-138
M9800X8X6	FF4181-0806S	J-138
M9800X8X8	FF4181-0808S	J-138
M9800X10X8	FF4181-1008S	J-138
M9800X12X8	FF4181-1208S	J-138
M9800X12X12	FF4181-1212S	J-138
M9800X16X12	FF4181-1612S	J-138
M9800X16X16	FF4181-1616S	J-138
M9800X20X20	FF4181-2020S	J-138
W21204	FF4183-0404-1S	J-62
W05465	FF4183-0404-2S	J-62
W17709	FF4183-0606S	J-62
41157X4	FF4184-0404S	J-129
41157X6	FF4184-0606S	J-129
41157X8	FF4184-0808S	J-129
41157X10	FF4184-1010S	J-129
41157X12	FF4184-1212S	J-129
W05498	FF4185-0804-1S	J-62

Former WH Part Number	Eaton Part Number	Catalog Page
W05499	FF4185-0804-2S	J-62
W05730	FF4186-0804-1S	J-62
W23464	FF4186-0804-2S	J-62
M41157X6X14	FF4215-0614S	J-132
M41157X6X16	FF4215-0616S	J-132
M41157X6X18	FF4215-0618S	J-132
59012	FF5162-1212S	J-118
59016	FF5162-1616S	J-118
59020X16	FF5162-1620S	J-118
59016X20	FF5162-2016S	J-118
59020	FF5162-2020S	J-118
59024	FF5162-2424S	J-118
59032	FF5162-3232S	J-118
54520	FF5238-2020S	J-117
54524	FF5238-2424S	J-117
54532	FF5238-3232S	J-117
50032	FF5239-3232S	J-116
64512	FF5539-1212s	J-117
64512X16	FF5539-1612S	J-117
64516	FF5539-1616S	J-117
64516X20	FF5539-2016S	J-117
64520	FF5539-2020S	J-117
64516X24	FF5539-2416S	J-117
64520X24	FF5539-2420S	J-117
64524	FF5539-2424S	J-117
60012	FF5541-1212S	J-116
60016	FF5541-1616S	J-116
60020	FF5541-2020S	J-116
60024	FF5541-2424S	J-116
C5165X4X6MM	FF91488-0406S	J-135
C5165X5X8MM	FF91488-0508S	J-135
C5165X6X10MM	FF91488-0610S	J-135
C5165X8X12MM	FF91488-0812S	J-135
C5165X10X14MM	FF91488-1014S	J-135
C5165X10X15MM	FF91488-1015S	J-135
C5165X10X16MM	FF91488-1016S	J-135
C5165X12X18MM	FF91488-1218S	J-135
C5165X14X20MM	FF91488-1420S	J-135
C5165X20X30MM	FF91488-2030S	J-135
C5165X20X32MM	FF91488-2032S	J-135
C3059X12	FF91494-12S	J-64
C3059X16	FF91494-16S	J-64
C3059X2	FF91494-2S	J-64
C3059X4	FF91494-4S	J-64
C3059X6	FF91494-6S	J-64
C3059X8	FF91494-8S	J-64
4229X4	FF9767T04-S	J-56
4229X6	FF9767T06-S	J-56
4229X8	FF9767T08-S	J-56
4229X10	FF9767T10-S	J-56
4229X12	FF9767T12-S	J-56
4229X16	FF9767T16-S	J-56
4229X20	FF9767T20-S	J-56
4229X24	FF9767T24-S	J-56
4924X4	FF9768-04S	J-56
4924X6	FF9768-06S	J-56
4924X8	FF9768-08S	J-56
4924X10	FF9768-10S	J-56
4924X12	FF9768-12S	J-56
4924X16	FF9768-16S	J-56
4924X20	FF9768-20S	J-56
4924X24	FF9768-24S	J-56
4129X4	FF9863-04S	J-56
4129X6	FF9863-06S	J-56
4129X8	FF9863-08S	J-56
4129X10	FF9863-10S	J-56
4129X12	FF9863-12S	J-56

Part number catalog cross referencing index

Former WH Part Number	Eaton Part Number	Catalog Page
4129X16	FF9863-16S	J-56
4129X20	FF9863-20S	J-56
4129X24	FF9863-24S	J-56
MB5315X4X2	GG106-NP04-02	J-136
MB5315X4X4	GG106-NP04-04	J-136
MB5315X4X6	GG106-NP04-06	J-136
MB5315X4X8	GG106-NP04-08	J-136
MB5315X5X4	GG106-NP05-04	J-136
MB5315X6X4	GG106-NP06-04	J-136
MB5315X6X6	GG106-NP06-06	J-136
MB5315X6X8	GG106-NP06-08	J-136
MB5315X8X4	GG106-NP08-04	J-136
MB5315X8X6	GG106-NP08-06	J-136
MB5315X8X8	GG106-NP08-08	J-136
MB5315X8X12	GG106-NP08-12	J-136
MB5315X10X6	GG106-NP10-06	J-136
MB5315X10X8	GG106-NP10-08	J-136
MB5315X10X12	GG106-NP10-12	J-136
MB5315X12X8	GG106-NP12-08	J-136
MB5315X12X12	GG106-NP12-12	J-136
MB5315X12X16	GG106-NP12-16	J-136
MB5315X16X12	GG106-NP16-12	J-136
MB5315X16X16	GG106-NP16-16	J-136
MB5315X16X20	GG106-NP16-20	J-136
MB5315X20X20	GG106-NP20-20	J-136
MC5315X4X10	GG108-NP04-10	J-133
MC5315X4X12	GG108-NP04-12	J-133
MC5315X4X14	GG108-NP04-14	J-133
MC5315X6X14	GG108-NP06-14	J-133
MC5315X6X16	GG108-NP06-16	J-133
MC5315X8X18	GG108-NP08-18	J-133
MC5315X8X22	GG108-NP08-22	J-133
MC5315X10X20	GG108-NP10-20	J-133
MC5315X12X22	GG108-NP12-22	J-133
MC5315X12X27	GG108-NP12-27	J-133
MC5315X16X33	GG108-NP16-33	J-133
MC5315X20X42	GG108-NP20-42	J-133
MC5205X4X2	GG110-NP04-02	J-137
MC5205X4X4	GG110-NP04-04	J-137
MC5205X6X4	GG110-NP06-04	J-137
MC5205X6X6	GG110-NP06-06	J-137
MC5205X8X6	GG110-NP08-06	J-137
MC5205X8X8	GG110-NP08-08	J-137
MC5205X10X8	GG110-NP10-08	J-137
MC5205X12X12	GG110-NP12-12	J-137
MC5205X16X16	GG110-NP16-16	J-137
MB5515X4X4	GG306-NP04-04	J-137
MB5515X5X4	GG306-NP05-04	J-137
MB5515X6X4	GG306-NP06-04	J-137
MB5515X6X6	GG306-NP06-06	J-137
MB5515X8X6	GG306-NP08-06	J-137
MB5515X8X8	GG306-NP08-08	J-137
MB5515X10X12	GG306-NP10-12	J-137
MB5515X12X12	GG306-NP12-12	J-137
MB5515X16X16	GG306-NP16-16	J-137
MB5515X20X20	GG306-NP20-20	J-137
MC5515X4X10	GG308-NP04-10	J-133
MC5515X4X12	GG308-NP04-12	J-133
MC5515X6X14	GG308-NP06-14	J-133
MC5515X6X16	GG308-NP06-16	J-133
MC5515X8X18	GG308-NP08-18	J-133
MC5515X8X22	GG308-NP08-22	J-133
MC5515X10X18	GG308-NP10-18	J-133
MC5515X10X20	GG308-NP10-20	J-133
MC5515X10X22	GG308-NP10-22	J-133
MC5515X12X22	GG308-NP12-22	J-133
MC5515X12X27	GG308-NP12-27	J-133

Former WH Part Number	Eaton Part Number	Catalog Page
MC5515X16X33	GG308-NP16-33	J-133
MC5405X4X4	GG310-NP04-04	J-138
MC5405X5X4	GG310-NP05-04	J-138
MC5405X6X4	GG310-NP06-04	J-138
MC5405X6X6	GG310-NP06-06	J-138
MC5405X6X8	GG310-NP06-08	J-138
MC5405X8X6	GG310-NP08-06	J-138
MC5405X8X8	GG310-NP08-08	J-138
MC5405X10X12	GG310-NP10-12	J-138
MC5405X12X12	GG310-NP12-12	J-138
MC5405X16X16	GG310-NP16-16	J-138
MC5405X20X20	GG310-NP20-20	J-138
ML7105X6	WAL039842	
ML7105X8	WAL039843	
ML7105X10	WAL039844	
ML7105X12	WAL039845	
ML7105X15	WAL039846	
ML7105X18	WAL039847	
ML7105X22	WAL039848	
ML7105X28	WAL039849	
MH7105X6	WAL039852	
MH7105X8	WAL039853	
MH7105X10	WAL039854	
MH7105X12	WAL039855	
MH7105X14	WAL039856	
MH7105X16	WAL039857	
MH7105X20	WAL039858	
MH7105X25	WAL039859	
MH7105X30	WAL039860	
MH7105X38	WAL039861	
7165X6MM	WAL372404	
7165X8MM	WAL372405	
7165X10MM	WAL372406	
7165X12MM	WAL372407	
7165X15MM	WAL372408	
7165X18MM	WAL372409	
7165X22MM	WAL372410	
7165X28MM	WAL372411	
7165X14MM	WAL372414	
7165X16MM	WAL372415	
7165X20MM	WAL372416	
7165X25MM	WAL372417	
7165X30MM	WAL372418	

Please reference
Walterscheid
master catalog
for metric
tube fitting
components:
Literature
number
E-MEFI-
MC002-E1.

Steel adapters

J

Accessories

Protective guards and sleeves

Spring guards	K-2
Poly hose guard	K-3
Abrasion sleeve	K-3
Locator clamps	K-3
Hose bend restrictors	K-4
Firesleeve	K-4
Firesleeve tape	K-4
Guardian sleeve	K-5
Support clamp	K-6

Accessories to hose chart **K-7**

Ready-made hose assemblies

Air brake coil	K-16
Air compressor	K-17
Grease hose whip ends	K-18
Power trim	K-18
Air brake air chamber	K-19

Automotive, light truck gas/oil	K-20
Automotive, light truck universal-type filter	K-21

Hose assembly

Hose insertion gauge	K-22
Pressure gauge kit	K-22

Hose protection

Hose spacers	K-23
Hose protectors	K-23
Flaretite seals	K-24
Bundling sleeves	K-25
Bundling straps	K-26

Hose clamps

Round-wire clamps	K-28
E.F.I. hose clamp	K-28
Heavy-duty support clamps	K-28
Stainless steel band clamps	K-29

K



Accessories

Protective guards and sleeves

K

Round-wire spring guard

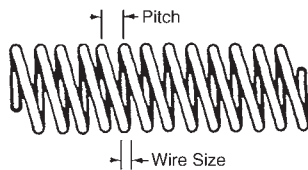
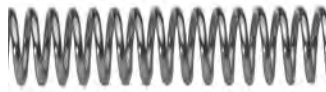

Spring guards should be considered for applications that call for tough, steel armor protection. They offer heavy-duty defense against cuts and abrasion, with the added benefit of kink resistance and the ability to mold hose assembly routing for applications requiring tight bends. Round-wire spring guards can be welded together for longer lengths.

Construction

Hot dipped Galvanized steel, chemically treated and oiled

Guard I.D.	Part Number	Package Length (ft)	Wire Diameter	Pitch
0.532	A1900	100	0.063	0.188
0.532	A1900-20	20	0.063	0.188
0.532	A1901	100	0.063	0.188
0.532	A1901-20	20	0.063	0.188
0.610	A1902	100	0.063	0.188
0.610	A1902-20	20	0.063	0.188
0.660	A1903	100	0.080	0.188
0.660	A1903-20	20	0.080	0.188
0.750	A1904	100	0.080	0.188
0.750	A1904-20	20	0.080	0.188
0.840	A1905	100	0.080	0.188
0.840	A1905-20	20	0.080	0.188
0.910	A1906	100	0.080	0.188
0.910	A1906-20	20	0.080	0.188
0.990	A1907	100	0.080	0.188
0.990	A1907-20	20	0.080	0.188
1.048	A1908	100	0.080	0.188
1.048	A1908-20	20	0.080	0.188
1.340	A1912	60	0.105	0.375
1.642	A1913	60	0.120	0.375
1.880	A1916	60	0.120	0.375
2.125	A1917	40	0.120	0.375
2.300	A1919	40	0.120	0.375

Flat-wire spring guard

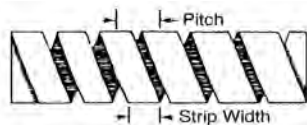

Spring guards should be considered for applications that call for tough, steel armor protection. They offer heavy-duty defense against cuts and abrasion, with the added benefit of kink resistance and the ability to mold hose assembly routing for applications requiring tight bends.

Construction

1/4" width Galvanized steel

Guard I.D.	Part Number	Package Length (ft)	Strip Thickness	Strip Width	Pitch
0.500	A2900	100	0.028	0.250	0.37
0.570	A2901	100	0.028	0.250	0.37
0.625	A2902	100	0.028	0.250	0.37
0.750	A2904	100	0.028	0.250	0.37
0.875	A2905	100	0.028	0.250	0.37
0.900	A2906	100	0.028	0.500	0.69
0.990	A2907	100	0.028	0.500	0.69
1.031	A2908	100	0.028	0.500	0.69
1.110	A2909	100	0.028	0.500	0.69
1.219	A2910	100	0.028	0.500	0.69
1.300	A2911	60	0.028	0.500	0.69
1.380	A2912	60	0.028	0.500	0.81
1.630	A2913	60	0.028	0.500	0.81
2.130	A2917	40	0.028	0.500	0.81
2.300	A2919	40	0.028	0.500	0.81

Heavy-duty poly hose guard



A heavy-duty hose guard can be easily placed around a single or bundle of hydraulic and pneumatic hose. It protects against abrasion and also provides crush resistance, reducing or eliminating costly premature hose failures.

Construction: High density Polyethylene

Operating temperature range

-100°F to +220°F

Color Black

Guard I.D.	Part Number	Wall Thickness	Guard O.D.	Roll Length(ft)
0.492	A9900	.069	.630	100
0.668	A9901	.086	.840	100
1.014	A9902	.118	1.250	100
1.600	A9903	.150	1.900	50
2.457	A9904	.209	2.875	50
3.065	A9905	.218	3.500	35

Benefits

Resists oils, lubricants, gasoline and most solvents.

Abrasion sleeve

MSHA Accepted ISO 6945



Abrasion sleeve is used to help safeguard hose covers from abrasions and cuts. The sleeve is also useful for bundling two or more hose assemblies together, adding to its protective qualities.

It is available in .045" thin-wall and .090" thick-wall sleeving.

Sleeve I.D.	.045" Thin Wall Part No.	.090" Thick Wall Part No.	Package Length* (ft)	Flat I.D.
0.90	A4900	A3900	100	1.32-1.51
1.06	A4901	A3901	100	1.57-1.76
1.22	A4902	A3902	100	1.82-2.01
1.35	A4903	A3903	100	2.03-2.21
1.66	A4904	A3904	100	2.63-2.87
1.81	A4905	A3905	100	2.75-2.94
2.19	A4906	A3906	100	3.43-3.53
2.62	A4907	A3907	100	4.02-4.21
2.80	A4908	A3908	100	4.43-4.62

*Package contains two pieces that are not less than 30 feet long each.

Note: Wall thickness is for single wall.

Note: Abrasion sleeve temp rating is 250°F.

Construction

Bulk continuous filament nylon

* Slide sleeve onto the hose before assembling the fittings. After assembly, clamp the sleeve over the fittings.

Application

- Agriculture
- Logging
- Construction
- Mining

Locator clamps

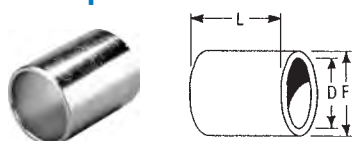

Locator clamps are designed for crimping to H14510 or H42510 hydraulic hose to provide a support for routing clamps. They are popular in Case® equipment applications.

Note: Crimp using collet T-400-5C and spacer ring T-400-62 (yellow), flat side up.

Hose I.D.	Part Number	L	D	F
5/8	A4910	1.60	1.084	1.25

Accessories

Protective guards and sleeves

K

Hose bend restrictors



For use in protecting the last section of hose at the fitting connection, bend restrictors are designed to allow for an appropriate degree of “bend” without compromising the integrity of hose assemblies. They are also recommended for hose assemblies that receive substantial handling, such as in pressure washer, air, oil, and hydraulic fluid transfer applications.

Construction

Plastisol MR 436 gloss PVC

Note: Colors red, blue, green and yellow available by special order.

Restrictor I.D.	Part Number	Restrictor Length (Inch)	Hose type application
0.530	A5953	6	H14504, H00904
0.625	A5962	6	H10404, H20906, H24504, H34504, H42504
0.690	A5969	6	H14506, H34506
0.750	A5975	7	H10406, H20908, H24506, H30006
0.840	A5984	7	H10408, H14508, H24508
0.875	A5987	7	H34508

Firesleeve



Firesleeve is a flame-resistant sheathing constructed of tightly woven fiberglass, which is coated with a specially compounded, highly temperature-resistant silicone rubber. Firesleeve offers protection in high temperature environments with heat extremes. It is not compatible with hydrocarbons.

Temperature range

Continuous exposure up to 500°F

Up to 2000°F for 15 to 20 minutes

Up to 3000°F for durations of 15 to 30 seconds

Color Red-orange

Sleeve I.D.	Part Number	Roll Length (ft)
0.50	A6908	100
0.63	A6910	100
0.75	A6912	100
0.88	A6914	100
1.00	A6916	100
1.25	A6920	100
1.50	A6924	100
1.75	A6928	100
2.00	A6932	50
2.25	A6936	50
3.00	A6948	50

Firesleeve tape

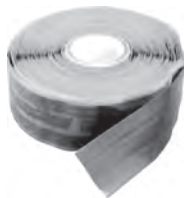

CAUTION

Tests should be conducted to determine the suitability of Firesleeve for each application.

Tape Coverage	Part Number	Roll Length
All sizes	A6900W	1x432

Firesleeve tape provides protection in high temperature environments. It acts as an end sealant in preventing moisture and hydraulic oils from wicking into the inner braids of Firesleeve.

Construction

High temperature-resistant, non-adhesive, silicone elastomer

Operating temperature

+475°F continuous

Guardian sleeve

FF90754

Eaton's Guardian sleeve is designed to provide protection against hydraulic hose failure by containing pressure and fluids that may escape during a hose burst or pinhole leak. With this new line of sight sleeving which meets industry standards, both equipment operators and the environment are guarded from the effects of hose failures.

Properties	Specification	Description
Burst pressure	16,000 psi	Capable to contain hose burst up to 16,000 psi
Pin hole leak pressure	4,000 psi	Sustained 4,000 psi pin hole deflection from focused 1mm pin hole
Abrasion cycles	250,000	Holds up to 250,000 abrasion cycles per ISO 6945

General and dimensional information

Part number	Nominal I.D. (in)	A - Flat Width (in) +/- 0.125	Weights in lbs per 300 ft Roll	Rolls per box
FF90754-68	0.68	1.290	7.43	8
FF90754-79	0.79	1.400	8.50	7
FF90754-91	0.91	1.590	9.70	6
FF90754-98	0.98	1.590	10.13	6
FF90754-106	1.06	1.825	11.10	5
FF90754-122	1.22	2.076	12.60	4
FF90754-142	1.42	2.390	14.50	4
FF90754-157	1.57	2.650	16.10	3
FF90754-173	1.73	2.910	17.70	3
FF90754-185	1.85	3.100	18.80	3
FF90754-209	2.09	3.470	21.10	2
FF90754-219	2.19	3.630	22.10	2
FF90754-238	2.38	3.925	23.90	2
FF90754-288	2.88	4.714	28.60	2
FF90754-366	3.66	5.938	36.10	1

Guardian sleeve selection chart

Suggested sleeve Part number	Sleeve I.D. (in)	Max hose OD that sleeve can accept (in)	Hose size as a ref.
FF90754-68	0.68	0.52	-4
FF90754-79	0.79	0.61	-4
FF90754-91	0.91	0.70	-6
FF90754-98	0.98	0.76	-6
FF90754-106	1.06	0.80	-6
FF90754-122	1.22	0.92	-8
FF90754-142	1.42	1.02	10
FF90754-157	1.57	1.13	10
FF90754-173	1.73	1.24	12
FF90754-185	1.85	1.34	16
FF90754-209	2.09	1.50	16
FF90754-219	2.19	1.54	20
FF90754-238	2.38	1.70	20
FF90754-288	2.88	2.00	20
FF90754-366	3.66	2.40	24



Construction: Denier: 1260

Melting Point: 215°C/420°F

Material: Polyamide 6, made with pre-dyed yarn

Dim. stability: Great resistance to sun, atmospheric agents and aging

Toxicity: Non-Toxic

Color: Black

Packing Requirements: Eaton Guardian Sleeve comes in a 300 foot roll with no more than 3 cuts per roll and no piece shorter than 30 feet.

Note: Must be ordered by the roll.

Guardian sleeve chemical compatibility

Chemical	Compatibility
Gasoline	Very Good
Oil	Very Good
Mineral and Vegetable Oil	Very Good
Ionic Metallic Solutions	Very Good
Alcohols	Very Good
Diluted Bases	Very Good
Diluted acids *	Good
Benzene	Very Good
Acetone	Very Good
Ether	Very Good
Carbon Tetrachloride	Very Good
Chlorine Based Solvent	Very Good
Mold, Bacteria, Moths	Very Good

*Strong and concentrated acids; ie. HCL or Formic Acid may have some corrosive action.

Assembly instructions

1. Select the correct sleeve part number for the hose.
2. Cut the sleeve 2 inches longer than the cut length of the hose to allow full hose bend radius.
3. The ends of the sleeves must be seared to prevent sleeve from fraying.
4. Slide the sleeve over the hose.
5. Properly assemble the hose ends.
6. Secure the sleeve over hose sockets with a metal banding product.

Features / Benefits

- The ultra tight weave resists oil spillage from hose failure
- Densely twisted polyamide resists wear
- 6 yarn offers optimum UV and abrasion protection
- Meets ASTM D6770 for abrasion resistance of textile webbing
- Meets abrasion standard ISO 6945
- Meets Fed-STD191-Test Method 5309 for abrasion
- Meets conductivity requirements of ISO 8031
- MSHA approved #IC-234/0
- Meets standard application procedures for acceptance of Flame Resistance Solid Products taken into mines

Accessories

Protective guards and sleeves

K

Hose support clamps

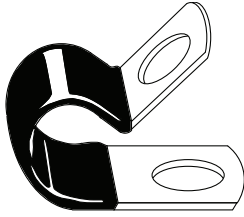









Support for long hose length to ensure proper hose routing in applications in which abrasion, moving parts, or heat are present.

Construction

C1010 steel with 1/32" thick black vinyl cushion, Zinc-plated

Note: Vinyl coating will withstand 300°F for 2 hours or 180°F for 2000 hours.

Clamping diameter	Part number	Bolt hole
1/4	HK0509	13/32
3/8	HK0709	13/32
7/16	HK0809	13/32
1/2	HK0913	13/32
9/16	HK1013	13/32
5/8	HK1113	13/32
11/16	HK1213	13/32
3/4	HK1313	13/32
13/16	HK1413	13/32
7/8	HK1513	13/32
15/16	HK1613	13/32
1	HK1713	13/32
1-1/16	HK1813	13/32
1-1/8	HK1913	17/32
1-3/16	HK2017	17/32
1-1/4	HK2117	17/32
1-3/8	HK2317	17/32
1-1/2	HK2517	17/32
1-9/16	HK2617	17/32
1-3/4	HK2917	17/32
1-7/8	HK3117	17/32
1-15/16	HK3217	17/32
2	HK3317	17/32
2-1/8	HK3417	17/32
2-5/8	HK3817	17/32









Hose Type	Dash Size	Hose clamp	Round-wire spring guard	Flat-wire spring guard	Nylon(.045) abrasion sleeve	Nylon (.090) abrasion sleeve	Silicone fiberglass Firesleeve	Poly hose guard	Guardian sleeve
									
H009	4	HK1013	A1901	A2901	A4900	A3900	A6910	A9901	FF90754-79
	5	HK1113	A1902	A2902	A4900	A3900	A6910	A9901	FF90754-79
	6	HK1213	A1903	A2904	A4900	A3900	A6912	A9901	FF90754-91
	8	HK1413	A1905	A2905	A4900	A3900	A6914	A9902	FF90754-122
H039	12	HK2317	A1912	A2911	A4903	A3903	A6924	A9903	FF90754-185
	16	HK2617	A1913	A2913	A4904	A3904	A6928	A9903	FF90754-219
	20	HK3117	A1916	A2917	A4906	A3906	A6932	A9904	FF90754-288
	24	HK3417	A1917	A2917	A4906	A3906	A6936	A9904	FF90754-366
H039H	32	HK3817	—	—	A4907	A3907	A6948	A9905	—
	12	HK2317	A1912	A2911	A4903	A3903	A6924	A9903	FF90754-185
	16	HK2617	A1913	A2913	A4904	A3904	A6928	A9903	FF90754-219
	20	HK3117	A1916	A2917	A4906	A3906	A6932	A9904	FF90754-288
H057	24	HK3417	A1917	A2917	A4906	A3906	A6936	A9904	FF90754-366
	32	HK3817	—	—	A4907	A3907	A6948	A9905	—
	3	HK0809	A1901	A2900	A4900	A3900	A6908	A9900	FF90754-68
	4	HK1013	A1901	A2901	A4900	A3900	A6910	A9901	FF90754-79
H059	5	HK1113	A1902	A2902	A4900	A3900	A6910	A9901	FF90754-79
	6	HK1213	A1903	A2904	A4900	A3900	A6912	A9901	FF90754-91
	4	HK1013	A1901	A2901	A4900	A3900	A6910	A9901	FF90754-79
	5	HK1113	A1902	A2902	A4900	A3900	A6910	A9901	FF90754-79
	6	HK1313	A1904	A2904	A4901	A3901	A6912	A9902	FF90754-98
	8	HK1413	A1905	A2905	A4901	A3901	A6914	A9902	FF90754-106
	10	HK1713	A1907	A2907	A4901	A3901	A6916	A9902	FF90754-142
H069	12	HK1913	A1910	A2909	A4902	A3902	A6920	A9903	FF90754-173
	16	HK2317	A1912	A2911	A4903	A3903	A6924	A9903	FF90754-185
	4	HK1013	A1902	A2901	A4900	A3900	A6910	A9901	FF90754-79
	5	HK1113	A1902	A2902	A4900	A3900	A6910	A9901	FF90754-79
	6	HK1313	A1904	A2904	A4900	A3900	A6912	A9902	FF90754-98
	8	HK1413	A1905	A2905	A4900	A3900	A6914	A9902	FF90754-106
	10	HK1713	A1907	A2907	A4901	A3901	A6916	A9902	FF90754-142
	12	HK1913	A1910	A2909	A4902	A3902	A6920	A9903	FF90754-157
H100	16	HK2317	A1912	A2911	A4903	A3903	A6924	A9903	FF90754-185
	20	HK2617	A1913	A2913	A4904	A3904	A6928	A9903	FF90754-219
	24	HK3117	A1916	A2917	A4905	A3905	A6932	A9904	FF90754-288
	32	HK3817	A1919	A2919	A4907	A3907	A6948	A9904	FF90754-366
	40	—	—	—	—	—	A6948	A9905	—
	4	HK1013	A1901	A2901	A4900	A3900	A6910	A9901	FF90754-79
	5	HK1013	A1902	A2901	A4900	A3900	A6910	A9901	FF90754-79
	6	HK1213	A1903	A2904	A4900	A3900	A6912	A9901	FF90754-91
H100	8	HK1413	A1905	A2905	A4900	A3900	A6914	A9902	FF90754-106
	10	HK1713	A1907	A2907	A4901	A3901	A6916	A9902	FF90754-142
	12	HK1813	A1912	A2909	A4902	A3902	A6920	A9903	FF90754-157

*Sizes indicated are based on Hose O.D. only. If sleeve is to be placed over fittings, a larger sleeve size may be required, depending on type of fitting used.









Accessories

Accessories to hose chart

K

Hose Type	Dash Size	Hose clamp	Round-wire spring guard	Flat-wire spring guard	Nylon(.045) abrasion sleeve	Nylon (.090) abrasion sleeve	Silicone fiberglass Firesleeve	Poly hose guard	Guardian sleeve
									
H101	4	HK1013	A1901	A2901	A4900	A3900	A6910	A9901	FF90754-79
	5	HK1013	A1902	A2901	A4900	A3900	A6910	A9901	FF90754-79
	6	HK1213	A1903	A2904	A4900	A3900	A6912	A9901	FF90754-91
	8	HK1413	A1905	A2905	A4900	A3900	A6914	A9902	FF90754-106
	10	HK1713	A1907	A2907	A4901	A3901	A6916	A9902	FF90754-142
	12	HK1813	A1912	A2909	A4902	A3902	A6920	A9903	FF90754-157
H1015	4	HK1113	A1903	A2904	A4900	A3900	A6910	A9901	FF90754-91
	6	HK1313	A1904	A2904	A4900	A3900	A6912	A9902	FF90754-98
	8	HK1513	A1906	A2906	A4900	A3900	A6914	A9902	FF90754-122
	10	HK1813	A1908	A2908	A4901	A3901	A6920	A9902	FF90754-142
	12	HK2017	A1912	A2910	A4902	A3902	A6920	A9903	FF90754-173
	16	HK2517	A1913	A2912	A4904	A3904	A6924	A9903	FF90754-209
	20	HK3117	A1916	A2917	A4905	A3905	A6932	A9904	FF90754-288
	24	HK3417	A1917	A2917	A4906	A3906	A6936	A9904	FF90754-366
H145	4	HK1013	A1901	A2901	A4900	A3900	A6910	A9901	FF90754-68
	6	HK1213	A1903	A2904	A4900	A3900	A6912	A9901	FF90754-91
	8	HK1413	A1905	A2905	A4900	A3900	A6914	A9902	FF90754-122
	10	HK1713	A1907	A2908	A4901	A3901	A6916	A9902	FF90754-142
	12	HK2017	A1912	A2910	A4902	A3902	A6920	A9903	FF90754-173
	16	HK2517	A1913	A2913	A4904	A3904	A6924	A9903	FF90754-209
H145R	4	HK1013	A1901	A2901	A4900	A3900	A6910	A9901	FF90754-68
	6	HK1213	A1904	A2904	A4900	A3900	A6912	A9901	FF90754-91
	8	HK1413	A1905	A2905	A4900	A3900	A6914	A9902	FF90754-122
	10	HK1713	A1908	A2908	A4901	A4901	A6916	A9902	FF90754-142
	12	HK2017	A1912	A2910	A4902	A3902	A6920	A9903	FF90754-173
	16	HK2517	A1913	A2913	A4904	A3904	A6924	A9903	FF90754-209
H166	4	HK1013	A1902	A2901	A4900	A3900	A6910	A9901	FF90754-79
	5	HK1113	A1902	A2902	A4900	A3900	A6910	A9901	FF90754-79
	6	HK1313	A1904	A2904	A4900	A3900	A6912	A9902	FF90754-98
	8	HK1413	A1905	A2905	A4900	A3900	A6914	A9902	FF90754-106
	10	HK1713	A1907	A2907	A4901	A3901	A6916	A9902	FF90754-142
	12	HK1913	A1910	A2910	A4902	A3902	A6920	A9903	FF90754-157
	16	HK2317	A1912	A2911	A4903	A3903	A6924	A9903	FF90754-185
	20	HK2617	A1913	A2913	A4904	A3904	A6928	A9903	FF90754-219
H169	6	HK1313	A1904	A2904	A4900	A3900	A6912	A9902	FF90754-91
	8	HK1413	A1905	A2905	A4900	A3900	A6914	A9902	FF90754-106
	10	HK1713	A1907	A2907	A4901	A3901	A6916	A9902	FF90754-142
	12	HK1913	A1912	A2910	A4902	A3902	A6920	A9903	FF90754-157
	16	HK2317	A1912	A2911	A4903	A3903	A6924	A9903	FF90754-185
	20	HK2617	A1913	A2913	A4904	A3904	A6928	A9903	FF90754-219
	24	HK3117	A1916	A2917	A4905	A3905	A6932	A9904	FF90754-288
32	HK3817	A1919	A2919	A4907	A3907	A6948	A9904	FF90754-366	

*Sizes indicated are based on Hose O.D. only. If sleeve is to be placed over fittings, a larger sleeve size may be required, depending on type of fitting used.









Hose Type	Dash Size	Hose clamp	Round-wire spring guard	Flat-wire spring guard	Nylon(.045) abrasion sleeve	Nylon (.090) abrasion sleeve	Silicone fiberglass Firesleeve	Poly hose guard	Guardian sleeve
									
H180	4	HK1013	A1901	A2901	A4900	A3900	A6910	A9901	FF90754-79
	6	HK1213	A1903	A2904	A4900	A3900	A6912	A9901	FF90754-91
	8	HK1413	A1905	A2905	A4900	A3900	A6914	A9902	FF90754-106
	10	HK1613	A1906	A2907	A4901	A3901	A6916	A9902	FF90754-122
	12	HK1813	A1908	A2908	A4901	A3901	A6920	A9903	FF90754-157
	16	HK2317	A1913	A2912	A4904	A3904	A6924	A9903	FF90754-209
	20	HK2917	A1913	A2917	A4905	A3905	A6928	A9904	FF90754-238
	24	HK3217	A1917	A2917	A4906	A3906	A6932	A9904	FF90754-288
	32	HK3817	—	—	A4907	A3907	A6948	A9905	—
H190	4	HK1013	A1902	A2901	A4900	A3900	A6910	A9901	FF90754-79
	6	HK1313	A1904	A2904	A4900	A3900	A6912	A9902	FF90754-91
	8	HK1413	A1905	A2905	A4900	A3900	A6914	A9902	FF90754-122
	10	HK1713	A1907	A2907	A4901	A3901	A6916	A9902	FF90754-142
	12	HK1913	A1912	A2909	A4902	A3902	A6920	A9903	FF90754-157
	16	HK2517	A1913	A2913	A4904	A3904	A6924	A9903	FF90754-209
	20	HK2917	A1916	A2917	A4905	A3905	A6928	A9904	FF90754-288
	24	HK3317	A1917	A2917	A4906	A3906	A6932	A9904	FF90754-288
	32	HK3817	—	—	A4907	A3907	A6948	A9905	—
H190H	4	HK1013	A1902	A2901	A4900	A3900	A6910	A9901	FF90754-79
	6	HK1313	A1904	A2904	A4900	A3900	A6912	A9902	FF90754-91
	8	HK1413	A1905	A2905	A4900	A3900	A6914	A9902	FF90754-122
	10	HK1713	A1907	A2907	A4901	A3901	A6916	A9902	FF90754-142
	12	HK1913	A1912	A2909	A4902	A3902	A6920	A9903	FF90754-157
	16	HK2517	A1913	A2913	A4904	A3904	A6924	A9903	FF90754-209
	20	HK2917	A1916	A2917	A4905	A3905	A6928	A9904	FF90754-288
	24	HK3417	A1917	A2917	A4906	A3906	A6936	A9904	FF90754-288
	32	HK3817	—	—	A4907	A3907	A6948	A9905	—
H201	4	HK1013	A1901	A2901	A4900	A3900	A6910	A9901	FF90754-79
	5	HK1113	A1902	A2902	A4900	A3900	A6910	A9901	FF90754-79
	6	HK1313	A1904	A2904	A4900	A3900	A6912	A9902	FF90754-91
	8	HK1413	A1905	A2905	A4900	A3900	A6914	A9902	FF90754-106
	10	HK1713	A1907	A2907	A4901	A3901	A6916	A9902	FF90754-142
	12	HK1913	A1912	A2909	A4902	A3902	A6920	A9903	FF90754-157
	16	HK2517	A1913	A2913	A4904	A3904	A6924	A9903	FF90754-209
H209	4	HK0913	A1901	A2900	A4900	A3900	A6908	A9900	FF90754-68
	6	HK1013	A1902	A2901	A4900	A3900	A6910	A9901	FF90754-79
	8	HK1313	A1904	A2904	A4900	A3900	A6912	A9902	FF90754-98
H213	4	HK1013	A1901	A2901	A4900	A3900	A6910	A9901	FF90754-68
	5	HK1113	A1902	A2902	A4900	A3900	A6910	A9901	FF90754-79
	6	HK1213	A1903	A2904	A4900	A3900	A6912	A9901	FF90754-91
	8	HK1413	A1905	A2905	A4900	A3900	A6914	A9902	FF90754-98
	10	HK1513	A1906	A2905	A4900	A3900	A6914	A9902	FF90754-122
	12	HK1713	A1907	A2907	A4901	A3901	A6916	A9902	FF90754-142
	16	HK2117	A1912	A2911	A4903	A3903	A6920	A9903	FF90754-173

*Sizes indicated are based on Hose O.D. only. If sleeve is to be placed over fittings, a larger sleeve size may be required, depending on type of fitting used.









Accessories

Accessories to hose chart

K

Hose Type	Dash Size	Hose clamp	Round-wire spring guard	Flat-wire spring guard	Nylon(.045) abrasion sleeve	Nylon (.090) abrasion sleeve	Silicone fiberglass Firesleeve	Poly hose guard	Guardian sleeve
									
H229	4	HK1013	A1902	A2901	A4900	A3900	A6910	A9901	FF90754-79
	6	HK1413	A1905	A2905	A4900	A3900	A6914	A9902	FF90754-98
	8	HK1613	A1907	A2907	A4901	A3901	A6916	A9902	FF90754-122
	10	HK1813	A1908	A2908	A4901	A3901	A6920	A9903	FF90754-142
	12	HK2317	A1912	A2911	A4903	A3903	A6924	A9903	FF90754-185
H239	4	HK1013	A1902	A2901	A4900	A3900	A6910	A9901	FF90754-79
	6	HK1313	A1904	A2904	A4900	A3900	A6912	A9902	FF90754-98
	8	HK1413	A1905	A2905	A4900	A3900	A6914	A9902	FF90754-122
	10	HK1713	A1907	A2907	A4901	A3901	A6916	A9902	FF90754-142
	12	HK1813	A1908	A2908	A4901	A3901	A6920	A9903	FF90754-142
	16	HK2317	A1912	A2911	A4903	A3903	A6924	A9903	FF90754-185
	20	HK2617	A1913	A2913	A4904	A3904	A6928	A9903	FF90754-219
H243	3	HK0709	A1901	A2900	A4900	A3900	A6908	A9900	FF90754-68
	4	HK0709	A1901	A2900	A4900	A3900	A6908	A9900	FF90754-68
	5	HK0809	A1901	A2900	A4900	A3900	A6908	A9900	FF90754-68
	6	HK0913	A1901	A2901	A4900	A3900	A6910	A9901	FF90754-79
	8	HK1113	A1904	A2904	A4900	A3900	A6912	A9902	FF90754-91
	12	HK1513	A1907	A2907	A4901	A3901	A6916	A9902	FF90754-122
	16	HK1913	A1912	A2911	A4903	A3903	A6924	A9903	FF90754-185
H245L	4	HK1013	A1902	A2901	A4900	A3900	A6910	A9901	FF90754-79
	6	HK1213	A1904	A2904	A4900	A3900	A6912	A9902	FF90754-91
	8	HK1513	A1906	A2905	A4900	A3900	A6914	A9902	FF90754-122
	10	HK1713	A1908	A2908	A4901	A3901	A6916	A9902	FF90754-142
	12	HK1913	A1912	A2910	A4902	A3902	A6920	A9903	FF90754-157
	16	HK2517	A1912	A2913	A4904	A3904	A6924	A9903	FF90754-209
	20	HK2917	A1916	A2917	A4905	A3905	A2928	A9904	FF90754-288
	24	HK3417	A1917	A2917	A4906	A3906	A6936	A9904	FF90754-366
H275	4	HK0913	A1901	A2900	A4900	A3900	A6908	A9900	FF90754-68
	6	HK1213	A1903	A2904	A4900	A3900	A6912	A9901	FF90754-91
	8	HK1413	A1905	A2905	A4900	A3900	A6914	A9902	FF90754-106
	10	HK1613	A1907	A2907	A4901	A3901	A6916	A9902	FF90754-122
	12	HK1813	A1912	A2909	A4901	A3901	A6920	A9903	FF90754-157
	16	HK2317	A1912	A2912	A4903	A3903	A6924	A9903	FF90754-185
	20	HK2917	A1916	A2917	A4905	A3905	A6928	A9904	FF90754-288
	24	HK3317	A1917	A2917	A4906	A3906	A6932	A9904	FF90754-288
H277	3	HK0709	A1901	A2900	A4900	A3900	A6908	A9900	FF90754-68
	4	HK0809	A1901	A2900	A4900	A3900	A6908	A9900	FF90754-68
	5	HK0913	A1901	A2900	A4900	A3900	A6908	A9900	FF90754-68
	6	HK1013	A1902	A2901	A4900	A3900	A6910	A9901	FF90754-79
	8	HK1213	A1904	A2904	A4900	A3900	A6912	A9902	FF90754-91
	12	HK1613	A1907	A2907	A4901	A3901	A6916	A9902	FF90754-122
	16	HK2017	A1912	A2911	A4903	A3903	A6924	A9903	FF90754-185

*Sizes indicated are based on Hose O.D. only. If sleeve is to be placed over fittings, a larger sleeve size may be required, depending on type of fitting used.









Hose Type	Dash Size	Hose clamp	Round-wire spring guard	Flat-wire spring guard	Nylon(.045) abrasion sleeve	Nylon (.090) abrasion sleeve	Silicone fiberglass Firesleeve	Poly hose guard	Guardian sleeve
									
H280	4	HK1013	A1902	A2901	A4900	A3900	A6910	A9901	FF90754-79
	6	HK1313	A1904	A2904	A4900	A3900	A6912	A9902	FF90754-91
	8	HK1513	A1905	A2905	A4900	A3900	A6914	A9902	FF90754-122
	10	HK1713	A1907	A2907	A4901	A3901	A6916	A9902	FF90754-142
	12	HK1913	A1912	A2910	A4902	A3902	A6920	A9903	FF90754-157
	16	HK2517	A1913	A2913	A4904	A3904	A6924	A9903	FF90754-209
	20	HK2917	A1916	A2917	A4905	A3905	A6928	A9904	FF90754-288
	24	HK3417	A1917	A2917	A4906	A3906	A6936	A9904	FF90754-366
	32	HK3817	—	—	A4907	A3907	A6948	A9905	—
H285	3	HK0709	A1901	A2900	A4900	A3900	A6908	A9900	FF90754-68
	4	HK0913	A1901	A2900	A4900	A3900	A6908	A9900	FF90754-68
	5	HK1013	A1902	A2901	A4900	A3900	A6910	A9901	FF90754-79
	6	HK1113	A1902	A2902	A4900	A3900	A6910	A9901	FF90754-79
	8	HK1413	A1905	A2905	A4900	A3900	A6914	A9902	FF90754-98
	10	HK1513	A1906	A2905	A4900	A3900	A6914	A9902	FF90754-122
	12	HK1813	A1908	A2908	A4901	A3901	A6920	A9903	FF90754-157
	16	HK2317	A1912	A2912	A4903	A3903	A6924	A9903	FF90754-185
	20	HK2917	A1916	A2917	A4905	A3905	A6928	A9904	FF90754-238
	24	HK3317	A1917	A2917	A4906	A3906	A6932	A9904	FF90754-288
		32	HK3817	—	—	A4907	A3907	A6948	A9905
H290	4	HK1113	A1902	A2902	A4900	A3900	A6910	A9901	FF90754-79
	6	HK1413	A1905	A2905	A4900	A3900	A6914	A9902	FF90754-98
	8	HK1613	A1906	A2906	A4900	A3900	A6916	A9902	FF90754-122
	10	HK1813	A1908	A2908	A4901	A3901	A6920	A9902	FF90754-142
	12	HK2017	A1912	A2910	A4902	A3902	A6920	A9903	FF90754-173
	16	HK2617	A1913	A2913	A4904	A3904	A6928	A9903	FF90754-219
	20	HK3217	A1917	A2917	A4906	A3906	A6932	A9904	FF90754-288
	24	HK3817	A1919	A2919	A4906	A3906	A6936	A9904	FF90754-366
		32	HK3817	—	—	A4907	A3907	A6948	A9905
H290H	4	HK1113	A1902	A2902	A4900	A3900	A6912	A9901	FF90754-79
	6	HK1413	A1905	A2905	A4900	A3900	A6914	A9902	FF90754-98
	8	HK1513	A1906	A2905	A4900	A3900	A6924	A9902	FF90754-122
	10	HK1713	A1908	A2908	A4901	A3901	A6916	A9902	FF90754-142
	12	HK2017	A1912	A2910	A4902	A3902	A6920	A9903	FF90754-173
	16	HK2517	A1913	A2913	A4904	A3904	A6924	A9903	FF90754-209
	20	HK3217	A1917	A2917	A4906	A3906	A6932	A9904	FF90754-288
	24	HK3817	A1919	A2919	A4906	A3906	A6936	A9904	FF90754-366
		32	—	—	—	A4908	A3908	A6948	A9905
H332	4	HK1013	A1901	A2901	A4900	A3900	A6910	A9901	FF90754-79
	6	HK1213	A1903	A2904	A4900	A3900	A6912	A9901	FF90754-91
	8	HK1413	A1905	A2905	A4900	A3900	A6914	A9902	FF90754-106
	10	HK1713	A1907	A2907	A4901	A3901	A6916	A9902	FF90754-142
	12	HK1913	A1912	A2910	A4902	A3902	A6920	A9903	FF90754-157
H400	10	HK1013	A1908	A2908	A4901	A3901	A6920	A9903	FF90754-142
	12	HK1313	A1912	A2910	A4902	A3902	A6920	A9903	FF90754-173

*Sizes indicated are based on Hose O.D. only. If sleeve is to be placed over fittings, a larger sleeve size may be required, depending on type of fitting used.









Accessories

Accessories to hose chart

K

Hose Type	Dash Size	Hose clamp	Round-wire spring guard	Flat-wire spring guard	Nylon(.045) abrasion sleeve	Nylon (.090) abrasion sleeve	Silicone fiberglass Firesleeve	Poly hose guard	Guardian sleeve
									
H421	4	HK1013	A1902	A2901	A4900	A3900	A6910	A9901	FF90754-79
	6	HK1413	A1905	A2905	A4900	A3900	A6914	A9902	FF90754-91
H429	8	HK1313	A1904	A2904	A4900	A3900	A6912	A9902	FF90754-91
	10	HK1413	A1905	A2905	A4900	A3900	A6914	A9902	FF90754-106
H430	6	HK1413	A1905	A2905	A4900	A3900	A6914	A9902	FF90754-122
	8	HK1613	A1907	A2907	A4901	A3901	A6916	A9902	FF90754-142
	10	HK1913	A1912	A2909	A4902	A3902	A6920	A9903	FF90754-157
	12	HK2117	A1912	A2910	A4902	A3902	A6920	A9903	FF90754-173
	16	HK2517	A1913	A2913	A4904	A3904	A6924	A9903	FF90754-219
	20	HK3117	A1916	A2917	A4906	A3906	A6932	A9904	FF90754-288
	24	HK3417	A1917	A2917	A4906	A3906	A6936	A9904	FF90754-366
	32	—	—	—	A4908	A3908	A6948	A9905	—
H430R	6	HK1413	A1905	A2905	A4900	A3900	A6914	A9902	FF90754-122
	8	HK1613	A1907	A2907	A4901	A3901	A6916	A9902	FF90754-142
	10	HK1913	A1912	A2909	A4902	A3902	A6920	A9903	FF90754-157
	12	HK2117	A1912	A2910	A4902	A3902	A6920	A9903	FF90754-173
	16	HK2617	A1913	A2913	A4904	A3904	A6928	A9903	FF90754-219
	20	HK3117	A1916	A2917	A4906	A3906	A6932	A9904	FF90754-288
	24	HK3417	A1917	A2917	A4906	A3906	A6936	A9904	FF90754-366
	32	—	—	—	A4908	A3908	A6948	A9905	—
H464	12	HK2317	A1912	A2911	A4903	A3903	A6924	A9903	FF90754-185
	16	HK2617	A1913	A2913	A4904	A3904	A6928	A9903	FF90754-219
	20	HK3117	A1916	A2917	A4905	A3905	A6932	A9904	FF90754-288
	24	HK3417	A1917	A2917	A4906	A3906	A6936	A9904	FF90754-366
	32	—	—	—	A4908	A3908	A6948	A9905	—
H471	12	HK2117	A1912	A2911	A4903	A3903	A6924	A9903	FF90754-173
	16	HK2617	A1913	A2913	A4904	A3904	A6928	A9903	FF90754-219
	20	HK3117	A1916	A2917	A4906	A3906	A6932	A9904	FF90754-288
	24	HK3817	A1919	A2919	A4906	A3906	A6936	A9904	FF90754-366
	32	—	—	—	—	—	A6948	A9905	—
H545	4	HK1013	A1901	A2901	A4900	A3900	A6910	A9901	FF90754-79
	6	HK1213	A1903	A2904	A4900	A3900	A6912	A9901	FF90754-91
	8	HK1513	A1905	A2905	A4900	A3900	A6914	A9902	FF90754-122
	10	HK1713	A1907	A2907	A4901	A3901	A6916	A9902	FF90754-142
	12	HK2017	A1912	A2910	A4902	A3902	A6920	A9903	FF90754-173
	16	HK2517	A1913	A2913	A4904	A3904	A6924	A9903	FF90754-209
H569	4	HK1013	A1902	A2901	A4900	A3900	A6910	A9901	FF90754-79
	5	HK1113	A1902	A2902	A4900	A3900	A6910	A9901	FF90754-79
	6	HK1313	A1904	A2904	A4900	A3900	A6912	A9902	FF90754-98
	8	HK1413	A1905	A2905	A4900	A3900	A6914	A9902	FF90754-106
	10	HK1713	A1907	A2907	A4901	A3901	A6916	A9902	FF90754-142
	12	HK1913	A1912	A2910	A4902	A3902	A6920	A9903	FF90754-157
	16	HK2317	A1912	A2911	A4903	A3903	A6924	A9903	FF90754-185
20	HK2617	A1913	A2913	A4904	A3904	A6928	A9903	FF90754-219	

*Sizes indicated are based on Hose O.D. only. If sleeve is to be placed over fittings, a larger sleeve size may be required, depending on type of fitting used.









Hose Type	Dash Size	Hose clamp	Round-wire spring guard	Flat-wire spring guard	Nylon(.045) abrasion sleeve	Nylon (.090) abrasion sleeve	Silicone fiberglass Firesleeve	Poly hose guard	Guardian sleeve
									
H757	6	HK1113	A1902	A2902	A4900	A3900	A6910	A9901	FF90754-79
	8	HK1313	A1904	A2904	A4900	A3900	A6912	A9902	FF90754-98
	10	HK1413	A1905	A2905	A4900	A3900	A6914	A9902	FF90754-106
	12	HK1713	A1907	A2907	A4901	A3901	A6916	A9902	FF90754-142
EC038	4	HK1213	A1904	A2904	A4900	A3900	A6912	A9902	FF90754-91
	6	HK1413	A1905	A2905	A4900	A3900	A6914	A9902	FF90754-106
	8	HK1613	A1907	A2907	A4901	A3901	A6916	A9902	FF90754-122
EC810	12	HK2117	A1912	A2912	A4905	A3905	A6928	A9903	FF90754-142
	16	HK2517	A1913	A2913	A4906	A3906	A6936	A9903	FF90754-157
	20	HK3317	A1917	A2917	A4906	A3906	A6932	A9904	FF90754-209
	24	HK3817	A1919	A2919	A4907	A3907	A6948	A9904	FF90754-238
	32	—	—	—	A4908	A3908	A6948	A9905	FF90754-288
EC910	8	HK1713	A1908	A2908	A4901	A3901	A6920	A9902	FF90754-142
	12	HK2317	A1912	A2912	A4903	A3903	A6924	A9903	FF90754-185
	13	HK2917	A1913	A2913	A4904	A3904	A6928	A9903	FF90754-238
H0106	4	HK1013	A1902	A2901	A4900	A3900	A6910	A9901	FF90754-79
	5	HK1213	A1904	A2904	A4900	A3900	A6912	A9901	FF90754-91
	6	HK1313	A1905	A2904	A4900	A3900	A6912	A9902	FF90754-98
	8	HK1513	A1906	A2905	A4900	A3900	A6914	A9902	FF90754-122
	10	HK1713	A1908	A2907	A4901	A3901	A6916	A9902	FF90754-142
	12	HK2017	A1912	A2910	A4902	A3902	A6920	A9903	FF90754-173
H1719	10	HK1513	A1906	A2905	A4900	A3900	A6914	A9902	FF90754-122
	12	HK1813	A1912	A2909	A4902	A3902	A6920	A9903	FF90754-157
H1776	4	HK1113	A1903	A2902	A4900	A3900	A6910	A9901	FF90754-79
	6	HK1313	A1904	A2904	A4900	A3900	A6912	A9902	FF90754-98
	8	HK1613	A1906	A2906	A4901	A3901	A6916	A9902	FF90754-122
	10	HK1713	A1908	A2908	A4901	A3901	A6920	A9902	FF90754-142
	12	HK2017	A1912	A2910	A4902	A3902	A6920	A9903	FF90754-173
	16	HK2517	A1913	A2913	A4904	A3904	A6924	A9903	FF90754-209
	20	HK2917	A1916	A2917	A4905	A3905	A6932	A9904	FF90754-288
	24	HK3317	A1917	A2917	A4906	A3906	A6936	A9904	FF90754-366
H1777	4	HK0913	A1901	A2901	A4900	A3900	A6910	A9901	FF90754-68
	5	HK1213	A1903	A2904	A4900	A3900	A6912	A9901	FF90754-91
	6	HK1213	A1904	A2904	A4900	A3900	A6912	A9902	FF90754-91
	8	HK1513	A1905	A2905	A4900	A3900	A6914	A9902	FF90754-122
H1812	4	HK1113	A1902	A2902	A4900	A3900	A6910	A9901	FF90754-79
	6	HK1313	A1904	A2904	A4900	A3900	A6912	A9902	FF90754-98
	8	HK1613	A1906	A2906	A4901	A3901	A6916	A9902	FF90754-122
	10	HK1713	A1908	A2908	A4901	A3901	A6920	A9902	FF90754-142
	12	HK2017	A1912	A2910	A4902	A3902	A6920	A9903	FF90754-173
	16	HK2517	A1913	A2913	A4904	A3904	A6924	A9903	FF90754-209
	20	HK2917	A1916	A2917	A4905	A3905	A6932	A9904	FF90754-288
	24	HK3317	A1917	A2917	A4906	A3906	A6936	A9904	FF90754-366

*Sizes indicated are based on Hose O.D. only. If sleeve is to be placed over fittings, a larger sleeve size may be required, depending on type of fitting used.

Accessories









Accessories to hose chart

K

Hose Type	Dash Size	Hose clamp	Round-wire spring guard	Flat-wire spring guard	Nylon(.045) abrasion sleeve	Nylon (.090) abrasion sleeve	Silicone fiberglass Firesleeve	Poly hose guard	Guardian sleeve
									
H1981	4	HK0913	A1901	A2901	A4900	A3900	A6910	A9901	FF90754-68
	5	HK1213	A1903	A2904	A4900	A3900	A6912	A9901	FF90754-91
	6	HK1313	A1904	A2904	A4900	A3900	A6912	A9902	FF90754-91
	8	HK1413	A1905	A2905	A4900	A3900	A6914	A9902	FF90754-122
	12	HK2117	A1912	A2910	A4902	A3902	A6920	A9903	FF90754-173
H1982	4	HK1213	A1903	A2904	A4900	A3900	A6912	A9901	FF90754-91
	5	HK1313	A1904	A2904	A4900	A3900	A6912	A9902	FF90754-91
	6	HK1313	A1905	A2905	A4900	A3900	A6914	A9902	FF90754-98
	8	HK1613	A1906	A2906	A4901	A3901	A6916	A9902	FF90754-122
	10	HK1813	A1908	A2909	A4902	A3902	A6920	A9903	FF90754-157
	12	HK1913	A1912	A2909	A4902	A3902	A6920	A9903	FF90754-157
	16	HK2517	A1913	A2913	A4904	A3904	A6924	A9903	FF90754-209
H1987	10	HK1713	A1907	A2907	A4901	A3901	A6916	A9902	FF90754-142
	12	HK1913	A1912	A2909	A4902	A3902	A6920	A9903	FF90754-157
H9949	4	HK1113	A1902	A2902	A4900	A3900	A6910	A9901	FF90754-79
	6	HK1313	A1904	A2904	A4900	A3900	A6912	A9902	FF90754-98
	8	HK1613	A1906	A2906	A4901	A3901	A6916	A9902	FF90754-122
	12	HK2017	A1912	A2910	A4902	A3902	A6920	A9903	FF90754-173
	16	HK2517	A1913	A2913	A4904	A3904	A6924	A9903	FF90754-209
35FH	40	HK0913	A1901	A2901	A4900	A3900	A6910	A9901	FF90754-68
	50	HK1013	A1902	A2901	A4900	A3900	A6910	A9901	FF90754-79
	60	HK1213	A1903	A2904	A4900	A3900	A6912	A9901	FF90754-91
GH001	4	HK0913	A1901	A2900	A4900	A3900	A6908	A9900	FF90754-68
	6	HK1113	A1902	A2902	A4900	A3900	A6910	A9901	FF90754-79
	8	HK1313	A1904	A2904	A4900	A3900	A6912	A9902	FF90754-98
	10	HK1413	A1905	A2905	A4900	A3900	A6914	A9902	FF90754-122
	12	HK1713	A1908	A2908	A4901	A3901	A6920	A9903	FF90754-142
	16	HK2117	A1912	A2911	A4903	A3903	A6924	A9903	FF90754-185
FC800	12	HK1913	A1912	A2909	A4902	A3902	A6920	A9903	FF90754-157
	16	HK2517	A1913	A2913	A4904	A3904	A6924	A9903	FF90754-209
	20	HK2617	A1913	A2913	A4904	A3904	A6928	A9903	FF90754-238
	24	HK3117	A1916	A2917	A4906	A3906	A6932	A9904	FF90754-288
S-Series	3	HK0709	A1901	A2900	A4900	A3900	A6908	A9900	FF90754-68
	4	HK0709	A1901	A2900	A4900	A3900	A6908	A9900	FF90754-68
	5	HK0809	A1901	A2900	A4900	A3900	A6908	A9900	FF90754-68
	6	HK0913	A1901	A2901	A4900	A3900	A6908	A9900	FF90754-68
	8	HK1113	A1902	A2902	A4900	A3900	A6910	A9901	FF90754-79
	10	HK1213	A1904	A2904	A4900	A3900	A6912	A9902	FF90754-91
	12	HK1413	A1905	A2905	A4900	A3900	A6914	A9902	FF90754-122
	16	HK1913	A1912	A2909	A4902	A3902	A6920	A9903	FF90754-157
	16Z	HK2017	A1912	A2910	A4902	A3902	A6920	A9903	FF90754-173
20Z	HK2517	A1913	A2913	A4904	A3904	A6924	A9903	FF90754-209	

*Sizes indicated are based on Hose O.D. only. If sleeve is to be placed over fittings, a larger sleeve size may be required, depending on type of fitting used.

*Sizes indicated are based on Hose O.D. only. If sleeve is to be placed over fittings, a larger sleeve size may be required, depending on type of fitting used.

Hose Type	Dash Size	Hose clamp	Round-wire spring guard	Flat-wire spring guard	Nylon(.045) abrasion sleeve	Nylon (.090) abrasion sleeve	Silicone fiberglass Firesleeve	Poly hose guard	Guardian sleeve
									
SC-Series	3	HK0709	A1901	A2900	A4900	A3900	A6908	A9900	FF90754-68
	4	HK0709	A1901	A2900	A4900	A3900	A6908	A9900	FF90754-68
	5	HK0809	A1901	A2900	A4900	A3900	A6908	A9900	FF90754-68
	6	HK0913	A1901	A2901	A4900	A3900	A6908	A9900	FF90754-68
	8	HK1113	A1902	A2902	A4900	A3900	A6910	A9901	FF90754-79
	10	HK1213	A1904	A2904	A4900	A3900	A6912	A9902	FF90754-91
	12	HK1413	A1905	A2905	A4900	A3900	A6914	A9902	FF90754-122
	16	HK1913	A1912	A2909	A4902	A3902	A6920	A9903	FF90754-157
S-TW Series	4	HK0709	A1901	A2900	A4900	A3900	A6908	A9900	FF90754-68
	5	HK0809	A1901	A2900	A4900	A3900	A6908	A9900	FF90754-68
	6	HK0913	A1901	A2901	A4900	A3900	A6908	A9900	FF90754-68
	7	HK1013	A1902	A2901	A4900	A3900	A6910	A9901	FF90754-79
	8	HK1013	A1902	A2901	A4900	A3900	A6910	A9901	FF90754-79
	10	HK1213	A1904	A2904	A4900	A3900	A6912	A9902	FF90754-91
	12	HK1413	A1905	A2905	A4900	A3900	A6914	A9902	FF90754-106
	14	HK1713	A1907	A2907	A4901	A3901	A6916	A9902	FF90754-142
	16	HK1813	A1912	A2909	A4902	A3902	A6920	A9903	FF90754-157
	18Z	HK2117	A1912	A2911	A4903	A3903	A6924	A9903	FF90754-185
SC-TW Series	4	HK0709	A1901	A2900	A4900	A3900	A6908	A9900	FF90754-68
	5	HK0809	A1901	A2900	A4900	A3900	A6908	A9900	FF90754-68
	6	HK0913	A1901	A2901	A4900	A3900	A6908	A9900	FF90754-68
	7	HK1013	A1902	A2901	A4900	A3900	A6910	A9901	FF90754-79
	8	HK1013	A1902	A2901	A4900	A3900	A6910	A9901	FF90754-79
	10	HK1213	A1904	A2904	A4900	A3900	A6912	A9902	FF90754-91
	12	HK1413	A1905	A2905	A4900	A3900	A6914	A9902	FF90754-106
	14	HK1613	A1907	A2907	A4901	A3901	A6916	A9902	FF90754-142
	16	HK1813	A1912	A2909	A4902	A3902	A6920	A9903	FF90754-157
	18Z	HK2117	A1912	A2911	A4903	A3903	A6924	A9903	FF90754-185
HI-PSI Series	4	HK0809	A1900	A2900	A4900	A3900	A6908	A9900	FF90754-68
	6	HK1013	A1900	A2901	A4900	A3900	A6910	A9901	FF90754-79
	8	HK1213	A1903	A2904	A4900	A3900	A6912	A9901	FF90754-91
	10	HK1413	A1905	A2905	A4900	A3900	A6914	A9902	FF90754-106
	12	HK1713	A1908	A2908	A4901	A3901	A6916	A9902	FF90754-142
	16	HK2317	A1912	A2912	A4903	A3903	A6924	A9903	FF90754-185
	20	HK2917	A1913	A2913	A4904	A3904	A6928	A9904	FF90754-238
	24	HK3117	A1916	A2917	A4906	A3906	A6932	A9904	FF90754-288
	24	HK3117	A1916	A2917	A4906	A3906	A6932	A9904	FF90754-288
	32	HK3817	—	—	A4907	A3907	A6948	A9904	—
8000 Series	8	HK1513	A1905	A2905	A4900	A3900	A6914	A9902	FF90754-122
	12	HK1913	A1912	A2910	A4902	A3902	A6920	A9903	FF90754-157
	16	HK2317	A1913	A2912	A4904	A3904	A6924	A9903	FF90754-209
	20	HK2917	A1913	A2913	A4904	A3904	A6928	A9904	FF90754-238
	24	HK3117	A1916	A2917	A4906	A3906	A6932	A9904	FF90754-288
	32	HK3817	—	—	A4907	A3907	A6948	A9904	—
8500 Series	8	HK1513	A1905	A2905	A4900	A3900	A6914	A9902	FF90754-122
	12	HK1913	A1912	A2910	A4902	A3902	A6920	A9903	FF90754-157
	16	HK2317	A1913	A2912	A4904	A3904	A6924	A9903	FF90754-209
	20	HK2917	A1913	A2913	A4904	A3904	A6928	A9904	FF90754-238
	24	HK3117	A1916	A2917	A4906	A3906	A6932	A9904	FF90754-288
	32	HK3817	—	—	A4907	A3907	A6948	A9904	—

Accessories

Ready-made hose assemblies

K

15CA Eclipse Air brake coil

Meets: SAE J844 Type B, DOT-FMVSS 106, (49 FR571.106)



Part number	Description	Valve pigtail length		Male ends				Working length	
				Valve		Gladhand			
		mm	in	mm	in	mm	in	mm	ft
15CA12-12	15' WL abt coil set w/ 12" pigtails	304,8	12	12,7	0.50	12,7	0.50	4,6	15
15CA48-12	15' WL abt coil set w/ 48" pigtails	1.219,2	48	12,7	0.50	12,7	0.50	4,6	15
15CAR12-12	15' WL single, red abt coil w/ 12" pigtails	304,8	12	12,7	0.50	12,7	0.50	4,6	15
15CAB12-12	15' WL single, blue abt coil w/ 12" pigtails	304,8	12	12,7	0.50	12,7	0.50	4,6	15
15CAR48-12	15' WL single, red abt coil w/ 48" pigtails	1.219,2	48	12,7	0.50	12,7	0.50	4,6	15
15CAB48-12	15' WL single, blue abt coil w/ 48" pigtails	1.219,2	48	12,7	0.50	12,7	0.50	4,6	15
12CA12-12	12' WL abt coils set w/ 12" pigtails	304,8	12	12,7	0.50	12,7	0.50	3,7	17
12CAR12-12	12' WL single, red abt coil w/ 12" pigtails	304,8	12	12,7	0.50	12,7	0.50	3,7	17
12CAB12-12	12' WL single, blue abt coil w/ 12" pigtails	304,8	12	12,7	0.50	12,7	0.50	3,7	17
20CA12-12	20' WL abt coil set w/ 12" pigtails	304,8	12	12,7	0.50	12,7	0.50	6,1	20

Construction

Tube: Synflex Eclipse air brake tubing, 100% polyamide

Reinforcement:

Polyester yarn

Brass end fitting with corrosion resistant spring guard

Operating parameters

-54°C to +93°C
(-65°F to +200°F)

Application

- Articulating connections for air brake line systems (connections between towed and towing motor vehicle)
- Tractor-to-trailer air connections used in extremely low temperatures

Features

- Superior abrasion resistance
- Excellent return and coil memory
- Enhanced flexibility and extension
- Brass end fittings with corrosion resistant spring guards

WARNING: California Proposition 65, see page A-2.

Gladhand couplings

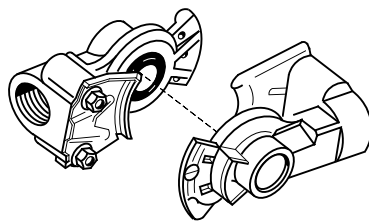

Part number

Part number	Description
W79850	Service – Signal (Connects only to service)
W79851	Emergency – Supply line (Connects only to emergency)
W76150	Universal (Connects to all three styles)
W14630**	Gladhand Seal

** For use with W79850, W79851, and W76150 gladhands

Construction

Die cast aluminum body

Features

- Conform to SAE J318
- Connect to 1/2" pipe

3SCE Eclipse Fifth-wheel slider coil

Meets: SAE J844 Type B, DOT-FMVSS 106, (49 FR571.106)



Construction

Tube: Synflex Eclipse air brake tubing, 100% polyamide

Reinforcement:

Polyester yarn

Brass end fitting with corrosion resistant spring guard

Operating parameters

-54°C to +93°C
(-65°F to +200°F)

Part number	Valve pigtail length		End fitting	Working length		Retracted length	
	mm	in		mm	ft	mm	in
3SCE-0303304-033	88,9	3.50	None	1.371,6	54.00	254,0	10.00
3SCE-0303304-166	88,9	3.50	1/4" male pipe	1.371,6	54.00	254,0	10.00

Application

- Articulating connections for air brake line systems (connections between towed and towing motor vehicle)
- Tractor-to-trailer air connections used in extremely low temperatures with enhanced flexibility and extension

WARNING: California Proposition 65, see page A-2.

Air Compressor discharge Teflon hose assembly

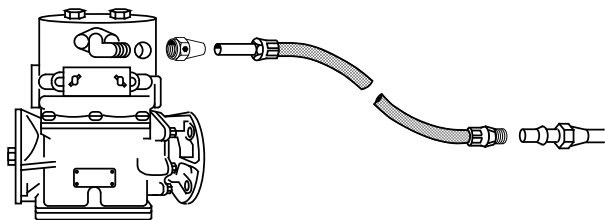

Ready-made hose Teflon assemblies eliminate tubing failures caused by vibration and heat. They make excellent replacements for troublesome copper tubing running from the air compressor discharge to the reservoir. The assemblies are easy to install with standard air brake nuts and sleeves. No special fittings or adapters are needed.

Maximum working pressure

1,000 psi

Operating temperature range

-65°F to +450°F
(-18°C to +232°C)

Standpipe to Standpipe



Description	Length	Part number
5/8" hose I.D. – 5/8" tube	24"	WTT024
	36"	WTT036
5/8" hose I.D. – 3/4" tube	36"	WTT236

SAE 45° Flare to SAE 45° Flare



Description	Length	Part number
1/2" hose I.D. – 5/8" tube	34"	W44034
	38"	W44038
	40"	W44040
	42"	W44042
	48"	W44048
	50"	W44050
	52"	W44052
	54"	W44054
	67"	W44067

Teflon is a trademark of The Chemours Company FC, LLC used under license by Eaton.

Accessories

Ready-made hose assemblies

K

Grease hose whip ends for high-pressure grease applications

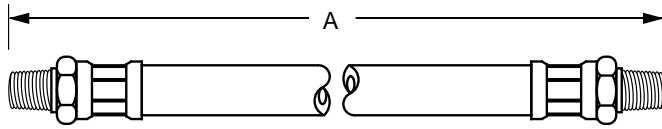

Part Number	Tube O.D.	Male Pipe	Working Length	Pigtail Length
11312	1/8-27	3/16"	12"	Rubber
11318	1/8-27	3/16"	18"	Rubber
11358	1/8-27	3/16"	18"	Nylon

Note: Use with hand-operated grease gun only!

Maximum operating pressure

3,000 psi

Operating temperature range

-40°F to +200°F (-40°C to +93°C)

Hose Part No.

H993903

Power trim Teflon hose assembly

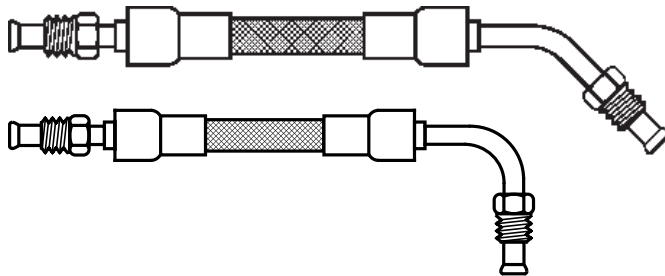

Part Number	Overall Length	Fitting Description
1909	14-1/2"	3/16" Inv. Nut Straight x 3/16" Inv. Nut 90° Elbow
1910	14-1/2"	3/16" Inv. Nut Straight x 3/16" Inv. Nut 45° Elbow

Teflon is a trademark of The Chemours Company FC, LLC used under license by Eaton.

Expand service to marinas with the inboard/outboard power trim Teflon hose assemblies, available in the most popular size, 3/16" I.D., 14-1/2" long, with inverted nut end styles.

Marine applications will benefit from the non-aging and temperature resistant qualities of Teflon, plus the corrosion resistance of 300 Series stainless steel fittings and braid.

Maximum operating pressure

3,000 psi

Operating temperature range

-65°F to +450°F

Air brake air chamber hose lines

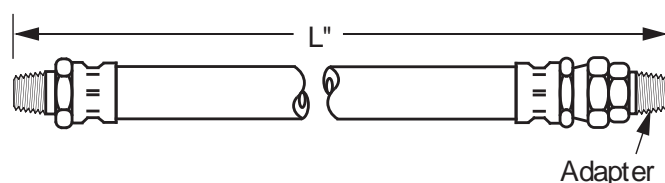

Features / Benefits

- Low cost
- Ready to install
- Available in both 3/8" and 1/2" I.D.

Hose Part No.

EC038 Weatherhead air brake hose

Hose Assembly I.D.	Male pipe	Air brake swivel*	Length L	Factory made assembly Part number**
1/2"	3/8"	3/8"	15"	38353-01500
1/2"	3/8"	3/8"	16"	38353-01600
1/2"	3/8"	3/8"	18"	38353-01800
1/2"	3/8"	3/8"	19"	38353-01900
1/2"	3/8"	3/8"	20-3/8"	38353-02037
1/2"	3/8"	3/8"	22"	38353-02200
1/2"	3/8"	3/8"	23"	38353-02300
1/2"	3/8"	3/8"	24"	38353-02400
1/2"	3/8"	3/8"	26"	38353-02600
1/2"	3/8"	3/8"	28-3/8"	38353-02837
1/2"	3/8"	3/8"	30"	38353-03000
1/2"	3/8"	3/8"	32"	38353-03200
1/2"	3/8"	3/8"	34-3/8"	38353-03437
1/2"	3/8"	3/8"	36"	38353-03600
1/2"	3/8"	3/8"	41-1/8"	38353-04112
1/2"	3/8"	3/8"	44"	38353-04400
1/2"	3/8"	3/8"	46"	38353-04600
1/2"	3/8"	3/8"	48"	38353-04800
1/2"	3/8"	3/8"	60"	38353-06000
1/2"	3/8"	3/8"	72"	38353-07200

*Includes 3/8" A.B.S. to 3/8" male pipe adapter.

**Air chamber hose assemblies can also be made using Eaton Weatherhead EC038 hose, 33808P-106 and 33808P-Y76 hose ends, and 1390x6x6 adapter.

Hose Assembly I.D.	Male pipe	Air brake swivel*	Length L	Factory made assembly Part number**
3/8"	1/4"	3/8"	18-1/8"	38166-01812
3/8"	1/4"	3/8"	20-3/8"	38166-02137
3/8"	1/4"	3/8"	22"	38166-02200
3/8"	1/4"	3/8"	24-1/8"	38166-02412
3/8"	1/4"	3/8"	24-7/8"	38166-02487
3/8"	1/4"	3/8"	26"	38166-02600
3/8"	1/4"	3/8"	27-5/8"	38166-02762
3/8"	1/4"	3/8"	28-3/8"	38166-02837
3/8"	1/4"	3/8"	29-1/8"	38166-02912
3/8"	1/4"	3/8"	30-1/8"	38166-03012
3/8"	1/4"	3/8"	32"	38166-03200
3/8"	1/4"	3/8"	34"	38166-03400
3/8"	1/4"	3/8"	34-3/8"	38166-03437
3/8"	1/4"	3/8"	36-1/8"	38166-03612
3/8"	1/4"	3/8"	38-1/8"	38166-03812
3/8"	1/4"	3/8"	40"	38166-04000
3/8"	1/4"	3/8"	41-1/8"	38166-04112
3/8"	1/4"	3/8"	42"	38166-04200
3/8"	1/4"	3/8"	48"	38166-04800
3/8"	1/4"	3/8"	60"	38166-06000
3/8"	1/4"	3/8"	72"	38166-07200

*Includes 3/8" A.B.S. to 3/8" male pipe adapter.

**Air chamber hose assemblies can also be made using Eaton Weatherhead EC038 hose, 33808P-106 and 33808P-Y76 hose ends, and 1390x6x6 adapter.

Hose Assembly I.D.	Male pipe	Air brake swivel*	Length L	Factory made assembly Part number**
3/8"	3/8"	3/8"	18"	38097-01800
3/8"	3/8"	3/8"	20"	38097-02000
3/8"	3/8"	3/8"	24"	38097-02400
3/8"	3/8"	3/8"	26"	38097-02600
3/8"	3/8"	3/8"	28"	38097-02800
3/8"	3/8"	3/8"	30"	38097-03000
3/8"	3/8"	3/8"	32"	38097-03200
3/8"	3/8"	3/8"	34"	38097-03400
3/8"	3/8"	3/8"	40"	38097-04000
3/8"	3/8"	3/8"	42"	38097-04200
3/8"	3/8"	3/8"	60"	38097-06000
3/8"	3/8"	3/8"	72"	38097-07200

*Includes 3/8" A.B.S. to 3/8" male pipe adapter.

**Air chamber hose assemblies can also be made using Eaton Weatherhead EC038 hose, 33808P-106 and 33808P-Y76 hose ends, and 1390x6x6 adapter.

Accessories

Ready-made hose assemblies

K

Automobile, light truck gas/oil lines

Maximum working pressure

50 psi

Temperature range

-40°F to +257°F

Weatherhead H057 Hose

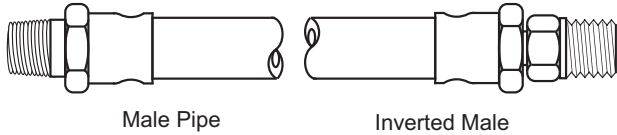

Part number	Overall length	Fitting description
11461	10"	1/8" Male pipe x 1/4" Inv. Male
11462	12"	1/8" Male pipe x 1/4" Inv. Male
11463	13"	1/8" Male pipe x 1/4" Inv. Male
11464	15"	1/8" Male pipe x 1/4" Inv. Male
11465	21"	1/8" Male pipe x 1/4" Inv. Male
11466	28"	1/8" Male pipe x 1/4" Inv. Male
11474	19"	1/8" Male pipe x 1/4" Inv. Male
11477	17"	1/8" Male pipe x 1/4" Inv. Male
11478	24"	1/8" Male pipe x 1/4" Inv. Male

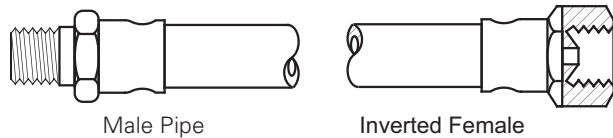

Part number	Overall length	Fitting description
11079	6-5/8"	1/8" Male pipe x 5/16" Inv. Female
11076	8-1/4"	1/8" Male pipe x 5/16" Inv. Female
11205	8-7/8"	1/8" Male pipe x 5/16" Inv. Female
11215	9-3/8"	1/8" Male pipe x 5/16" Inv. Female
11093	18"	1/8" Male pipe x 5/16" Inv. Female
11217	7-1/2"	1/4" Male pipe x 3/8" Inv. Female
11216	9"	1/4" Male pipe x 3/8" Inv. Female

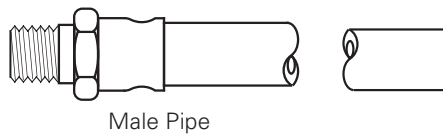

Part number	Overall length	Fitting description
11223	15-1/4"	1/4" Male pipe (one end only, other end blank)

Automobile, light truck gas/oil lines*

Maximum working pressure

50 psi

Temperature range

-40°F to +257°F

Weatherhead H057 Hose

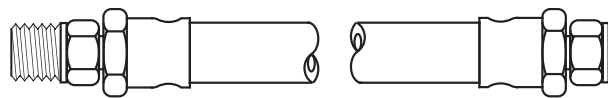

Inverted Male

Inverted Male

Part number	Overall length	Fitting description
11486	10"	1/4" Inv. Male x 1/4" Inv. Male

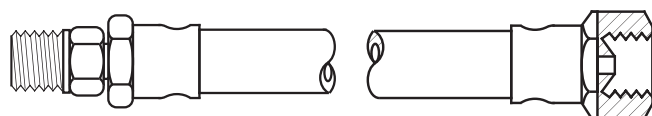

Inverted Male

Inverted Female

Part number	Overall length	Fitting inverted description
11080	5"	1/4" Male x 1/4" Female
11224	7"	1/4" Male x 1/4" Female
11089	10-5/8"	1/4" Male x 1/4" Female
11078	7"	5/16" Male x 5/16" Female
11212	7-7/8"	5/16" Male x 5/16" Female
11041	9"	5/16" Male x 5/16" Female
11208	10-3/4"	5/16" Male x 5/16" Female
11219	6-1/4"	5/16" Male x 5/16" Female

Automobile, light truck universal-type filter lines*

(1/4" SAE Swivel Nut to 1/8" Male Pipe)

Maximum operating pressure

400 psi

Operating temperature range

-40°F to +250°F

Weatherhead H05804 Hose



Note: Hose end material is brass.

*Hose assemblies listed are for automobile or light truck (up to 3/4-ton pickup truck) application only. Consult Eaton prior to any other use.

Part number	Overall length	Part number	Overall length
81430-08	8"	81430-20	20"
81430-10	10"	81430-22	22"
81430-12	12"	81430-24	24"
81430-14	14"	81430-28	28"
81430-16	16"	81430-30	30"
81430-18	18"	81430-36	36"

WARNING: California Proposition 65, see page A-2.

Accessories

Hose assembly

K

Hose insertion gauges

FF90308



Improve hose assembly reliability with these easy to use aluminum gauges that are designed to ensure proper fitting depth during pre-assembly.

Simply bottom the hose in the appropriately marked cavity and scribe a mark on the hose flush with the top surface of the gauge. Insert the fitting until the back of the socket is aligned with scribe line.

Part number	Usage
FF90308-01	For use with all hoses that mate with -4 through -16 Z-series fittings
FF90308-02	For use with all hoses that mate with -20, -24, -32 Z-series fittings
FF90308-04	For use with all hoses that mate with -06, -08, -10, -12, -16 spiral 4S/6S fittings
FF90308-05	For use with all hoses that mate with -20, -24, -32 spiral 4S/6S fittings

Pressure gauge kit

FF14802



Kit FF14802 Component Part numbers	Description	Quantity Per Kit
FF14783	1/8" NPT Test Coupling	2
FF14784	1/4" NPT Test Coupling	2
FF14787	7/16-20 UNF Test Coupling	1
FF14788	9/16-20 UNF Test Coupling	1
FF14794	1/4" NPT Gauge Adapter	3
FF14796	Union Adapter	2
FF14798	60" Test Hose Assembly	2
FF14799	(-) 30 in/Hg - 30 psi Gauge	1
FF14800	1,000 psi Gauge	1
FF14801	7,500 psi Gauge	1

Hose spacers

HSM-48



Hose spacers keep hoses organized and prevents hose abrasion at the points of contact.

Part number	Description
HSM-48	Case of 48 mixed hose spacers

Features

- Prevents damage from unrestrained hoses
- Available in 4 sizes – 3/4", 1", 1-1/8", 1-3/8"
- Packed in colorful counter display boxes of 48 – cable ties included
- Also available in mixed boxes of 48 (12 each size) or refill bags of 12

Hose protectors

HP4, HP6, HP8 and HPM



*Hose protectors available in black, orange or yellow.

Easy installation in minutes – no need to remove hose, formulated to resist solvents, oils, grease and gasoline.

Part number	Description
HP4*	4" Hose Protector Case of 50
HP6*	6" Hose Protector Case of 50
HP8*	8" Hose Protector Case of 50
HPM*	Mixed Hose Protectors Case of 60

Features

- Operating temperature range is -40° to 430°F
- Exceptionally cost effective
- Packed in easy to assemble, colorful, counter display box – cable ties included
- Available in 3 sizes: 4", 6" and 8"

Abrasion protection for

- Hydraulic hose
- Battery cables
- Wiring harness
- Brake systems
- Fuel lines
- Air lines
- Radiator hose
- Oil lines

Market applications:

- Farming
- Industrial
- Trucking
- Mining
- Construction
- Public transportation
- Aviation support
- Road maintenance
- Waste management
- Original equipment manufacturer

Accessories

Hose protection

K

Flaretite seals



The ideal product to enhance new installations of SAE 37° connections, as well as seal off minor leaks and weeping connections. Available sizes: -04 through -32.

Features

- Ribbed insert design
- Coated with Loctite sealant
- Economical method to reduce minor leaks and weeping connections
- Built-in clip to attach the Flaretite seal to the nose of the SAE 37° connection

Benefits

- Multiple surface contact points
- Locks the joint and fills surface imperfections
- Saves time & money associated with maintenance and rework
- Quick & easy assembly

Seal size	Package part number	Number of seals per package
-04	FF13267	100
-06	FF13268	100
-08	FF13269	100
-10	FF13270	100
-12	FF13271	100
-16	FF13272	50
-20	FF13273	50
-24	FF13570	25
-32	FF13571	10

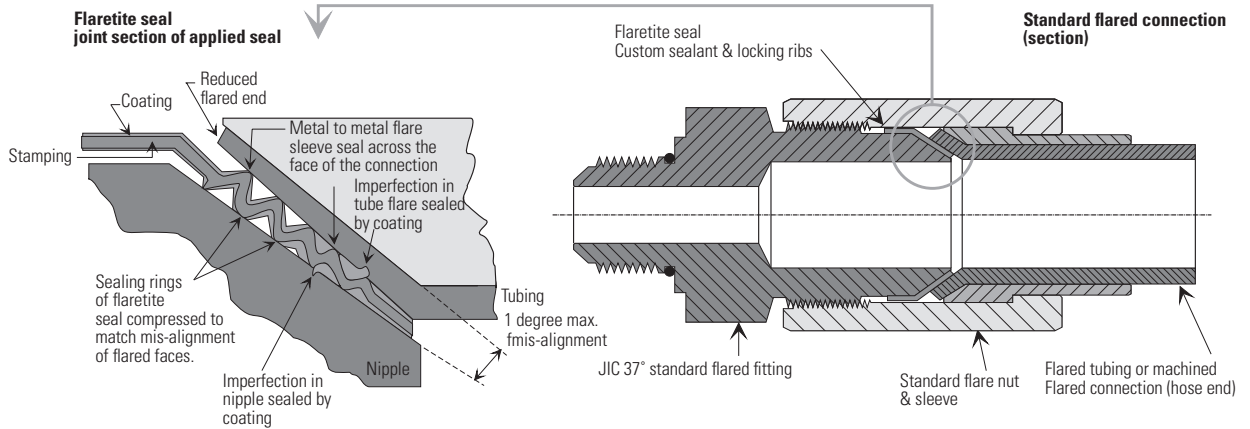

Assembly and torque requirements

To assemble an SAE 37° connection using a Flaretite seal, simply push the Flaretite seal onto the male portion of the connection. The built-in clip will hold the Flaretite seal onto the male half.

During assembly ensure:

- The seal is fitted squarely to the conical nose of the JIC fitting -37° flare.
- The sealing faces of the flared connector part are clean and free of burrs.
- The flared joint is correctly tightened with recommended torque settings noted below.

Recommended torque settings:

Tolerance: +10% -0%

-04 (1/4")	SAE 37°: 14lb-ft.	-10 (5/8")	SAE 37°: 80lb-ft.	-20 (1-1/4")	SAE 37°: 190lb-ft.
-06 (3/8")	SAE 37°: 26lb-ft.	-12 (3/4")	SAE 37°: 110lb-ft.	-24 (1-1/2")	SAE 37°: 220lb-ft.
-08 (1/2")	SAE 37°: 55lb-ft.	-16 (1")	SAE 37°: 140lb-ft.	-32 (2")	SAE 37°: 325lb-ft.

* Flaretite is a registered trademark of Flaretite Inc.
 All photos and the name Flaretite are the property of Flaretite Inc.
 ** Loctite is a registered trademark of the Henkel Corporation.

Bundling sleeves

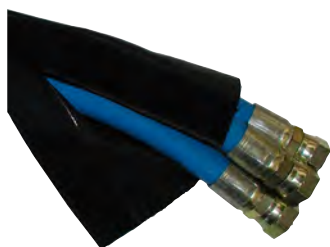

Hydraulic lines are often subjected to tremendous stress and wear during use. Lines that are allowed to move freely are easily abraded, crimped, or cut. Common methods for binding hydraulic lines, such as cable ties, can restrict movement too much as the lines expand and contract.

Bundling sleeves hold lines securely in place to protect them from damage, while providing enough flexibility for normal operation.

The sleeves can be removed and replaced quickly, allowing easy access for hose repair.

Specifications

Part number	Fits Bundle outer diameter	Circumference of Bundle to be covered (laid flat)	sleeve width	bulk roll length (ft)	length tolerance
A4926	2	6.0	7-3/4	150	(+1 ft., - 0 ft)
A4927	3	9.4	11	150	(+1 ft., - 0 ft)
A4928	4	12.5	14	150	(+1 ft., - 0 ft)
A4929	5	15.7	17-1/4	150	(+1 ft., - 0 ft)
A4930	6	18.8	20-3/8	150	(+1 ft., - 0 ft)

Construction

1050 Ballistit nylon, .71 mm thickness

Urethane coating

Color

Black

Operating temperature range

175° F

Features

- Tight bundling and secure hose containment
- Resistant to heat, ozone, and abrasion
- Easy removal and replacement

Benefits

- Increase productivity in assembly and reassembly of hose bundles
- Reduce contamination of hose during bundle assembly
- Force routing of hydraulic lines for safety and efficiency
- Reduce risk of hose bursts, resulting in greater operator safety
- Reduce time spent on field repairs
- Replace inefficient bundling methods and line-damaging cable ties
- Eliminate cumbersome winding of spiral-formed products
- Reduce old-sock-syndrome bunching at end of bundled lines
- Eliminate line contamination during hose replacement

How to order Bundling sleeves

- Part numbers above are stocked in 150 foot shrink –wrapped bulk rolls, as rolled up and unfastened
- Orders the number of rolls needed, not footage.
- 150 foot bulk rolls are one continuous length.
- Order per foot

Accessories

Hose protection

K

Bundling straps



Bundling straps hold hose, cables, pipes, tubes, and other items securely in place. They can be removed, adjusted, and put back in place easily.

Unlike cable ties, bundling straps allow hose and tubes to expand and contract in changing conditions. Cable ties cannot be reused. Bundling straps, however, can be used again and again, with no loss of strength. Their hook-and-loop fasteners, developed for industrial applications, the safety industry, and the military, have superior sheer strength and peel compared to those used in the garment industry.

Construction

Standard Duty

1050 Ballistic nylon II webbing, .71 mm thickness with dense nylon backing

Delrin plastic fastening loop on cinch and hanging straps

Urethane coating

Heavy Duty

1000 nylon webbing, 3.18 mm thickness with dense nylon backing

Nickel-plated steel 12 L.14 fastening loop on cinch and hanging straps

Urethane coating

Color

Black

Operating temperature range

-40° to +250° F

Cinching strap (CS Series) bundling straps are designed for economical service applications, such as hose and cable bundling. All joints are ultrasonically welded and tested.

Hanging strap (HS Series) bundling straps are held in place by a 3/8" grommet. The straps can be mounted vertically or horizontally.

Both cinching and hanging straps are available in standard duty or heavy duty. Heavy-duty bundling straps are designed for severe industrial applications and ultrasonically welded to 1-1/2" hook-and-loop material. All heavy-duty hardware is nickel-plated steel.

Bundling straps are sold in packages of five, and discounts are offered for volume quantities of 50, 100, 250, 500, and 1,000. Special sizes, materials, colors, and configurations are available. Ordering information on next page.

Features

- Easy to remove and replace
- Adjustable to any size bundle
- Industrial strength strap fabric and fasteners
- Secure containment of hose, cables, and other items
- Clean professional appearance

Benefits

- Reduce cost of managing cables and hose
- Improve worker safety and productivity
- Reduce abrasion of bundles items
- Save money through reusability

Merchandising kits for Bundling straps



Standard duty kit

Part Number **FF13502**

Heavy duty kit

Part Number **FF13503**

Kit contains

Each merchandising kit comes with a quantity of individually cellophane-wrapped bundling straps in both cinch and hanging styles for bundling diameters of 8", 12", 16", and 20 inches. Resupply the merchandising kit by ordering the individually wrapped straps listed on the next page.

The box has a pop-up lid that can be positioned upright, making an effective advertising backdrop. Attached to the merchandising box is a handy bundling strap for demonstration purposes.

Note: Kit boxes are stocked with approximately half the available strap capacity to allow for lower kit pricing at startup.

Bundling straps

(continued)



Cinch straps

Bulk packed or
Individually wrapped



Hanging straps

Bulk packed or
Individually wrapped



Cinch straps

Standard duty

Standard duty		Heavy duty		Circumference of hose bundle	Strap length (flat)	Ordering measurement
Bulk packed	Individually cellophane wrapped	Bulk packed	Individually cellophane wrapped			
Part number	Part number	Part number	Part number			
FF90519-4	FF90520-4	FF90521-4	FF90522-4	4"	7-3/4"	Each
FF90519-6	FF90520-6	FF90521-6	FF90522-6	6"	11"	Each
FF90519-8	FF90520-8	FF90521-8	FF90522-8	8"	14"	Each
FF90519-10	FF90520-10	FF90521-10	FF90522-10	10"	17-1/4"	Each
FF90519-12	FF90520-12	FF90521-12	FF90522-12	12"	20-3/8"	Each
FF90519-14	FF90520-14	FF90521-14	FF90522-14	14"		Each
FF90519-16	FF90520-16	FF90521-16	FF90522-16	16"		Each
FF90519-18	FF90520-18	FF90521-18	FF90522-18	18"		Each
FF90519-20	FF90520-20	FF90521-20	FF90522-20	20"		Each
	FF90520-22	FF90521-22		22"		Each
	FF90520-24	FF90521-24		24"		Each
	FF90520-26	FF90521-26		26"		Each

Hanging straps

Standard duty

Standard duty		Heavy duty		Circumference of hose bundle	Strap length (flat)	Ordering measurement
Bulk packed	Individually cellophane wrapped	Bulk packed	Individually cellophane wrapped			
Part number	Part number	Part number	Part number			
FF90523-4	FF90524-4	FF90525-4	FF90526-4	4"	7-3/4"	Each
FF90523-6	FF90524-6	FF90525-6	FF90526-6	6"	11"	Each
FF90523-8	FF90524-8	FF90525-8	FF90526-8	8"	14"	Each
FF90523-10	FF90524-10	FF90525-10	FF90526-10	10"	17-1/4"	Each
FF90523-12	FF90524-12	FF90525-12	FF90526-12	12"	20-3/8"	Each
FF90523-14	FF90524-14	FF90525-14	FF90526-14	14"		Each
FF90523-16	FF90524-16	FF90525-16	FF90526-16	16"		Each
FF90523-18	FF90524-18	FF90525-18	FF90526-18	18"		Each
FF90523-20	FF90524-20	FF90525-20	FF90526-20	20"		Each
		FF90525-22	FF90526-22	22"		Each
		FF90525-24	FF90526-24	24"		Each
		FF90525-26	FF90526-26	26"		Each

WARNING: Do not use this product for overhead lifting, support of human weight or athletic equipment, or other situations where personal safety or valuable property can be endangered.

Accessories

Hose clamps

K

Round-wire clamps

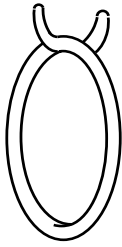

Clamp size	Hose size	Part number	Minimum diameter	Maximum diameter	Nominal diameter
06	1/4	1538	.370	.380	.375
08	5/16	1539	.551	.573	.562
10	3/8	1540	.610	.640	.625

Construction

Carbon steel spring wire,
Zinc-plated

Application

- Industrial
- Automotive
- Agriculture
- General market applications

E.F.I. Hose clamps

Electronic fuel injection hose clamps

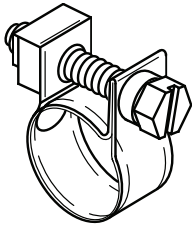

Clamp size	Part number	Minimum diameter	Maximum diameter	Nominal diameter
04	6207-004	.433	.551	.512
05	6207-005	.472	.590	.551
06	6207-006	.551	.669	.630

Construction

Plated carbon steel
23/64" (9mm) band width

FF90311

Heavy-duty hose support clamps



Heavy-duty weld-based clamps are designed to securely hold hose in applications subject to impulsing, flexing, and vibrating conditions.

The clamps help prevent abrasion and extend hose life through proper routing. Clamps are rated to ambient temperature of +250°F.

Part number	Inside Diameter	
	(mm)	(in)
FF90311-127	12.70	0.50
FF90311-137	13.70	0.54
FF90311-150	15.00	0.59
FF90311-160	16.00	0.63
FF90311-171	17.10	0.67
FF90311-174	17.40	0.69
FF90311-190	19.00	0.75
FF90311-205	20.50	0.81
FF90311-222	22.20	0.87
FF90311-239	23.90	0.94
FF90311-254	25.40	1.00
FF90311-266	26.60	1.05
FF90311-280	28.00	1.10
FF90311-300	30.00	1.18
FF90311-320	32.00	1.26
FF90311-334	33.40	1.31
FF90311-357	35.70	1.41
FF90311-381	38.10	1.50
FF90311-400	40.00	1.57
FF90311-422	42.20	1.66
FF90311-445	44.50	1.75
FF90311-483	48.30	1.90
FF90311-508	50.80	2.00
FF90311-572	57.20	2.25
FF90311-635	63.50	2.50
FF90311-700	70.00	2.76

Partial Stainless steel clamps

Full-sized and Micro-sized clamps SAE J1508 Type F

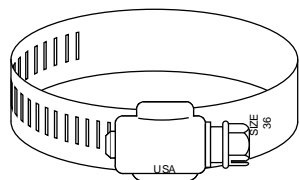

Partial stainless steel clamps utilize a 300 Series stainless steel band and housing with a steel case-hardened, zinc-plated screw. They feature a 14.3mm (9/16") band housing with a 8mm (5/16") hexagon and screwdriver slotted screw.

Application

- Heavy-duty equipment
- Agriculture
- General industry

Clamp size	Part number	Minimum diameter	Maximum diameter	Nominal diameter
*004	6205-004	7/32	5/8	1/4
*006	6205-006	5/16	7/8	1/2
006	6203-006	3/8	7/8	1/2
008	6203-008	7/16	1	9/16
010	6203-010	9/16	1-1/16	5/8
012	6203-012	9/16	1-1/4	3/4
016	6203-016	11/16	1-1/2	1
020	6203-020	3/4	1-3/4	1-1/4
024	6203-024	1-1/16	2	1-1/2
028	6203-028	1-5/16	2-1/4	1-3/4
032	6203-032	1-9/16	2-1/2	2
036	6203-036	1-13/16	2-3/4	2-1/4
040	6203-040	2-1/16	3	2-1/2
044	6203-044	2-5/16	3-1/4	2-3/4
048	6203-048	2-9/16	3-1/2	3
052	6203-052	2-13/16	3-3/4	3-1/4
056	6203-056	3-1/16	4	3-1/2
064	6203-064	3-9/16	4-1/2	4
072	6203-072	4-1/16	5	4-1/2
080	6203-080	4-5/8	5-1/2	5
088	6203-088	4-3/32	6	5-1/2
096	6203-096	4-1/2	6-1/2	6
104	6203-104	5	7	6-1/2

*Micro-sized clamps

All Stainless steel clamps

Full-sized and Micro-sized clamps SAE J1508 Type F

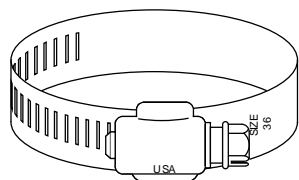

Clamps with an all stainless steel construction offers maximum protection against corrosion.

Full-sized all stainless clamps have a 14.3mm (9/16") band and housing manufactured with 300 Series stainless steel. The 8mm (5/16") hexagon and screwdriver slotted screw.

Micro-sized all stainless clamps have a 5/16" (8mm) band and housing manufactured with 300 Series stainless steel. The 6.35mm (1/4") hexagon and screwdriver slotted screw features 410 stainless steel.

Application

- Chemical
- Marine
- Food processing
- Dairy
- Automotive
- Electrical
- Plumbing

Clamp size	Part number	Minimum diameter	Maximum diameter	Nominal diameter
*004	6206-004	7/32	5/8	1/4
*006	6206-006	5/16	7/8	1/2
006	6204-006	3/8	7/8	1/2
008	6204-008	7/16	1	9/16
010	6204-010	9/16	1-1/16	5/8
012	6204-012	9/16	1-1/4	3/4
016	6204-016	11/16	1-1/2	1
020	6204-020	3/4	1-3/4	1-1/4
024	6204-024	1-1/16	2	1-1/2
028	6204-028	1-5/16	2-1/4	1-3/4
032	6204-032	1-9/16	2-1/2	2
036	6204-036	1-13/16	2-3/4	2-1/4
040	6204-040	2-1/16	3	2-1/2
044	6204-044	2-5/16	3-1/4	2-3/4
048	6204-048	2-9/16	3-1/2	3
052	6204-052	2-13/16	3-3/4	3-1/4
056	6204-056	3-1/16	4	3-1/2
064	6204-064	3-9/16	4-1/2	4
072	6204-072	4-1/16	5	4-1/2
080	6204-080	4-5/8	5-1/2	5
088	6204-088	4-3/32	6	5-1/2
096	6204-096	4-1/2	6-1/2	6
104	6204-104	5	7	6-1/2

*Micro-sized clamps

Assembly equipment

Hose assembly machines and tooling

Crimp machine comparison chart	L-2
Portable crimp machines	
ET1187	L-4
ET1000	L-6
General purpose crimp machines	
FT1380	L-8
T-420	L-10
FT1390	L-12
ET4001	L-15
Industrial production crimp machines	
ET5050	L-17
Specialty tooling packages	L-20
Repair and replacement items	L-22
Field attachable	L-25
Coll-O-Crimp pumps	L-27
Conversion tooling	L-31

Hose preparation

Saw products	L-32
Hose cutting equipment	L-36
Presetting tools and hose insertion gauges	L-37
Hose bore cleaning brushes	L-38
Hose proof test stands	L-39

Contamination control products

FT1455 projectile cleaning system	L-40
FT1455 & FT1355 nozzles and cleaning projectiles	L-46
FT1355 cleaning projectiles	L-49
FT1555 CapSeal system	L-53

Cabinets and assortments

Cabinets	L-57
Assortments	L-59
Bags	L-67
Labels	L-68



Assembly equipment

Hose assembly machines and tooling

L

Core crimp machines

With the Eaton-branded core crimp machine portfolio, all customers have access to the same crimp machines and tooling. This simplified and improved offering includes lower cost options as well as both positive stop and variable machines to meet all of your application needs. Compare our new offering of crimp machines and their associated features to understand which crimper is best for you.



Crimp machine comparison chart

	ET1187	ET1000	FT1380	T-420
Production volume	Low	Low	Medium	Medium
Type	Variable	Positive stop	Variable	Positive stop
Capability-braided (up to)	1 ¼"	1"	1 ¼"	1 ¼"
Capability-spiral (up to)	1"	1"	1 ¼"	1 ¼"
Capability-industrial (up to)	1 ¼"	1"	1 ¼"	1 ¼"
Application	Portable, job shops, maintenance departments	Portable, job shops, maintenance departments	Hose distributors, small assembly shops	Hose distributors, small assembly shops, factory, construction, mines
*Pump options	110v, air/hydraulic, 12v, hand pump	110v, air/hydraulic, 12v, hand pump	115v, 230v	110v, 220v

*Capabilities based on Eaton core hose and fitting products

*See pump ordering options for each machine for specific kit numbers

Core crimp machines



Crimp machine comparison chart

FT1390

ET4001

ET5050

Production volume	Medium/high	Medium	High
Type	Variable	Positive stop	Variable
Capability-braided (up to)	2"	2"	2"
Capability-spiral (up to)	2"	2"	2"
Capability-industrial (up to)	2"	2"	6"
Application	Hose distributors, assembly shops	Hose distributors, assembly shops, construction, mines	Industrial production facility, specialty
*Pump options	115v, 230v	220v	230v, 380v, 400v, 420v, 440v, 460v, 480v

*Capabilities based on Eaton core hose and fitting products

*See pump ordering options for each machine for specific kit numbers

Assembly equipment

Hose assembly machines and tooling

Portable crimp machines

ET1187

The ET1187 machine is our most economical variable crimp machine to date. It boasts a broad crimp capability with a new “ease-of-use” that is sure to excite hose assemblers in the field.

This machine is designed to easily adjust to Eaton’s core products. It’s as simple as turning the collar to the correct color to match the layline on the hose, adjust the ring so that the correct size dot aligns with the correct size line on the collar and the machine is set for the correct crimp. Load the correct crimp die based on the crimp die chart attached to the machine, and the machine is ready to crimp.



Specifications

Dimensions:
22” high x 9” wide x 11” deep

Weight: 65 lbs

Available with bench and truck mount brackets



Bench mount **Truck mount**

Capabilities

Braided hose: -4 thru -20

Spiral hose: -6 thru -16

Features

- Can be mounted on service vehicles or bench tops
- Can be used remotely, 65lbs
- Can be powered with virtually any 10,000 psi hydraulic power source (minimum of 36 cu. inch pump reservoir capacity is required)
- Utilizes existing FT1380 dies

Benefits

- Color-coded collar for core hose products makes setup fast and easy
- Easily transported between job sites
- Versatile power source options
- Lower investment cost than other variable crimpers
- Comes with high efficiency PTFE grease



GH681 / H180



GH781 / H280

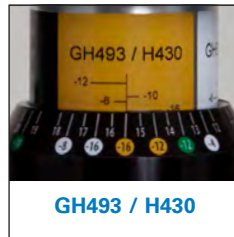

GH493 / H430

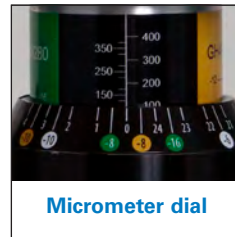

Micrometer dial

Tooling options

Die cage part #	Tooling			Tooling packages	
	1 wire braid Z/Winner	2 wire braid Z/Winner	Spiral hose 4S fitting	ET4020TP-0002	ET4020TP-0003
FT1380-200-M150	-4	-4		X	X
FT1380-200-M180	-6	-4†		X	X
FT1380-200-M210	-8	-6	-6	X	X
FT1380-200-M240	-10	-8	-8††	X	X
FT1381-200-M280	-12	-10, -12†	-8, -10	X	X
FT1380-200-M320		-12	-12	X	X
FT1380-200-M370	-16	-16		X	X
FT1380-200-M420			-16		X
FT1382-200-M465	-20	-20			X

†Die cage used to crimp Winner hose with two piece Winner fitting

††Die cage used to crimp Winner hose with 4S fitting

Note: Visit the Eaton PowerSource Crimp Specs tool at www.eatonpowersource.com/crimp-specs/ to find the tooling needed for all of the hoses and fittings you plan to crimp

Portable crimp machines

ET1187

Crimp machine part numbers

ET1187-001 Bench mount machine, no pump, no tooling (includes bracket)—for premium hose GH681/H180, GH781/H280, GH493/H430

ET1187-002 Truck mount machine, no pump, no tooling (includes bracket)—for premium hose GH681/H180, GH781/H280, GH493/H430

ET1187-003 Bench mount machine, no pump, no tooling (includes bracket)—for Winner hose EC115, EC215, EC415

ET1187-004 Truck mount machine, no pump, no tooling (includes bracket)—for Winner hose EC115, EC215, EC415

ET1187C-0017 Bench mount bracket (separate)

ET1187C-0019 Truck mount bracket (separate)

*Pump part numbers

ET1000PK-001 2-Stage hand pump

ET1000PK-002 Air/hydraulic pump

ET1000PK-003 110v electric pump

ET1000PK-004 12v DC electric pump

*These pump kits include the pump, connecting hose assembly, and all of the adapters necessary to connect the pump to the ET1187 crimp machine

Accessory part numbers

T-400-G 1.5 oz. tube, high efficiency PTFE grease

FF91455 16 oz. can, high efficiency PTFE grease

ET1187C-0008PR Replacement barrel for the ET1187-001 or ET1187-002 machine (for premium hose GH681/H180, GH781/H280, GH493/H430)

ET1187C-0008WR Replacement barrel for the ET1187-003 or ET1187-004 machine (for Winner hose EC115, EC215, EC415)

ET1187C-0009PR Replacement knob for the ET1187-001 or ET1187-002 machine (for premium hose GH681/H180, GH781/H280, GH493/H430)

ET1187C-0009WR Replacement knob for the ET1187-003 or ET1187-004 machine (for Winner hose EC115, EC215, EC415)

Ordering options

Place your order for the desired machine, pump, and tooling separately, following the chart below.

Tooling can also be ordered a la carte.

Visit the Eaton PowerSource Crimp Specs tool at www.eatonpowersource.com/crimp-specs/ to find the tooling needed for all of the hoses and fittings you plan to crimp.

Select your base machine	Select your pump kit	Select your tooling package
ET1187-001 Base machine with bench mount only	ET1000PK-003 110v pump kit	ET4020TP-0002
ET1187-002 Base machine with truck mount only	ET1000PK-002 A/H pump kit	ET4020TP-0003
ET1187-003 Base machine with bench mount only (for Winner hose EC115, EC215, EC415)	ET1000PK-004 12v pump kit	
ET1187-004 Base machine with truck mount only (for Winner hose EC115, EC215, EC415)	ET1000PK-001 Hand pump kit	

Note: All available pump kits shown include hose assembly and are CSA compliant

Assembly equipment

Hose assembly machines and tooling

Portable crimp machines

ET1000

The portable ET1000 crimp machine boasts a broad crimp capability with an ease-of-use that is sure to please hose assemblers. With four pump options—air/hydraulic, hand, 110v, or 12v DC—this portable machine can travel to the worksite. The machine comes equipped with a stand pre-drilled for mounting to a workbench or table-top.



Tooling options

Tooling	Tooling capabilities			Tooling packages		
	Die cage part #	1 wire braid	2 wire braid	Spiral hose 4S	*ET1000TP-1002 New placement package	*ET1000TP-1001 Conversion package
ET313DC-4Z	-4	-4			X	X
ET313DC-5Z	-5	-5				
ET313DC-6Z	-6	-6			X	X
ET313DC-8Z	-8	-8			X	X
ET313DC-10Z	-10	-10				
ET1000DC-12Z	-12	-12			X	X
ET1000DC-16Z	-16	-16			X	X
ET313DC-4S6			-6			
ET313DC-4S8			-8	X		X
ET313DC-4S10			-10			
ET1000DC-4S12			-12	X		X
ET1000DC-4S16			-16	X		X

*ET1000TP-1002 includes the following spacer rings—ET425SR-150A, ET313SR-090A, ET313SR-030D

*ET1000TP-1002 includes pusher extension—ET1000C-0012

*ET1000TP-1002 includes adapter ring—ET1000AR-001

*ET1000TP-1001 includes the following spacer rings—ET425SR-150A, ET313SR-090A

Note: Visit the Eaton PowerSource Crimp Specs tool at www.eatonpowersource.com/crimp-specs/ to find the tooling needed for all of the hoses and fittings you plan to crimp

Specifications

Dimensions:

22" high x 16" wide x 14" deep

Weight:

70 lbs

Allows for work bench or table top mounting

Capabilities

Braided hose: -4 thru -16

Spiral hose: -6 thru -16

Features

- Portable, positive stop, economical
- Can be mounted on service vehicles
- Utilizes 2-piece collet assemblies
- Spacer rings control the crimp diameter

Benefits

- Sliding pusher allows for easier fitting insertion into the machine
- Simple positive-stop crimp diameter control system for consistent crimping time after time with no operator adjustments required
- Easily transported between job sites
- Versatile power source options
- Electricity is required only when using an electric pump
- Comes with high efficiency PTFE grease

Portable crimp machines

ET1000

Crimp machine part numbers

ET1000-001 Base machine

Crimp machine and tooling package part numbers

ET1000-020 Contains ET1000 crimper, 110v pump kit, and ET1000TP-1002 tooling package

ET1000-021 Contains ET1000 crimper, air/hydraulic pump kit, and ET1000TP-1002 tooling package

*Pump part numbers

ET1000PK-001 Hand pump

ET1000PK-002 Air/hydraulic pump

ET1000PK-003 110 volt electric pump

ET1000PK-004 12 volt DC electric pump

*Pump kits contain hose assembly and fittings to attach pump to machine

Accessory part numbers

T-400-G 1.5 oz. tube high efficiency PTFE grease

FF91455 16 oz. can, high efficiency PTFE grease

ET1000 Ordering options

For your convenience, we have created one to two optimized machine and tooling package options for each of the core crimp machines. **If the available options do not meet your needs, place your order for the desired machine, pump, and tooling separately,** following the chart below.

Tooling can also be ordered a la carte. Visit the Eaton PowerSource Crimp Specs tool at www.eatonpowersource.com/crimp-specs/ to find the tooling needed for all of the hoses and fittings you plan to crimp.

Select your base machine	Select your pump kit	Select your tooling package	Order a machine package with tooling
ET1000-001 Base ET1000 Machine	ET1000PK-003 110v pump kit	ET1000TP-1002 New placement tooling package	ET1000-020
	ET1000PK-002 A/H pump kit	ET1000TP-1001 Conversion tooling package	ET1000-021
	ET1000PK-004 12v pump kit		
	ET1000PK-001 Hand pump kit		

or

Note: All available pump kits shown include hose assembly and are CSA compliant

Assembly equipment

Hose assembly machines and tooling

General purpose crimp machines

FT1380

The FT1380 crimp machine from Eaton crimps all your hose needs up to and including -20 spiral wire hose. The FT1380 is electronically controlled to give fast, accurate crimps the first time and every time you need a hose assembly. The electronic keypad is easy to adjust, with up to 10 programmable crimp settings. For hose styles and sizes used less frequently, simply enter the 3 digit code of that hose.



Tooling options

Tooling	Tooling capabilities			Tooling packages	
	1 wire braid Z/Winner	2 wire braid Z/Winner	Spiral hose 4S fitting	ET4020TP-0002	ET4020TP-0003
FT1380-200-M150	-4	-4		X	X
FT1380-200-M180	-6	-4 [†]		X	X
FT1380-200-M210	-8	-6	-6	X	X
FT1380-200-M240	-10	-8	-8 ^{††}	X	X
FT1381-200-M280	-12	-10,-12 [†]	-8,-10	X	X
FT1380-200-M320		-12	-12	X	X
FT1380-200-M370	-16	-16		X	X
FT1380-200-M420			-16		X
FT1382-200-M465	-20	-20	-20		X

[†]Die cage used to crimp designated hose diameter with two piece Winner fitting

^{††}Die cage used to crimp Winner hose with 4S fitting

Note: Visit the Eaton PowerSource Crimp Specs tool at www.eatonpowersource.com/crimp-specs/ to find the tooling needed for all of the hoses and fittings you plan to crimp

Crimp machine part numbers

FT1380-115 Base machine with 115v pump

FT1380-115CSA Base machine with 115v pump, CSA approved

FT1380-230 Base machine with 230v pump

FT1380-230CSA Base machine with 230v pump, CSA approved

Crimp machine and tooling package part numbers

FT1380-115-8 Contains FT1380 crimper, 115v pump, and ET4020TP-0003 tooling package

Pump part numbers

All pumps are included with machine purchase. To review machine and pump package options please refer to the ordering options on the following page.

Specifications

Dimensions:

28.5" high x 12.75" wide x 25.75" deep

Weight: 238 lbs

Allows for work bench or table top mounting

Capabilities

Braided hose: -4 thru -20

Spiral hose: -6 thru -20

Features

- User-friendly operation to minimize training and mistakes
- Pre-set crimp settings and simple die cage insertion reduce setup time
- Electronic controls for minimal maintenance
- Upright design for easy hose insertion
- Compact design that requires little space

Benefits

- Easy and quick to electronically enter crimp settings
- Can pre-program 10 most popular crimp settings
- Die cages easily slip in and out of machine
- Machine capable of swaging thermoplastic hose and hose fittings
- Comes with high efficiency PTFE grease

General purpose crimp machines

FT1380

Accessory part numbers

FT1380-2-4 Optional die holder kit—kit includes 4 die holder plates each of which will hold 2 die cages. Holes are pre-drilled on base of FT1380 machine to accept these 4 plates.

FT1380-4 Optional fitting backstop—kit includes backstop and 5/32" hex wrench. The backstop allows the FT1380 to crimp PTFE hose and to be utilized for a fitting locator to increase efficiency.

FT1330-XL Z fitting locators

FT1380-XL 4S fitting locators

T-400-G 1.5 oz. tube high efficiency PTFE grease

FF91455 16 oz. can, high efficiency PTFE grease

FT1380-2-9 Die cage repair kits for FT1380-200-size, FT1380-275-size

Ordering options

For your convenience, we have created one to two optimized machine and tooling package options for each of the core crimp machines. **If the available options do not meet your needs, place your order for the desired machine, pump, and tooling separately,** following the chart below.

Tooling can also be ordered a la carte. Visit the Eaton PowerSource Crimp Specs tool at www.eatonpowersource.com/crimp-specs/ to find the tooling needed for all of the hoses and fittings you plan to crimp.

Select your base machine	Pump included	Select your tooling package	Order a machine package with tooling:
FT1380-115 Base machine with 115v pump	115v pump included	ET4020TP-0003	FT1380-115-8
FT1380-115CSA Base machine with 115v pump, CSA approved	115v pump included	ET4020TP-0002	
FT1380-230 Base machine with 230v pump	230v pump included		
FT1380-230CSA Base machine with 230v pump, CSA approved	230v pump included		

Note: Consider an alternative positive stop machine when crimping large quantities of -20 90 degree fittings

Specialty crimp die cages

Tooling	Tooling capabilities	
Die cage part #	Hose size	Hose style
FT1380-275-M070	-03	PTFE
FT1380-275-M090	-03 Synflex, -04, -05 PTFE	Synflex, PTFE
FT1380-275-M120	-04 Synflex, -06 PTFE	Synflex, PTFE
FT1382-275-M370	-16	Two-piece Winner
FT1382-275-M520	-20	6S
*FT1380-275-R5-04	-04	Truck and fuel 100R5
*FT1380-275-R5-05	-05	Truck and fuel 100R5
*FT1380-275-R5-06	-06	Truck and fuel 100R5
*FT1380-275-R5-08	-08	Truck and fuel 100R5
*FT1380-275-R5-10	-10	Truck and fuel 100R5
*FT1380-275-R5-12	-12	Truck and fuel 100R5
*FT1380-275-R5-16	-16	Truck and fuel 100R5
*FT1380-275-R5-20	-20	Truck and fuel 100R5

*Tooling above for use with Weatherhead hose and fittings

Assembly equipment

Hose assembly machines and tooling

General purpose crimp machines

T-420



The T-420 is a versatile machine ideal for your shop, factory, construction, and mine locations. Large capacity combined with lever-activated crimping gives you wide coverage and a quick and simple way to make factory-quality hose assemblies.

Tooling options

Tooling	Tooling capabilities			Tooling packages	
Die cage part #	1 wire braid	2 wire braid	Spiral hose 4S	T420TP-1001	*T420TP-1002 (for Winner hose with Z fittings)
ET425DC-4Z	-4	-4		X	X
ET425DC-5Z	-5	-5			
ET425DC-6Z	-6	-6		X	X
ET425DC-8Z	-8	-8		X	X
ET425DC-10Z	-10	-10			
ET425DC-12Z	-12	-12		X	X
ET425DC-16Z	-16	-16		X	X
ET425DC-20Z	-20	-20			X
ET425DC-4S6			-6		X
ET425DC-4S8			-8	X	X
ET425DC-4S10			-10		
ET425DC-4S12			-12	X	X
ET425DC-4S16			-16	X	X
ET425DC-4S20			-20	X	X

*T-420-26 die ring included with base machine

*T420TP-1001 includes spacer ring ET425SR-105A

*T420TP-1001 includes adapter ring ET425AR-14

*T420TP-1002 includes adapter ring ET425AR-14

*T420TP-1002 includes the following spacer rings—ET425SR-075A, ET425SR-030D, ET425SR-015A, ET425SR-060D, ET425SR-030A, ET425SR-045A, ET425SR-015D, ET425SR-060A, ET425SR-165A, ET425SR-105A, ET425SR-090A

Note: Visit the Eaton PowerSource Crimp Specs tool at www.eatonpowersource.com/crimp-specs/ to find the tooling needed for all of the hoses and fittings you plan to crimp

Specifications

Dimensions:

22" high x 10" wide x 20-1/2" deep

Weight: 210 lbs

Bench and C-40X cabinet mounting options

Capabilities

Braided hose: -4 thru -20

Spiral hose: -6 thru -20

Features

- Positive stop, economical
- Can be mounted on a bench or the C-40X cabinet
- Utilizes 2-piece collet assemblies
- Spacer rings control the crimp diameter

Benefits

- Simple positive-stop crimp diameter control system for consistent crimping time after time with no operator adjustments required
- Versatile power source options
- Comes with high efficiency PTFE grease

General purpose crimp machines

T-420

Crimp machine part numbers

T-420-1 Base T-420 machine

T-420-1CSA Base T-420 machine, CSA approved

Crimp machine and tooling package part numbers

T-420-001 Contains T-420 crimper, 220v pump kit, T420TP-1001 tooling package

T-420-002 Contains T-420 crimper, 110v pump kit, T420TP-1001 tooling package

T-420-001CSA Contains T-420 crimper, 220v pump kit, T420TP-1001 tooling package, CSA approved

T-420-002CSA Contains T-420 crimper, 110v pump kit, T420TP-1001 tooling package, CSA approved

Pump part numbers

ET420-007 110 volt electric pump

ET420-007CSA 110 volt electric pump, CSA approved

ET420-008 220 volt electric pump

ET420-008CSA 220 volt electric pump, CSA approved

Accessory part numbers

T-400-G 1.5 oz. tube high efficiency PTFE grease

FF91455 16 oz. can, high efficiency PTFE grease

Ordering options

For your convenience, we have created one to two optimized machine and tooling package options for each of the core crimp machines. **If the available options do not meet your needs, place your order for the desired machine, pump, and tooling separately,** following the chart below.

Tooling can also be ordered a la carte. Visit the Eaton PowerSource Crimp Specs tool at www.eatonpowersource.com/crimp-specs/ to find the tooling needed for all of the hoses and fittings you plan to crimp.

Select your base machine	Select your pump kit	Select your tooling package	Order a machine package with tooling
T-420-1 Base T-420 machine	ET420-007 110v pump	T420TP-1001	T-420-001
T-420-1CSA Base T-420 machine, CSA approved	ET420-007CSA 110v pump, CSA approved	T420TP-1002 (for Winner hose with Z fittings)	T-420-002
	ET420-008 220v pump		T-420-001CSA
	ET420-008CSA 220v pump, CSA approved		T-420-002CSA

or

Assembly equipment

Hose assembly machines and tooling

General purpose crimp machines

FT1390

The FT1390 crimp machine is a stand-alone machine and will crimp up to 2" braided, 2" four spiral, and 2" six spiral hydraulic hose assemblies. It boasts a programmable electronic keypad with 10 presets.

This keypad simplifies the hose crimping operation by allowing the machine operator to enter a predetermined setting for a specific hose type and size. The ten most often used crimp settings can be stored for one-touch retrieval. The machine will automatically crimp to the exact crimp diameter required for that hose type and size. The electronic crimp machine settings eliminate the need for spacers or shims in the crimping operation.



Tooling options

Tooling	Tooling capabilities				Tooling packages		
	Die cage part #	1 wire braid	2 wire braid	Spiral hose 4S	Spiral hose 6S	ET4040TP-0007	ET4040TP-0008
FT1307-200-M150	-4	-4				X	
FT1307-200-M180	-6					X	
FT1307-200-M210	-8	-6	-6			X	
FT1307-200-M240	-10	-8				X	
FT1307-200-M280	-12	-10, -12†	-8, -10			X	
FT1307-200-M320		-12				X	
FT1307-200-M370	-16	-16				X	
FT1307-200-M420	-20		-16			X	
FT1307-200-M465	-20	-20				X	
FT1307-200-M520	-24					X	
FT1307-200-M550	-32††	-24				X	
FT1307-200-M690	-32	-32				X	
FT1209-200-82			-12			X	
FT1209-200-15		-24†					
FT1209-200-46		-20†					
*FT1390-200-14			-20				X
*FT1390-200-20			-24				X
*FT1390-200-23			-32				X
*FT1390-200-15				-20			
*FT1390-200-16				-24			
*FT1390-200-21				-32			

*Die cages are hinged for ease of use when crimping large elbows

†Die cage used to crimp designated hose diameter with two piece Winner fitting

Note: Two piece Winner fitting not qualified with -32 core hose products (used with EC110-32 and GH506-32)

Note: Visit the Eaton PowerSource Crimp Specs tool at www.eatonpowersource.com/crimp-specs/ to find the tooling needed for all of the hoses and fittings you plan to crimp

Specifications

Dimensions:

49" high, 29" wide, 28" deep

Weight: 825 lbs

Capabilities

Braided hose: -4 thru -32

Spiral hose: -6 thru -32

Features

- Front-end loading design
- Electronic keypad control of crimp diameter
- Power return stroke, return limit control
- Drop-in tooling (crimp die cages)
- Backstop fitting locator
- Worklamp equipped

Benefits

- Easy and quick to electronically enter crimp setting
- Can pre-program 10 most popular crimp settings
- Die cages easily slip in and out of machine
- Comes with high efficiency PTFE grease

General purpose crimp machines

FT1390

Crimp machine part numbers

FT1390-115 Base machine with 115v pump

FT1390-115CSA Base machine with 115v pump, CSA approved

FT1390-230 Base machine with 230v pump

FT1390-230CSA Base machine with 230v pump, CSA approved

Crimp machine and tooling package part numbers

FT1390-115-12 Contains FT1390 crimper with 115v pump, and ET4020TP-0007 tooling package

Pump part numbers

All pumps are included with machine purchase. To review machine and pump package options please refer to the ordering options below.

Accessory part numbers

T-400-G 1.5 oz. tube high efficiency PTFE grease

FF91455 16 oz. can, high efficiency PTFE grease

Ordering options

For your convenience, we have created one to two optimized machine and tooling package options for each of the core crimp machines. **If the available options do not meet your needs, place your order for the desired machine, pump, and tooling separately,** following the chart below.

Tooling can also be ordered a la carte. Visit the Eaton PowerSource Crimp Specs tool at www.eatonpowersource.com/crimp-specs/to find the tooling needed for all of the hoses and fittings you plan to crimp.

Select your base machine	Pump included	Select your tooling package	Order a machine package with tooling
FT1390-115 Base machine with 115v pump	FT1390-115 115v pump included	ET4040TP-0007	FT1390-115-12
FT1390-115CSA Base machine with 115v pump, CSA approved	FT1390-115CSA 115v pump included	ET4040TP-0008	
FT1390-230 Base machine with 230v pump	FT1390-230 230v pump included		
FT1390-230CSA Base machine with 230v pump, CSA approved	FT1390-230CSA 230v pump included		

or

Assembly equipment

Hose assembly machines and tooling

L

General purpose crimp machines

FT1390

Specialty crimp die cages

Tooling	Tooling capabilities	
Die cage part #	Hose size	Hose style
FT1209-200-14	-20	4S
FT1209-200-15	-20	6S
FT1209-200-16	-24	6S
FT1209-200-20	-24	4S
FT1209-200-21	-32	6S
FT1209-200-23	-32	4S
FT1307-200-M070	-03 PTFE	PTFE
FT1307-200-M090	-03 Synflex, -04, -05 PTFE	Synflex, PTFE
FT1307-200-M120	-04 Synflex, -06 PTFE	Synflex, PTFE

Note: Additional dies and die cage assemblies also available. Refer to website or contact Eaton

Note: FT1209-200-size & FT1390-200-size are for use with internal skive and 4S/6S fittings (SAE100R11 & SAE100R13 hose styles).

Note: FT1390-200-size dies cages are hinged to allow ease of use when crimping large elbows

Barrel crimp die cages

Die cage part #	Hose size	Hose style
FT1307-200-R5-04	-04	Truck and fuel 100R5
FT1307-200-R5-05	-05	Truck and fuel 100R5
FT1307-200-R5-06	-06	Truck and fuel 100R5
FT1307-200-R5-08	-08	Truck and fuel 100R5
FT1307-200-R5-10	-10	Truck and fuel 100R5
FT1307-200-R5-12	-12	Truck and fuel 100R5
FT1307-200-R5-16	-16	Truck and fuel 100R5
FT1307-200-R5-20	-20	Truck and fuel 100R5
FT1307-200-R5-24	-24	Truck and fuel 100R5
FT1307-200-R5-32	-32	Truck and fuel 100R5
*FT1392-200-R5-24	-24	Truck and fuel 100R5
*FT1392-200-R5-32	-32	Truck and fuel 100R5

*Hinged die cage

Note: Tooling above for use with Weatherhead hose and fittings

Die cage repair kits

Die cage part #	Order
FT1307-200-size	FT1307-2-9
FT1390-200-size	FT1390-2-9
FT1209-200-size	FT1209-2-9

We're changing the crimping game.

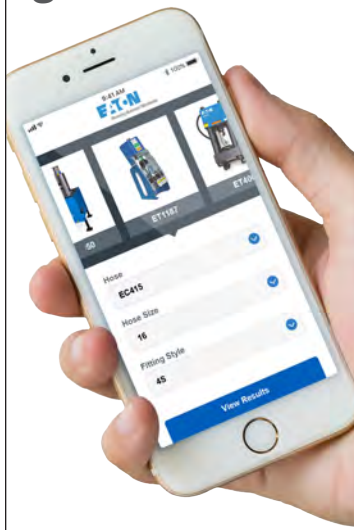

Now on Mobile.

eatonpowersource.com/
crimp-specs

General purpose crimp machines

ET4001

The ET4001 is ideal for factory, high-performance machine operations, construction and mine locations. This machine offers the capabilities of crimping all of the crimp-style hose ends through -32. With this coverage, this heavy-duty crimper can handle all of your crimping needs.



Tooling options

Tooling	Tooling capabilities				Tooling packages			
	Die cage part #	1 wire braid	2 wire braid	Spiral hose 4S	Spiral hose 6S	*ET4001TP-1002 new placement package	*ET4001TP-1001 conversion package	*ET4001TP-1003 (for Winner hose with Z fittings)
ET525DC-4Z	-4	-4				X	X	X
ET525DC-5Z	-5	-5						X
ET525DC-6Z	-6	-6			X	X	X	X
ET525DC-8Z	-8	-8			X	X		X
ET525DC-10Z	-10	-10						X
ET525DC-12Z	-12	-12			X	X		X
ET525DC-16Z	-16	-16			X	X		X
ET525DC-20Z	-20	-20						X
ET525DC-24Z	-24	-24						X
ET525DC-32Z	-32	-32						
ET525DC-4S6			-6					X
ET525DC-4S8			-8		X	X		X
ET525DC-4S10			-10					
ET525DC-4S12			-12		X	X		X
ET525DC-4S16			-16		X	X		X
ET525DC-4S20			-20		X	X		X
ET575DC-4S24			-24		X	X		X
ET575DC-4S32			-32		X	X		X
ET525DC-6S20				-20				
ET575DC-6S24				-24				
ET575DC-6S32				-32				

*ET4000AR-001 adapter ring included with base machine

*ET4001TP-1002 includes the following spacer rings—ET575SR-135A, ET525SR-120A, ET525SR-180A, ET525SR-225A, ET525SR-240A

*ET4001TP-1002 includes adapter ring ET4000AR-002

*ET4001TP-1001 includes the following spacer rings—ET575SR-135A, ET525SR-120A

*ET4001TP-1003 includes the following spacer rings—ET525SR-030A, ET575SR-120A, ET575SR-015A, ET525SR-075A, ET525SR-015A, ET525SR-180A, ET525SR-090A, ET525SR-075D, ET525SR-045A, ET525SR-240A, ET525SR-015D, ET525SR-060A, ET525SR-195A, ET525SR-120A, ET525SR-105A

Note: Visit the Eaton PowerSource Crimp Specs tool at www.eatonpowersource.com/crimp-specs/ to find the tooling needed for all of the hoses and fittings you plan to crimp

Specifications

Dimensions:

29" high, 12" wide, 21" deep

Weight:

550 lbs

Bench or Work Table Mounting

Capabilities

Braided Hose: -4 thru -32

Spiral Hose: -6 thru -32

Features

- Shop / work table mount, positive stop
- Features a two-stage pump providing high flow at low pressure for fast ram approach and low flow at high pressure for actual crimping

Benefits

- Ideal for factory, construction and mine locations
- Crimps up to 2" 6 wire spiral hose
- Comes with high efficiency PTFE grease

Assembly equipment

Hose assembly machines and tooling

General purpose crimp machines

ET4001

Crimp machine part numbers

ET4001-004 Base ET4001 machine with hose kit, pump, work lamp

ET4001-004CSA Base ET4001 machine with hose kit, pump, work lamp, CSA approved

Pump part numbers

ET4001P-002 220v single phase electric pump

T-410-22 36" pump to press hose assembly

ET4001P-002CSA 220v single phase electric pump, CSA approved

Crimp machine and tooling package part numbers

ET4001-015 Contains ET4001 crimper, 220v pump kit, and ET4001TP-1002 tooling package

ET4001-015CSA Contains ET4001 crimper, 220v pump kit, and ET4001TP-1002 tooling package, CSA approved

Accessory part numbers

T-400-G 1.5 oz. tube high efficiency PTFE grease

FF91455 16 oz. can, high efficiency PTFE grease

ET4001C-0017 Magnetic work lamp

Ordering options

For your convenience, we have created one to two optimized machine and tooling package options for each of the core crimp machines. **If the available options do not meet your needs, place your order for the desired machine, pump, and tooling separately,** following the chart below.

Tooling can also be ordered a la carte. Visit the Eaton PowerSource Crimp Specs tool at www.eatonpowersource.com/crimp-specs/ to find the tooling needed for all of the hoses and fittings you plan to crimp.

Select your base machine	Pump included	Select your tooling package	Order a machine package with tooling
ET4001-004 Base ET4001 machine with hose kit, pump, work lamp	ET4001-004 220v pump included	ET4001TP-1002 New placement tooling package	ET4001-015
ET4001-004CSA Base ET4001 machine with hose kit, pump, work lamp, CSA approved	ET4001-004CSA 220v pump included	ET4001TP-1003 (for Winner hose with Z fittings)	ET4001-015CSA
		ET4001TP-1001 Conversion tooling package	

or

Industrial production crimp machines

ET5050

The ET5050 is designed for high industrial production and comes pre-programmed with all of Eaton's hose and hose fitting crimp specifications, crimp profile details, and machine settings in order to crimp to Eaton's specifications. It crimps up to 2" spiral, 2" braided and 4" industrial in Eaton core hose products as well as a wide variety of specialty hose.

Tooling packages: standard die

Standard die set part #	Die size		Die length		Minimum		Crimp range maximum	
	mm	in	mm	in	mm	in	mm	in
ET5040DC-M070S	7,0	0.276	82,0	3.23	7,0	0.28	9,0	0.35
ET5040DC-M090S	9,0	0.354	82,0	3.23	9,0	0.35	12,0	0.47
ET5040DC-M120S	12,0	0.472	82,0	3.23	12,0	0.47	15,0	0.59
*ET5040DC-M150S	15,0	0.590	82,0	3.23	15,0	0.59	18,0	0.71
*ET5040DC-M180S	18,0	0.709	82,0	3.23	18,0	0.71	21,0	0.83
*ET5040DC-M210S	21,0	0.827	82,0	3.23	21,0	0.83	24,0	0.95
*ET5040DC-M240S	24,0	0.945	82,0	3.23	24,0	0.95	28,0	1.10
*ET5040 DC-M280S	28,0	1.102	82,0	3.23	28,0	1.10	32,0	1.26
ET5040DC-M320S†	32,0	1.259	82,0	3.23	32,0	1.26	37,0	1.46
ET5040DC-M355S	35,5	1.398	82,0	3.23	35,5	1.40	39,5	1.56
*ET5040DC-M370S	37,0	1.457	82,0	3.23	37,0	1.46	42,0	1.66
*ET5040DC-M420S	42,0	1.654	82,0	3.23	42,0	1.66	46,5	1.83
ET5040DC-M450S	45,0	1.772	82,0	3.23	45,0	1.77	50,0	1.97
*ET5040DC-M465S	46,5	1.831	82,0	3.23	46,5	1.83	52,0	2.05
ET5040DC-M505S	50,5	1.988	82,0	3.23	50,5	1.99	54,0	2.13
*ET5040DC-M520S	52,0	2.047	82,0	3.23	52,0	2.05	55,0	2.17
*ET5040DC-M550S	55,0	2.165	82,0	3.23	55,0	2.17	60,0	2.36
ET5040DC-M570S	57,0	2.244	82,0	3.23	57,0	2.24	64,0	2.52
ET5040DC-M590S	59,0	2.323	82,0	3.23	59,0	2.32	66,0	2.60
ET5040DC-M620S	62,0	2.441	82,0	3.23	62,0	2.44	70,0	2.76
*ET5040DC-M690S	69,0	2.717	82,0	3.23	69,0	2.72	73,0	2.87
ET5040DC-M720S	72,0	2.835	82,0	3.23	72,0	2.84	78,0	3.07
ET5040DC-M775S	77,5	3.051	82,0	3.23	77,5	3.05	85,5	3.37
ET5040DC-M790S	79,0	3.110	82,0	3.23	79,0	3.11	88,0	3.46

*Included in the ET5040C-0023 standard die kit

†Supplied with all ET5040 crimp machines and required for calibration

ET5040C-0001 adapter die required for all M series dies and comes standard in each KT machine package.



Specifications

Dimensions:

67" high x 24" wide x 48" deep

Weight: 1,851 lbs (without mounting rack and dies)

Capabilities

Spiral hose: up to 2" (DN51)

Braided hose: up to 3" (DN80)

Industrial hose: up to 6" (DN102)

Features

- 280 tons of crimp force
- Designed for high production
- Pre-programmed with Eaton crimp specs and machine settings
- Crimps up to 2" spiral, 2" braided, 6" industrial in core products
- Crimps textile braid, wire braid, spiral hydraulic, thermoplastic, PTFE, air conditioning, and other industrial and specialty hose constructions

Benefits

- Ease of use and fast cycle times increase productivity
- Pre-loaded Eaton crimp specs reduce errors and scrap
- Fast and safe crimp operation
- Grease free dies allow for much easier and cleaner die changeout and reduce chance for operator error due to not having to apply grease to dies and crimp ring
- Convenient die storage rack allows easy access to crimp dies and tooling

Assembly equipment

Hose assembly machines and tooling

Industrial production crimp machines

ET5050

Tooling: large bore die

Standard die set part #	Die size		Die length		Minimum		Crimp range maximum	
	mm	in	mm	in	mm	in	mm	in
ET5040PBL-M740	74,0	2.913	118,0	4.65	74,0	2.92	83,0	3.26
ET5040PBL-M780	78,0	3.070	118,0	4.65	78,0	3.07	86,0	3.38
ET5040PBL-M840	84,0	3.307	118,0	4.65	84,0	3.31	92,0	3.62
ET5040PBL-M860	86,0	3.386	118,0	4.65	86,0	3.39	94,0	3.70
ET5040PBL-M900	90,0	3.543	118,0	4.65	90,0	3.55	99,0	3.89
ET5040PBL-M960	96,0	3.800	118,0	4.65	96,0	3.80	105,0	4.13
ET5040PBL-M1030	103,0	4.055	118,0	4.65	103,0	4.06	113,0	4.44
ET5040PBL-M1060	106,0	4.173	126,0	4.96	106,0	4.18	116,0	4.56
ET5040PBL-M1110	110,0	4.331	126,0	4.96	110,0	4.33	121,0	4.76
ET5040PBL-M1160	116,0	4.567	126,0	4.96	116,0	4.57	127,0	4.99
ET5040PBL-M1210	121,0	4.764	126,0	4.96	121,0	4.77	133,0	5.23
ET5040PBL-M1260	126,0	4.961	126,0	4.96	126,0	4.96	138,0	5.43
ET5040PBL-M1310	131,0	5.157	126,0	4.96	131,0	5.16	144,0	5.66

Note: Each set includes 8 individual dies

100R5 dies for the ET5050

Die part #	Hose size	Hose style
ET5040DC-R5-04	-04	Truck and fuel 100R5
ET5040DC-R5-05	-05	Truck and fuel 100R5
ET5040DC-R5-06	-06	Truck and fuel 100R5
ET5040DC-R5-08	-08	Truck and fuel 100R5
ET5040DC-R5-10	-10	Truck and fuel 100R5
ET5040DC-R5-12	-12	Truck and fuel 100R5
ET5040DC-R5-16	-16	Truck and fuel 100R5
ET5040DC-R5-20	-20	Truck and fuel 100R5
ET5040DC-R5-24	-24	Truck and fuel 100R5
ET5040DC-R5-32	-32	Truck and fuel 100R5

Crimp machine part numbers*

ET5050-001-230KT

ET5050-001-380KT

ET5050-001-400KT

ET5050-001-420KT

ET5050-001-440KT

ET5050-001-460KT

ET5050-001-480KT

*All crimp machine part numbers come with the machine, calibration tooling, die installation tool, standard die package, adapter die package, double foot pedal and machine mounted storage rack

Industrial production crimp machines

ET5050

Pump part numbers

All pumps are included with machine purchase. To review machine and pump package options please refer to the following ordering options.



Accessory part numbers

***ET5040C-0001†** Adapter die package (Supplied with ET5050 crimp machines. Required for use with ET5040DC style dies and used to calibrate machine.)

***ET5040C-0004** Die installation tool

ET5040C-0006 Automatic backstop

ET5040C-0007 Manual backstop

ET5050C-0009 Viewing mirror

***ET5040C-0014** Machine mounted die storage rack (includes insert holders)

ET5040C-0016 Table top die storage rack (includes insert holders)

***ET5040C-0019†** Calibration tool (supplied with ET5050 crimp machines)

***ET5040C-0020** Double pedal foot switch

***ET5040C-0023** Includes 11 of the most popular standard ET5040DC style die sets

ET5040DC-M320S† 32mm die set

ET5040DC-MXXX Standard die sets

ET5040PBL-MXXX Large bore industrial hose die sets

ET4001C-0017 Magnetic work lamp

*Components included in machine kit packages "KT"

†Calibration tooling (supplied with all ET5050 base machines)

Please note that ET5050 shares dies, crimp components, and some accessories with the ET5040

Ordering options

Tooling can also be ordered a la carte. Visit the Eaton PowerSource Crimp Specs tool at www.eatonpowersource.com/crimp-specs/ to find the tooling needed for all of the hoses and fittings you plan to crimp.

Select a machine kit	Kit includes	Pump included
ET5050-001-230KT	ET5050-001-230 machine, calibration tooling, die installation tool, standard die package, adapter die package, double foot pedal and machine mounted storage rack	230v 3 phase pump included
ET5050-001-380KT	ET5050-001-380 machine, calibration tooling, die installation tool, standard die package, adapter die package, double foot pedal and machine mounted storage rack	380v 3 phase pump included
ET5050-001-400KT	ET5050-001-400 machine, calibration tooling, die installation tool, standard die package, adapter die package, double foot pedal and machine mounted storage rack	400v 3 phase pump included
ET5050-001-420KT	ET5050-001-420 machine, calibration tooling, die installation tool, standard die package, adapter die package, double foot pedal and machine mounted storage rack	420v 3 phase pump included
ET5050-001-440KT	ET5050-001-440 machine, calibration tooling, die installation tool, standard die package, adapter die package, double foot pedal and machine mounted storage rack	440v 3 phase pump included
ET5050-001-460KT	ET5050-001-460 machine, calibration tooling, die installation tool, standard die package, adapter die package, double foot pedal and machine mounted storage rack	460v 3 phase pump included
ET5050-001-480KT	ET5050-001-480 machine, calibration tooling, die installation tool, standard die package, adapter die package, double foot pedal and machine mounted storage rack	480v 3 phase pump included

Assembly equipment

Hose assembly machines and tooling



Refer to page A-2 and applicable machine operator's manuals for safety information.

L

Specialty tooling

Coll-o-crimp collet kit

The Eaton tools listed are offered in kits for any given hose type, or collets and tools can be purchased individually by catalog number.

Visit the Eaton PowerSource Crimp Specs tool at www.eatonpowersource.com/crimp-specs/ to find the tooling needed for all of the hoses and fittings you plan to crimp.



T-400-30 'E' Series collet kit

This kit can be used with the following C-O-C systems: T-400-1, T-420-1, T-440-1, ET4000, T-460, T-462, T-465, and T-480.

Spacer Rings not included in T-400-30 kit.

Kit includes one each of the following:

Catalog number	Description	Catalog number	Description
T-400-113C	Collet – 3/16" (H243 only)	T-400-34C	Collet – 1/2"
T-400-31C	Collet – 1/4"	T-400-35C	Collet – 3/4"
T-400-32C	Collet – 5/16"	T-400-36C	Collet – 1"
T-400-33C	Collet – 3/8"	FS-1200	Label set/layout guide

T-400-66 069 'E' Series collet kit

This kit can be used with the following C-O-C systems: T-400-1, T-420-1, T-440-1, ET4000, T-460, T-462, T-465, and T-480.

Spacer Rings not included in T-400-66 kit.

Kit includes one each of the following:

Catalog number	Description	Catalog number	Description
T-400-54C	Collet – 3/16"	T-400-59C	Collet – 5/8"
T-400-55C	Collet – 1/4"	T-400-60C	Collet – 7/8"
T-400-56C	Collet – 5/16"	T-400-61C	Collet – 1-1/8"
T-400-57C	Collet – 13/32"	T-400-70	Collet – 1-3/8"
T-400-58C	Collet – 1/2"	FS-1500	Label set/layout guide



Refer to page A-2 and applicable machine operator's manuals for safety information.

Specialty tooling

Coll-o-crimp collet kit

The Eaton tools listed are offered in kits for any given hose type, or collets and tools can be purchased individually by catalog number.

Visit the Eaton PowerSource Crimp Specs tool at www.eatonpowersource.com/crimp-specs/ to find the tooling needed for all of the hoses and fittings you plan to crimp.



T-400-104 338 'P' Series collet kit

This kit can be used with the following C-O-C systems: T-400-1, T-420-1, T-440-1, ET4000, T-460, T-462, T-465, and T-480.

Spacer Rings not included in T-400-104 kit.

Kit includes one each of the following:

Catalog number	Description
T-400-102C	Collet – 3/8"
T-400-103C	Collet – 1/2"

Catalog number	Description
FS-2900	Label set

T-400-114 757 'E' Series collet kit

This kit can be used with the following C-O-C systems: T-400-1, T-420-1, T-440-1, ET4000, T-460, T-462, T-465, and T-480.

Spacer Rings not included in T-400-114 kit.

Kit includes one each of the following:

Catalog number	Description
T-400-105C	Collet – 5/16"
T-400-107C	Collet – 1/2"

Catalog number	Description
T-400-106C	Collet – 13/32"
T-400-108C	Collet – 5/8"

T-400-137 229 'P' Series collet kit

This kit can be used with the following C-O-C systems: T-400-1, T-420-1, T440-1, ET4000, T460, T-462, T-465, and T-480.

Spacer Rings not included in T-400-137 kit.

Kit includes one each of the following:

Catalog number	Description
T-400-80C	Collet – 3/16"
T-400-82C	Collet – 13/32"

Catalog number	Description
T-400-81C	Collet – 5/16"
T-400-83C	Collet – 1/2"

Assembly equipment

Hose assembly machines and tooling



Refer to page A-2 and applicable machine operator's manuals for safety information.

Repair and replacement items

General repair and replacement items

Catalog number	Description
T-400-G	1.5 oz. Tube high efficiency PTFE grease
FF91455	16 oz. Can, high efficiency PTFE grease

ET1000 Repair and replacement items

Catalog number	Description
ET1000C-0001	Stand
ET1000C-0006	Pusher
ET1000AR-001	Adapter ring

ET4001 Repair and replacement items

Catalog number	Description
ET4001C-0017	Gooseneck lamp, magnetic mount
T-410-1M	Micro switch
ET4000AR-001	Base adapter ring
ET4000AR-002	Base adapter ring
ET4000TP-0001	Locator bracket kit
ET4000TP-0002	Wear plate kit
ET4001C-0015	Shroud
120-00429	Screw, hex head (8)
FF91042	Cart for ET4001 or T-420

T-420 Repair and replacement items

Catalog number	Description
T-420-1M	Micro-switch for T-420-1 press
T-420-28	Tool locator bracket
T-420-B	Pusher bolt and washers
W-EQCR-TE006-E	Shroud decal
T-420-H	Handle
T-420-L	Light bulb
T-420-LA	Light assembly
T-420-LS	Light switch
W-EQCR-TM004-E	Instructions for T-420-1
T-420-P	Pusher set (2) with wear plates and screws
T-420-S	Press shroud with decals
T-420-26	Insert – base plate
E-EQCR-ME002-E	Instructional video
T-420-G	Linkage assembly
T-420-2R	Rack
T-420-2K	Pinion shaft assembly (incl'd T-420-2G, T-420-2R and T-420-2S)
T-420-2S	Replacement pinion gear shaft
140-06745	Pusher wear plates includes (1) left and (1) right
140-06748	Pusher wear plates screws (1)
FF91042	Cart for ET4001 or T-420

See pages L-27 thru L-30 for replacement pumps.

Reference pages L-20 and L-21 for specialty tooling and collet kits. For individual tooling items, such as collets, spacer rings, machine bowls, and adapter rings, visit the Eaton PowerSource Crimp Specs tool at www.eatonpowersource.com/crimp-specs/ or contact Eaton.

Refer to page A-2 and applicable machine operator's manuals for safety information.

Additional repair and replacement items are available. Refer to the owner's manual or contact Eaton for information.

T-450/T-465 repair and replacement items

Catalog number	Description
T-450-D1	Spacer ring selector decal for nylon hose (H009, H209, H243, H435, and H436)
T-450-P	Pusher
T-450-Q	Quick disconnect coupling
T-450K	Pusher and retainer plate repair kit.
	Includes: T-450B Pusher bolt (1) T-450R Retainer plate (1) T-450S Retainer plate screw (2)
W-EQCR-TE011-E	Shroud decal

T-464 Repair and replacement items

Catalog number	Description	Catalog number	Description
W-EQCR-TM008-E	Instructions	T-460-P	Pusher
T-460-SPR	Slide pull rod	T-460-SF	Slide flange
T-460-16	Hose assembly	T-460-SP	Slide plate
T-460-2	Hand pump	T-460-SPK	Slide pull knob
W-EQCR-TE009-E	Shroud decal	E-EQCR-ME002-E	Instructional video

T-466 Repair and replacement items

Catalog number	Description	Catalog number	Description
W-EQCR-TM008-E	Instructions	T-460-SPK	Slide pull knob
T-460-P	Pusher	T-460-SPR	Slide pull rod
T-460-SF	Slide flange	T-462-16	Hose assembly
T-460-SP	Slide plate	T-462-V	Regulator only
W-EQCR-TE010-E	Shroud decal	T-462-2	Air/hydraulic pump
140-06675	Air regulator kit	E-EQCR-ME002-E	Instructional video



Refer to page A-2 and applicable machine operator's manuals for safety information.

Repair and replacement items

T-480 Portable coll-o-crip repair and replacement items

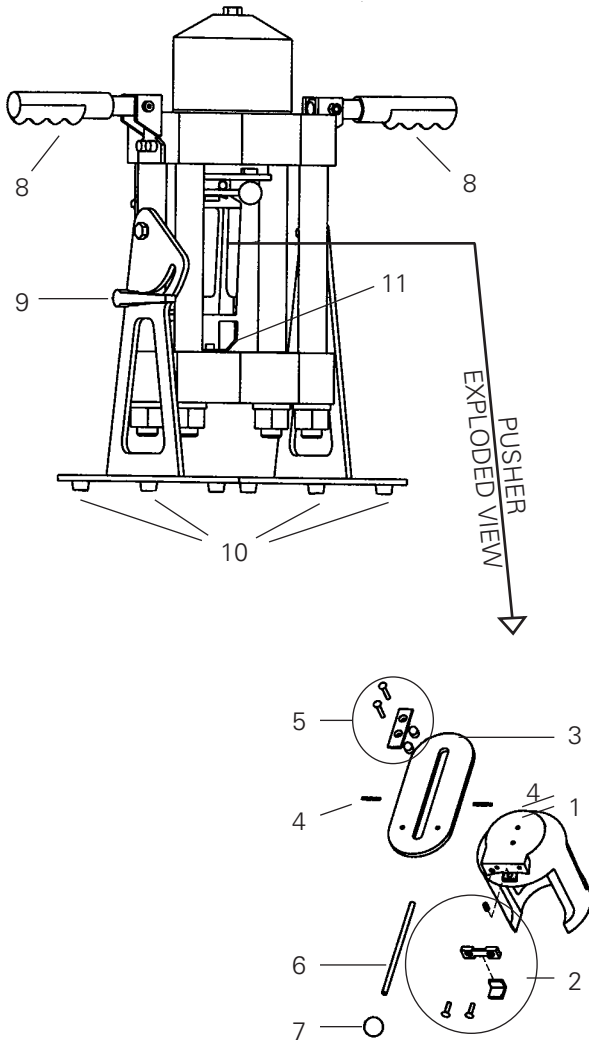

Item number	Catalog number	Description
1	T-480-P	Pusher
2	T-480-PSK	Pusher stop repair kit (Includes pusher clip, 2 machine screws, pusher stop and spring)
3	T-480-SP	Slider plate
4	140-05485-01	Roll pin
5	T-480-SFK	Slide flange kit (Includes slide flange, 2 bushings and 2 machine screws)
6	T-480-SPR	Slide pull rod
7	T-480-SPK	Slide pull knob
8	140-06601	Vinyl grip
9	T-480-TBK	Tilt bracket knob
10	140-06894	Foot pad
11	T-480-69	Tool locator bracket
#	T-480-16	10,000 PSI replacement hose assembly for 480-HP
#	T-480-17	10,000 PSI replacement hose assembly for T-480-TA and T-480-EP
#	T-480-18	10,000 PSI replacement hose assembly for 480-AH
#	140-06906	Hydraulic quick coupler used with the T-480-TA and T-480-EP system
#	T-480-3	Turbo air/hydraulic replacement pump for T-480-TA system
#	T-481-110	Electric replacement pump for T-480-EP system
#	T-480-2	Hand replacement pump for T-480-HP system
#	T-482-2	Air/hydraulic replacement pump for T-480-AH system
#	W-EQCR-TE012-E	Shroud decal
#	W-EQCR-TM013-E	Set-up and operating guide for T-480 system
#	E-EQCR-ME002-E	Instructional video

Item not illustrated in parts breakdown.

Assembly equipment

Hose assembly machines and tooling



Refer to page A-2 and applicable machine operator's manuals for safety information.

L

Repair and replacement items

T-400-1 Coll-o-crimp I repair and replacement items

Catalog number	Description
T-400-B	Pusher bolt
T-400-BB	Switch to interface T400-1 crimper to T421U pump or T-421U-110 pump
T-400-G	1.5 oz. Tube high efficiency * grease
T-400-K1	Seal replacement kit for T-400-1 press
W-EQCR-TD003-E	Shroud decal
T-400-M	Instructions for T-400-1
T-400-S	Replacement press shroud with decals.
T-400-8	Die ring
T-400-13	Replacement** collet cage for T-400 "U" Series collets, 1/4" and 3/8" sizes only, and 229 "P" series collets, all sizes, with a 'C' suffix.
T-400-14	Replacement** collet cage for T-400 "U" Series collets with a "C" suffix, 1/2" through 1" only,
T-400-19	60" Hose assembly and fittings
T-400-90	Replacement** collet cage for T-400 "E", 069 "E", and "E" Series collets with a "C" suffix.
T-432-15	Pusher
E-EQCR-ME002-E	Instructional video

** 2 required for each collet

Repair and replacement items

Hose cutting and skiving wheels



Part number	Type	Blade dia.	Hole dia.	Applicable machine
Cutting wheels				
T-1042	Carborundum	8"	5/8"	T-10A
T-1047	Steel smooth	7"	5/8"	T-10B & T-10C
T-1047-1	Steel scalloped	7"	5/8"	T-10B & T-10C
T-1060	Carborundum	12"	1"	T-60
T-1060A	Carborundum	14"	1"	T-60A
T-1070	Steel scalloped	14"	1"	T-70, T-71
T-1071	Steel scalloped toothed	14"	1"	T-70, T-71
T-1072	Steel smooth beveled	14"	1"	T-70, T-71
T-75-11	Steel smooth	10"	3/4"	T-9/T-75
T-75-14	Steel scalloped	10"	3/4"	T-9/T-75
T-75-17	Carborundum	10"	3/4"	T-9/T-75
Skiving wheels				
T-75-12	Wire	8"	1"	T-75



Refer to page A-2 and applicable machine operator's manuals for safety information.

Assembly equipment

Hose assembly machines and tooling

Field attachable

T-300

Field attachable hose end assembly machine



The Weatherhead T-300 machine eliminates lost time and hard work when making replacement hose assemblies with bulk hose and field attachable hose ends. Simple, effortless operation provides uniform, safe assemblies time after time. This heavy-duty machine assembles straight, swivel, elbow and flange-type ends on all medium and high pressure wire braid hose from 3/16" through 2" I.D.

Part number	Description
T-300	Assembly machine – complete with tripod stand, adjustable locator, chuck handle and foot switch
T-300X	Assembly machine without tripod stand
T-301	Tripod stand

Motor

Universal, reversible, 110-115 volts, 25-60 cycle, 1/2 H.P., 8 amps

Weight

167 lbs.

Mandrel Assembly tools



These tools are required for assembling 069 'D' Series hose ends in sizes 4 through 12 to prevent cutting the hose inner tube. Size 16 through 32 mandrels are used as a holding device when assembling 069 'D' Series swivel ends. Mandrels can be ordered individually.

Hose I.D.	Part number	Swivel end application
3/16"	T-JS4	SAE 37° & 45°
1/4"	T-JS5	SAE 37° & 45°
5/16"	T-J6	SAE 37°
5/16"	T-S6	SAE 45°
13/32"	T-JS8	SAE 37° & 45°
1/2"	T-JS10	SAE 37° & 45°
5/8"	T-J12	SAE 37°
5/8"	T-S12	SAE 45°

Hose I.D.	Part number	Swivel end application
7/8"	T-J16	SAE 37°
1-3/8"	T-J24	SAE 37°
1-13/16"	T-J32	SAE 37°

Assembly equipment

Hose assembly machines and tooling



Refer to page A-2 and applicable machine operator's manuals for safety information.

L

Field attachable

T-101A

Barb-Tite™ end assembly tool



Assembly of Barb-Tite push-on hose ends is made easy with this handy tool. Easy and fast operation assures dependable, leak proof assemblies. Simply clamp hose in jaws, place hose end on push rod and pull the handle. Engineered for a lifetime of rugged service.

Weight

1 lb.

Capacity

1/4" to 1/2" I.D. hose only.

T-201

Barb-Tite end assembly tool



This bench-mounted tool is actually two tools in one. Not only does it assemble Barb-Tite hose ends, it is also a hose cutter. To cut your hose, simply retract the handle, place the hose in the cutter area and pull the handle. After cutting the hose to the desired length, place the hose under the cam handle locking it in place with the hose end aligned with the appropriate mark on the label. Place the barbed end of the fitting against the end of the hose and then pull the handle forward to complete the installation. The T-201 assembly tool is an easy-to-use tool that does everything you need to create a hose assembly.

Replacement blade T-201B

Note: This tool is designed to cut fiber-reinforced rubber hose only.

Capacity

1/4" to 3/4" I.D. hose

Coll-O-Crimp pumps

T-403-2

Hand pump

For use with T-400-1.



Pump specifications:

Dimensions
7 high, 21" long, 4-3/4" wide

Weight
9 lbs.

Operation pressure
4000-4200 PSI

Reservoir capacity
1 qt.

Outlet port size
3/8"

NPT hydraulic oil
Use Enerpac oil ONLY

For repair and replacement items for the following pumps please contact an Enerpac distributor at www.enerpac.com: T-402-2, T-403-2, T-481-110 & T-482-2.

T-460-2

Hand pump

For use with T-450-1, T-460 and T-465.



Pump specifications:

Dimensions
5-5/8" High, 13-1/4" long, 3-3/4" wide

Weight
4-1/2 lbs.

Operation pressure
0-10,000 PSI

Reservoir capacity
20 cu in.

Relief valve setting
10,000 PSI

Hydraulic oil:
Use Enerpac oil ONLY

Note:
For repair and replacement items for the following pumps please contact an Enerpac Distributor at www.enerpac.com: T-402-2, T-403-2, T-433, T-460-2, T-462-2, T-480-2, T-480-3, T-481-110 & T-482-2.

T-480-2

Two-stage hand pump

For use with T-480-HP, ET1000.



Pump specifications:

Dimensions
7-3/16" high x 21-1/64" long x 4-3/4" wide

Weight
9 lbs.

Operation pressure
0-10,000 PSI

Hydraulic oil
Use Enerpac oil ONLY

Repair and replacement items for discontinued T-401-1 pump

Catalog number	Description
T-401-1BC	Breather cap for Fenner-Stone pumps
T-401-1S	Toggle switch
T-401-SVF	Shuttle valve for Fenner-Stone pump

Assembly equipment

Hose assembly machines and tooling

L

Coll-O-Crimp pumps

T-421U

Electric pump (220 volt)

For use with T-400-1 and T-420-1.



Pump specifications:

Dimensions 7-1/2" high, 22" long, 10" wide

Weight 75 lbs.

Operation pressure 4000-4200 PSI

Reservoir capacity 6 quarts

Outlet port size 3/4"-16 Straight Thread

Motor 1 H.P., 3450 R.P.M., 220 volts, 60 cycle, single phase
At 50 Hertz, RPM = 2,850
At 60 Hertz, RPM = 3,450

T-421UCSA CSA approved

Hydraulic oil* ISO 32 hydraulic oil or (ATF) automatic transmission fluid

Flow 2.5 GPM @ 750 PSI, 0.5 GPM @ 4000 PSI

*For low temperature applications automatic transmission fluid can be substituted.

Note: It is recommended that the electric pump be used on a 15 amp. fused circuit. Pump wired for 220 volts, single phase.

Replacement parts:

Catalog number	Description
140-06761	Relay for T-421U, T-441 and T-441 pumps only
T-421U-BC	Breather cap - twist lock
T-421-FP	220v 4 wire female electrical receptacle
T-401-1BC	Breather cap threaded

T-421U-110

Electric pump (110 volt)

For use with T-400-1 and T-420-1.

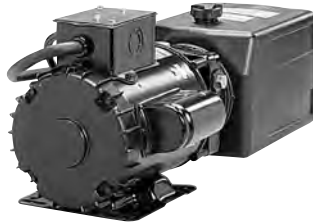

For dimensional data other than voltage information, refer to T-421U see above.

T-421U-110CSA CSA approved

Note: It is recommended that the electric pump be used on an individual 30 amp. fused circuit.

Pump wired for 110 volts, single phase.

T-481-110

Electric pump (110 volt)

For use with T-480-EP, ET1000.



Pump specifications:

Dimensions 14-14" High, 9-5/8" long, 9-5/8" wide

Weight 32 lbs.

Operation pressure 0-10,000 psi

Hydraulic oil Use Enerpac oil ONLY

ET4001P-002

Electric pump (220 volt)

For use with ET4001 press.

It features a two-stage pump providing high flow at low pressure for fast ram approach and low flow at high pressure for actual crimping.

Pump specifications:

Dimensions: 7 1/2" high, 10" wide, 22" long

Weight 75 lbs.

Operation pressure 5,000 psi

Reservoir capacity 6 quarts

Outlet port size 3/4"-16 Straight thread O-Ring

Motor 1HP, 3450 RPM, 220 volts, 60 cycle, single phase

Hydraulic oil ISO 32 (SAE 10W)

Flow 2.6 GPM to 900 psi. 0.6 GPM above 900 psi

CAUTION: The ET4001P-002 electric pump has the relief valve set at 5,000 psi. Damage to the press will result and the warranty may be voided if higher pressures are used. Requires individual 20 amp service breaker (220 v).

Coll-O-Crimp pumps

T-441

Electric pump (220 volt)

For use with T-440-1 and ET4000 only.



The Weatherhead T-441 power unit is designed for use with the Coll-O-Crimp II Plus press. It features a two-stage pump providing high flow at low pressure for fast ram approach and low flow at high pressure for actual crimping.

Pump specifications:

Dimensions: 7-1/2" high, 22" long, 10" wide

Weight 75 lbs.

Operation pressure
5,000 PSI

Reservoir capacity 6 quarts

Outlet port size
3/4-16 Straight thread O-Ring

Motor 1 H.P., 3450 R.P.M., 220 volts, 60 cycle, single phase

Hydraulic oil ISO 32 hydraulic oil automatic transmission fluid

Flow 2.5 GPM @ 750 PSI, 0.5 GPM @ 5000 PSI

Replacement parts:

Catalog number	Description
T-421U-BC	Breather cap
T-421-FP	220v 4 wire female electrical receptacle
140-06761	Relay for T-421U or T-421U-110 pumps

Note: T441 pump is to be used with T440-1 and ET4000 press only. When replacing the pump on a standard T-410 Coll-O-Crimp II Press (without the black switchbox on the side of the press) refer to the repair and replacement items on page L-22.

T-402-2

Air/hydraulic pump

For use with T-400-1.



Pump specifications:

Dimensions
5-1/4" high, 12-1/2" long, 5" wide

Weight 18 lbs.

Operation pressure
4000-4200 PSI

Reservoir capacity 1 pint

Hydraulic oil
Use Enerpac oil ONLY

Outlet port size
3/8" NPT

Inlet (air) port size
1/4" NPT

Inlet air pressure required
60 to 120 PSI

Note: It is recommended that a filter, regulator, lubricator, and air pressure gauge be installed in the air line as close as possible to the pump. Filter, regulator, and lubricator units not included.

Some models have air port on right side.

T-482-2

Air/hydraulic pump

For use with T-480-AH, ET1000.



Pump specifications:

Dimensions
5" High, 14-5/8" long, 5-5/8" wide

Weight
12 lbs.

Operation pressure
0-10,000 psi

Hydraulic oil
Use Enerpac oil ONLY

Assembly equipment

Hose assembly machines and tooling

L

Coll-O-Crimp pumps

T-462-2

Air/hydraulic pump

For use with T-462.



The Weatherhead T-462-2 power unit is a air/hydraulic pump designed for use with the T-462 portable system. Ideal if you have the availability of compressed air in your shop or in the field via a portable compressor.

Pump specifications:

Dimensions

4" high, 13" long

Weight

8 lbs.

Operation pressure

0-10,000 PSI

Reservoir capacity

10 cu in.

Relief valve setting

10,000 PSI

Hydraulic oil

Use Enerpac oil ONLY

Regulator to be set for 100-120 PSI inlet air

T-480-3

Turbo air/hydraulic pump

For use with T-480-TA.



Pump specifications:

Dimensions

8-1/4" High x 12-3/8" long x 8" wide

Weight

16-1/2 lbs.

Operation pressure

0-10,000 PSI

Hydraulic oil:

Use Enerpac oil ONLY

For repair and replacement items for the following pumps please contact an Enerpac Distributor at

www.enerpac.com:

T-402-2, T-403-2, T-460-2, T-462-2, T-480-2, T-480-3, T-481-110 & T-482-2.

T-421-FP

4-Prong female electrical outlet

All Weatherhead 220v Coll-O-Crimp power pumps are equipped with a four prong electrical outlet as illustrated.

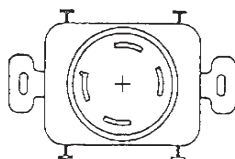

To obtain corresponding female wall receptacle order T-421-FP.

For use with T-421U, T-441 and T-433 pumps.



Refer to page A-2 and applicable machine operator's manuals for safety information.

Competitor conversion kits

T-400-GT

Gates PC707 conversion kit



The T-400-GT conversion kit is designed to allow the use of standard Weatherhead Coll-O-Crimp tooling, hose, and hose ends in the Gates PC707 crimper. Everything is included to convert the crimper to accept Weatherhead tooling. This kit gives the crimper capacity to crimp up to and including -10 I.D. 2-wire hose factory-type hose assemblies. **This kit does not include the T-400-8 die ring which is required for crimping.**

T-400-GT Kit includes:

Pusher, 10-24 x 1/4 set screws (2), spacer (2), instructions

T-400-PH

Parker 80c conversion kit



The T-400-PH conversion kit is designed to allow the use of standard Weatherhead Coll-O-Crimp tooling, hose, and hose ends in the Parker 80c crimper. Everything is included to convert the crimper to accept Weatherhead tooling. This kit gives the crimper capacity to crimp up to and including 1-1/4" I.D. 2-wire hose factory-type hose assemblies.

T-400-PH Kit includes:

1/4-20 x 1 Cap screw (4), dowel pin spacer (2), 1/4" lockwasher (4), spacer bracket (4), adapter die ring, instructions

T-420-GT

Gates PC707 conversion kit



The T-420-GT conversion kit is designed to allow the use of standard Eaton tooling, hose, and hose ends in the Gates PC707 crimper. Everything is included to convert the crimper to accept Eaton tooling. This kit gives the crimper capacity to crimp up to and including 1-1/4" I.D. 4-wire spiral hose factory-type hose assemblies. Tooling should be ordered separately.

T-420-GT Kit includes:

Shroud, adapter ring, locator pins (2), instructions

Assembly equipment

Hose preparation

Hose saws

ET9100, ET9200 & ET9300 series

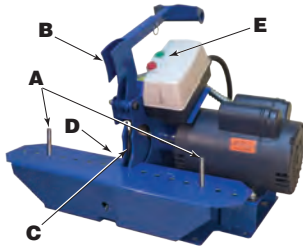

Clean cuts • less smoke • longer life

ET9100/200/300 hydraulic hose cutting system is break-through technology using a toothed blade, cutting with the backs of each tooth, so the blade does not take a kerf. The saw bends the hose into the blade spreading the cut edges to avoid burning and smoking.

How it works

With the ET9100/200/300 hydraulic hose saws the hose is positioned across two pins (A) and moved into the blade (C) by a feed foot (B) using a pulldown handle for better leverage on

heavy hose. The feed motion causes the hose to stretch at the point of contact with the blade, allowing it to separate as it is cut (see image at right). This separation allows the hose to pass clear of the saw blade with NO friction, NO heating and NO DEBRIS! A vacuum hose (not shown) is attached to a vacuum port (D) to remove any tiny amount of debris or smoke during cutting. Improved safety using a 110V on/off switch (E) with a magnetic contactor. When power is lost, the saw will not turn back on independently.

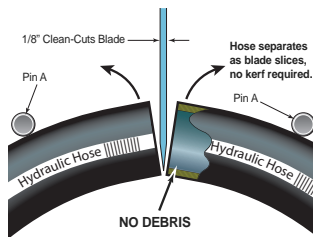

WARNING The user must exercise extreme care when operating any Eaton assembly equipment with powered moving components. Safety glasses must be worn at all times when using any Eaton assembly equipment.

Read and understand the owners and operators manual before attempting to operate any equipment.

Eaton personnel are available to answer any questions, please call Eaton, 14615 Lone Oak Road, Eden Prairie, MN 55344, 952-937-9800. Eaton assembly equipment is designed to be used only with Weatherhead and Winner hose and Eaton hose fittings.

ET9100 Series



ET9100 series saws

Model	Motor	7 inch Blade	Cutting capacity
ET9100-07-110	1-1/2 HP, 110 VAC (1 Phase), 60 Cycle, 17** Amp, 3,430 RPM	7" OD x .093 THK X 3/4" arbor	1-1/4" ID x 4 wire hydraulic hose
ET9100-07-110CSAt	1-1/2 HP, 110 VAC (1 Phase), 60 Cycle, 17** Amp, 3,430 RPM	7" OD x .093 THK X 3/4" arbor	1-1/4" ID x 4 wire hydraulic hose
ET9100-07-22060	2 HP, 220 VAC (1 Phase), 60 Cycle, 11* Amp, 3,430 RPM	7" OD x .093 THK X 3/4" arbor	1-1/4" ID x 4 wire hydraulic hose
ET9100-07-22050	2 HP, 220 VAC (1 Phase), 50 Cycle, 11* Amp, 2,865 RPM	7" OD x .093 THK X 3/4" arbor	1-1/4" ID x 4 wire hydraulic hose

* Requires 15 Amp Circuit ** Requires 20 Amp Circuit †Canadian Standards Association Rated

ET9100 series saw blades

Model	Type	Blade	Cutting capacity
ET9100-07-AS	Advanced scallop blade	7" OD x .093 THK X 3/4" arbor	1-1/4" ID x 4 wire hydraulic hose
ET9100-07-MS	Micro-slotted blade	7" OD x .093 THK X 3/4" arbor	1-1/4" ID x 4 wire hydraulic hose
ET9100-07-SM	Smooth blade	7" OD x .093 THK X 3/4" arbor	1-1/4" ID x 4 wire hydraulic hose
ET9100-07-SC	Scalloped blade	7" OD x .093 THK X 3/4" arbor	1-1/4" ID x 4 wire hydraulic hose
ET9100-07-SL	Slotted blade	7" OD x .093 THK X 3/4" arbor	1-1/4" ID x 4 wire hydraulic hose

ET9200 Series



ET9200 series saws

Model	Motor	10 inch Blade	Cutting capacity
ET9200-10-220	5 HP, 220 VAC (1 Phase), 60 Cycle, 21 Amp, 3,490 RPM	10" OD x .125 THK X 40 mm	2" ID x 6 wire hydraulic hose ‡
ET9200-10-22050	3 HP, 220 VAC (1 Phase), 50 Cycle, 4 Amp, 2,865 RPM	10" OD x .125 THK X 40 mm	2" ID x 6 wire hydraulic hose ‡
ET9200-10-220 CSA †	5 HP, 220 VAC (1 Phase), 60 Cycle, 21 Amp, 3,490 RPM	10" OD x .125 THK X 40 mm	2" ID x 6 wire hydraulic hose ‡
ET9200-10-220-3	3 HP, 220 VAC (3 Phase), 60 Cycle, 11* Amp, 3,490 RPM	10" OD x .125 THK X 40 mm	2" ID x 6 wire hydraulic hose ‡
ET9200-10-220-3 CSA †	3 HP, 220 VAC (3 Phase), 60 Cycle, 11* Amp, 3,490 RPM	10" OD x .125 THK X 40 mm	2" ID x 6 wire hydraulic hose ‡
ET9200-10-440-3	3 HP, 440 VAC (3 Phase), 60 Cycle, 4 Amp, 3,490 RPM	10" OD x .125 THK X 40 mm	2" ID x 6 wire hydraulic hose ‡
ET9200-10-12V	4 HP, 12 VDC, 10,000 RPM	10" OD x .125 THK X 40 mm	2" ID x 4 wire hydraulic hose
ET9200-10-24V	4 HP, 24 VDC, 10,000 RPM	10" OD x .125 THK X 40 mm	2" ID x 4 wire multi-spiral hydraulic hose

* Requires 15 Amp Circuit ** Requires 20 Amp Circuit
 †Canadian Standards Association Rated ‡ Diamond Blade Recommended for Frequent 6 Wire Cutting

ET9200 series saw blades

Model	Type	Blade size	Cutting capacity
ET9200C-10-AS	Advanced scallop bladew	10" OD x .125 THK X 40 mm arbor	2" ID x 6 wire hydraulic hose ‡
ET9200C-10-MS	Micro-slotted blade	10" OD x .125 THK X 40 mm arbor	2" ID x 6 wire hydraulic hose ‡
ET9200C-10-D	Diamond blade	10" OD x .125 THK X 40 mm arbor	2" ID x 6 wire hydraulic hose ‡
ET9200C-10-SM	Smooth blade	10" OD x .125 THK X 40 mm arbor	2" ID x 6 wire hydraulic hose ‡
ET9200C-10-SC	Scalloped blade	10" OD x .125 THK X 40 mm arbor	2" ID x 6 wire hydraulic hose ‡
ET9200C-10-SL	Slotted blade	10" OD x .125 THK X 40 mm arbor	2" ID x 6 wire hydraulic hose ‡

ET9300 Series



ET9300 series saws

Model	Motor	14 inch Blade	Cutting capacity
ET9300-14-220	5 HP, 220 VAC (1 Phase), 60 Cycle, 21 Amp, 3,490 RPM	14" OD x .160 THK X 40 mm	2" ID x 6 wire hydraulic hose ‡ and 5" OD spiral wound hose
ET9300-14-22050	3 HP, 220 VAC (1 Phase), 50 Cycle, 11* amp, 3,490 RPM	14" OD x .160 THK X 40 mm	2" ID x 6 wire hydraulic hose ‡ and 5" OD spiral wound hose
ET9300-14-220-3	3 HP, 220 VAC (3 Phase), 60 Cycle, 11* Amp, 3,490 RPM	14" OD x .160 THK X 40 mm	2" ID x 6 wire hydraulic hose ‡ and 5" OD spiral wound hose
ET9300-14-440-3	3 HP, 440 VAC (3 Phase), 60 Cycle, 4 Amp, 3,490 RPM	14" OD x .160 THK X 40 mm	2" ID x 6 wire hydraulic hose ‡ And 5" OD spiral wound hose
ET9300-14-220-3 CSA †	3 HP, 220 VAC (3 Phase), 60 Cycle, 11* Amp, 3,490 RPM	14" OD x .160 THK X 40 mm	2" ID x 6 wire hydraulic hose ‡ and 5" OD spiral wound hose

* Requires 15 Amp Circuit ** Requires 20 Amp Circuit
 †Canadian Standards Association Rated ‡ Diamond Blade Recommended for Frequent 6 Wire Cutting

ET9300 series saw blades

Model	Type	Blade size	Cutting capacity
ET9300C-14-AS	Advanced scallop blade	14" OD x .160 THK X 40 mm arbor	2" ID x 4 wire hydraulic hose 5" OD spiral wound hose
ET9300C-14-MS	Micro-slotted blade	14" OD x .160 THK X 40 mm arbor	2" ID x 4 wire hydraulic hose 5" OD spiral wound hose
ET9300C-14-D	Diamond blade	14" OD x .160 THK X 40 mm arbor	2" ID x 4 wire hydraulic hose 5" OD spiral wound hose
ET9300C-14-SM	Smooth blade	14" OD x .160 THK X 40 mm arbor	2" ID x 4 wire hydraulic hose 5" OD spiral wound hose
ET9300C-14-SC	Scalloped blade	14" OD x .160 THK X 40 mm arbor	2" ID x 4 wire hydraulic hose 5" OD spiral wound hose
ET9300C-14-SL	Slotted blade	14" OD x .160 THK X 40 mm arbor	2" ID x 4 wire hydraulic hose 5" OD spiral wound hose

Assembly equipment

Hose preparation

L

Hose saw blades

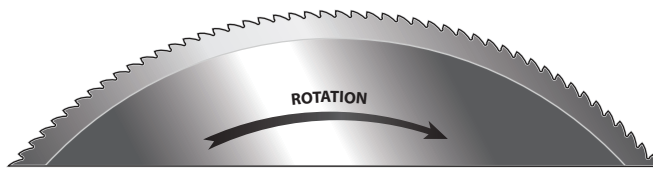

Advanced scalloped blades

Features advanced performance scalloped knife technology for cutting hydraulic spiral hose and wire helix hose resulting in cleaner cuts, faster cuts, no smoke, and longer blade life. Available in 6" to 14" sizes to fit Clean-Cuts™, Weatherhead®, Custom Crimp®, Gates®, Goodyear®, Imperial Eastman®, Parker®, Stratoflex®, Toledo®, and Weatherhead® saws.

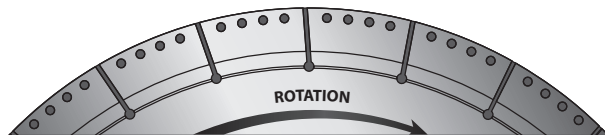

Diamond hydraulic hose blades

Exclusively designed for cutting heavy 4 and 6 wire hydraulic hoses. This diamond grinding technology cuts down by 60% the debris while cutting heavy hoses very quickly as opposed to using abrasive wheels. You will get a fantastic finish and make 5 – 10 second cuts in 2" hose.



Smooth beveled edge hydraulic hose blades

Smooth edge knife designed for the best finish when cutting light duty hoses like single wire braid, textile reinforced, poly or nylon reinforced, and Teflon hoses.

Available in sizes 6"-14" to fit Clean-Cuts™, Weatherhead®, Custom Crimp®, Gates®, Goodyear®, Hydrosand®, Imperial Eastman®, O+P®, Parker®, Savage Stone®, Stratoflex®, Toledo®, and Weatherhead®.

Advanced scalloped blade

Model	Diameter	Thickness	Arbor	Eaton saw
ET9500C-06-AS	6"	0.093"	5/8"	-
ET9500C-07-AS	7"	0.093"	5/8"	-
ET9100C-07-AS	7"	0.093"	3/4"	ET9100
ET9500C-08-AS	8"	0.093"	5/8"	-
ET9500C-10-AS	10"	0.093"	3/4"	-
ET9500C-10-1-AS	10"	0.125"	1"	-
ET9200C-10-AS	10"	0.125"	40mm	ET9200
ET9500C-12-AS	12"	0.125"	1"	-
ET9500C-14-AS	14"	0.125"	1"	-
ET9300C-14-AS	14"	0.160"	40mm	ET9300

Diamond hydraulic hose blade

Model	Diameter	Thickness	Arbor	Eaton saw
ET9200C-10-D	10"	0.125"	40mm	ET9200
ET9300C-14-D	14"	0.160"	40mm	ET9300

Smooth beveled edge hydraulic hose blade

Model	Diameter	Thickness	Arbor	Eaton saw
ET9500C-07-SM	7"	0.093"	5/8"	-
ET9100C-07-SM	7"	0.093"	3/4"	ET9100
ET9500C-08-SM	8"	0.093"	5/8"	-
ET9500C-10-SM	10"	0.062"	5/8"	-
ET9500C-10-1-SM	10"	0.093"	3/4"	-
ET9200-10-1-SM	10"	0.093"	40mm	ET9200
ET9500C-10-2-SM	10"	0.125"	1"	-
ET9200C-10-SM	10"	0.125"	40mm	-
ET9500C-12-SM	12"	0.093"	1"	-
ET9500C-12-1-SM	12"	0.125"	1"	-
ET9500C-14-SM	14"	0.125"	1"	-
ET9300C-14-SM	14"	0.160"	40mm	ET9300
ET9500C-16-SM	16"	0.160"	1"	-
ET9500C-18-SM	18"	0.160"	1"	-
ET9500C-20-SM	20"	0.160"	1"	-
ET9500C-22-SM	22"	0.160"	1"	-
ET9500C-24-SM	24"	0.160"	1"	-
ET9500C-26-SM	26"	0.160"	1"	-

Hose saw blades

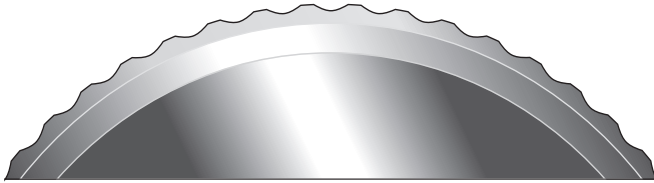

Notched scalloped hydraulic hose blades

Notched scalloped knives are designed for rough duty cutting on spiral hose up to 6 wire.

Available in sizes 6"-14" to fit Clean-Cuts™, Weatherhead®, Custom Crimp®, Gates®, Goodyear®, Hydros cand®, Imperial Eastman®, O+P®, Parker®, Savage®, Stone®, Stratoflex®, Toledo®, and Weatherhead®.

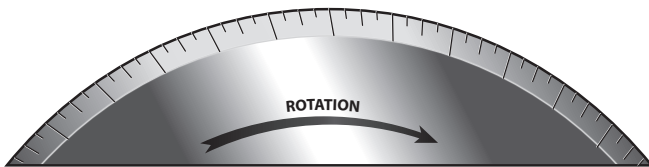

Micro-slotted smooth hydraulic hose blades

Features "new" micro-slotted smooth edge knife technology combining the better finishes of a double bevel knife with the more aggressive performance of a slotted knife. This is our most universal knife grind and will give you two times longer blade life than smooth edge knives. Used for cutting spiral hose, industrial hose, Teflon, PTFE, Kevlar, and metal hose.

Available in 6" to 14" sizes to fit Clean-Cuts™, Weatherhead®, Custom Crimp®, Gates®, Goodyear®, Imperial Eastman®, Parker®, Stratoflex®, Toledo®, and Weatherhead® saws.

Also available in 16" to 26" sizes to fit Hydros cand®, Finn Power®, Marken®, O+P®, Savage®, Stone®, Techmaf lex® and Uniflex® saws.

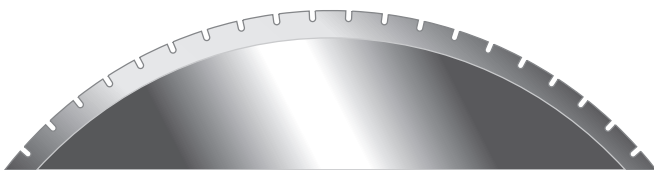

Slotted smooth hydraulic hose blades

Designed for cutting 4 to 6 wire spiral hoses, this high performance heavy duty slotted knife reduces pinching by skiving the sides of the hose while cutting.

Available in sizes 16" to 36" to fit on Finn Power®, Hydros cand®, Marken®, O+P®, Savage®, Stone®, Stratoflex®, Techmaf lex® and Uniflex® saws.

Teflon is a trademark of The Chemours Company FC, LLC used under license by Eaton.

Notched scalloped hydraulic hose blade

Model	Diameter	Thickness	Arbor	Eaton saw
ET9500C-07-SC	7"	0.093"	5/8"	-
ET9100C-07-SC	7"	0.093"	3/4"	ET9100
ET9500C-08-SC	8"	0.093"	5/8"	-
ET9500C-10-SC	10"	0.093"	3/4"	-
ET9500C-10-1-SC	10"	0.125"	1"	-
ET9200C-10-SC	10"	0.125"	40mm	ET9200
ET9500C-12-SC	12"	0.125"	1"	-
ET9500C-14-SC	14"	0.125"	1"	-

Micro-slotted smooth edge hydraulic hose blade

Model	Diameter	Thickness	Arbor	Eaton saw
ET9500C-06-MS	6"	0.093"	5/8"	-
ET9500C-07-MS	7"	0.093"	5/8"	-
ET9100C-07-MS	7"	0.093"	3/4"	ET9100
ET9500C-08-MS	8"	0.093"	5/8"	-
ET9500C-10-MS	10"	0.062"	5/8"	-
ET9500C-10-1-MS	10"	0.093"	3/4"	-
ET9200C-10-1-MS	10"	0.093"	40mm	ET9200
ET9500C-10-2-MS	10"	0.125"	1"	-
ET9200C-10-MS	10"	0.125"	40mm	ET9200
ET9500C-12-MS	12"	0.093"	1"	-
ET9500C-12-1-MS	12"	0.125"	1"	-
ET9500C-14-MS	14"	0.125"	1"	-
ET9300C-14-MS	14"	0.160"	40mm	ET9300
ET9500C-16-MS	16"	0.160"	1"	-
ET9500C-18-MS	18"	0.160"	1"	-
ET9500C-20-MS	20"	0.160"	1"	-
ET9500C-22-MS	22"	0.160"	1"	-
ET9500C-24-MS	24"	0.160"	1"	-
ET9500C-26-MS	26"	0.160"	1"	-

Slotted smooth hydraulic hose blade

Model	Diameter	Thickness	Arbor	Eaton saw
ET9500C-07-SL	7"	0.093"	5/8"	-
ET9100C-07-SL	7"	0.093"	3/4"	ET9100
ET9500C-08-SL	8"	0.093"	5/8"	-
ET9500C-10-SL	10"	0.062"	5/8"	-
ET9500C-10-1-SL	10"	0.093"	3/4"	-
ET9200C-10-1-SL	10"	0.093"	40mm	ET9200
ET9500C-10-2-SL	10"	0.125"	3/4"	-
ET9500C-10-3-SL	10"	0.125"	1"	-
ET9200C-10-SL	10"	0.125"	40mm	ET9200
ET9500C-12-SL	12"	0.093"	1"	-
ET9500C-12-1-SL	14"	0.125"	1"	-
ET9500C-14-SL	14"	0.125"	1"	-
ET9300C-14-SL	14"	0.160"	40mm	ET9300
ET9500C-16-SL	16"	0.160"	1"	-
ET9500C-18-SL	18"	0.160"	1"	-
ET9500C-20-SL	20"	0.160"	1"	-
ET9500C-20-1-SL	20"	0.160"	40mm	-
ET9500C-21-SL	21"	0.160"	38mm	-
ET9500C-22-SL	22"	0.160"	50mm	-
ET9500C-24-SL	24"	0.160"	1"	-
ET9500C-26-SL	26"	0.160"	1"	-

Assembly equipment

Hose preparation



Refer to page A-2 and applicable machine operator's manuals for safety information.

Hose cutting equipment

T-71

Hose cutting machine

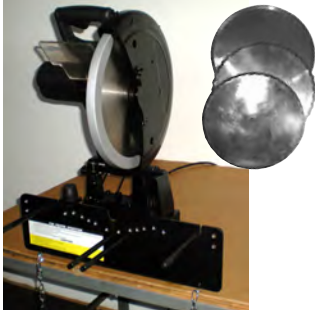

This cutting machine easily handles all 1 and 2 braided wire hose through 4" I.D., up to 2" I.D. 4-spiral and up to 1-1/2" I.D. 6 multi-spiral reinforced hose. That makes this machine ideal for cutting most hydraulic and pneumatic hoses as well as a variety of industrial fluid transfer hoses. The T-71 uses a 14" cutting blade, T-1070, for cutting all 1 & 2 wire braid and through 2" 4 spiral hose. The scalloped toothed blade T-1071, is for cutting industrial

transfer hoses through 4" and the smooth beveled blade, T-1072, for cutting hose with a wire braid cover. T-71 includes a scalloped blade.

The T-71 is shipped with a scalloped blade, T-1070.

Replacement blade:

T-1070 Steel scalloped

T-1071 Steel scalloped toothed

T-1072 Steel smooth beveled

Motor

4.5 H.P., 110/115 volts, single phase, 60 cycle

Size

22" wide, 19" deep, 25" high

Weight

Approx. 85 lbs.

Amps drawn

115 volts – 20 amp

T-135

Plastic tube and hose cutter



An economical alternative to quality tube and hose cutting. This versatile tool is lightweight and durable for long service life.

Replacement blade

T-135B

Capacity

Up to 1" hose I.D.

Note: Not for use with wire-reinforced hose.

T-191

Plastic tube and hose cutter



Only 2-7/8" long, the versatile T-191 offers quick and clean square cuts on 1/16" to 1/2" O.D. plastic tubing and non-wire reinforced hose. The T-191 can be either bench or wall mounted and offers the safety of closing automatically when not in use.

Spare parts

T-191B Replacement blade (one per package)

Presetting tools

7000 Series

Ermeto hand presetting tools



Presetting tools provide a more accurate and positive leak-proof method of coupling flareless fittings. Presetting steel Ermeto sleeves on tubing prior to fitting assembly will permit the maximum high performance obtainable with flareless fittings. Due to possible thread galling, the use of presetting tools is required when assembling stainless steel fittings.

Part number	Tube O.D. (inches)	Thread size
T-7002	1/8	5/16-24
T-7003	3/16	3/8-24
T-7004	1/4	7/16-20
T-7005	5/16	1/2-20
T-7006	3/8	9/16-18
T-7008	1/2	3/4-16
T-7010	5/8	7/8-14
T-7012	3/4	1 1/16-12
T-7016	1	1 5/16-12
T-7020	1-1/4	1 5/8-12
T-7024	1-1/2	1 7/8-12

Hose insertion gauges

FF90308



Improve hose assembly reliability with these easy to use aluminum gauges that are designed to ensure proper fitting depth during pre-assembly.

Simply bottom the hose in the appropriately marked cavity and scribe a mark on the hose flush with the top surface of the gauge. Insert the fitting until the back of the socket is aligned with scribe line.

Part number	Usage
FF90308-01	For use with all hoses that mate with -4 through -16 Z-series fittings
FF90308-02	For use with all hoses that mate with -20, -24, and -32 Z-series fittings
FF90308-04	For use with all hoses that mate with -06, -08, -10, -12, -16 spiral 4S/6S fittings
FF90308-05	For use with all hoses that mate with -20, -24, -32 spiral 4S/6S fittings

Assembly equipment

Hose preparation

L

Hose bore cleaning brushes

Individual brushes



Hose I.D. (inch)	Part number	Bristle O.D. (inch)	Bristle length (inch)	Overall length (inch)
3/16-3/8	T-1106	3/8	2	24
1/2-5/8	T-1110	1/2	3	24
3/4-1	T-1116	1	4	24
1-1/8-1-1/2	T-1124	1-1/2	4	24
2-3	T-1132	2	5	24

T-1100

3-Piece kit



Hose I.D. (inch)	Part number	Bristle O.D. (inch)	Bristle length (inch)	Overall length (inch)
3/16-3/8	T-1106	3/8	2	24
1/2-5/8	T-1110	1/2	3	24
3/4-1	T-1116	1	4	24

FT1312

Hose proof test stand

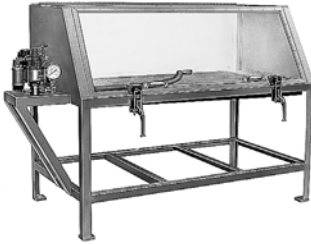

Hose specifications

Assembles up to 2" I.D.,
6 spiral wire

Features

- Designed to use tap water, eliminating the need for a special test fluid
- Compact power unit is air driven
- Air regulator and gauge provide easy pressure adjustment and monitoring
- Tough transparent Lexan™ lid
- 79" x 36" x 53"; 550 lbs

Power unit

The power unit of the FT1312 tester is a compact, economical air driven hydraulic pump. It will provide sufficient hydraulic pressure to proof test any Weatherhead hose assembly, up to 22,000 psi

Lexan is a trademark of General Electric.

FT1312 Standard adapter selection chart

Hose fitting* style and size	Fitting adapter part number	Pressure port adapter part number	Plug or cap part number
SAE 37°(JIC) swivel			
-4	2027-8-4S	**	900599-4
-5	2021-6-5S	2081-12-6S	900599-5
-6	2027-8-6S	**	900599-6
-8	2027-8-8S	**	900599-8
-10	2027-10-08S	**	900599-10
-12	2027-08-12S	**	900599-12
-16	2021-12-16S	**	900599-16
-20	2021-16-20S	2040-12-16S	900599-20
-24	2021-16-24S	2040-12-16S	900599-24
-32	2021-16-32S	2040-12-16S	900599-32
SAE 45° swivel			
-4	2000-06-4B	2081-12-6S	900599-4
-5	2000-06-5B	2081-12-6S	900599-5
-6	2000-06-6B	2081-12-6S	2001-6-6B, 2082-6S
-8	2000-12-8B	**	900599-8
-10	2000-12-10B	**	900599-10
-12	2000-12-12B	**	2001-8-12B, 2082-8S
Male pipe			
-2	2081-08-02S	2081-12-08S	2046-2-2S, 2082-2S
-4	2081-08-04S	2081-12-08S	2046-4-4S, 2082-4S
-6	2081-08-06S	2081-12-08S	2046-6-6S, 2082-6S
-8	2081-08-08S	**	2046-8-8S, 2082-8S
-12		**	2046-12-12S, 2082-12S
-16	2040-12-16S	**	2046-16-16S, 2082-16S
-20	2040-16-20S	2040-12-16S	2046-20-20S, 2082-20S
-24	2040-20-24S	2040-12-16S, 2040-16-20S	2046-24-24S, 2082-24S
-32	2040-24-32S	2040-12-16S, 2040-16-20S, 2040-20-24S	2046-32-32S, 2082-32S

*Two adapters are required per hose assembly to be tested.

**Internal Skive fittings only.

Assembly equipment

Contamination control products

L

FT1455 Series

Projectile cleaning system



FT1455 Series projectile cleaning system

FT1455 Series is focused on eliminating contamination in hydraulic systems. Contamination control is crucial during the preparation processes in assembling fittings on hose, tubes, and pipes.

These systems shoot the FT1355 Series cleaning projectiles through hose, tubes, and pipe assemblies to successfully remove rubber dust and metal particles arising from the hydraulic hose cutting process, remove metal flashings from the hose assembly process (crimping), and remove contaminated oil from hoses, tubes and pipes prior to installation in hydraulics systems.

Features

- Provides industry leading ISO cleanliness levels
- Simple and robust construction
- Available in hand-held and bench-mount configurations
- Ideal for portable small volume applications, and large volume production applications
- Broad variety of projectile and nozzle types and sizes to match application needs
- Minimal setup, works off shop air (80–110 psi)
- Capability: 1/8" to 4 1/2" ID hose, tube or pipe
- Available in kits or individual replacement hardware components
- Kits available with and without projectiles

Typical applications

Hydraulics	<ul style="list-style-type: none">• Removes rubber dust and metal particles from the hydraulic hose cutting process• Removes metal flash from the crimping process on hose and tubes• Removal of contaminated oil from hoses, tubes and pipes in hydraulic systems
Pneumatics	<ul style="list-style-type: none">• Eliminates rubber contamination, metal particles, contaminated oil and moisture that causes breakdowns and inefficiency
Heat exchangers & condenser	<ul style="list-style-type: none">• Eliminates contamination that reduces heat transfer resulting in low level performance
Steam boilers	<ul style="list-style-type: none">• Removes most scaling in steam pipes for maintenance servicing
Air conditioning & refrigeration	<ul style="list-style-type: none">• Eliminates minute particles in copper tubes and coolant lines that affect system performance
Oxygen & gas	<ul style="list-style-type: none">• Eliminates oil, grease and other contaminants from copper or S/S tubing
Oil, gas & chemical processing	<ul style="list-style-type: none">• Efficient cleaning of pipes as part of service maintenance
Earthmoving equipment	<ul style="list-style-type: none">• Maintenance reduction in flushing time and filter usage
Automotive & servicing	<ul style="list-style-type: none">• Cleaning of fuel lines and brake lines prior to assembly and servicing of components
Food & beverage	<ul style="list-style-type: none">• Product recovery retrieval of product from lines. Reducing or eliminating solvents or detergents
Gun barrels	<ul style="list-style-type: none">• To remove rust, scale or powder residue much faster than brushing or swabbing

For more information on the Contamination Control Products go to E-HOIN-TT032-E2.

FT1455 Series Hardware

FT1455-L1



Hand held projectile cleaning hardware for small hose diameters (up to 1-1/4" hose ID)

- Capability – For use with 1/8" through 1/4" ID hose, tube or pipe assemblies
- Construction – Simple construction with durable brass and aluminum parts with rigid plastic handle
- Form factor – Hand-held, portable - ideal for mobile applications

- Typical applications: small volume hose shop environments
- Includes hand-held launcher hardware only. Does not include adapter rings and nozzles for operation. Intended for replacement purposes only

FT1455-L2



Hand held projectile cleaning hardware for medium hose diameters (up to 2" hose ID)

- Capability – For use with 1/8" through 2" ID hose, tube or pipe assemblies
- Construction - Precision machined aluminum with fully anodized components
- Form factor – Hand-held, portable – ideal for harsh environments and heavy use

- Typical applications: Production hose and tube shops, mobile hose fabricators and mobile applications
- Includes hand-held launcher hardware only. Does not include adapter rings and nozzles for operation. Intended for replacement purposes only

FT1455-L3



Hand held projectile cleaning hardware for large hose diameters (up to 3-1/2" hose ID)*

- Capability – For use with 1/8" through 3-1/2" ID hose, tube or pipe assemblies
- Construction - Precision machined aluminum with fully anodized components
- Form factor – Hand-held, portable – ideal for harsh environments and heavy use

- Typical applications: Production hose and tube shops, mobile hose fabricators and mobile applications
- Includes hand-held launcher hardware only. Does not include adapter rings and nozzles for operation. Intended for replacement purposes only

FT1455-L4



Bench mount projectile cleaning hardware kit for small hose diameters (up to 1-1/4" hose ID)

- Capability – For use with 1/8" through 1-1/4" ID hose, tube or pipe assemblies
- Construction – Stainless steel housing with anodized aluminum components
- Form factor – Bench mount – ideal for production assemblies (1.2 second cycle time)

- Typical applications: Production hose and tube shops
- Includes bench mount launcher hardware, 5 micron air filter, pneumatic foot switch and twin line air hose and 7 nozzles for hose ID ranging from 1/4" through 1-1/4"

Note: For proper operation the following are required:

- 80 psi (5.5 Bar) minimum to 110 psi (7.5 Bar) maximum air pressure
- 1/2" ID air hose with a minimum of 55 SCFM (1.6 m³/min) air flow rate†
- 5 micron air filter and regulator with gauge are strongly suggested
- A large industrial compressor is strongly recommended
- A compressed air dryer is strongly recommended

†A minimum of 38 SCFM (1.1 m³/min) air flow rate at 80 psi (5.5 bar) is required for FT1455-L3 launcher

*FT1455-L3 can be converted to work on hose ID up to 4" with the addition of FT1455-N-45 4-1/2" aluminum locking nozzle.

Assembly equipment

Contamination control products

L

FT1455 Series

Projectile cleaning system kits

FT1455-K1



Hand held projectile cleaning kit for small hose diameters (up to 1-1/4" hose ID)

- Capability – For use with 1/4" through 1-1/4" ID hose, tube or pipe assemblies
- Construction – Simple construction with durable brass and aluminum parts with rigid plastic handle

- Form factor – Hand-held, portable – ideal for mobile applications
- Typical applications – small volume hose shop environments

FT1455-K2



Hand held projectile cleaning starter kit for small hose diameters (up to 1-1/4" hose ID)

- Capability – For use with 1/4" through 1-1/4" ID hose, tube or pipe assemblies
- Construction – Simple construction with durable brass and aluminum parts with rigid plastic handle

- Form factor – Hand-held, portable – ideal for mobile applications
- Typical applications – small volume hose shop environments
- Catch can not included

FT1455-K3



Hand held projectile cleaning kit for medium hose diameters (up to 2" hose ID)

- Capability – For use with 1/4" through 2" ID hose, tube or pipe assemblies
- Construction – Precision machined aluminum with fully anodized components

- Form factor – Hand-held, portable – ideal for harsh environments and heavy use
- Typical applications – Production hose and tube shops, mobile hose fabricators and mobile applications

FT1455-K4



Hand held projectile cleaning kit for medium hose diameters (up to 2" hose ID)

- Capability – For use with 1/8" through 2" ID hose, tube or pipe assemblies
- Construction – Precision machined aluminum with fully anodized components

- Form factor – Hand-held, portable – ideal for harsh environments and heavy use
- Typical applications – Production hose and tube shops, mobile hose fabricators and mobile applications

FT1455-K5



Hand held projectile cleaning hardware kit for large hose diameters (up to 3-1/2" hose ID)

- Capability – For use with 1/8" through 4-1/2" hose, tube or pipe assemblies
- Construction – Precision machined aluminum with fully anodized components

- Form factor – Hand-held, portable – ideal for harsh environments and heavy use
- Typical applications – Production hose and tube shops, mobile hose fabricators and mobile applications

FT1455 Series Cleaning nozzles

Broad variety of nozzles are available allowing the operator to select the ideal nozzle for each application based on the different size and type of hoses, hose fittings, tube and pipe assemblies. All nozzle sizes are denoted by the projectile exit diameter (mm).



FT1455-N-HXX

Nozzles for hose assemblies

- Universal nozzle for use with hoses
- Also work on pipe, heavy walled tubing and many fitting configurations



FT1455-NT-XX

Nozzles for tube assemblies (Inch)

- Nominal inch tube nozzles have a lip on the inside that forms an airtight seal when tube is fully inserted into the nozzle



FT1455-J-XX

Nozzles for hose assemblies with JIC fittings

- Nozzles molded with 37° male flare on tip to fit female JIC fittings on hose assemblies



FT1455-NT-XXXXX

Nozzles for tube assemblies (Metric)

- Metric tube nozzles have a lip on the inside that forms an airtight seal when tube is fully inserted into the nozzle
- Metric tube nozzle designations utilize the largest wall thickness for a given outside diameter, but fit all smaller wall thicknesses as well

Part number	Description
FT1455-N-HXX	Nozzles for hose assemblies
FT1455-N-H06	Hose nozzle (1/4")
FT1455-N-H08	Hose nozzle (5/16")
FT1455-N-H10	Hose nozzle (3/8")
FT1455-N-H13	Hose nozzle (1/2")
FT1455-N-H16	Hose nozzle (5/8")
FT1455-N-H19	Hose nozzle (3/4")
FT1455-N-H25	Hose nozzle (1")
FT1455-N-H32	Hose nozzle (1 1/4")
FT1455-N-H38	Hose nozzle (1 1/2")
FT1455-N-H50	Hose nozzle (2")
FT1455-N-U55	Universal hose nozzle (1 1/8" thru 3 1/2")
FT1455-N-45	4 1/2" aluminum locking nozzle

FT1455-J-XX	Nozzles for hose assemblies with JIC fittings
FT1455-J-06	JIC nozzle (4 1/2")
FT1455-J-10	JIC nozzle (4 1/2")
FT1455-J-13	JIC/TUBE nozzle (-8, 1/2")
FT1455-J-16	JIC/TUBE nozzle (-10, 5/8")
FT1455-J-19	JIC/TUBE nozzle (-12, 3/4")
FT1455-J-25	JIC/TUBE nozzle (-16, 1" & 7/8")
FT1455-J-32	JIC/TUBE nozzle (-20, 1 1/4" & 1")
FT1455-J-38	JIC/TUBE nozzle (-24, 1 1/2")
FT1455-J-50	JIC/TUBE nozzle (-32, 2")

FT1455-NT-XX	Nozzles for tube assemblies (Inch)
FT1455-NT-32	TUBE nozzle 1 1/4" OD
FT1455-NT-06	TUBE nozzle 1/4" OD
FT1455-NT-03	TUBE nozzle 1/8" OD
FT1455-NT-10	TUBE nozzle 3/8" OD
FT1455-NT-08	TUBE nozzle 5/16" OD

FT1455-NT-XX	Nozzles for tube assemblies (Metric) Outside diameter X wall thickness
FT1455-NT-06x1.5	Metric tube nozzle UC-6 X 1.5
FT1455-NT-08x1.5	Metric tube nozzle UC-8 X 1.5
FT1455-NT-10x1.5	Metric tube nozzle UC-10 X 1.5
FT1455-NT-12x2.0	Metric tube nozzle UC-12 X 2.0
FT1455-NT-14x2.0	Metric tube nozzle UC-14 X 2.0
FT1455-NT-15x2.0	Metric tube nozzle UC-15 X 2.0
FT1455-NT-16x2.5	Metric tube nozzle UC-16 X 2.5
FT1455-NT-18x2.5	Metric tube nozzle UC-18 X 2.5
FT1455-NT-20x3.0	Metric tube nozzle UC-20 X 3.0
FT1455-NT-22x2.0	Metric tube nozzle UC-22 X 2.0
FT1455-NT-25x3.0	Metric tube nozzle UC-25 X 3.0
FT1455-NT-28x2.5	Metric tube nozzle UC-28 X 2.5
FT1455-NT-30x4.0	Metric tube nozzle UC-30 X 4.0
FT1455-NT-35x3.0	Metric tube nozzle UC-35 X 3.0
FT1455-NT-38x5.0	Metric tube nozzle UC-38 X 5.0
FT1455-NT-42x3.0	Metric tube nozzle UC-42 X 3.0
FT1455-NT-50x5.0	Metric tube nozzle UC-50 X 5.0
FT1455-4FFORX	Nozzle for use with flat face O-Ring seal fittings (FROS)

Assembly equipment

Contamination control products

L

FT1455 Series

Adapter & locking rings



FT1455-L2-AR1

Adapter ring

Adapter ring for FT1455-L2 launcher to receive 1/8" thru 1-1/4" nozzles

- FT1455-L2-AR1 adapter ring fits the FT1455-L2 hand held launcher and all nozzle types and sizes between 1/8" and 1-1/4"



FT1455-L3-LR

Locking ring

3-1/2" aluminum locking ring for FT1455-L3 launcher

- FT1455-L3-LR locking ring fits FT1455-L3 hand held launcher, both FT1455-L3-AR2 & FT1455-L3-AR3 adapter rings, and FT1455-N-U55 Universal hose nozzle



FT1455-L3-AR2

Adapter ring

Adapter ring for FT1455-L3 launcher to receive 1/8" thru 1-1/4" nozzles

- FT1455-L3-AR2 adapter ring fits the FT1455-L3 hand held launcher and all nozzle types and sizes between 1/8" and 1-1/4"



FT1455-L3-AR3

Adapter ring

Adapter ring for FT1455-L3 launcher to receive 1-1/2" thru 2" nozzles

- FT1455-L3-AR2 adapter ring fits the FT145

FT1455 Series Accessories



FT1455-NH25

Desktop nozzle holder

- The desktop nozzle holder is a great alternative to storing the nozzles in the carrying case
- Can be easily attached to the workbench and offers easy access during change overs and operation
- Accommodates all types of nozzles ranging from 1/4" to 2"



FT1455-QC

Quick release coupling

- Quick release coupling offers a quick disconnect and exchange of air supply to all 3 models of hand held projectile launchers
- Ideal for portable applications that require frequent disconnects



FT1455-CC

Carrying case

- Convenient carrying case to store and carry the hand held projectile launchers and relevant nozzles
- Works with all 3 models of hand held projectile launchers

FT1455 Operating Instructions



E-HOAI-CC001-E
FT1455-L1 Hand Launcher
Operating Instructions



E-HOAI-CC002-E
FT1455-L2 Hand Launcher
Operating Instructions



E-HOAI-CC003-E
FT1455-L3 Hand Launcher
Operating Instructions



E-HOAI-CC004-E
FT1455-L4 Bench Mount
Launcher Operating
Instructions

Assembly equipment

Contamination control products

L

FT1455 and FT1355 Series

Recommended nozzles and cleaning projectiles for hoses and hose assemblies

Recommendations for hoses

Nominal hose diameter

Inches	mm	Nozzle part no.	Cleaning projectile part no.
3/16	05	FT1455-N-H06	FT1355-H-06 -
1/4	06	FT1455-N-H06	FT1355-H-10 or FT1355-H-12
5/16	08	FT1455-N-H08	FT1355-H-12 or FT1355-H-14
3/8	10	FT1455-N-H10	FT1355-H-14 or FT1355-H-16
1/2	13	FT1455-N-H13	FT1355-H-18 or FT1355-H-20
5/8	16	FT1455-N-H16	FT1355-H-22 -
3/4	19	FT1455-N-H19	FT1355-H-26 -
1	25	FT1455-N-H25	FT1355-H-33 or FT1355-H-36
1 1/4	32	FT1455-N-H32	FT1355-H-40 or FT1355-H-45
1 1/2	38	FT1455-N-H38	FT1355-H-50 or FT1355-H-55
2	50	FT1455-N-H50	FT1355-H-60 or FT1355-H-65
2 1/2	63	FT1455-N-U55	FT1355-H-75 -
3	76	FT1455-N-U55	FT1355-H-85 -
3 1/2	89	FT1455-N-U55	FT1355-H-100 -
4	102	FT1455-N-45	- -
4 1/2	114	FT1455-N-45	- -

Recommendations for hose assemblies with ORS fittings

ORS fitting dash size	Nozzle part no.	Cleaning projectile part no.
-4	FT1455-4FFORX	FT1355-H-06 or FT1355-H-07
-6	FT1455-N-H06	FT1355-H-12 -
-8	FT1455-N-H10	FT1355-H-16 -
-10	FT1455-N-H13	FT1355-H-22 -
-12	FT1455-N-H16	FT1355-H-26 -
-16	FT1455-N-H19	FT1355-H-33 -
-20	FT1455-N-H25	FT1355-H-40 -

Recommendations for hose assemblies with Code 61 or 62 flanges

Code 61 or 62 flange dash size	Nozzle part no.	Cleaning projectile part no.
-8	FT1455-N-H10	FT1355-H-16
-10	FT1455-N-H13	FT1355-H-22
-12	FT1455-N-H16	FT1355-H-26
-16	FT1455-N-H19	FT1355-H-33
-20	FT1455-N-H25	FT1355-H-40
-24	FT1455-N-H32	FT1355-H-50
-32	FT1455-N-H32	FT1355-H-60

Recommendations for hose assemblies with JIC fittings

JIC fitting dash size	Nozzle part no.	Cleaning projectile part no.
-4	FT1455-J-06	FT1355-H-06 or FT1355-H-07
-6	FT1455-J-10	FT1355-H-12
-8	FT1455-J-13	FT1355-H-16
-10	FT1455-J-16	FT1355-H-22
-12	FT1455-J-19	FT1355-H-26
-16	FT1455-J-25	FT1355-H-33
-20	FT1455-J-32	FT1355-H-40
-24	FT1455-J-38	FT1355-H-50
-32	FT1455-J-50	FT1355-H-60

FT1455 and FT1355 Series

Recommended nozzles and cleaning projectiles for pipes and tubes

Recommended nozzles and cleaning projectiles for pipes (inch)

SCH 40	Nozzle part #	Cleaning projectile part #	Abrasive projectile part #
1/4"	FT1455-N-H08	FT1355-H-14	FT1355-A-12
3/8"	FT1455-N-H13	FT1355-H-18	FT1355-A-16
1/2"	FT1455-N-H16	FT1355-H-20	FT1355-A-18
3/4"	FT1455-N-H19	FT1355-H-30	FT1355-A-26
1"	FT1455-N-H25	FT1355-H-36	FT1355-A-33
1 1/4"	FT1455-N-H32	FT1355-H-45	FT1355-A-40
1 1/2"	FT1455-N-H38	FT1355-H-55	FT1355-A-50
2"	FT1455-N-H50	FT1355-H-65	-
2 1/2"	FT1455-N-U55	FT1355-H-75	-
3"	FT1455-N-U55	FT1355-H-85	-
3 1/2"	FT1455-N-U55	FT1355-H-100	-

SCH 80	Nozzle part #	Cleaning projectile part #	Abrasive projectile part #
1/4"	FT1455-N-H06	FT1355-H-12	FT1355-A-10
3/8"	FT1455-N-H10	FT1355-H-16	FT1355-A-14
1/2"	FT1455-N-H13	FT1355-H-20	FT1355-A-16 or FT1355-A-18
3/4"	FT1455-N-H19	FT1355-H-26	FT1355-A-22
1"	FT1455-N-H25	FT1355-H-36	FT1355-A-30
1 1/4"	FT1455-N-H32	FT1355-H-45	FT1355-A-40
1 1/2"	FT1455-N-H38	FT1355-H-50	FT1355-A-45
2"	FT1455-N-H38	FT1355-H-60	FT1355-A-55
2 1/2"	FT1455-N-H50	FT1355-H-70	-
3"	FT1455-N-U55	FT1355-H-85	-
3 1/2"	FT1455-N-U55	FT1355-H-100	-

SCH 160	Nozzle Part #	Cleaning projectile part #	Abrasive projectile part #
1/2"	FT1455-N-H10	FT1355-H-16	FT1355-A-14
3/4"	FT1455-N-H16	FT1355-H-20	FT1355-A-18
1"	FT1455-N-H19	FT1355-H-30	FT1355-A-26
1 1/4"	FT1455-N-H25	FT1355-H-36	FT1355-A-33
1 1/2"	FT1455-N-H32	FT1355-H-45	FT1355-A-40
2"	FT1455-N-H38	FT1355-H-55	FT1355-A-45 or FT1355-A-50
2 1/2"	FT1455-N-H50	FT1355-H-65	FT1355-A-60
3"	FT1455-N-U55	FT1355-H-75	-
4"	FT1455-N-U55	FT1355-H-100	-

Recommended nozzles and cleaning projectiles for tubes (inch)

Outside diameter x wall thickness	Nozzle part #	Cleaning projectile part #	Abrasive projectile part #	Tube projectile part #
1/8" X 0.030"	FT1455-NT-3	-	-	-
1/4" X 0.035"	FT1455-NT-6	FT1355-H-10	FT1355-A-07	FT1355-T-06
1/4" X 0.049"	FT1455-NT-6	FT1355-H-08	FT1355-A-07	FT1355-T-06
1/4" X 0.065"	FT1455-NT-6	FT1355-H-07	-	FT1355-T-06
5/16" X 0.035"	FT1455-NT-8	FT1355-H-12	FT1355-A-10	FT1355-T-07
3/8" X 0.035"-0.049"	FT1455-NT-10	FT1355-H-14	FT1355-A-12	FT1355-T-10
3/8" X 0.065"	FT1455-NT-10	FT1355-H-12	FT1355-A-10	FT1355-T-10
1/2" X 0.035"	FT1455-J-13	FT1355-H-16	FT1355-A-16	FT1355-T-14
1/2" X 0.049"	FT1455-J-13	FT1355-H-16	FT1355-A-16	FT1355-T-12
1/2" X 0.065"	FT1455-J-13	FT1355-H-16	FT1355-A-14	FT1355-T-12
1/2" X 0.083"	FT1455-J-13	FT1355-H-14	FT1355-A-12	FT1355-T-12
5/8" X 0.049"	FT1455-J-16	FT1355-H-22	FT1355-A-20	FT1355-T-16
5/8" X 0.065"	FT1455-J-16	FT1355-H-20	FT1355-A-18	FT1355-T-16
5/8" X 0.083"	FT1455-J-16	FT1355-H-20	FT1355-A-18	FT1355-T-14
3/4" X 0.049"-0.065"	FT1455-J-19	FT1355-H-26	FT1355-A-24	FT1355-T-20
3/4" X 0.095"	FT1455-J-19	FT1355-H-22	FT1355-A-20	FT1355-T-18
7/8" X 0.049"	FT1455-J-25	FT1355-H-33	FT1355-A-30	FT1355-T-26
7/8" X 0.065"	FT1455-J-25	FT1355-H-30	FT1355-A-28	FT1355-T-22
7/8" X 0.095"	FT1455-N-H16	FT1355-H-28	FT1355-A-26	FT1355-T-22
1" X 0.065"	FT1455-J-32	FT1355-H-33	FT1355-A-30	FT1355-T-28
1" X 0.083"-0.095"	FT1455-J-32	FT1355-H-33	FT1355-A-30	FT1355-T-26
1" X 0.120"	FT1455-J-32	FT1355-H-30	FT1355-A-28	FT1355-T-26
1 1/4" X 0.065"	FT1455-NT-32	FT1355-H-40	FT1355-A-40	FT1355-T-33
1 1/4" X 0.083"	FT1455-NT-32	FT1355-H-40	FT1355-A-36	FT1355-T-33
1 1/4" X 0.095"	FT1455-NT-32	FT1355-H-40	FT1355-A-36	FT1355-T-33
1 1/4" X 0.109"	FT1455-NT-32	FT1355-H-36	FT1355-A-36	FT1355-T-33
1 1/4" X 0.120"	FT1455-NT-32	FT1355-H-36	FT1355-A-33	FT1355-T-33
1 1/2" X 0.065"-0.120"	FT1455-J-38	FT1355-H-50	FT1355-A-45	FT1355-T-40
1 1/2" X 0.134"-0.148"	FT1455-J-38	FT1355-H-45	FT1355-A-40	FT1355-T-40
2" X 0.065"-0.120"	FT1455-J-50	FT1355-H-60	FT1355-A-55	FT1355-T-50
2" X 0.134"-0.188"	FT1455-J-50	FT1355-H-55	FT1355-A-50	FT1355-T-50

Assembly equipment

Contamination control products

L

FT1455 and FT1355 Series

Recommended nozzles and cleaning projectiles for tubes (metric)

Outside diameter x Wall thickness	Nozzle part #	Cleaning projectile part #	Abrasive projectile part #	Tube projectile part #	Outside diameter x wall thickness	Nozzle part #	Cleaning projectile part #	Abrasive projectile part #	Tube projectile part #
6 X 1.0	FT1455-NT-06x1.5	FT1355-H-07	FT1355-A-06	FT1355-T-06	22 X 1	FT1455-NT-22x2.0	FT1355-H-30	FT1355-A-28	FT1355-T-26
6 X 1.5	FT1455-NT-06x1.5	FT1355-H-07	FT1355-A-06	-	22 X 1.5	FT1455-NT-22x2.0	FT1355-H-30	FT1355-A-28	FT1355-T-26
8 X 1.0	FT1455-NT-08x1.5	FT1355-H-10	FT1355-A-07	FT1355-T-07	22 X 2	FT1455-NT-22x2.0	FT1355-H-30	FT1355-A-28	FT1355-T-26
8 X 1.5	FT1455-NT-08x1.5	FT1355-H-10	FT1355-A-07	FT1355-T-07	25 X 2	FT1455-NT-25x3.0	FT1355-H-33	FT1355-A-30	FT1355-T-28
10 X 1.0	FT1455-NT-10x1.5	FT1355-H-14	FT1355-A-12	FT1355-T-12	25 X 2.5	FT1455-NT-25x3.0	FT1355-H-30	FT1355-A-28	FT1355-T-26
10 X 1.5	FT1455-NT-10x1.5	FT1355-H-14	FT1355-A-12	FT1355-T-12	25 X 3	FT1455-NT-25x3.0	FT1355-H-30	FT1355-A-28	FT1355-T-26
12 X 1.0	FT1455-NT-12x2.0	FT1355-H-16	FT1355-A-14	FT1355-T-14	28 X 2	FT1455-NT-28x2.5	FT1355-H-36	FT1355-A-33	FT1355-T-33
12 X 1.5	FT1455-NT-12x2.0	FT1355-H-16	FT1355-A-14	FT1355-T-14	28 X 2.5	FT1455-NT-28x2.5	FT1355-H-36	FT1355-A-33	FT1355-T-30
12 X 2.0	FT1455-NT-12x2.0	FT1355-H-14	FT1355-A-12	FT1355-T-12	30 X 2	FT1455-NT-30x4.0	FT1355-H-36	FT1355-A-33	FT1355-T-33
14 X 1.0	FT1455-NT-14x2.0	FT1355-H-18	FT1355-A-16	FT1355-T-16	30 X 2.5	FT1455-NT-30x4.0	FT1355-H-36	FT1355-A-33	FT1355-T-30
14 X 1.5	FT1455-NT-14x2.0	FT1355-H-16	FT1355-A-14	FT1355-T-14	30 X 3	FT1455-NT-30x4.0	FT1355-H-36	FT1355-A-33	FT1355-T-30
14 X 2.0	FT1455-NT-14x2.0	FT1355-H-16	FT1355-A-14	FT1355-T-14	30 X 4	FT1455-NT-30x4.0	FT1355-H-36	FT1355-A-33	FT1355-T-30
15 X 1.0	FT1455-NT-15x2.0	FT1355-H-20	FT1355-A-18	FT1355-T-16	35 X 2	FT1455-NT-35x3.0	FT1355-H-45	FT1355-A-40	FT1355-T-40
15 X 1.5	FT1455-NT-15x2.0	FT1355-H-18	FT1355-A-16	FT1355-T-16	35 X 3	FT1455-NT-35x3.0	FT1355-H-40	FT1355-A-36	FT1355-T-36
15 X 2.0	FT1455-NT-15x2.0	FT1355-H-16	FT1355-A-14	FT1355-T-14	35 X 4	FT1455-N-H25	FT1355-H-40	FT1355-A-36	FT1355-T-33
16 X 1.0	FT1455-NT-16x2.5	FT1355-H-22	FT1355-A-20	FT1355-T-18	35 X 5	FT1455-N-H25	FT1355-H-36	FT1355-A-33	FT1355-T-30
16 X 1.5	FT1455-NT-16x2.5	FT1355-H-20	FT1355-A-18	FT1355-T-16	38 X 2.5	FT1455-NT-38x5.0	FT1355-H-50	FT1355-A-45	FT1355-T-40
16 X 2.0	FT1455-NT-16x2.5	FT1355-H-18	FT1355-A-16	FT1355-T-16	38 X 3	FT1455-NT-38x5.0	FT1355-H-50	FT1355-A-45	FT1355-T-40
16 X 2.5	FT1455-NT-16x2.5	FT1355-H-16	FT1355-A-14	FT1355-T-14	38 X 4	FT1455-NT-38x5.0	FT1355-H-45	FT1355-A-40	FT1355-T-40
18 X 1.0	FT1455-NT-18x2.5	FT1355-H-24	FT1355-A-22	FT1355-T-20	38 X 5	FT1455-NT-38x5.0	FT1355-H-40	FT1355-A-36	FT1355-T-36
18 X 1.5	FT1455-NT-18x2.5	FT1355-H-24	FT1355-A-20	FT1355-T-18	42 X 2	FT1455-NT-42x3.0	FT1355-H-55	FT1355-A-50	FT1355-T-50
18 X 2.0	FT1455-NT-18x2.5	FT1355-H-22	FT1355-A-20	FT1355-T-18	42 X 3	FT1455-NT-42x3.0	FT1355-H-50	FT1355-A-50	FT1355-T-45
18 X 2.5	FT1455-NT-18x2.5	FT1355-H-20	FT1355-A-18	FT1355-T-16	50 X 3	FT1455-NT-50x5.0	FT1355-H-60	FT1355-A-55	FT1355-T-55
20 X 1.5	FT1455-NT-20x3.0	FT1355-H-26	FT1355-A-24	FT1355-T-22	50 X 5	FT1455-NT-50x5.0	FT1355-H-55	FT1355-A-55	FT1355-T-50
20 X 2.0	FT1455-NT-20x3.0	FT1355-H-24	FT1355-A-22	FT1355-T-20	50 X 6	FT1455-NT-50x5.0	FT1355-H-55	FT1355-A-50	FT1355-T-50
20 X 2.5	FT1455-NT-20x3.0	FT1355-H-24	FT1355-A-20	FT1355-T-18					
20 X 3	FT1455-NT-20x3.0	FT1355-H-22	FT1355-A-20	FT1355-T-18					

FT1355 Series

Cleaning projectiles for hose, tube and pipe assemblies

FT1355 cleaning projectiles work by being compressed against the internal surface of the hose, tube or pipe. Cleaning projectile selection should favor a diameter 20% to 30% larger than the internal diameter of the hose, tube or pipe being cleaned.

Projectiles are available in 3 variations as outlined below, and are manufactured from virgin materials with a specific cell structure and density to match the application's needs. Appropriate selection of the cleaning projectile based on the type of application ensures effective cleaning.



FT1355-H-XX

Hose cleaning projectiles for hose assemblies

- Universal cleaning projectile for use with hose, tube and pipe assemblies
- Removes fine particles of loose contaminants after cutting operations
- Can also be used for product purging prior to assembly

FT1355-H-XX Cleaning projectiles for hose assemblies

Part no.	Description
FT1355-H-05	Hose cleaning projectile (05mm)
FT1355-H-06	Hose cleaning projectile (06mm)
FT1355-H-07	Hose cleaning projectile (07mm)
FT1355-H-08	Hose cleaning projectile (08mm)
FT1355-H-10	Hose cleaning projectile (10mm)
FT1355-H-12	Hose cleaning projectile (12mm)
FT1355-H-14	Hose cleaning projectile (14mm)
FT1355-H-16	Hose cleaning projectile (16mm)
FT1355-H-18	Hose cleaning projectile (18mm)
FT1355-H-20	Hose cleaning projectile (20mm)
FT1355-H-22	Hose cleaning projectile (22mm)
FT1355-H-24	Hose cleaning projectile (24mm)
FT1355-H-26	Hose cleaning projectile (26mm)
FT1355-H-28	Hose cleaning projectile (28mm)
FT1355-H-30	Hose cleaning projectile (30mm)
FT1355-H-33	Hose cleaning projectile (33mm)
FT1355-H-36	Hose cleaning projectile (36mm)
FT1355-H-40	Hose cleaning projectile (40mm)
FT1355-H-45	Hose cleaning projectile (45mm)
FT1355-H-50	Hose cleaning projectile (50mm)
FT1355-H-55	Hose cleaning projectile (55mm)
FT1355-H-60	Hose cleaning projectile (60mm)
FT1355-H-65	Hose cleaning projectile (65mm)
FT1355-H-70	Hose cleaning projectile (70mm)
FT1355-H-75	Hose cleaning projectile (75mm)
FT1355-H-80	Hose cleaning projectile (80mm)
FT1355-H-85	Hose cleaning projectile (85mm)
FT1355-H-90	Hose cleaning projectile (90mm)
FT1355-H-95	Hose cleaning projectile (95mm)
FT1355-H-100	Hose cleaning projectile (100mm)

Assembly equipment

Contamination control products

L

FT1355 Series

Cleaning projectiles for tube and pipe assemblies



FT1355-A-XX

Abrasive cleaning projectiles for tube and pipe assemblies

- For use with tubes or pipe assemblies
- Removes mild to medium amounts of contaminants including surface rust and scale build-up
- Can be used multiple times

FT1355-A-XX Abrasive cleaning projectiles for tube and pipe assemblies

Part no.	Description
FT1355-A-06	Abrasive cleaning projectile (06mm)
FT1355-A-07	Abrasive cleaning projectile (07mm)
FT1355-A-10	Abrasive cleaning projectile (10mm)
FT1355-A-12	Abrasive cleaning projectile (12mm)
FT1355-A-14	Abrasive cleaning projectile (14mm)
FT1355-A-16	Abrasive cleaning projectile (16mm)
FT1355-A-18	Abrasive cleaning projectile (18mm)
FT1355-A-20	Abrasive cleaning projectile (20mm)
FT1355-A-22	Abrasive cleaning projectile (22mm)
FT1355-A-24	Abrasive cleaning projectile (24mm)
FT1355-A-26	Abrasive cleaning projectile (26mm)
FT1355-A-28	Abrasive cleaning projectile (28mm)
FT1355-A-30	Abrasive cleaning projectile (30mm)
FT1355-A-33	Abrasive cleaning projectile (33mm)
FT1355-A-36	Abrasive cleaning projectile (36mm)
FT1355-A-40	Abrasive cleaning projectile (40mm)
FT1355-A-45	Abrasive cleaning projectile (45mm)
FT1355-A-50	Abrasive cleaning projectile (50mm)
FT1355-A-55	Abrasive cleaning projectile (55mm)
FT1355-A-60	Abrasive cleaning projectile (60mm)



FT1355-T-XX

Tube cleaning projectiles for tube and pipe assemblies

- Cleaning projectiles for use with tube and pipe assemblies
- Removes mild to medium amounts of contaminants including surface rust and scale build-up
- Removes mandrel lubricants, grease and other oils typically used in bending processes
- Strongly recommended for cleaning stainless steel tubes

FT1355-T-XX Tube cleaning projectiles for tube assemblies

Part no.	Description
FT1355-T-06	Tube cleaning projectile (06mm)
FT1355-T-07	Tube cleaning projectile (07mm)
FT1355-T-10	Tube cleaning projectile (10mm)
FT1355-T-12	Tube cleaning projectile (12mm)
FT1355-T-14	Tube cleaning projectile (14mm)
FT1355-T-16	Tube cleaning projectile (16mm)
FT1355-T-18	Tube cleaning projectile (18mm)
FT1355-T-20	Tube cleaning projectile (20mm)
FT1355-T-22	Tube cleaning projectile (22mm)
FT1355-T-24	Tube cleaning projectile (24mm)
FT1355-T-26	Tube cleaning projectile (26mm)
FT1355-T-28	Tube cleaning projectile (28mm)
FT1355-T-30	Tube cleaning projectile (30mm)
FT1355-T-33	Tube cleaning projectile (33mm)
FT1355-T-36	Tube cleaning projectile (36mm)
FT1355-T-40	Tube cleaning projectile (40mm)
FT1355-T-45	Tube cleaning projectile (45mm)
FT1355-T-50	Tube cleaning projectile (50mm)
FT1355-T-55	Tube cleaning projectile (55mm)
FT1355-T-60	Tube cleaning projectile (60mm)

FT1355 Series

Cleaning projectile selection ordering guidelines

Order quantity is one bag
(ex.. A 1 piece order will be for the full bag quantity noted below)

Eaton projectile part number	Description	Qty / bag	Eaton projectile part number	Description	Qty / bag	Eaton projectile part number	Description	Qty / bag
FT1355-A-06	ABRASIVE (06mm) (Pkg 100)	100	FT1355-H-12	Low density hose projectile (12mm) (Pkg 100)	100	FT1355-T-07	Tube projectile (07mm) (Pkg 100)	100
FT1355-A-07	ABRASIVE (07mm) (Pkg 100)	100	FT1355-H-14	Low density hose projectile (14mm) (Pkg 100)	100	FT1355-T-10	Tube projectile (10mm) (Pkg 100)	100
FT1355-A-10	ABRASIVE (10mm) (Pkg 100)	100	FT1355-H-16	Low density hose projectile (16mm) (Pkg 100)	100	FT1355-T-12	Tube projectile (12mm) (Pkg 100)	100
FT1355-A-12	ABRASIVE (12mm) (Pkg 100)	100	FT1355-H-18	Low density hose projectile (18mm) (Pkg 100)	100	FT1355-T-14	Tube projectile (14mm) (Pkg 100)	100
FT1355-A-14	ABRASIVE (14mm) (Pkg 100)	100	FT1355-H-20	Low density hose projectile (20mm) (Pkg 50)	50	FT1355-T-16	Tube projectile (16mm) (Pkg 100)	100
FT1355-A-16	ABRASIVE (16mm) (Pkg 100)	100	FT1355-H-22	Low density hose projectile (22mm) (Pkg 50)	50	FT1355-T-18	Tube projectile (18mm) (Pkg 100)	100
FT1355-A-18	ABRASIVE (18mm) (Pkg 100)	100	FT1355-H-24	Low density hose projectile (24mm) (Pkg 50)	50	FT1355-T-20	Tube projectile (20mm) (Pkg 50)	50
FT1355-A-20	ABRASIVE (20mm) (Pkg 50)	50	FT1355-H-26	Low density hose projectile (26mm) (Pkg 50)	50	FT1355-T-22	Tube projectile (22mm) (Pkg 50)	50
FT1355-A-22	ABRASIVE (22mm) (Pkg 50)	50	FT1355-H-28	Low density hose projectile (28mm) (Pkg 40)	40	FT1355-T-24	Tube projectile (24mm) (Pkg 50)	50
FT1355-A-24	ABRASIVE (24mm) (Pkg 50)	50	FT1355-H-30	Low density hose projectile (30mm) (Pkg 40)	40	FT1355-T-26	Tube projectile (26mm) (Pkg 50)	50
FT1355-A-26	ABRASIVE (26mm) (Pkg 50)	50	FT1355-H-33	Low density hose projectile (33mm) (Pkg 40)	40	FT1355-T-28	Tube projectile (28mm) (Pkg 40)	40
FT1355-A-28	ABRASIVE (28mm) (Pkg 40)	40	FT1355-H-36	Low density hose projectile (36mm) (Pkg 30)	30	FT1355-T-30	Tube projectile (30mm) (Pkg 40)	40
FT1355-A-30	ABRASIVE (30mm) (Pkg 40)	40	FT1355-H-40	Low density hose projectile (40mm) (Pkg 30)	30	FT1355-T-33	Tube projectile (33mm) (Pkg 40)	40
FT1355-A-33	ABRASIVE (33mm) (Pkg 40)	40	FT1355-H-45	Low density hose projectile (45mm) (Pkg 20)	20	FT1355-T-36	Tube projectile (36mm) (Pkg 30)	30
FT1355-A-36	ABRASIVE (36mm) (Pkg 30)	30	FT1355-H-50	Low density hose projectile (50mm) (Pkg 20)	20	FT1355-T-40	Tube projectile (40mm) (Pkg 30)	30
FT1355-A-40	ABRASIVE (40mm) (Pkg 30)	30	FT1355-H-55	Low density hose projectile (55mm) (Pkg 15)	15	FT1355-T-45	Tube projectile (45mm) (Pkg 20)	20
FT1355-A-45	ABRASIVE (45mm) (Pkg 20)	20	FT1355-H-60	Low density hose projectile (55mm) (Pkg 15)	15	FT1355-T-50	Tube projectile (50mm) (Pkg 20)	20
FT1355-A-50	ABRASIVE (50mm) (Pkg 20)	20	FT1355-H-65	Low density hose projectile (60mm) (Pkg 15)	15	FT1355-T-55	Tube projectile (55mm) (Pkg 15)	15
FT1355-A-55	ABRASIVE (55mm) (Pkg 15)	15	FT1355-H-70	Low density hose projectile (65mm) (Pkg 10)	10	FT1355-T-60	Tube projectile (60mm) (Pkg 15)	15
FT1355-A-60	ABRASIVE (60mm) (Pkg 15)	15	FT1355-H-75	Low density hose projectile (70mm) (Pkg 10)	10			
FT1355-H-05	Low density hose projectile (05mm) (Pkg 100)	100	FT1355-H-80	Low density hose projectile (80mm) (Pkg 10)	10			
FT1355-H-06	Low density hose projectile (06mm) (Pkg 100)	100	FT1355-H-85	Low density hose projectile (85mm) (Pkg 10)	10			
FT1355-H-07	Low density hose projectile (07mm) (Pkg 100)	100	FT1355-H-90	Low density hose projectile (90mm) (Pkg 10)	10			
FT1355-H-08	Low density hose projectile (08mm) (Pkg 100)	100	FT1355-H-95	Low density hose projectile (95mm) (Pkg 10)	10			
FT1355-H-10	Low density hose projectile (10mm) (Pkg 100)	100	FT1355-H-100	Low density hose projectile (100mm) (Pkg 10)	10			
FT1355-H-100	Low density hose projectile (100mm) (Pkg 100)	100	FT1355-T-06	Tube projectile (06mm) (Pkg 100)	100			

Assembly equipment

Contamination control products

L

FT1355 Series

Cleaning projectile selection ordering guidelines

Order quantity is one bag
(ex. A 1 piece order will be for the full bag quantity noted below)

FT1355 foam projectile part #’s for FT1455 projectile launchers	Order quantity is one bag .(ex.. A 1 piece order will be for the full bag quantity noted below)	Inner Diameter (ID) in inches of cut hose, and Hose assembly Dash size	FT1355 foam projectile part #’s for FT1455 projectile launchers	Order quantity is one bag .(ex.. A 1 piece order will be for the full bag quantity noted below)	Inner Diameter (ID) in inches of cut hose, and Hose assembly Dash size
FT1355-H-06	100	3/16" (-03)	FT1355-H-33 (or)	40	1" (-16)
FT1355-H-10 (or)	100	1/4" (-04)	FT1355-H-36*	30	
FT1355-H-12*	100		FT1355-H-40	30	1 1/4" (-20)
FT1355-H-12 (or)	100		FT1355-H-45*	20	
FT1355-H-14*	100	5/16" (-05)	FT1355-H-50 (or)	20	1 1/2" (-24)
FT1355-H-14 (or)	100		FT1355-H-55*	15	
FT1355-H-16*	100	3/8" (-06)	FT1355-H-60 (or)	15	2" (-32)
FT1355-H-18 (or)	100		FT1355-H-65*	10	
FT1355-H-20*	50	1/2" (-08)	FT1355-H-75	10	2 1/2" (-40)
FT1355-H-22	50	5/8" (-10)	FT1355-H-85	10	3" (-48)
FT1355-H-26	50	3/4" (-12)	FT1355-H-100	10	3 1/2" (-64)

Note: * Use the larger projectile size for maximum cleaning on hose cut with an abrasive wheel

FT1555 CapSeal System



FT1555 Series CapSeal system

The FT1555 CapSeal system is intended to be used in conjunction with the FT1355 and FT1455 series projectile cleaning systems to prevent recontamination of hose, tube, and pipe assemblies. The FT1555 CapSeal system utilizes heat shrink technology to encapsulate the end of a hose or tube assembly with an FT1555 CapSeal capsule.

Features

- Provides industry leading ISO cleanliness levels
- Robust construction for use in heavy duty applications
- Available in hand-held and bench-mount configurations
- Ideal for portable small volume applications, and large volume production applications
- Optimum CapSeal capsule design to meet a broad variety of applications
- Minimal setup
- Capability: 1/4" to 2" ID hose and fitting ends
- Available in kits or individual replacement hardware components
- Kits available with and without projectiles

Typical applications

Hydraulics	<ul style="list-style-type: none"> • Removes rubber dust and metal particles from the hydraulic hose cutting process • Removes metal flash from the crimping process on hose and tubes • Removal of contaminated oil from hoses, tubes and pipes in hydraulic systems
Pneumatics	<ul style="list-style-type: none"> • Eliminates rubber contamination, metal particles, contaminated oil and moisture that causes breakdowns and inefficiency
Heat exchangers and condenser	<ul style="list-style-type: none"> • Eliminates contamination that reduces heat transfer resulting in low level performance
Steam boilers	<ul style="list-style-type: none"> • Removes most scaling in steam pipes for maintenance servicing
Air conditioning and refrigeration	<ul style="list-style-type: none"> • Eliminates minute particles in copper tubes and coolant lines that affect system performance
Oxygen and gas	<ul style="list-style-type: none"> • Eliminates oil, grease and other contaminants from copper or S/S tubing
Oil, gas and chemical processing	<ul style="list-style-type: none"> • Efficient cleaning of pipes as part of service maintenance
Earthmoving equipment	<ul style="list-style-type: none"> • Maintenance reduction in flushing time and filter usage
Automotive and servicing	<ul style="list-style-type: none"> • Cleaning of fuel lines and brake lines prior to assembly and servicing of components
Food and beverage	<ul style="list-style-type: none"> • Product recovery retrieval of product from lines. Reducing or eliminating solvents or detergents
Gun barrels	<ul style="list-style-type: none"> • To remove rust, scale or powder residue much faster than brushing or swabbing

Assembly equipment

Contamination control products

L

FT1555 CapSeal System

Hardware

FT1555-HH



Hand held electric heat gun

- Variable temperature electronic heat gun with electronic thermocouple control
 - Duratherm heating element ensure long life and even heat temperature range of 120°F (49°C) to 1100°F (593°C) and a built-in cool down switch
 - Case not included
- Capable of sealing multiple hoses simultaneously
 - Additional nozzle attachments included for other heat shrinking applications
 - Operates on 120V AC power, draws 1500 watts, and can produce 17.6CFM

FT1555-BM



Bench mount production heat shrink machine

- Industrial production ready - brushless heat source with robust thermal insulation for 24/7 continuous operation capability
 - Enables sealing of single or multiple hose or tube assemblies at one time
 - White plunger provides solid surface for holding CapSeal capsules for uniform heat distribution during heat shrinking
- Dedicated air filter prevents airborne contamination during sealing
 - Hot air blower timer allows for optimum cycle time depending on hose or tube ends being sealed
 - Accepts CapSeal capsules from 3/4" (20mm) ID to 3" (80mm) ID and allows sealing and thread protection for most hose and tube ends from -4 (1/4") through -32 (2")
 - Operates on 230V single-phase AC power at 50/60Hz and draws < 10 amps
 - Please note that a L6-15 NEMA twist loc receptacle (not supplied) is required for operation

FT1555 CapSeal System Kits

FT1555-HH-K1



Hand held electric heat gun basic kit

(up to 1-1/2" hose ID and tube ends)

- Capability – for use with 1/8" through 1-1/2" hose ID or tube ends
- Form factor – Hand-held, portable – ideal for harsh environments and heavy use
- Typical applications – Mobile hose fabricators and mobile applications
- Case not included

FT1555-HH-K1 kit includes

- FT1555-HH hand held electric heat gun with carrying case
- FT1555-HH-ST flex vacuum pump stand for hand held electric heat gun
- FT1555-HH-D15 1-1/2" diffuser for hand held electric heat gun

FT1555-HH-K2



Hand held electric heat gun starter kit

(up to 1-1/2" hose ID and tube ends)

- Capability – For use with 1/8" through 1-1/2" hose ID or tube ends
- Form factor – Hand-held, portable – ideal for harsh environments and heavy use
- Typical applications – Mobile hose fabricators and mobile applications
- Case not included

FT1555-HH-K2 kit includes in addition to contents of FT1555-HH-K1 kit

- FT1555-2540UP CapSeal Capsules 25mm x 40mm (ID x LENGTH)
- FT1555-2840UP CapSeal Capsules 28mm x 40mm (ID x LENGTH)
- FT1555-3140UP CapSeal Capsules 31mm x 40mm (ID x LENGTH)
- FT1555-3440UP CapSeal Capsules 34mm x 40mm (ID x LENGTH)
- FT1555-3840UP CapSeal Capsules 38mm x 40mm (ID x LENGTH)
- FT1555-4650UP CapSeal Capsules 46mm x 50mm (ID x LENGTH)

FT1555-HH-K3



Hand held electric heat gun premium starter kit

(up to 1-1/2" hose ID and tube ends)

- Capability – For use with 1/8" through 1-1/2" hose ID or tube ends
- Form factor – Hand-held, portable – ideal for harsh environments and heavy use
- Typical applications – Mobile hose fabricators and mobile applications
- Case not included

FT1555-HH-K3 kit includes in addition to contents of FT1555-HH-K1 kit

- FT1555-2023UP CapSeal Capsules 20mm x 23mm (ID x LENGTH)
- FT1555-2540UP CapSeal Capsules 25mm x 40mm (ID x LENGTH)
- FT1555-2840UP CapSeal Capsules 28mm x 40mm (ID x LENGTH)
- FT1555-3140UP CapSeal Capsules 31mm x 40mm (ID x LENGTH)
- FT1555-3440UP CapSeal Capsules 34mm x 40mm (ID x LENGTH)
- FT1555-3840UP CapSeal Capsules 38mm x 40mm (ID x LENGTH)
- FT1555-4650UP CapSeal Capsules 46mm x 50mm (ID x LENGTH)
- FT1555-5260UP CapSeal Capsules 52mm x 60mm (ID x LENGTH)
- FT1555-5860UP CapSeal Capsules 58mm x 60mm (ID x LENGTH)
- FT1555-6760UP CapSeal Capsules 67mm x 60mm (ID x LENGTH)
- FT1555-8060UP CapSeal Capsules 80mm x 60mm (ID x LENGTH)

Assembly equipment

Contamination control products

L

FT1555 CapSeal System

Capsules

FT1555 CapSeal capsules eliminate contamination by forming a clean and secure seal around hose and tube ends. FT1555 CapSeal system eliminates the need to stock multiple plastic threaded caps with just 16 CapSeal capsule sizes to meet all type of hose and tube end configurations.

Additionally, the quick and easy pull-off tab on each capsule eliminates the need for additional tools that could further contaminate the assemblies.

FT1555 CapSeal capsules are available in 16 sizes of varying diameter and length to match needs of all assemblies, and are available in both unit packaged and bulk packaged packaging.

Unit packaged CapSeal packages		Bulk packaged CapSeal packages		CapSeal capsule size		Hex sizes covered		Fitting	
CapSeal part #	Packaged quantity	CapSeal part #	Packaged quantity	(mm, ID X length)	(mm)	(Inches)	Straight	Elbow*	
FT1555-2023UP	810	FT1555-2023BP	23,400	20 X 23	12mm to 18mm	0.47" to 0.71"		X	
FT1555-2030UP	810	FT1555-2030BP	23,400	20 X 30	12mm to 18mm	0.47" to 0.71"	X		
FT1555-2224UP	810	FT1555-2224BP	22,500	22 X 24	16mm to 21mm	0.63" to 0.63"		X	
FT1555-2527UP	800	FT1555-2527BP	17,600	25 X 27	18mm to 23mm	0.71 to 0.91"		X	
FT1555-2540UP	800	FT1555-2540BP	17,600	25 X 40	18mm to 23mm	0.71" to 0.91"	X		
FT1555-2840UP	720	FT1555-2840BP	15,200	28 X 40	22mm to 26mm	0.87" to 1.02"	X		
FT1555-3133UP	640	FT1555-3133BP	12,240	31 X 33	24mm to 29mm	0.94" to 1.14"		X	
FT1555-3140UP	640	FT1555-3140BP	12,240	31 X 40	24mm to 29mm	0.95" to 1.14"	X		
FT1555-3440UP	640	FT1555-3440BP	10,240	34 X 40	27mm to 32mm	1.07" to 1.26"	X		
FT1555-3840UP	560	FT1555-3840BP	7,800	38 X 40	30mm to 36mm	1.19" to 1.42"	X	X	
FT1555-4345UP	480	FT1555-4345BP	6,240	43 X 45	32mm to 41mm	1.26" to 1.61"	X	X	
FT1555-4650UP	480	FT1555-4650BP	5,760	46 X 50	34mm to 44mm	1.34" to 1.73"	X	X	
FT1555-5260UP	400	FT1555-5260BP	4,400	52 X 60	41mm to 50mm	1.62" to 1.97"	X	X	
FT1555-5860UP	400	FT1555-5860BP	3,600	58 X 60	49mm to 56mm	1.93" to 2.20"	X	X	
FT1555-6760UP	320	FT1555-6760BP	2,560	67 X 60	55mm to 65mm	2.16" to 2.56"	X	X	
FT1555-8060UP	320	FT1555-8060BP	1,736	80 X 60	64mm to 78mm	2.52" to 3.07"	X	X	

* Shorter length CapSeal capsules are recommended for elbow and angled fittings (45° and 90°)

FT1555 CapSeal System

Accessories



FT1555-HH-D15

1-1/2" Diffuser for FT1555-HH hand held electric heat gun

- Even 360° heat diffusion to shrink CapSeal capsules fitting configurations
- Accommodates all CapSeal capsules up to 1-1/2"



FT1555-HH-D20

2" Diffuser for FT1555-HH hand held electric heat gun

- Even 360° heat diffusion to shrink CapSeal capsules
- Accommodates all CapSeal capsules up to 2"
- Stainless steel construction for superior service life



FT1555-HH-ST

Flexible stand for FT1555-HH hand held electric heat gun

- Convenient carrying case to store and carry the hand held projectile launchers and relevant nozzles
- Works with all 3 models of hand held projectile launchers



E-EOCR-TT006-E

Operating Instructions for FT1555-BM Bench Mount Capping Machine

Cabinets

C-40X

Stock cabinet



Ideal for mounting the T-400-1 Coll-O-Crimp I press and pump or T-420-1 Coll-O-Crimp Super I. The sturdy C-40X cabinet contains 40 heavy-duty plastic drawers that can be divided into one, two, three, or four compartments providing space for a large selection of Coll-O-Crimp hose ends and adapters.

Drawers

PD-40 (one drawer)

Dividers

PD-20 (individual)

Size

46-1/2" high, 40" wide,
26" deep at base,
18" deep at top

Weight

228 lbs.

FH-135X

Stock cabinet



The sturdy FH-135X cabinet contains 50 heavy-duty plastic drawers that can be divided into one, two, or three compartments allowing you ample space for a large selection of Coll-O-Crimp hose ends and adapters. Ideal for mounting the Coll-O-Crimp I Press and Pump.

Drawers

PD-95 (one drawer)

Dividers

PD-15 (individual)

Size

46-1/2" high, 33" wide, 14-1/2" deep

Weight

115 lbs.

FH-15X

Stock cabinet



Here is the ideal way to organize your inventory of hose ends and adapters. The rugged FH-15X cabinet contains 15 plastic drawers for stocking hose ends and adapters.

Drawers

PD-95 (one drawer)

Dividers (individual)

PD-15

Size

13-5/8" high, 14-3/8" deep,
30-1/4" wide

Weight

45 lbs.

FH-40X

Stock cabinet



Provides convenient storage areas for those large size fittings and hose ends. This durable 20 gauge steel cabinet is made to handle abuse.

Size

35" wide, 42" high, 12" deep

Weight

200 lbs.

Note: Will not support Weatherhead Coll-O-Crimp equipment.

Assembly equipment

Cabinets and assortments

L

Cabinets

FH-72X

Stock cabinet

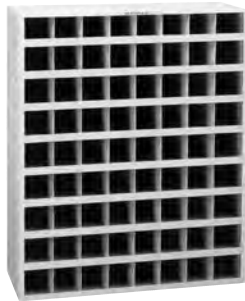

Large capacity all-welded cabinet provides 72 storage compartments. Fabricated from 20 gauge steel, the FH-72X will provide years of continued service.

Size
35" wide, 42" high, 12" deep

Weight
200 lbs.

Note: Will not support Weatherhead Coll-O-Crimp equipment.

C-5X

Stock cabinet



This mini-cabinet is designed to contain your oversized Weatherhead hose ends which may not currently have an organized home.

Size
30" wide, 5-7/8" high, 9-5/16" deep

Weight
10 lbs.

TC-20

Collet cabinet



The TC-20 Cabinet provides you easy access to all of your tooling needs. There is ample space for collets, spacer rings, and related Coll-O-Crimp tooling.

Size
28-1/2" high, 26-1/2" wide, 12-3/4" deep

Weight
37-1/2 lbs.

HD-1X

Hose cabinet



The HD-1X Cabinet offers you the ideal solution for keeping 50 foot lengths of hose off your floor. Vertical slots in the cabinet keep your hoses organized and clean. Consider bolting an FH-15X stocking cabinet on top of the HD-1X to keep an inventory of hose ends readily available.

Size
36" high, 24" deep, 31" wide

Weight
83 lbs.

HD-2X

Hose center display



The HD-2X hose display is built with a heavy steel inner frame which supports the weight of the hose reels, while its tough wooden sides provide additional durability. It is designed to hold both Weatherhead bulk reels and boxed product. Handles are even provided to make loading the hose as safe and easy as possible.

Measurements

22" wide x 30" deep x 57" tall

Weight

54 lbs. (UPS Shipping)

Maximum capabilities

(3) Reels or (2) Reels & (4) Boxes

(Hose not included)

Assortments

AB-9

Air brake air chamber hose



Assembly assortment of 3/8" I.D. lines

Each selection of fourteen ready-made air chamber hose assemblies facilitate replacement of hoses. Eliminates time and cost of making special assemblies. Wall rack keeps assemblies handy and ready to use.

Length	Quantity	Part number
18-1/2"	1	38166-01812
20-3/8"	2	38166-02137
24-1/8"	2	38166-02412
28-3/8"	2	38166-02837
30-1/8"	2	38166-03012
32"	1	38166-03200
34-3/8"	1	38166-03437
36-1/8"	2	38166-03612
41-1/8"	1	38166-04112
	1	AB-9X (rack only)

Replacement Labels: AB-9L

FL-310

Fuel hose and fittings assortment



FL-310 contains 250' of Weatherhead fuel line hose, a variety of brass hose end fittings, and gear-type clamps for easy, instant service on fuel and oil line assemblies.

A well-designed cabinet keeps 1/4", 5/16", or 3/8" I.D. hose on reels free of kinks and tangles ready for instant use. Ten clear plastic drawers with color-coded illustrated labels are provided for storing hose end fittings and clamps. H057 hose is compatible with unleaded gasolines and low pressure fuel systems.

Size

30" wide, 13-1/2" high, 13" deep

WARNING: California Proposition 65, see A-2.

Part number	Quantity	Part number	Quantity
05704B-102	10	05706B-1568	5
05704B-104	5	05706B-1570	5
05704B-C02	5	05706B-C02	5
05705B-102	10	05706B-C04	5
05705B-104	10	6205-004	20
05705B-1560	5	FL-310X	1
05705B-1561	5	H05704	100'
05705B-C02	5	H05705	100'
05705B-C04	5	H05706	50'
05706B-102	10		
05706B-104	10		
05706B-106	5		

Assembly equipment

Cabinets and assortments

Assortments

FF12139

E-Z Clip System



The E-Z Clip System is designed for assembly with weatherhead multi-refrigerant hose GH001. It's engineered connection exceeds SAE J2064 and has been vibration and impulse tested.

Note: The E-Z Clip System has been designed to work exclusively with Weatherhead GH001 Hose.

Kit contents components

Part number	Description	Qty/per kit
1F40104-size	Clips	20 each size
1F40105-size	Cages	10 each size
FT1357	Assy. tool	1
T-135	Hose cutter	1
T-135B	Replacement blade	1

BL-456

Barb-Tite fittings and hose assortment



Making up an air line oil line transmission, or power steering return line?

The BL-456 assortment puts Eaton Barb-Tite fittings and 1/4", 5/16", and 3/8" I.D. 350 psi maximum operating pressure H101 hose at your fingertips for quick and easy assembly. Simply push ends on hose, and you have a hose assembly. No clamps required!

Measure the hose on top of the cabinet with the rule provided and then select the proper hose ends from the assortment in the two metal drawers. Within minutes the hose assembly is ready for installation.

Size

15" wide, 16-1/2" high, 13-3/16" deep
16 compartments in each drawer.

Part number	Qty.	Part number	Qty.	Part number	Qty.	Part number	Qty.
10004B-102	4	10004B-B04	4	10005B-C02	4	10006B-606	4
10004B-104	4	10004B-B05	4	10005B-C04	4	10006B-B06	4
10004B-304	4	10004B-Y04	4	10005B-Y05	4	10006B-Y06	4
10004B-305	4	10005B-102	4	10006B-102	4	H10104	25'
10004B-605	4	10005B-104	4	10006B-104	4	H10105	25'
10004B-604	4	10005B-605	4	10006B-106	4	H10106	25'
10004B-A04	4	10005B-B05	4	10006B-306	4	FS-500	1
10004B-A05	4	10005B-B06	4	10006B-406	4	BL-456X	1
10004B-B03	4						

Assortments

FT1341

Thread measuring kit



Measuring tube and pipe fitting threads can be a most difficult task if not completely understood. Tools needed include a thread pitch gauge, calipers and seat angle gauges. To aid you, Eaton has a kit to fit your needs; the FT1341 thread measuring kit.

This handy kit includes:

- Thread pitch gauge (Imperial and metric)
- Inside/outside caliper (inches and millimeters)
- 2 seat angle gauges (37°/45° and a 12°/30°)
- How to identify fluid ports and connectors bulletin
- Carrying case for easy convenient and storage

Weight: .5 lb.

TA-1004

Metric thread identification kit

Contained in a durable steel carrying case, TA-1004 will help you with identification of metric, British pipe, and JIS thread configurations. Identification pieces are configured for 20 metric and 8 British pipe sizes.

This handy kit includes:

- Steel carrying case
- Stainless steel caliper
- Metric and British thread pitch gauges
- British thread measuring templates (4 measuring 8 sizes) made of durable aircraft grade aluminum
- Metric Thread Measuring Templates (10 measuring 20 sizes) made of durable aircraft grade aluminum
- Kit content identification chart

Assembly equipment

Cabinets and assortments

Assortments

SS-85

Standard brass fittings assortment



Instant service for service stations, car dealers, and repair shops. Contains 85 of the fastest moving Weatherhead brass fittings.

Compact, lightweight plastic box stores easily in a drawer, shelf or service truck. Saves you time and money by having the right fitting when it is needed. Eliminates searching and make-shift repairs by giving you the right part when you need it most.

Size

11" wide, 1-3/4" high, 6-3/4" deep.

Weight

3-1/4 lbs.

Part Number	Qty.
105x3	5
105x4	5
105x5	10
202x4	5
202x5	5
3151x2	2
3220x4x2	5
3300x2	5
402x4	2
60x3	5
60x4	10

Part Number	Qty.
60x5	5
60x6	5
62x3	2
62x4	5
62x5	5
62x6	2
68x4	2
BF-40X	1

WARNING: California Proposition 65, see A-2.

SS-86

Compression fittings assortment



Assortment contains 80 of the fastest moving compression fittings.

Size

11" wide, 1-3/4" high, 6-3/4" deep.

Weight

3-1/2 lbs.

Part Number	Qty.
60x3	5
60x4	10
60x5	5
60x6	5
61x3	5
61x4	5
61x5	5
61x6	5
62x3	5

Part Number	Qty.
62x4	5
62x5	5
62x6	2
68x3	2
68x4	5
68x5	2
69x3	2
69x4	5
69x5	2
BF-40X	1

SS-87

Inverted flare fittings assortment



Assortment contains 84 of the fastest moving inverted fittings.

Size

11" wide, 1-3/4" high, 6-3/4" deep.

Weight

3-1/2 lbs.

Part Number	Qty.
105x3	5
105x4	5
105x5	5
105x6	5
202x3	5
202x4	5
202x5	5
202x6	2
302x3	5

Part Number	Qty.
302x4	5
302x5	5
302x6	2
402x3	5
402x4	5
402x5	5
402x6	5
7896x3	5
7896x4	5
BF-40X	1

Assortments

SS-88

Brass pipe assortment



Assortment contains 59 of the fastest moving brass pipe fittings.

Size

11" wide, 1-3/4" high, 6-3/4" deep.

Weight

3-1/2 lbs.

WARNING: California Proposition 65, see A-2.

Part number	Qty.
3152x2	5
3152x4	5
3152x6	2
3220x4x2	2
3220x6x4	2
3300x2	5
3300x4	2
3326x2	5
3326x4	5

Part number	Qty.
3326x6	2
3350x2	5
3350x4	4
3350x6	2
3400x2	5
3400x4	2
3400x6	2
3500x2	2
3500x4	2
BF-40X	1

BF-40

Hydraulic brake fittings assortment



The BF-40 assortment of fast moving hydraulic brake fittings is a must for any shop doing brake service work. Contains the adapters needed to convert large size ports in master cylinders to accept standard steel brake lines plus the brass tees used in the installation of electric towed trailer brakes.

Assortment is organized in a compact, handy plastic box for easy selection.

Size

1" wide, 1-3/4" high, 6-3/4" deep.

Weight

4 lbs. (approx.)

Part number	Qty.
7818	2
7828	2
7829	2
7897	2
7898	2
7900	2
7901	2
7904	2
7905	2

Part number	Qty.
7906	2
7908	2
7910	2
7911	2
7912	2
7913	2
7914	2
7917	2
7933	2
BF-40X	1

BF-41

Hydraulic brake line adapter assortment



The BF-41 assortment contains the adapters needed to convert the oversize master cylinder ports to accept the inverted flare nut used on standard replacement steel brake lines.

The adapters eliminate the need to cut line, install oversize nut and double flare tubing as well as converting the port to standard size threads for the life of the car. Extra standard nuts and the unions needed to connect two steel brake lines when a non-standard length is required are also included in the assortment. The contents including the illustrations of parts are shown on the inside cover of the box.

Size

11" wide, 1-3/4" high, 6-3/4" deep.

Weight

4 lbs. (approx.)

Part number	Qty.
105x3	10
105x4	10
105x5	10
105x6	5
105x6x7	2
302x3	5
302x4	5
302x5	5
302x6	2

Part number	Qty.
7818	2
7828	2
7829	2
7896x3	5
7896x4	5
7897	2
7908	2
7917	2
BF-40X	1

Assembly equipment

Cabinets and assortments

L

Assortments

AB-140

1400 Series air brake fittings assortment



This assortment of 1/4", 3/8", and 1/2" air brake fittings designed for use with NT100 nylon air brake tubing provides the coverage needed for service work by fleets, repair shops, and farm implement dealers. The DOT-approved air brake fittings are easily selected from the cabinet with 16 plastic drawers and color-coded labels included in the assortment.

Part Number	Qty.	Part Number	Qty.
1460x4	20	1469x8	5
1460x6	20	1484x4	20
1460x8	20	1484x6	20
1461x4	10	1484x8	20
1461x6	10	145	10
1461x8	5	CL-16-3	1
1462x4	5	FC-16X	1
1462x6	10	W15310	5
1462x8	4		
1468x4	10		
1468x6	10		
1468x8	5		
1469x4	5		
1469x6	5		

Quick connect assortments

QC-18



Designed as a glove box sized emergency repair kit, the QC-18 assortment contains Q-CAB tube unions in 5/32", 1/4", 3/8", and 1/2" sizes, also included is a T-191 tubing cutter. The contents are contained in a convenient carrying case measuring 1-1/4" x 3-3/4" x 7".

Component part no.	Qty.
1862x2.5	2
1862x4	2
1862x6	2
1862x8	2
T-191	1
QC-18X	1

QC-180



The QC180 contains tube unions, male connectors, swivel male 45° elbow, male 90° elbows, and repair kits in popular 1/4", 3/8", and 1/2" tube sizes designed for DOT Truck and Trailer Air Brake System needs (see complete listing at right in table). The Q-CAB fittings are field proven with over millions of miles of leak free performance. Their design can save up to 75 percent of the assembly time over conventional compression fittings. These fittings are contained in a case measuring 1-3/4" x 6-3/4" x 1-3/4".

Component part no.	Qty.
1869x6x6	2
1862x4	2
1869x8x8	1
1862x6	2
1880x4x4	2
1862x8	2
1880x6x6	2
1868x2.5	2
1880x8x8	1
1868x3	2
1800Kx4	2
1868x4x4	2
1800Kx6	2

Component part no.	Qty.
1868x6x6	2
1800Kx8	2
1868x8x8	2
1800TRK	1
1869x4x4	2
BF-40X	1

QC-1800



This assortment contains a solid inventory of popular Weatherhead Q-CAB fittings designed for DOT Truck and Trailer Air Brake System needs (see complete listing at right in table). The Q-CAB fittings are field proven with over millions of of leak free performance. Their design can save up to 75 percent of the assembly time over conventional compression fittings.

Component part no.	Qty.
1800Kx2.5	4
1862x10	2
1868x12	2
1874x6x6	1
1800Kx3	4
1868x2.5x1	5
1869x4	5
1874x8x8	1
1800Kx4	4
1868x2.5	5
1869x4x4	5
1880x4x4	5
1800Kx6	4
1868x3	5
1869x6	5
1880x6x6	5
1800Kx8	4
1868x4	5
1869x8	5
1880x8x8	5
1800Kx10	2
1868x4x4	5
1869x8x8	5
1880x10	2

Component part no.	Qty.
1800Kx12	2
1868x6	5
1869x10	2
1880x12	2
1862x2.5	2
1868x6x6	5
1869x4S	5
1800-T	1
1862x3	5
1868x8	5
1869x4x4S	5
CL-503	1
1862x4	5
1868x8x8	5
1869x6S	5
FC-16X	1
1862x6	5
1868x10x6	2
1869x8S	5
T-191	1
1862x8	5
1868x10	2
1874x4x4	1

Assembly equipment

Cabinets and assortments

Assortments

SA-1

Secondary air systems kit



Ideal for fleet repair shops, truck dealers, garages and truck stops. SA-1 contains an assortment of popular 1/8" and 1/4" brass fittings plus 200' of Weatherhead NT100 SAE J844 nylon tubing. The 1/8" fittings are Weatherhead SELFALIGN and 1/4" fittings are Weatherhead 1400 series air brake.

The sturdy box keeps the tubing and fittings together for quick and easy servicing of the tubing used on shifters, PTO's, wipers, horns, remote air, instrumentation, etc. All of the parts are organized at your finger tips. The SA-1 is a must for all vehicle air system maintenance facilities.

WARNING: California Proposition 65, see A-2.

Size
15" wide, 3-1/2" high, 14-1/2" deep.

Part Number	Qty.
1460x4	10
1461x4	5
1462x4	2
1464x4	1
1468x4	2
1468x4x1	2
1468x4x4	2
1469x4	2
1469x4x4	2
1484x4	5

Part Number	Qty.
601x2	10
611x2	5
621x2	2
661x2	2
681x2	2
681x2x1	2
691x2	2
691x2x1	2
BF-40X	1

SA-2

Secondary air systems kit



The SA-2 assortment enables you to supply fleets and dealers with fittings and tubing for 1/4" and 3/8" O.D. air brake applications. 1/8" O.D. tubing and fittings are also supplied for applications such as transmission shifter, air horn, gauge and flat adjustment. A cabinet is also supplied for easy storage on shelves and bench tops.

Part Number	Qty.
1460x4	10
1460x6	20
1461x4	5
1461x6	10
1462x4	5
1462x6	10
1464x4	2
1464x6	2
1466x6	5
1468x4	5
1468x4x4	5
1468x4x6	2
1472x4	5
1472x6	5
1472x6x6x6	5
1484x4	10
1484x6	10
1485x4	10
1485x6	10

Part Number	Qty.
1468x6	10
1468x6x2	5
1468x6x6	5
1468x6x8	5
1469x4	5
1469x4x4	5
1469x6	10
1469x6x6	5
601x2	10
611x2	10
621x2	5
661x2	5
681x2	5
681x2x1	2
691x2	5
691x2x1	2
BL-456-X	1
FS-SA-2	1

Bags

PB Plastic bags



Weatherhead heavy duty plastic bags for Weatherhead fittings come in sizes 5"x6", 6"x10", and 8"x12". The bags include convenient spaces for labeling.

Catalog number	Description	Qty
5x6 PB	Plastic Bag	100
6x10 PB	Plastic Bag	100
8x12 PB	Plastic Bag	100

Assembly equipment

Cabinets and assortments

Label sets

Self-adhesive label sets



For C-40X, FH-15X, and FH-135X cabinets

Label number	Description
FS-100	SAE 37° adapters
FS-200	NPTF adapters
FS-300	ORS & ORB adapters
FS-400	Field attachable hose ends – 009 'B' series
FS-500	Barb-Tite 100 'B' and 105 'B' series hose ends
FS-600	Field attachable hose ends – 069 'D' & 247 'N' series
FS-700	Field attachable hose ends – 425 'N' series
FS-800	Field attachable hose ends – 338 'B' series & brass
FS-1200	Coll-O-Crimp hose ends – 'E' series
FS-1500	Coll-O-Crimp hose ends – 069 'E' series
FS-1600	7000 Series flareless fitting
FS-2000	Steel pipe
FS-2300	Drain cocks, valves and select 338 'B' series hose ends
FS-2400	ORS adapters label set
FS-2800	Field attachable hose ends – 213 'N' series
FS-2900	Coll-O-Crimp hose ends – 338 'P' series
FS-3200	Coll-O-Crimp hose ends – 757 'E' series
FS-3300	Quick connect air brake 1800 series
FF90645	'Z' series label set
FF90646	E-Z Clip label set
FF91420	4S/6S Hose ends label set

A2103

Mylar hose labels



Eaton now offers Mylar labels for marking hose assemblies. They are self-adhesive Mylar strips, 1" wide by 3-3/4" long, with a 1" x 1" white area on one end for printed information. They are supplied on a roll of 2000 labels with each perforated page containing eight labels. The format is suitable for use in typewriters and tractor-feed or friction-drive printers.

Whether for compliance with federal hose assembly labeling requirements, or for simply meeting customer demands for labeling hose assemblies, we strongly recommend labeling become part of your hose assembly "manufacturing" procedure. The National Highway Traffic Safety Administration places responsibility for labeling an air brake hose assembly in the hands of the "manufacturer" of the hose assembly. (Not the manufacturer of the hose or hose ends.) For a summary of air brake hose assembly labeling recommendations, see "Air Brake Hose Assembly Guidelines."

For specific air brake hose assembly regulations, consult "Federal Motor Vehicle Safety Standard (FMVSS) 571.106," available from NHTSA, at the address listed below. For use other than air brake applications, customers may want additional information on the labels. Generally, the labels will accept 9-10 characters per row, on 4 or 5 rows. The information can be handwritten, typed, or printed on the labels. The main concern is resistance to the elements. Procedure for applying the labels is simple:

1. Print the appropriate information on the label.
2. Wrap the tag around the hose assembly; printed end first.
3. Cover the printed end with the clear mylar tail of the label.
4. The clear tail will protect the printed area from the elements.

Office of Vehicle Safety Standards
 National Highway Traffic Safety Administration
 400 Seventh Street SW
 Washington, DC 20590
 Phone (202) 366-5317
www.nhtsa.dot.gov

Glossary and index

Glossary M-2
Index M-6

M

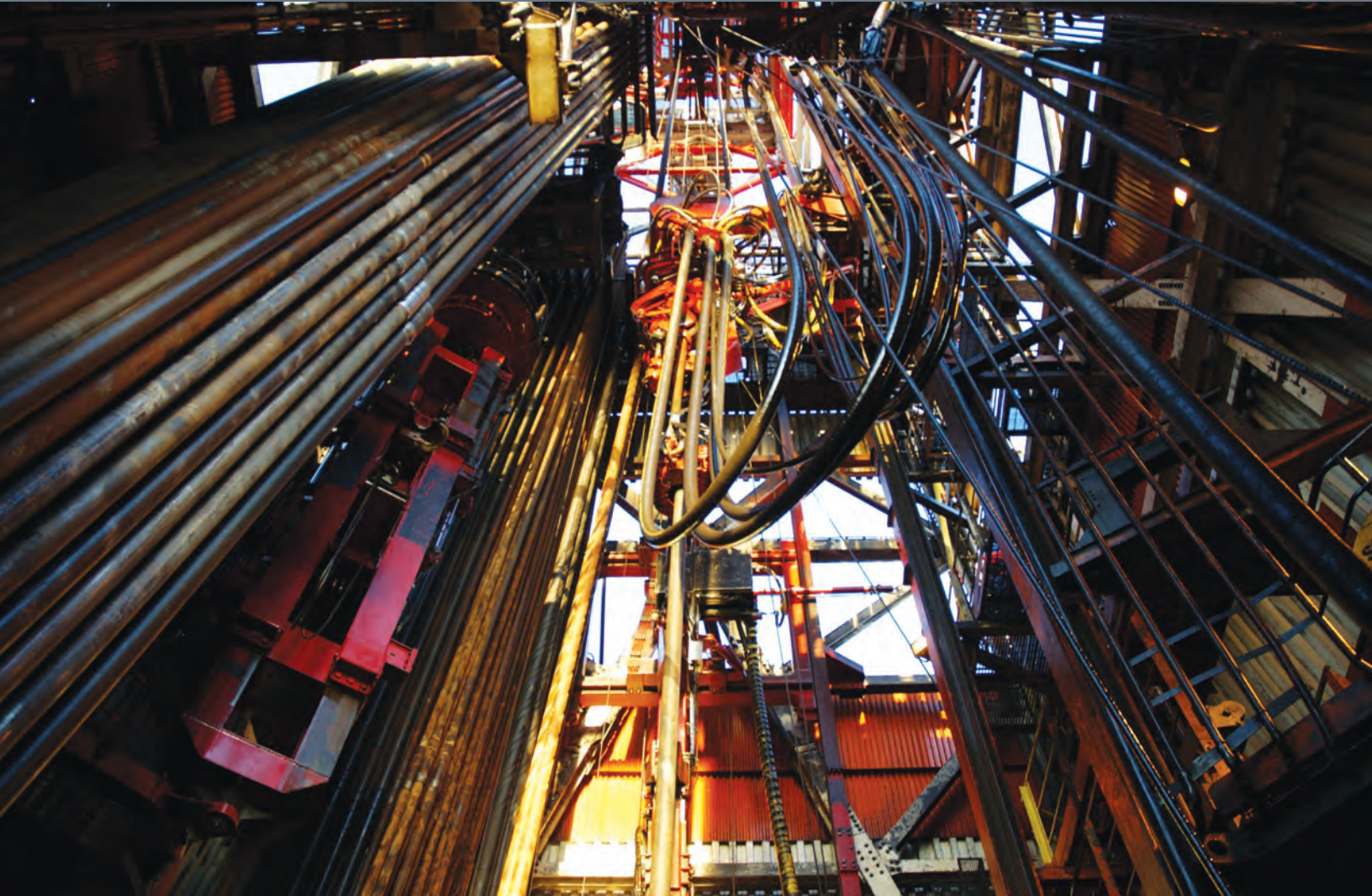

A

abrasion: external damage to a hose assembly caused by its being rubbed on a foreign object; a wearing away by friction.

ABS: American Bureau of Shipping

acid resistant: having the ability to withstand the action of identified acids within specified limits of concentration and temperature

adapter, adaptor: fittings of various sizes and materials used to change an end fitting from one type to another type or one size to another.

adhesion: the strength of bond between cured rubber surfaces or between a cured rubber surface and a non-rubber surface.

adhesive: a material which, when applied, will cause two surfaces to adhere.

ambient temperature: the temperature of the atmosphere or medium surrounding an object under consideration.

ambient/atmospheric conditions: The surrounding conditions, such as temperature, pressure, and corrosion, to which a hose assembly is exposed.

amplitude of vibrations and/or lateral movement: the distance a hose assembly deflects laterally to one side from its normal position, when this deflection occurs on both sides of the normal hose centerline.

anchor: a restraint applied to eliminate motion and restrain forces.

annular: refers to the convolutions on a hose that are a series of complete circles or rings located at right angles to the longitudinal axis of the hose (sometimes referred to as "bellows").

anodize, anodized: an electrolytic process used to deposit protective or cosmetic coatings in a variety of colors on metal; primarily used with aluminum.

ANSI: American National Standards Institute.

application working pressure: unique to customer's application. See pressure, working.

application: the service conditions that determine how a hose assembly will be used.

armor: a protective cover slid over and affixed to a hose assembly; used to prevent over bending or for the purpose of protecting hose from severe external environmental conditions such as hot materials, abrasion, or traffic.

assembly: a general term referring to any hose coupled with end fittings of any style attached to one or both ends.

ASTM: American Society for Testing and Materials.

attachment: the method of securing an end fitting to a hose (e.g., banding, crimping, swaging, or screw-together 2 piece or 3 piece-style field attachable fittings).

axial movement: compression or elongation along the longitudinal axis.

B

backing: a soft rubber layer between a hose tube and/or cover and wire to provide adhesion.

barb: the portion of a fitting that is inserted into the hose, usually comprised of two or more radial serrations or ridges designed to form a redundant seal between the hose and fitting.

barbed fitting: a two-piece hose fitting comprised of a barbed insert (nipple), normally with peripheral ridges or backward-slanted barbs, for inserting into a hose.

Barb-Tite: a line of low pressure push-on hose end fittings that is a trademark of Eaton Corporation.

bend radius: the radius of a bent section of hose measured to the innermost surface of the curved portion.

bend radius, minimum: the smallest radius at which a hose can be used.

blister: a raised area on the surface or a separation between layers usually creating a void or air-filled space in a vulcanized article.

blow out force: the force generated from the internal pressure attempting to push the fitting from the hose.

bore: the internal diameter of a tube, hose, or pipe.

braid: the woven portion of a hose used as reinforcement to increase pressure rating and add hoop strength. Various materials such as textile or metal wire are used. A hose may have one or more braids, outside or between layers of hose material.

braid wear: motion between the braided layers, which normally causes wear.

braided ply: a layer of braided reinforcement.

braid-over-braid: multiple plies of braid having no separating layers.

brand: a mark or symbol identifying or describing a product and/or manufacturer, that is embossed, inlaid or printed on the hose cover.

brass: a family of copper/zinc alloys.

brazing: a process of joining metals using a non-ferrous filler metal having a melting point that is lower than the "parent metals" to be joined, typically over +800°F (+427°C).

bronze: an alloy of copper, tin and zinc.

Bruiser: an abrasion resistant covered hydraulic hose that is a registered trademark of Eaton Corporation.

BSPP/BSPT: British Standard Pipe Parallel / British Standard Pipe Tapered. See fitting/coupling — pipe thread fittings.

C

CGA: Canadian Gas Association

carcass: the outer component usually intended to protect the reinforcement.

chalking: the formation of a powdery surface condition due to disintegration of surface binder or elastomer by weathering or other destructive environments.

checking: the short, shallow cracks on the surface of a rubber product resulting from damaging action of environmental conditions.

chemical compatibility: the relative degree to which a material may contact another without corrosion, degradation or adverse change of properties.

chemical resistance: the ability of a particular polymer, rubber compound, or metal to exhibit minimal physical and/or chemical property changes when in contact with one or more chemicals for a specified length of time, at specified concentrations, pressure, and temperature.

cold flexibility: relative ease of bending while being exposed to specified low temperature.

collet: a tool or die-set used to crimp a hose end fitting onto a hose. A crimping die-set is typically eight "fingers" designed for infinite diameter settings within a range or preset to a specific diameter for a given hose type and size.

Coll-O-Crimp: a line of hydraulic and pneumatic hose, hose fittings, and assembly equipment that is a registered trademark of Eaton Corporation.

combustible liquid: a liquid having a flash point at or above +100°F (+37.8°C).

compound: the mixture of rubber or plastic and other materials, which are combined to give the desired properties when used in the manufacture of a product.

compression fitting: see fitting/coupling – compression fitting.

conductive: the ability to transfer electrical potential.

configuration: the combination of fittings on a particular assembly.

convoluted: description of hose or innercore having annular or helical ridges formed to enhance flexibility.

core: the innermost continuous all-rubber or plastic element of a hose.

corrosion: the process of material degradation by chemical or electrochemical means.

corrosion resistance: ability of metal components to resist oxidation.

corrugated hose: hose with a carcass fluted, radially or helically, to enhance its flexibility or reduce its weight.

coupling: a frequently used alternative term for hose fitting.

cover: the outer component usually intended to protect the reinforcement.

CPE: chlorinated polyethylene, a rubber elastomer.

cracking: a sharp break or fissure in the surface, generally caused by strain and environmental conditions.

crimp diameter: the distance across opposite flats after crimping.

crimp/crimping: a hose end fitting attachment method utilizing a number of dies mounted in a radial configuration. The dies close perpendicular to the hose and fitting axis, compressing the socket around the hose.

cure: the act of vulcanization. See vulcanization.

cut off factor: the hose length to be subtracted from the overall assembly length that allows for the hose fitting extension beyond the end of the hose.

D

date code: any combination of numbers, letters, symbols or other methods used by a manufacturer to identify the time of manufacture of a product.

deburr: to remove ragged edges from the inside diameter of a hose or tube end.

design factor: a ratio used to establish the working pressure of the hose, based on the burst strength of the hose.

displacement: the amount of motion applied to a hose defined as inches for parallel offset and degrees for angular misalignment.

DNV: Det Norske (Norwegian) Veritas.

DOT: U.S. Department of Transportation.

DIN: Deutsche Industrial Norme (German).

durometer: an instrument for measuring the hardness of rubber and plastic compounds.

E

eccentricity: the condition resulting from the inside and outside diameters not having a common center.

effusion: the escape, usually of gases, through a material. See permeation.

elastic limit: the limiting extent to which a body may be deformed and yet return to its original shape after removal of the deforming force.

elastomer: any one of a group of polymeric materials, usually designated thermoset, such as natural rubber, or thermoplastic, which will soften with application of heat.

elongation: the increase in length expressed numerically as a percentage of the initial length.

EN (CEN): Committee for European Normalization

Ermeto: a steel tube fitting product trademarked by Eaton Corporation.

endurance test: a service or laboratory test, conducted to product failure, usually under normal use conditions.

EPDM: Ethylene Propylene Diene Monomer; an elastomer.

extrude/extruded/extrusion: forced through the shaping die of an extruder; extrusion may have a solid or hollow cross section.

F

fabric impression: impression formed on the rubber surface during vulcanization by contact with fabric wrap.

fabricator: the producer of hose assemblies.

fatigue: the weakening or deterioration of a material occurring when a repetitious or continuous application of stress causes strain, which could lead to failure.

FDA: United States Food and Drug Administration.

firesleeve: slip-on or integrally extruded sleeve used to retard the effects of fire in certain applications; most often made with silicone and/or fiberglass fiber.

fitting/coupling: a device attached to the end of the hose to facilitate connection. The following is only a partial list of types of fittings available.

- **banjo fitting:** a through bolted designed featuring a hollow circle or “donut” attached to one end of the fitting so that the inner diameter is along the hose axis.

- **compression fitting:** a fitting style that seals on a mating tube by compressing an internal ferrule against the tube O.D.

- **field attachable fitting:** a fitting designed to be attached to hose without crimping or swaging. This fitting is not always a reusable type fitting.

- **inverted flare fitting:** a fitting consisting of a male or female nut, trapped on a tube by flaring the end of the tube material to 45°.

- **JIC fittings:** Joint Industrial Council (no longer in existence). An engineering group that established an industry standard fitting design incorporating a 37° mating surface, male and female styles. These standards are now governed by SAE.

- **O-ring fittings:** a fitting that seals by means of an elastomeric ring of a specified material.

pipe thread fittings:

- **NPT:** National Pipe Taper. Pipe thread per ANSI B1.20.1

- **NPTF:** National Pipe Tapered for Fuels. (Dry-seal per ANSI B1.20.3)

- **NPSH:** National Pipe Straight Hose per ANSI B1.20.7

- **NPSM:** National Pipe Straight Mechanical. Straight thread per ANSI B1.20.1

- **NPSL:** National Pipe Straight Loosefit per ANSI B1.20.1

- **BSPP, BSPT:** British Standard Pipe Parallel, British Standard Pipe Taper.

- **quick connect fitting:** a fitting designed to quickly connect and disconnect. These fittings come in many styles and types.

- **split flange fitting:** a fitting consisting of a flange retainer and a flange of two halves. This design allows the flanges to be installed after the retainer has been attached to the hose, making the flange reusable. SAE code 61 and 62.

- **tube fitting:** a hose fitting of which the mating end conforms to a tube diameter.

flammable gases/liquid/media: a flammable gas, including liquefied gas, is one having a closed cup flash point below +100°F (+37.8°C) and a vapor pressure greater than 25 psi (174.2 KPa).

flex cracking: a surface cracking induced by repeated bending and straightening.

flow rate: a volume of media being conveyed in a given time period.

fluid: a gas or liquid medium.

fluorocarbon: an organic compound containing fluorine directly bonded to carbon. The ability of the carbon atom to form a large variety of structural chains gives rise to many fluorocarbons and fluorocarbon derivatives.

G

gpm: gallons per minute.

H

heat resistance: the property or ability to resist the deteriorating effects of elevated temperatures.

helical wire: normally a round helical wire embedded in the hose reinforcement layer to increase strength or to resist collapse.

helix: a shape formed by spiraling a wire or other reinforcement around the cylindrical body of a hose; typically used in suction hose.

hose: a flexible conduit consisting of a tube, reinforcement, and usually an outer cover.

hydrostatic testing: the use of liquid pressure to test a hose or hose assembly for leakage, twisting, and/or hose change-in-length.

Hytrel: registered trademark of E.I. du Pont de Nemours and Company.

I

I.D.: inside diameter.

identification yarn: a yarn of single or multiple colors, usually embedded in the hose wall, used to identify the manufacturer.

impression: a design formed during vulcanization in the surface of a hose by a method of transfer, such as fabric impression or molded impression.

impulse: an application of force in a manner to produce sudden strain or motion, such as hydraulic pressure applied in a hose.

innertube: the innermost layer of a hose; the hose material in contact with the medium.

insert: optional term for nipple. See nipple.

interlocking clamp: a clamp which engages the fitting in a manner which prevents the clamp from sliding off the fitting, typically a bolt or U-bolt style with interlocking fingers which engage an interlock ring on the fitting.

interlocking ferrule: a ferrule, which physically attaches to the fitting preventing the ferrule from sliding off the fitting.

ISO: International Standardization Organization.

J

jacket: the outer component usually intended to protect the reinforcement.

JIC: see fitting/coupling—JIC fittings.

K

kinking: a temporary or permanent distortion of the hose induced by bending beyond the minimum bend radius.

L

layline: the line of printed information that runs parallel on the side of a manufactured hose giving details such as part number, psi rating, hose size, and manufacturing data.

layer: a single thickness of rubber, fabric or wire between adjacent parts.

loop installation: the assembly is installed in a loop or “U” shape, and is most often used when frequent and/or large amounts of motion are involved.

LPG, LP Gas: liquefied petroleum gas.

M

MAWP: see pressure, maximum allowable working.

mandrel built: a hose fabricated and/or vulcanized on a mandrel.

manufacturer’s identification: a code symbol used on or in some hose to indicate the manufacturer.

media, medium: the substance(s) being conveyed through a system.

MMT: Merchant Marine Technical

MSHA: U.S. Mine Safety and Health Administration

N

NAHAD: National Association of Hose & Accessories Distributors.

Neoprene: a registered trademark of DuPont.

nipple: the internal member or portion of a hose fitting.

nitrile rubber (NB/Buna-N): a family of acrylonitrile elastomers used for hose.

nominal: a size indicator for reference only.

nomograph: a chart used to compare hose size to flow rate to recommended velocity.

non-conductive: the inability to transfer an electrical charge.

NPT/NPTF: national pipe threads. See fitting/coupling — pipe thread fittings.

nylon: a family of polyamide materials.

O

OAL: see overall length

O.D.: outside diameter.

OE/OEM: original equipment manufacturer.

oil resistance: the ability of the materials to withstand exposure to oil.

oil swell: the change in volume of a rubber article resulting from contact with oil.

operating conditions: the pressure, temperature, motion, and environment to which a hose assembly is subjected.

o-ring fitting: see fitting/coupling—O-ring.

ORS: a product name for a hose end configuration using a flat faced o-ring sealing method.

overall length (OAL): the total length of a hose assembly, which consists of the free hose length plus the length of the fitting(s).

oxidation: the reaction of oxygen on a material, usually evidenced by a change in the appearance or feel of the surface or by a change in physical properties.

ozone cracking: the surface cracks, checks, or crazing caused by exposure to an atmosphere containing ozone.

ozone resistance: the ability to withstand the deteriorating effects of ozone (generally cracking).

P

permanent fitting: the type of fitting which, once installed, may not be removed for re-use.

permeation: the process of migration of a substance into and through another, usually the movement of a gas into and through a hose material; the rate of permeation is specific to the substance, temperature, pressure, and the material being permeated.

pin pricked: perforations through the cover of a hose to vent permeating gases.

pitch: 1) the distance from one point on a helix to the corresponding point on the next turn of the helix, measured parallel to the axis; **2)** the distance between the two peaks of adjacent corrugation or convolution.

plating: a material, usually metal, applied to another metal by electroplating, for the purpose of reducing corrosion; typically a more noble metal such as zinc is applied to steel.

ply: an individual layer in hose construction.

polymer: a macromolecular material formed by the chemical combination of monomers, having either the same or different chemical compositions.

pressure: force ÷ unit area. For purposes of this document, refers to PSIG (pounds per square inch gauge).

pressure drop: the measure of pressure reduction or loss over a specific length of hose.

pressure, burst: the pressure at which rupture occurs.

pressure, maximum allowable working: the maximum pressure at which a hose or hose assembly is designed to be used. Abbreviated as MAWP.

pressure, working: the maximum pressure to which a hose will be subjected, including the momentary surges in pressure, which can occur during service. Abbreviated as WP.

psi: pounds per square inch.

PVC: polyvinyl chloride. A low cost thermoplastic material typically used in the manufacture of industrial hoses. The operating temperature range is -500°F to +1750°F (-295.5°C to +954.4°C).

R

reinforcement: the strengthening layer(s) of a hose. See ply.

reusable fitting/coupling: see fitting/coupling—field attachable fittings.

RhinoHide: an abrasion resistant covered hydraulic hose that is a registered trademark of Eaton Corporation.

RMA: The Rubber Manufacturers Association, Inc.

S

SAE: Society of Automotive Engineers.

shank: that portion of a fitting, which is inserted into the bore of a hose.

skive: the removal of a short length of cover and/or tube to permit the attachment of a fitting directly over the hose reinforcement.

smooth bore: the innermost layer of hose that is without convolution.

socket: the portion of a fitting that is compressed by crimping to seal the hose onto the nipple and create a permanent attachment. (With field attachable fittings, the lock and seal are accomplished mechanically by the socket and nipple without crimping).

Socketless™: a line of low pressure push-on hose fittings that is a trademark of Eaton Corporation.

specification: a document setting forth pertinent details of a product.

spiral: a method of applying reinforcement in which there is not interlacing between individual strands of the reinforcement.

spring guard: a helically wound component applied internally or externally to a hose assembly, used for strain relief, abrasion resistance, collapse resistance.

standard: a document, or an object for physical comparison, for defining product characteristics, products, or processes, prepared by a consensus of a properly constituted group of those substantially affected and having the qualifications to prepare the standard for use.

static wire: wire incorporated in a hose to conduct static electricity.

stem: see nipple.

surge (spike): a rapid and transient rise in pressure. See impulse.

swelling: an increase in volume or linear dimension of a specimen immersed in liquid or exposed to a vapor.

T

tube: the innermost continuous all-rubber or plastic element of a hose.

tube fitting: see fitting/coupling—tube.

tubing: a non-reinforced, homogeneous conduit, generally of circular cross-section.

U

UL: Underwriters Laboratories

USCG: U.S. Coast Guard

V

vacuum resistance: the measure of a hoses ability to resist negative gauge pressure.

vibration: amplitude motion occurring at a given frequency.

viscosity: the resistance of a material to flow.

vulcanization: a process during which a rubber compound, through a change in its chemical structure, improves or extends elastic properties over a greater range of temperature.

W

weathering: the surface deterioration of a hose cover during outdoor exposure, as shown by checking, cracking, crazing and chalking.

wire reinforced: a hose containing wires to give added strength, increased dimensional stability and crush resistance. See reinforcement.

working temperature: the temperature range of the application; may include the temperature of the fluid conveyed or the environmental conditions the assembly is exposed to in use.

WP: working pressure.

Part number index

M

Part number	page	Part number	page	Part number	page	Part number	page
00904B-102	I-8	04Z-506	H-36	05706B-102	I-9	06905E-665	H-12
00904B-104	I-8	04Z-58C	H-52	05706B-104	I-9	06905E-685	H-11
00904B-604	I-8	04Z-58D	H-51	05706B-106	I-9	06905E-B05	H-10
03E-102	H-2	04Z-58E	H-53	05706B-1412	I-9	06905E-E05	H-12
03E-104	H-2	04Z-603	H-33	05706B-1413	I-9	06905E-E45	H-11
03E-354	H-4	04Z-604	H-33	05706B-1414	I-10	06906D-104	I-18
03E-604	H-4	04Z-605	H-33	05706B-1415	I-10	06906D-406	I-19
03ER-104	H-2	04Z-606	H-33	05706B-1416	I-10	06906D-606	I-19
03ER-604	H-4	04Z-60C	H-52	05706B-1417	I-10	06906E-18K	H-11
04E-04L	H-4	04Z-60D	H-51	05706B-1568	I-9	06906E-406	H-10
04E-102	H-2	04Z-60E	H-53	05706B-1569	I-9	06906E-466	H-12
04E-104	H-2	04Z-62C	H-52	05706B-1570	I-9	06906E-486	H-11
04E-106	H-2	04Z-644	H-35	05706B-305	I-9	06906E-506	H-9
04E-354	H-4	04Z-645	H-35	05706B-B65	I-10	06906E-606	H-10
04E-504	H-3	04Z-664	H-35	05706B-B66	I-10	06906E-608	H-10
04E-505	H-3	04Z-665	H-35	05706B-C02	I-10	06906E-666	H-12
04E-506	H-3	04Z-666	H-35	05706B-C04	I-10	06906E-686	H-11
04E-604	H-4	04Z-684	H-34	05706B-C06	I-10	06906E-B06	H-10
04E-605	H-4	04Z-685	H-34	05708P-408	H-23	06906E-E04	H-12
04E-606	H-4	04Z-686	H-34	05710B-106	I-9	06906E-E05	H-12
04E-644	H-7	04Z-6PW	H-48	05710B-108	I-9	06906E-E06	H-12
04E-645	H-7	04Z-74P	H-49	05710B-C06	I-10	06906E-E46	H-11
04E-664	H-7	04Z-754	H-41	05710P-410	H-23	06908D-106	I-18
04E-665	H-7	04Z-755	H-41	05712B-108	I-9	06908D-108	I-18
04E-684	H-6	04Z-A24	H-38	05712P-412	H-23	06908D-608	I-19
04E-685	H-6	04Z-A26	H-38	05E-106	H-2	06908E-508	H-9
04E-74P	H-8	04Z-A64	H-39	05E-406	H-4	06908E-608	H-10
04E-A24	H-8	04Z-A66	H-39	05E-505	H-3	06908E-668	H-12
04E-A26	H-8	04Z-A68	H-39	05E-605	H-4	06908E-688	H-11
04E-A64	H-8	04Z-B03	H-42	05E-606	H-4	06908E-B08	H-10
04E-B03	H-3	04Z-B04	H-42	05E-646	H-7	06910D-108	I-18
04E-B04	H-3	04Z-B05	H-42	05E-665	H-7	06910D-610	I-19
04E-B05	H-3	04Z-B43	H-43	05E-666	H-7	06910E-22K	H-11
04E-B43	H-6	04Z-B44	H-43	05E-686	H-6	06910E-510	H-9
04E-B44	H-6	04Z-B45	H-43	05E-756	H-3	06910E-608	H-10
04E-B63	H-6	04Z-B63	H-43	05E-A26	H-8	06910E-610	H-10
04E-B64	H-6	04Z-B64	H-43	05E-A66	H-8	06910E-670	H-12
04E-J04	H-2	04Z-B65	H-43	05E-B05	H-3	06910E-690	H-11
04E-L64	H-6	04Z-BC06	H-54	05E-J04	H-2	06910E-E10	H-12
04E-L66	H-6	04Z-BC46	H-54	05E-J66	H-5	06912D-112	I-18
04E-S64	H-5	04Z-E64	H-40	05E-L66	H-6	06912D-412	I-19
04E-S66	H-5	04Z-J04	H-31	05ER-104	H-2	06912D-612	I-19
04Z-04L	H-50	04Z-J34	H-39	05ER-606	H-4	06912E-24K	H-11
04Z-04S	H-47	04Z-J36	H-39	05ER-J66	H-5	06912E-30K	H-11
04Z-054	H-32	04Z-J38	H-39	05E-S66	H-5	06912E-412	H-10
04Z-06A	H-52	04Z-L64	H-38	06904E-102	H-9	06912E-472	H-12
04Z-06C	H-51	04Z-L66	H-38	06904E-104	H-9	06912E-492	H-11
04Z-08A	H-52	04Z-M04	H-33	06905E-104	H-9	06912E-512	H-9
04Z-08C	H-51	04Z-P04	H-40	06906E-104	H-9	06912E-612	H-10
04Z-08D	H-51	04Z-P05	H-40	06906E-106	H-9	06912E-672	H-12
04Z-08E	H-52	04Z-P06	H-40	06908E-106	H-9	06912E-692	H-11
04Z-08F	H-53	04Z-P54	H-50	06908E-108	H-9	06916D-112	I-18
04Z-102	H-31	04Z-R04	H-41	06910E-108	H-9	06916D-116	I-18
04Z-104	H-31	04ZR-104	H-31	06910E-112	H-9	06916D-616	I-19
04Z-106	H-31	04ZR-604	H-33	06912E-112	H-9	06916D-X26	I-19
04Z-108	H-31	04Z-R66	H-41	06916E-112	H-9	06916E-33K	H-11
04Z-10A	H-52	04Z-S64	H-37	06916E-116	H-9	06916E-516	H-9
04Z-10C	H-51	04Z-S66	H-37	06920E-120	H-9	06916E-616	H-10
04Z-10D	H-51	04Z-S68	H-37	06924E-124	H-9	06916E-676	H-12
04Z-10E	H-52	04Z-T04	H-47	06932E-132	H-9	06916E-696	H-11
04Z-10F	H-53	05703B-102	I-9	06904D-102	I-18	06916E-X26	H-10
04Z-14K	H-50	05704B-102	I-9	06904D-104	I-18	06920D-120	I-18
04Z-154	H-49	05704B-104	I-9	06904D-604	I-19	06920D-620	I-19
04Z-202	H-32	05704B-B64	I-10	06904E-504	H-9	06920E-520	H-9
04Z-204	H-32	05704B-B65	I-10	06904E-604	H-10	06920E-620	H-10
04Z-254	H-32	05704B-C02	I-10	06904E-664	H-12	06920E-657	H-12
04Z-354	H-48	05705B-102	I-9	06904E-684	H-11	06920E-677	H-12
04Z-356	H-48	05705B-104	I-9	06904E-B04	H-10	06924D-124	I-18
04Z-38T	H-47	05705B-1560	I-9	06904E-E04	H-12	06924D-624	I-19
04Z-404	H-36	05705B-1561	I-9	06904E-E44	H-11	06924E-42K	H-11
04Z-40T	H-47	05705B-1598	I-9	06905D-104	I-18	06924E-524	H-9
04Z-44P	H-49	05705B-B65	I-10	06905D-605	I-19	06924E-624	H-10
04Z-504	H-36	05705B-C02	I-10	06905E-505	H-9	06924E-678	H-12
04Z-505	H-36	05705B-C04	I-10	06905E-605	H-10	06932D-132	I-18

Part number	page	Part number	page	Part number	page	Part number	page
06932D-632	I-19	06Z-46P	H-49	06Z-P58	H-50	08Z-512	H-36
06932E-632	H-10	06Z-486	H-36	06Z-R06	H-41	08Z-606	H-33
06940T-140	I-18	06Z-506	H-36	06Z-R08	H-41	08Z-608	H-33
06940T-640	I-19	06Z-508	H-36	06ZR-106	H-31	08Z-610	H-33
06E-104	H-2	06Z-510	H-36	06ZR-606	H-33	08Z-612	H-33
06E-106	H-2	06Z-604	H-33	06Z-R66	H-41	08Z-616	H-33
06E-108	H-2	06Z-605	H-33	06Z-R68	H-41	08Z-648	H-35
06E-06L	H-4	06Z-606	H-33	06Z-R70	H-41	08Z-64C	H-52
06E-356	H-4	06Z-608	H-33	06Z-S64	H-37	08Z-650	H-35
06E-358	H-4	06Z-60C	H-52	06Z-S66	H-37	08Z-65D	H-51
06E-406	H-4	06Z-60D	H-51	06Z-S68	H-37	08Z-666	H-35
06E-466	H-7	06Z-60E	H-53	06Z-T06	H-47	08Z-668	H-35
06E-506	H-3	06Z-610	H-33	08E-08L	H-4	08Z-66C	H-52
06E-508	H-3	06Z-612	H-33	08E-106	H-2	08Z-66E	H-53
06E-606	H-4	06Z-62C	H-52	08E-108	H-2	08Z-670	H-35
06E-608	H-4	06Z-62D	H-51	08E-358	H-4	08Z-688	H-34
06E-646	H-7	06Z-62E	H-53	08E-360	H-4	08Z-690	H-34
06E-648	H-7	06Z-644	H-35	08E-508	H-3	08Z-758	H-41
06E-666	H-7	06Z-646	H-35	08E-510	H-3	08Z-760	H-41
06E-668	H-7	06Z-648	H-35	08E-608	H-4	08Z-78P	H-49
06E-686	H-6	06Z-64C	H-52	08E-610	H-4	08Z-80P	H-49
06E-688	H-6	06Z-64E	H-53	08E-648	H-7	08Z-A26	H-38
06E-755	H-3	06Z-664	H-35	08E-650	H-7	08Z-A28	H-38
06E-756	H-3	06Z-666	H-35	08E-668	H-7	08Z-A30	H-38
06E-76P	H-8	06Z-668	H-35	08E-670	H-7	08Z-A32	H-38
06E-A26	H-8	06Z-684	H-34	08E-688	H-6	08Z-A68	H-39
06E-A28	H-8	06Z-686	H-34	08E-690	H-6	08Z-A70	H-39
06E-A66	H-8	06Z-688	H-34	08E-758	H-3	08Z-B08	H-42
06E-A68	H-8	06Z-6PVV	H-48	08E-78P	H-8	08Z-B10	H-42
06E-B05	H-3	06Z-754	H-41	08E-A28	H-8	08Z-B48	H-43
06E-B06	H-3	06Z-755	H-41	08E-A68	H-8	08Z-B68	H-43
06E-B45	H-6	06Z-756	H-41	08E-B08	H-3	08Z-BC08	H-54
06E-B46	H-6	06Z-76P	H-49	08E-B48	H-6	08Z-BC48	H-54
06E-B65	H-6	06Z-78P	H-49	08E-B50	H-6	08Z-BC68	H-54
06E-B66	H-6	06Z-956	H-42	08E-B68	H-6	08Z-BC88	H-54
06E-J06	H-2	06Z-976	H-42	08E-J08	H-2	08Z-E68	H-40
06E-L66	H-6	06Z-A24	H-38	08E-J68	H-5	08Z-E70	H-40
06E-S66	H-5	06Z-A26	H-38	08E-L68	H-6	08Z-E72	H-40
06E-S68	H-5	06Z-A28	H-38	08ER-108	H-2	08Z-G08	H-43
06Z-056	H-32	06Z-A66	H-39	08ER-608	H-4	08Z-G12	H-43
06Z-06L	H-50	06Z-A68	H-39	08ER-J68	H-5	08Z-G41	H-44
06Z-06PA	H-48	06Z-B04	H-42	08E-S68	H-5	08Z-G42	H-44
06Z-06S	H-47	06Z-B05	H-42	08E-S70	H-5	08Z-G71	H-45
06Z-08PA	H-48	06Z-B06	H-42	08E-T58	H-5	08Z-G72	H-45
06Z-08S	H-47	06Z-B07	H-42	08E-T60	H-5	08Z-J06	H-31
06Z-104	H-31	06Z-B45	H-43	08E-Y58	H-3	08Z-J08	H-31
06Z-106	H-31	06Z-B46	H-43	08E-Y60	H-3	08Z-J38	H-39
06Z-108	H-31	06Z-B47	H-43	08Z-058	H-32	08Z-J68	H-39
06Z-10A	H-52	06Z-B64	H-43	08Z-08L	H-50	08Z-J42	H-39
06Z-10C	H-51	06Z-B65	H-43	08Z-08PA	H-48	08Z-L66	H-38
06Z-10D	H-51	06Z-B66	H-43	08Z-08S	H-47	08Z-L68	H-38
06Z-10F	H-53	06Z-B67	H-43	08Z-104	H-31	08Z-L70	H-38
06Z-12A	H-52	06Z-BC06	H-54	08Z-106	H-31	08Z-L72	H-38
06Z-12C	H-51	06Z-BC08	H-54	08Z-108	H-31	08Z-M08	H-33
06Z-12D	H-51	06Z-BC46	H-54	08Z-112	H-31	08Z-P08	H-40
06Z-12E	H-52	06Z-BC66	H-54	08Z-12PA	H-48	08Z-P10	H-40
06Z-12F	H-53	06Z-BC68	H-54	08Z-158	H-49	08Z-P12	H-40
06Z-14E	H-52	06Z-BC86	H-54	08Z-15A	H-52	08Z-P56	H-50
06Z-14F	H-53	06Z-E66	H-40	08Z-15C	H-51	08Z-P58	H-50
06Z-156	H-49	06Z-E68	H-40	08Z-15D	H-51	08Z-R08	H-41
06Z-18K	H-50	06Z-J04	H-31	08Z-16E	H-52	08Z-R10	H-41
06Z-204	H-32	06Z-J06	H-31	08Z-16F	H-53	08ZR-108	H-31
06Z-206	H-32	06Z-J08	H-31	08Z-208	H-32	08Z-R12	H-41
06Z-256	H-32	06Z-J36	H-39	08Z-22K	H-50	08ZR-608	H-33
06Z-306	H-37	06Z-J38	H-39	08Z-258	H-32	08Z-R68	H-41
06Z-356	H-48	06Z-L64	H-38	08Z-358	H-48	08Z-R70	H-41
06Z-358	H-48	06Z-L66	H-38	08Z-360	H-48	08Z-R72	H-41
06Z-404	H-36	06Z-L68	H-38	08Z-408	H-36	08Z-S66	H-37
06Z-406	H-36	06Z-M04	H-33	08Z-410	H-36	08Z-S68	H-37
06Z-408	H-36	06Z-M06	H-33	08Z-45T	H-47	08Z-S70	H-37
06Z-40T	H-47	06Z-P06	H-40	08Z-46T	H-47	08Z-S72	H-37
06Z-42T	H-47	06Z-P08	H-40	08Z-48P	H-49	08Z-T08	H-47
06Z-446	H-37	06Z-P10	H-40	08Z-508	H-36	10004B-102	I-11
06Z-44T	H-47	06Z-P56	H-50	08Z-510	H-36	10004B-104	I-11

Index

Part number index

M

Part number	page	Part number	page	Part number	page	Part number	page
10004B-254	I-12	10506B-104	I-14	10Z-S72	H-37	12E-692	H-6
10004B-304	I-11	10506B-106	I-14	10Z-T10	H-47	12E-82P	H-8
10004B-305	I-11	10506B-108	I-14	1103	H-93	16E-116	H-2
10004B-604	I-12	10506B-202	I-14	11041	K-21	12E-J12	H-2
10004B-605	I-12	10506B-204	I-14	1104-1	H-93	12E-L72	H-6
10004B-A03	I-12	10506B-206	I-14	1104-2	H-93	12E-S72	H-5
10004B-A04	I-12	10508B-104	I-14	1105-1	H-93	12E-T60	H-5
10004B-A05	I-12	10508B-106	I-14	1105-1/8	H-93	12E-T62	H-5
10004B-B03	I-12	10508B-108	I-14	1106-1	H-93	12E-X92	H-5
10004B-B04	I-12	10508B-112	I-14	1106-2	H-93	12E-Y60	H-3
10004B-B05	I-12	10508B-204	I-14	1106-3	H-93	12E-Y62	H-3
10004B-X03	I-13	10508B-206	I-14	11076	K-20	12-F00	H-92
10004B-X04	I-13	10508B-208	I-14	11078	K-21	12Z-062	H-32
10004B-X05	I-13	10510B-106	I-14	11079	K-20	12Z-108	H-31
10004B-Y04	I-13	10510B-108	I-14	11080	K-21	12Z-112	H-31
10005B-102	I-11	10510B-112	I-14	1108-1	H-93	12Z-116	H-31
10005B-104	I-11	10512B-108	I-14	1108-2	H-93	12Z-12L	H-50
10005B-305	I-11	10512B-112	I-14	11089	K-21	12Z-12PA	H-48
10005B-605	I-12	10-S.37-316	H-97	11093	K-20	12Z-12S	H-47
10005B-A05	I-12	10Z-106	H-31	1110	H-93	12Z-162	H-49
10005B-B04	I-12	10Z-108	H-31	1112	H-93	12Z-20F	H-53
10005B-B05	I-12	10Z-112	H-31	1116	H-93	12Z-212	H-32
10005B-B06	I-12	10Z-12L	H-50	1116Z	H-93	12Z-22A	H-52
10005B-C02	I-13	10Z-18A	H-52	11205	K-20	12Z-22C	H-51
10005B-C04	I-13	10Z-18C	H-51	11208	K-21	12Z-22D	H-51
10005B-X05	I-13	10Z-18D	H-51	1120Z	H-93	12Z-25E	H-52
10005B-Y05	I-13	10Z-20E	H-52	11212	K-21	12Z-25F	H-53
10006B-102	I-11	10Z-20F	H-53	11215	K-20	12Z-262	H-32
10006B-104	I-11	10Z-24K	H-50	11216	K-20	12Z-30K	H-50
10006B-106	I-11	10Z-360	H-48	11217	K-20	12Z-312	H-37
10006B-256	I-12	10Z-48T	H-47	11219	K-21	12Z-362	H-48
10006B-306	I-11	10Z-508	H-36	11223	K-20	12Z-412	H-36
10006B-406	I-13	10Z-50P	H-49	11224	K-21	12Z-510	H-36
10006B-605	I-12	10Z-50T	H-47	11312	K-18	12Z-512	H-36
10006B-606	I-12	10Z-510	H-36	11318	K-18	12Z-514	H-36
10006B-A05	I-12	10Z-512	H-36	11358	K-18	12Z-516	H-36
10006B-A06	I-12	10Z-608	H-33	11461	K-20	12Z-52P	H-49
10006B-B05	I-12	10Z-610	H-33	11462	K-20	12Z-52T	H-47
10006B-B06	I-12	10Z-612	H-33	11463	K-20	12Z-55T	H-47
10006B-C02	I-13	10Z-650	H-35	11464	K-20	12Z-608	H-33
10006B-C04	I-13	10Z-670	H-35	11465	K-20	12Z-610	H-33
10006B-X06	I-13	10Z-672	H-35	11466	K-20	12Z-612	H-33
10006B-Y06	I-13	10Z-68D	H-51	11474	K-20	12Z-614	H-33
10008B-106	I-11	10Z-690	H-34	11477	K-20	12Z-616	H-33
10008B-108	I-11	10Z-692	H-34	11478	K-20	12Z-652	H-35
10008B-258	I-12	10Z-70C	H-52	11486	K-21	12Z-670	H-35
10008B-608	I-12	10Z-70E	H-53	120-00429	L-22	12Z-672	H-35
10008B-A08	I-12	10Z-80P	H-49	12-112	H-91	12Z-676	H-35
10008B-B08	I-12	10Z-A30	H-38	12-612	H-92	12Z-692	H-34
10008B-Y08	I-13	10Z-A32	H-38	1290-10S	J-127	12Z-696	H-34
10010B-108	I-11	10Z-A70	H-39	1290-12S	J-127	12Z-70C	H-52
10010B-610	I-12	10Z-BC10	H-54	1290-14S	J-127	12Z-72D	H-51
10010B-Y10	I-13	10Z-BC50	H-54	1290-16S	J-127	12Z-75C	H-52
10012B-112	I-11	10Z-BC70	H-54	1290-20S	J-127	12Z-75E	H-53
10012B-412	I-13	10Z-E70	H-40	1290-24S	J-127	12Z-762	H-41
10012B-610	I-12	10Z-E72	H-40	1290-2S	J-127	12Z-82P	H-49
10012B-612	I-12	10Z-G09	H-46	1290-32S	J-127	12Z-A30	H-38
10012B-Y12	I-13	10Z-G12	H-43	1290-3S	J-127	12Z-A32	H-38
10016B-116	I-11	10Z-G42	H-44	1290-4S	J-127	12Z-A36	H-38
10502B-102	I-14	10Z-G69	H-46	1290-5S	J-127	12Z-A72	H-39
10502B-202	I-14	10Z-G72	H-45	1290-6S	J-127	12Z-A76	H-39
10503B-102	I-14	10Z-G99	H-46	1290-8S	J-127	12Z-BC12	H-54
10503B-104	I-14	10Z-J40	H-39	12CA12-12	F-5, K-16	12Z-BC52	H-54
10503B-202	I-14	10Z-L22	H-34	12CAB12-12	F-5, K-16	12Z-BC72	H-54
10504B-102	I-14	10Z-L70	H-38	12CAR12-12	F-5, K-16	12Z-BC92	H-54
10504B-104	I-14	10Z-L72	H-38	12E-A32	H-8	12Z-E72	H-40
10504B-106	I-14	10Z-P08	H-40	12E-112	H-2	12Z-E76	H-40
10504B-202	I-14	10Z-P10	H-40	12E-12L	H-4	12Z-G12	H-43
10504B-204	I-14	10Z-P12	H-40	12E-362	H-4	12Z-G16	H-43
10505B-102	I-14	10Z-P60	H-50	12E-412	H-4	12Z-G20	H-43
10505B-104	I-14	10Z-R08	H-41	12E-512	H-3	12Z-G42	H-44
10505B-202	I-14	10ZR-610	H-33	12E-612	H-4	12Z-G46	H-44
10505B-204	I-14	10Z-S68	H-37	12E-652	H-7	12Z-G72	H-45
10506B-102	I-14	10Z-S70	H-37	12E-672	H-7	12Z-G76	H-45

Part number	page	Part number	page	Part number	page	Part number	page
12Z-G80	H-45	15.164-10-8	J-132	16Z-G20	H-43	1RA16FR16	I-4
12Z-J12	H-31	15.164-14-10	J-132	16Z-G46	H-44	1RA16FRA16	I-4
12Z-J40	H-39	15.164-16-12	J-132	16Z-G50	H-44	1RA16FRB16	I-4
12Z-J42	H-39	15.164-20-16	J-132	16Z-G76	H-45	1RA16FRC16	I-4
12Z-L70	H-38	15.164-30-24	J-132	16Z-G80	H-45	1RA16MJ16	I-2
12Z-L72	H-38	15.164-6-6	J-132	16Z-G84	H-45	1RA16MP16	I-2
12Z-L76	H-38	15.165-20-16	J-133	16Z-H03	H-44	1RA2MP4	I-2
12Z-M12	H-33	15.165-25-20	J-133	16Z-H04	H-44	1RA4	I-2 – I-4
12Z-P10	H-40	15.165-32-24	J-133	16Z-H53	H-45	1RA4FJ4	I-2
12Z-P12	H-40	1538	K-28, I-10	16Z-J16	H-31	1RA4FJA4	I-3
12Z-P16	H-40	1539	K-28, I-10	16Z-J46	H-39	1RA4FJB4	I-3
12Z-P62	H-50	1540	K-28, I-10	16Z-J50	H-39	1RA4FJC4	I-3
12Z-R10	H-41	15CA12-12	F-5, K-16	16Z-L72	H-38	1RA4FR4	I-4
12ZR-112	H-31	15CA48-12	F-5, K-16	16Z-L76	H-38	1RA4FRA4	I-4
12ZR-612	H-33	15CAB12-12	F-5, K-16	16Z-L80	H-38	1RA4FRB4	I-4
12Z-R72	H-41	15CAB48-12	F-5, K-16	16Z-P16	H-40	1RA4FRC4	I-4
12Z-S70	H-37	15CAR12-12	F-5, K-16	16Z-P66	H-50	1RA4MJ4	I-2
12Z-S72	H-37	15CAR48-12	F-5, K-16	16ZR-116	H-31	1RA4MP4	I-2
12Z-S76	H-37	16-116	H-91	16ZR-616	H-33	1RA4MP6	I-2
12Z-T12	H-47	16-616	H-92	16Z-S72	H-37	1RA6	I-2 – I-4
1303	H-93	16E-16L	H-4	16Z-S76	H-37	1RA6FJ6	I-2
1303-4	H-93	16E-366	H-4	16Z-S80	H-37	1RA6FJA6	I-3
1304	H-93	16E-516	H-3	16Z-T16	H-47	1RA6FJB6	I-3
1305	H-93	16E-616	H-4	185263-12S	I-3, I-6	1RA6FJC6	I-3
1306	H-93	16E-656	H-7	185263-16S	I-3, I-6	1RA6FR6	I-4
1308	H-93	16E-676	H-7	185263-4S	I-3, I-6	1RA6FRA6	I-4
1310	H-93	16E-696	H-6	185263-6S	I-3, I-6	1RA6FRB6	I-4
1312	H-93	16E-A36	H-8	185263-8S	I-3, I-6	1RA6FRC6	I-4
1316	H-93	16E-L76	H-6	185264-12S	I-3, I-6	1RA6MJ6	I-2
1316Z	H-93	16E-S76	H-5	185264-16S	I-3, I-6	1RA6MP6	I-2
1320Z	H-93	16-F00	H-92	185264-4S	I-3, I-6	1RA6MP8	I-2
1390x6	H-28, I-16	16-S.87-316	H-97	185264-6S	I-3, I-6	1RA8	I-2 – I-4
1390x6x6	H-28, I-16	16-S16	H-92	185264-8S	I-3, I-6	1RA8FJ8	I-2
1390x6x8	H-28, I-16	16Z-066	H-32	185287-12S	I-3, I-6	1RA8FJA8	I-3
1390x8	H-28, I-16	16Z-112	H-31	185287-16S	I-3, I-6	1RA8FJB8	I-3
1390x8x8	H-28, I-16	16Z-116	H-31	185287-4S	I-3, I-6	1RA8FJC8	I-3
1391x6	I-17	16Z-120	H-31	185287-6S	I-3, I-6	1RA8FR8	I-4
1391x6x6	I-17	16Z-166	H-49	185287-8S	I-3, I-6	1RA8FRA8	I-4
1391x6x8	I-17	16Z-16L	H-50	1909	K-18	1RA8FRB8	I-4
1391x8	I-17	16Z-16S	H-47	1910	K-18	1RA8FRC8	I-4
1391x8x8	I-17	16Z-266	H-32	1F20340-0808-S	I-57	1RA8MJ8	I-2
140-05485-01	L-23	16Z-28A	H-52	1F40104-06C	I-59, I-62	1RA8MP8	I-2
140-06601	L-23	16Z-28C	H-51	1F40104-08C	I-59, I-62	200001-10-10B	J-128
140-06675	L-22	16Z-28D	H-51	1F40104-10C	I-59, I-62	200001-12-12B	J-128
140-06745	L-22	16Z-30E	H-52	1F40104-12C	I-59, I-62	200001-4-4B	J-128
140-06748	L-22	16Z-30F	H-53	1F40104-16C	I-59, I-62	200001-4-5B	J-128
140-06761	L-28, L-29	16Z-33K	H-50	1F40104-size	I-61	200001-4-6B	J-128
140-06894	L-23	16Z-366	H-48	1F40105-06C	I-59, I-62	200001-5-4B	J-128
140-06906	L-23	16Z-514	H-36	1F40105-08C	I-59, I-62	200001-5-5B	J-128
15.063-10-8	J-131	16Z-516	H-36	1F40105-10C	I-59, I-62	200001-5-6B	J-128
15.063-12-8	J-131	16Z-520	H-36	1F40105-12C	I-59, I-62	200001-6-5B	J-128
15.063-15-10	J-131	16Z-56P	H-49	1F40105-16C	I-59, I-62	200001-6-6B	J-128
15.063-18-12	J-131	16Z-58T	H-47	1F40105-size	I-61	200001-7-6B	J-128
15.063-6-4	J-131	16Z-60T	H-47	1F40106-06	I-62	200001-7-8B	J-128
15.063-8-6	J-131	16Z-612	H-33	1F40106-08	I-62	200001-8-6B	J-128
15.117-10-8	J-131	16Z-614	H-33	1F40106-10	I-62	200001-8-8B	J-128
15.117-16-12	J-131	16Z-616	H-33	1F40106-12	I-62	2000-12-10B	J-89
15.117-25-20	J-131	16Z-620	H-33	1F40106-16	I-62	2000-12-12B	J-89
15.117-4-4	J-131	16Z-656	H-35	1RA12	I-2 – I-4	2000-12-8B	J-89
15.117-6-6	J-131	16Z-676	H-35	1RA12FJ12	I-2	2000-2-4B	J-89
15.117-8-6	J-131	16Z-677	H-35	1RA12FJA12	I-3	2000-2-5B	J-89
15.117-8-8	J-131	16Z-696	H-34	1RA12FJB12	I-3	2000-2-6B	J-89
15.147-10-8	J-131	16Z-766	H-41	1RA12FJC12	I-3	2000-4-4B	J-89
15.147-14-10	J-131	16Z-78D	H-51	1RA12FR12	I-4	2000-4-5B	J-89
15.147-16-12	J-131	16Z-80C	H-52	1RA12FRA12	I-4	2000-4-6B	J-89
15.147-20-16	J-131	16Z-80E	H-53	1RA12FRB12	I-4	2000-4-8B	J-89
15.147-6-6	J-131	16Z-86P	H-49	1RA12FRC12	I-4	2000-6-10B	J-89
15.163-10-8	J-132	16Z-A36	H-38	1RA12MJ12	I-2	2000-6-4B	J-89
15.163-13-10	J-132	16Z-A40	H-38	1RA12MP12	I-2	2000-6-5B	J-89
15.163-16-12	J-132	16Z-A76	H-39	1RA16	I-2 – I-4	2000-6-6B	J-89
15.163-4-4	J-132	16Z-BC16	H-54	1RA16FJ16	I-2	2000-6-8B	J-89
15.163-6-6	J-132	16Z-BC76	H-54	1RA16FJA16	I-3	2000-8-10B	J-89
15.163-8-6	J-132	16Z-E76	H-40	1RA16FJB16	I-3	2000-8-12B	J-89
15.163-8-8	J-132	16Z-G16	H-43	1RA16FJC16	I-3	2000-8-4B	J-89

Part number index

M

Part number	page	Part number	page	Part number	page	Part number	page
2000-8-6B	J-89	2018-8-10S	J-79	2021-6-8S	J-77	2024-12-6S	J-82
2000-8-8B	J-89	2018-8-12S	J-79	2021-8-10S	J-77	2024-12-8S	J-82
2001-12-10B	J-89	2018-8-8S	J-79	2021-8-12S	J-77	202413-12-12S	J-83
2001-12-12B	J-89	202003-6-6S	J-88	2021-8-4S	J-77	202413-12-16S	J-83
2001-2-4B	J-89	2020-12-12S	J-102	2021-8-6S	J-77	202413-16-16S	J-83
2001-2-5B	J-89	2020-16-16S	J-102	2021-8-8S	J-77	202413-20-20S	J-83
2001-2-6B	J-89	2020-4-4S	J-102	2022-12-10S	J-80	202413-2-4S	J-83
2001-4-4B	J-89	2020-6-6S	J-102	2022-12-12S	J-80	202413-4-4S	J-83
2001-4-5B	J-89	2020-8-8S	J-102	2022-12-16S	J-80	202413-4-5S	J-83
2001-6-10B	J-89	2021-12-10S	J-77	2022-12-8S	J-80	202413-4-6S	J-83
2001-6-4B	J-89	2021-12-12S	J-77	2022-16-12S	J-80	202413-6-6S	J-83
2001-6-5B	J-89	2021-12-14S	J-77	2022-16-16S	J-80	202413-6-8S	J-83
2001-6-8B	J-89	2021-12-16S	J-77	2022-20-16S	J-80	202413-8-10S	J-83
2001-8-10B	J-89	2021-12-6S	J-77	2022-20-20S	J-80	202413-8-12S	J-83
2001-8-12B	J-89	2021-12-8S	J-77	2022-2-2S	J-80	202413-8-8S	J-83
2001-8-6B	J-89	202113-12-12S	J-78	2022-2-3S	J-80	202414-2-4S	J-84
2001-8-8B	J-89	202113-16-16S	J-78	2022-24-24S	J-80	202414-4-4S	J-84
2002-12-12B	J-90	202113-20-20S	J-78	2022-2-4S	J-80	202414-4-6S	J-84
2002-2-4B	J-90	202113-24-24S	J-78	2022-2-5S	J-80	202414-8-10S	J-84
2002-4-4B	J-90	202113-2-4S	J-78	202232-1/2-12S	J-123	2024-16-12S	J-82
2002-4-6B	J-90	202113-2-5S	J-78	202232-1/4-8S	J-123	2024-16-16S	J-82
2002-6-10B	J-90	202113-32-32S	J-78	202232-1-20S	J-123	2024-16-20S	J-82
2002-6-4B	J-90	202113-4-4S	J-78	2022-32-32S	J-80	2024-20-16S	J-82
2002-6-6B	J-90	202113-4-5S	J-78	2022-4-3S	J-80	2024-20-20S	J-82
2002-6-8B	J-90	202113-4-6S	J-78	2022-4-4S	J-80	2024-20-24S	J-82
2002-8-10B	J-90	202113-6-6S	J-78	2022-4-5S	J-80	2024-2-3S	J-82
2002-8-12B	J-90	202113-6-8S	J-78	2022-4-6S	J-80	2024-24-20S	J-82
2002-8-8B	J-90	202113-8-10S	J-78	2022-4-8S	J-80	2024-24-24S	J-82
2003-12-10B	J-90	202113-8-12S	J-78	2022-6-10S	J-80	2024-24-32S	J-82
2003-12-12B	J-90	202113-8-8S	J-78	2022-6-6S	J-80	2024-2-4S	J-82
2003-12-8B	J-90	202114-12-12S	J-78	2022-6-8S	J-80	2024-2-5S	J-82
2003-2-4B	J-90	202114-12-16S	J-78	2022-8-10S	J-80	2024-2-6S	J-82
2003-2-5B	J-90	202114-16-16S	J-78	2022-8-12S	J-80	2024-32-32S	J-82
2003-2-6B	J-90	202114-2-4S	J-78	2022-8-6S	J-80	2024-4-4S	J-82
2003-4-4B	J-90	202114-4-4S	J-78	2022-8-8S	J-80	2024-4-5S	J-82
2003-4-5B	J-90	202114-4-5S	J-78	2023-12-10S	J-81	2024-4-6S	J-82
2003-4-6B	J-90	202114-4-6S	J-78	2023-12-12S	J-81	2024-4-8S	J-82
2003-4-8B	J-90	202114-6-8S	J-78	2023-12-16S	J-81	2024-6-10S	J-82
2003-6-10B	J-90	202114-8-10S	J-78	2023-12-8S	J-81	2024-6-12S	J-82
2003-6-4B	J-90	202114-8-6S	J-78	2023-16-12S	J-81	2024-6-4S	J-82
2003-6-5B	J-90	2021-16-12S	J-77	2023-16-16S	J-81	2024-6-5S	J-82
2003-6-6B	J-90	2021-16-16S	J-77	2023-16-20S	J-81	2024-6-6S	J-82
2003-6-8B	J-90	2021-16-20S	J-77	2023-2-3S	J-81	2024-6-8S	J-82
2003-8-10B	J-90	2021-16-24S	J-77	2023-24-24S	J-81	2024-8-10S	J-82
2003-8-12B	J-90	2021-20-12S	J-77	2023-2-4S	J-81	2024-8-12S	J-82
2003-8-6B	J-90	2021-20-16S	J-77	2023-2-5S	J-81	2024-8-16S	J-82
2003-8-8B	J-90	2021-20-20S	J-77	2023-2-6S	J-81	2024-8-4S	J-82
2004-12-16S	J-128	2021-20-24S	J-77	2023-32-32S	J-81	2024-8-6S	J-82
2004-16-16S	J-128	2021-2-2S	J-77	2023-4-4S	J-81	2024-8-8S	J-82
2007-2-4B	J-90	2021-2-3S	J-77	2023-4-5S	J-81	2025-12-12S	J-85
2007-4-4B	J-90	2021-24-12S	J-77	2023-4-6S	J-81	2025-16-16S	J-85
2007-4-6B	J-90	2021-24-16S	J-77	2023-4-8S	J-81	2025-20-20S	J-85
2007-6-10B	J-90	2021-24-20S	J-77	2023-6-10S	J-81	2025-24-24S	J-85
2007-6-6B	J-90	2021-24-24S	J-77	2023-6-4S	J-81	2025-2-4S	J-85
2007-6-8B	J-90	2021-24-32S	J-77	2023-6-6S	J-81	2025-2-5S	J-85
2007-8-10B	J-90	202124-3-3S	J-128	2023-6-8S	J-81	2025-2-6S	J-85
2007-8-6B	J-90	202124-3-4S	J-128	2023-8-10S	J-81	2025-4-4S	J-85
2007-8-8B	J-90	202124-4-4S	J-128	2023-8-12S	J-81	2025-4-5S	J-85
20-120	H-91	202124-5-5S	J-128	2023-8-6S	J-81	2025-4-6S	J-85
2015-12-12S	J-61	202124-6-6S	J-128	2023-8-8S	J-81	2025-4-8S	J-85
2015-16-16S	J-61	202124-8-8S	J-128	202411-12-12S	J-83	2025-6-4S	J-85
2015-24-24S	J-61	2021-2-4S	J-77	202411-12-16S	J-83	2025-6-6S	J-85
2015-8-8S	J-61	2021-2-5S	J-77	202411-16-16S	J-83	2025-6-8S	J-85
2018-12-12S	J-79	2021-2-6S	J-77	202411-20-20S	J-83	2025-8-10S	J-85
2018-12-16S	J-79	2021-2-8S	J-77	202411-2-4S	J-83	2025-8-12S	J-85
2018-16-16S	J-79	2021-32-32S	J-77	202411-4-4S	J-83	2025-8-8S	J-85
2018-20-20S	J-79	2021-4-4S	J-77	202411-4-6S	J-83	202702-10-10S	J-104
2018-2-4S	J-79	2021-4-5S	J-77	202411-6-6S	J-83	202702-10-12S	J-104
2018-4-4S	J-79	2021-4-6S	J-77	202411-6-8S	J-83	202702-10-16S	J-104
2018-4-5S	J-79	2021-4-8S	J-77	202411-8-10S	J-83	202702-10-4S	J-104
2018-4-6S	J-79	2021-6-10S	J-77	202411-8-8S	J-83	202702-10-6S	J-104
2018-6-10S	J-79	2021-6-4S	J-77	2024-12-10S	J-82	202702-10-8S	J-104
2018-6-6S	J-79	2021-6-5S	J-77	2024-12-12S	J-82	202702-12-10S	J-104
2018-6-8S	J-79	2021-6-6S	J-77	2024-12-16S	J-82	202702-12-12S	J-104

Part number	page	Part number	page	Part number	page	Part number	page
202702-12-16S	J-104	2028-20-20S	J-86	203102-4-4S	J-101	2042-1-10-10S	J-97
202702-12-8S	J-104	2028-2-4S	J-86	203102-5-5S	J-101	2042-1-12-12S	J-97
202702-14-12S	J-104	2028-4-4S	J-86	203102-6-6S	J-101	2042-1-4-4S	J-97
202702-14-14S	J-104	2028-4-5S	J-86	203102-8-8S	J-101	2042-1-5-5S	J-97
202702-16-10S	J-104	2028-4-6S	J-86	203103-12-12S	J-86	2042-1-6-6S	J-97
202702-16-12S	J-104	2028-6-6S	J-86	203103-16-16S	J-86	2042-1-8-8S	J-97
202702-16-16S	J-104	2028-6-8S	J-86	203103-2-4S	J-86	2043-1-10-10S	J-98
202702-16-20S	J-104	2028-8-10S	J-86	203103-4-6S	J-86	2043-1-12-12S	J-98
202702-16-8S	J-104	2028-8-8S	J-86	203103-6-6S	J-86	2043-1-16-16S	J-98
202702-20-12S	J-104	202901-12-12S	J-87	203103-6-8S	J-86	2043-1-4-4S	J-98
202702-20-16S	J-104	202901-16-16S	J-87	203103-8-10S	J-86	2043-1-5-5S	J-98
202702-20-20S	J-104	202901-4-6S	J-87	203104-16-16S	J-87	2043-1-6-6S	J-98
202702-24-24S	J-104	2029-12-12S	J-88	203104-4-6S	J-87	2043-1-8-8S	J-98
202702-2-2S	J-104	2029-16-16S	J-88	2031-12-12S	J-88	2044-12-12S	J-80
202702-24-16S	J-104	2029-2-4S	J-88	2031-16-16S	J-88	2044-4-6S	J-80
202702-24-20S	J-104	2029-4-6S	J-88	2031-2-4S	J-88	2044-6-8S	J-80
202702-24-24S	J-104	203002-1-10-10S	J-100	2031-32-32S	J-88	2044-8-10S	J-80
202702-24-32S	J-104	203002-1-12-12S	J-100	2031-4-4S	J-88	2045-12-12S	J-66
202702-32-32S	J-104	203002-1-16-16S	J-100	2031-4-6S	J-88	2045-12-16S	J-66
202702-3-3S	J-104	203002-1-4-4S	J-100	2031-6-8S	J-88	2045-12-8S	J-66
202702-4-4S	J-104	203002-1-6-6S	J-100	2031-8-10S	J-88	2045-16-12S	J-66
202702-4-5S	J-104	203002-1-8-8S	J-100	2031-8-8S	J-88	2045-16-16S	J-66
202702-4-6S	J-104	203003-10-10S	J-108	203301-12-12S	J-86	2045-16-20S	J-66
202702-5-4S	J-104	203003-12-12S	J-108	203301-16-16S	J-86	2045-20-16S	J-66
202702-5-5S	J-104	203003-16-16S	J-108	203301-2-4S	J-86	2045-20-20S	J-66
202702-5-6S	J-104	203003-20-20S	J-108	203301-4-6S	J-86	2045-20-24S	J-66
202702-6-4S	J-104	203003-4-4S	J-108	203301-6-8S	J-86	2045-2-2S	J-66
202702-6-5S	J-104	203003-6-6S	J-108	203301-8-10S	J-86	2045-24-20S	J-66
202702-6-6S	J-104	203003-8-8S	J-108	2033-10-10S	J-100	2045-24-24S	J-66
202702-6-8S	J-104	203005-10-10S	J-108	2033-12-12S	J-100	2045-2-4S	J-66
202702-8-10S	J-104	203005-12-12S	J-108	2033-16-16S	J-100	2045-32-32S	J-66
202702-8-12S	J-104	203005-16-16S	J-108	2033-20-20S	J-100	2045-4-2S	J-66
202702-8-4S	J-104	203005-20-20S	J-108	2033-24-24S	J-100	2045-4-4S	J-66
202702-8-6S	J-104	203005-4-4S	J-108	2033-4-4S	J-100	2045-4-6S	J-66
202702-8-8S	J-104	203005-5-5S	J-108	2033-5-5S	J-100	2045-4-8S	J-66
2027-10-10S	J-94	203005-6-6S	J-108	2033-6-6S	J-100	2045-6-4S	J-66
2027-10-8S	J-94	203005-8-8S	J-108	2033-8-8S	J-100	2045-6-6S	J-66
202712-10-10S	J-95	203006-12-12S	J-87	2039-10-10S	J-98	2045-6-8S	J-66
2027-12-10S	J-94	203006-16-16S	J-87	2039-12-12S	J-98	2045-8-12S	J-66
202712-12-12S	J-95	203006-20-20S	J-87	2039-16-16S	J-98	2045-8-6S	J-66
2027-12-12S	J-94	203006-4-6S	J-87	2039-20-20S	J-98	2045-8-8S	J-66
202712-16-16S	J-95	203006-6-8S	J-87	2039-24-24S	J-98	2046-12-12S	J-66
202712-20-20S	J-95	203006-8-10S	J-87	2039-4-4S	J-98	2046-12-16S	J-66
202712-4-4S	J-95	203007-12-12S	J-85	2039-5-5S	J-98	2046-16-16S	J-66
202712-6-6S	J-95	203007-16-16S	J-85	2039-6-6S	J-98	2046-20-20S	J-66
202712-8-8S	J-95	203007-2-4S	J-85	2039-8-8S	J-98	2046-2-2S	J-66
2027-12-8S	J-94	203007-4-6S	J-85	2040-12-16S	J-65	2046-24-24S	J-66
202713-10-10S	J-105	203007-6-8S	J-85	2040-16-20S	J-65	2046-2-4S	J-66
202713-12-12S	J-105	203008-12-12S	J-101	2040-20-24S	J-65	2046-32-32S	J-66
202713-16-16S	J-105	203008-16-16S	J-101	2040-24-32s	J-65	2046-4-4S	J-66
202713-4-4S	J-105	203008-20-20S	J-101	2040-2-4S	J-65	2046-4-6S	J-66
202713-6-6S	J-105	203008-6-6S	J-101	2040-2-8S	J-65	2046-6-4S	J-66
202713-6-8S	J-105	203008-8-8S	J-101	2040-4-12S	J-65	2046-6-6S	J-66
202713-8-8S	J-105	2030-12-12S	J-87	2040-4-6S	J-65	2046-6-8S	J-66
2027-14-14S	J-94	2030-16-16S	J-87	2040-4-8S	J-65	2046-8-6S	J-66
2027-16-12S	J-94	2030-2-4S	J-87	2040-6-8S	J-65	2046-8-8S	J-66
2027-16-16S	J-94	2030-2-5S	J-87	2040-8-12S	J-65	2047-12-12S	J-72
2027-20-20S	J-94	2030-4-4S	J-87	2040-8-16S	J-65	2047-12-16S	J-72
2027-2-2S	J-94	2030-4-6S	J-87	2041-1-10-10S	J-95	2047-12-8S	J-72
2027-24-24S	J-94	2030-6-6S	J-87	2041-1-12-12S	J-95	2047-16-12S	J-72
2027-32-32S	J-94	2030-6-8S	J-87	2041-1-16-16S	J-95	2047-16-16S	J-72
2027-3-3S	J-94	2030-8-10S	J-87	2041-1-20-20S	J-95	2047-20-20S	J-72
2027-4-4S	J-94	2030-8-8S	J-87	2041-12-12S	J-95	2047-2-2S	J-72
2027-5-4S	J-94	203101-10-10S	J-101	2041-1-3-3S	J-95	2047-24-24S	J-72
2027-5-5S	J-94	203101-12-12S	J-101	2041-1-4-4S	J-95	2047-2-4S	J-72
2027-6-4S	J-94	203101-16-16S	J-101	2041-1-5-5S	J-95	2047-32-32S	J-72
2027-6-5S	J-94	203101-20-20S	J-101	2041-1-6-6S	J-95	2047-4-2S	J-72
2027-6-6S	J-94	203101-4-4S	J-101	2041-1-8-8S	J-95	2047-4-4S	J-72
2027-8-4S	J-94	203101-6-6S	J-101	2041-20-20S	J-95	2047-4-6S	J-72
2027-8-6S	J-94	203101-8-8S	J-101	2041-3-3S	J-95	2047-4-8S	J-72
2027-8-8S	J-94	203102-10-10S	J-101	2041-4-4S	J-95	2047-6-12S	J-72
2028-12-10S	J-86	203102-12-12S	J-101	2041-5-5S	J-95	2047-6-4S	J-72
2028-12-12S	J-86	203102-16-16S	J-101	2041-6-6S	J-95	2047-6-6S	J-72
2028-16-16S	J-86	203102-20-20S	J-101	2041-8-8S	J-95	2047-6-8S	J-72

Index

Part number index

M

Part number	page	Part number	page	Part number	page	Part number	page
2047-8-12S	J-72	2061-8-8S	J-106	2066-8-8S	J-91	2081-12-8S	J-63
2047-8-6S	J-72	20-620	H-92	2067-12-12S	J-92	2081-16-12S	J-63
2047-8-8S	J-72	206209-10-10S	J-106	2067-12-16S	J-92	2081-16-4S	J-63
2048-12-12S	J-71	206209-12-12S	J-106	2067-12-8S	J-92	2081-16-6S	J-63
2048-12-8S	J-71	206209-16-16S	J-106	2067-16-16S	J-92	2081-16-8S	J-63
2048-16-16S	J-71	206209-6-6S	J-106	2067-20-20S	J-92	2081-20-12S	J-63
2048-20-20S	J-71	206209-8-10S	J-106	2067-4-4S	J-92	2081-20-16S	J-63
2048-2-2S	J-71	206209-8-8S	J-106	2067-6-4S	J-92	2081-20-8S	J-63
2048-24-24S	J-71	2062-10-10S	J-107	2067-6-6S	J-92	2081-24-12S	J-63
2048-4-4S	J-71	2062-10-12S	J-107	2067-6-8S	J-92	2081-24-16S	J-63
2048-4-6S	J-71	2062-10-6S	J-107	2067-8-10S	J-92	2081-24-20S	J-63
2048-4-8S	J-71	2062-10-8S	J-107	2067-8-6S	J-92	2081-32-16S	J-63
2048-6-4S	J-71	2062-12-10S	J-107	2067-8-8S	J-92	2081-32-20S	J-63
2048-6-6S	J-71	2062-12-12S	J-107	206801-12-12S	J-93	2081-32-24S	J-63
2048-6-8S	J-71	2062-12-16S	J-107	206801-16-16S	J-93	2081-4-2S	J-63
2048-8-12S	J-71	2062-12-20S	J-107	206801-20-20S	J-93	2081-6-2S	J-63
2048-8-6S	J-71	2062-12-8S	J-107	206801-4-6S	J-93	2081-6-4S	J-63
2048-8-8S	J-71	2062-14-16S	J-107	206801-6-8S	J-93	2081-8-2S	J-63
2049-12-12S	J-68	2062-16-10S	J-107	206801-8-10S	J-93	2081-8-4S	J-63
2049-12-16S	J-68	2062-16-12S	J-107	206801-8-8S	J-93	2081-8-6S	J-63
2049-12-8S	J-68	2062-16-16S	J-107	206804-12-12S	J-93	2082-12S	J-64
2049-16-12S	J-68	2062-16-20S	J-107	206804-16-16S	J-93	2082-16S	J-64
2049-16-16S	J-68	2062-16-8S	J-107	206804-6-8S	J-93	2082-20S	J-64
2049-16-20S	J-68	2062-20-16S	J-107	206804-8-10S	J-93	2082-24S	J-64
2049-20-20S	J-68	2062-20-20S	J-107	2068-12-10S	J-93	2082-2S	J-64
2049-2-2S	J-68	2062-20-24S	J-107	2068-12-12S	J-93	2082-32S	J-64
2049-24-24S	J-68	2062-24-20S	J-107	2068-12-16S	J-93	2082-4S	J-64
2049-4-2S	J-68	2062-24-24S	J-107	2068-12-8S	J-93	2082-6S	J-64
2049-4-4S	J-68	2062-4-4S	J-107	2068-16-16S	J-93	2082-8S	J-64
2049-4-6S	J-68	2062-4-5S	J-107	2068-20-16S	J-93	2083-1-1S	J-61
2049-4-8S	J-68	2062-4-6S	J-107	2068-20-20S	J-93	2083-12-12S	J-61
2049-6-4S	J-68	2062-5-4S	J-107	2068-4-4S	J-93	2083-12-6S	J-61
2049-6-6S	J-68	2062-5-5S	J-107	2068-4-6S	J-93	2083-12-8S	J-61
2049-6-8S	J-68	2062-5-6S	J-107	2068-6-10S	J-93	2083-16-12S	J-61
2049-8-12S	J-68	2062-6-4S	J-107	2068-6-4S	J-93	2083-16-16S	J-61
2049-8-6S	J-68	2062-6-5S	J-107	2068-6-6S	J-93	2083-20-16S	J-61
2049-8-8S	J-68	2062-6-6S	J-107	2068-6-8S	J-93	2083-20-20S	J-61
2050-12-12S	J-67	2062-6-8S	J-107	2068-8-10S	J-93	2083-2-1S	J-61
2050-12-16S	J-67	2062-8-10S	J-107	2068-8-12S	J-93	2083-2-2S	J-61
2050-16-16S	J-67	2062-8-12S	J-107	2068-8-6S	J-93	2083-24-24S	J-61
2050-20-20S	J-67	2062-8-6S	J-107	2068-8-8S	J-93	2083-32-32S	J-61
2050-2-2S	J-67	2062-8-8S	J-107	2070-10-10S	J-97	2083-4-2S	J-16
2050-4-4S	J-67	2063-10-12S	J-136	2070-12-12S	J-97	2083-4-4S	J-16
2050-4-6S	J-67	2063-12-10S	J-136	2070-14-14S	J-97	2083-6-2S	J-16
2050-6-6S	J-67	2063-12-12S	J-136	2070-16-16S	J-97	2083-6-4S	J-16
2050-6-8S	J-67	2063-16-16S	J-136	2070-20-20S	J-97	2083-6-6S	J-61
2050-8-8S	J-67	2063-2-4S	J-136	2070-4-4S	J-97	2083-8-4S	J-61
2056-10-10S	J-103	2063-4-4S	J-136	2070-5-5S	J-97	2083-8-6S	J-61
2060-10-10B	J-103	2063-4-5S	J-136	2070-6-6S	J-97	2083-8-8S	J-61
2060-12-12B	J-103	2063-4-6S	J-136	2070-8-8S	J-97	2084-12S-1 3/8	J-63
2060-4-4B	J-103	2063-6-6S	J-136	2071-10-10S	J-98	2084-16S-1 1/2	J-63
2060-5-5B	J-103	2063-6-8S	J-136	2071-10-8S	J-98	2084-20S-1 5/8	J-63
2060-6-6B	J-103	2063-8-10S	J-136	2071-12-12S	J-98	2084-24S-1 3/4	J-63
2060-8-8B	J-103	2063-8-8S	J-136	2071-14-14S	J-98	2084-2S-2	J-63
2061-10-10S	J-106	2066-12-10S	J-91	2071-16-16S	J-98	2084-2S-3/4	J-63
2061-10-12S	J-106	2066-12-12S	J-91	2071-20-20S	J-98	2084-4S-2	J-63
2061-10-8S	J-106	2066-12-14S	J-91	2071-24-24S	J-98	2084-4S-3	J-63
2061-12-10S	J-106	2066-12-16S	J-91	2071-32-32S	J-98	2084-4S-4	J-63
2061-12-12S	J-106	2066-12-8S	J-91	2071-4-4S	J-98	2084-4S-7/8	J-63
2061-12-16S	J-106	2066-16-16S	J-91	2071-4-6S	J-98	2084-6S-1	J-63
2061-12-8S	J-106	2066-16-20S	J-91	2071-5-5S	J-98	2084-6S-2	J-63
2061-14-14S	J-106	2066-20-20S	J-91	2071-6-4S	J-98	2084-6S-3	J-63
2061-16-12S	J-106	2066-24-24S	J-91	2071-6-6S	J-98	2084-6S-4	J-63
2061-16-16S	J-106	2066-4-4S	J-91	2071-8-10S	J-98	2084-6S-6	J-63
2061-16-20S	J-106	2066-4-5S	J-91	2071-8-6S	J-98	2084-8S-1 1/8	J-63
2061-20-16S	J-106	2066-4-6S	J-91	2071-8-8S	J-98	2084-8S-2 1/2	J-63
2061-20-20S	J-106	2066-4-8S	J-91	2080-12-12S	J-76	2085-12-12S	J-69
2061-4-4S	J-106	2066-6-10S	J-91	2080-16-16S	J-76	2085-12-8S	J-69
2061-5-5S	J-106	2066-6-4S	J-91	2080-2-2S	J-76	2085-16-12S	J-69
2061-6-4S	J-106	2066-6-6S	J-91	2080-4-4S	J-76	2085-16-16S	J-69
2061-6-6S	J-106	2066-6-8S	J-91	2080-6-6S	J-76	2085-2-2S	J-69
2061-6-8S	J-106	2066-8-10S	J-91	2080-8-8S	J-76	2085-4-4S	J-69
2061-8-10S	J-106	2066-8-12S	J-91	2081-12-4S	J-63	2085-6-4S	J-69
2061-8-6S	J-106	2066-8-6S	J-91	2081-12-6S	J-63	2085-6-6S	J-69

Part number	page	Part number	page	Part number	page	Part number	page
2085-8-6S	J-69	2096-20S	J-67	210292-3S	J-96	221501-16-6S	J-97
2085-8-8S	J-69	2096-24S	J-67	210292-4S	J-96	2215-10-4S	J-96
2086-12-12S	J-69	2096-2S	J-67	210292-5S	J-96	2215-10-6S	J-96
2086-16-16S	J-69	2096-32S	J-67	210292-6S	J-96	2215-10-8S	J-96
2086-4-4S	J-69	2096-4-2S	J-67	210292-8S	J-96	2215-12-10S	J-96
2086-6-6S	J-69	2096-4S	J-67	210294-10S	J-120	2215-14-8S	J-96
2086-8-8S	J-69	2096-6-4S	J-67	210294-12S	J-120	2215-16-10S	J-96
2087-12-12S	J-73	2096-6S	J-67	210294-14S	J-120	2215-16-8S	J-96
2087-12-8S	J-73	2096-8-4S	J-67	210294-16S	J-120	2215-20-16S	J-96
2087-16-12S	J-73	2096-8-6S	J-67	210294-4S	J-120	2215-24-16S	J-96
2087-16-16S	J-73	2096-8S	J-67	210294-6S	J-120	2215-24-20S	J-96
2087-20-20S	J-73	20CA12-12	F-5, K-16	210294-8S	J-120	2215-24-32S	J-96
2087-2-2S	J-73	20-F00	H-92	2104-1	H-94	2215-32-24S	J-96
2087-24-24S	J-73	20Z-070	H-32	2104-2	H-94	2215-6-5S	J-96
2087-4-2S	J-73	20Z-116	H-31	2105	H-94	2216-12-10S	J-92
2087-4-4S	J-73	20Z-120	H-31	21304N-102	I-20	2216-12-12S	J-92
2087-6-4S	J-73	20Z-170	H-49	21304N-104	I-20	2216-12-14S	J-92
2087-6-6S	J-73	20Z-20L	H-50	21304N-604	I-21	2216-12-16S	J-92
2087-8-6S	J-73	20Z-35A	H-52	21304N-664	I-22	2216-16-16S	J-92
2087-8-8S	J-73	20Z-35C	H-51	21304N-684	I-22	2216-16-20S	J-92
2088-12-12S	J-68	20Z-370	H-48	21304N-B04	I-20	2216-20-20S	J-92
2088-16-16S	J-68	20Z-520	H-36	21304N-E04	I-22	2216-24-24S	J-92
2088-2-2S	J-68	20Z-60P	H-49	21304N-E44	I-21	2216-2-4S	J-92
2088-4-4S	J-68	20Z-616	H-33	21305N-104	I-20	2216-2-5S	J-92
2088-6-6S	J-68	20Z-620	H-33	21305N-605	I-21	2216-32-32S	J-92
2088-8-8S	J-68	20Z-657	H-35	21305N-665	I-22	2216-4-10S	J-92
2089-12-12S	J-70	20Z-677	H-35	21305N-685	I-22	2216-4-4S	J-92
2089-12-8S	J-70	20Z-697	H-34	21305N-B05	I-20	2216-4-5S	J-92
2089-16-16S	J-70	20Z-770	H-41	21305N-E05	I-22	2216-4-6S	J-92
2089-20-20S	J-70	20Z-85D	H-51	21305N-E45	I-21	2216-4-8S	J-92
2089-2-2S	J-70	20Z-88C	H-52	21306N-106	I-20	2216-6-10S	J-92
2089-24-24S	J-70	20Z-90P	H-49	21306N-406	I-21	2216-6-12S	J-92
2089-2-4S	J-70	20Z-A40	H-38	21306N-466	I-22	2216-6-6S	J-92
2089-32-32S	J-70	20Z-A44	H-38	21306N-486	I-22	2216-6-8S	J-92
2089-4-2S	J-70	20Z-A80	H-39	21306N-606	I-21	2216-8-10S	J-92
2089-4-4S	J-70	20Z-A84	H-39	21306N-666	I-22	2216-8-12S	J-92
2089-4-6S	J-70	20Z-E80	H-40	21306N-686	I-22	2216-8-16S	J-92
2089-6-4S	J-70	20Z-G16	H-43	21306N-B04	I-20	2216-8-6S	J-92
2089-6-6S	J-70	20Z-G20	H-43	21306N-B05	I-20	2216-8-8S	J-92
2089-6-8S	J-70	20Z-G24	H-43	21306N-B06	I-20	2220-10-10S	J-59
2089-8-12S	J-70	20Z-G32	H-43	21306N-E04	I-22	2220-12-12S	J-59
2089-8-6S	J-70	20Z-G46	H-44	21306N-E05	I-22	2220-16-16S	J-59
2089-8-8S	J-70	20Z-G50	H-44	21306N-E06	I-22	2220-20-20S	J-59
2090-12-12S	J-76	20Z-G54	H-44	21306N-E44	I-21	2220-24-24S	J-59
2090-16-16S	J-76	20Z-G76	H-45	21306N-E45	I-21	2220-4-4S	J-59
2090-20-20S	J-76	20Z-G80	H-45	21306N-E46	I-21	2220-6-6S	J-59
2090-2-2S	J-76	20Z-G84	H-45	21308N-108	I-20	222070	I-8
2090-24-24S	J-76	20Z-H04	H-44	21308N-608	I-21	222070-8	I-8
2090-4-4S	J-76	20Z-H60	H-45	21308N-668	I-22	2220-8-8S	J-59
2090-6-6S	J-76	20Z-H64	H-45	21308N-688	I-22	2222-1S	J-65
2090-8-8S	J-76	20Z-J50	H-39	21308N-B08	I-20	2222-2S	J-65
2091-12-12S	J-76	20Z-L80	H-38	21308N-E08	I-22	2222-4S	J-65
2091-16-16S	J-76	20Z-L84	H-38	21308N-E48	I-21	2222-6S	J-65
2091-2-2S	J-76	20Z-P20	H-40	21310N-108	I-20	2229-16-16S	J-60
2091-4-4S	J-76	20Z-P67	H-50	21310N-610	I-21	2229-8-8S	J-60
2091-6-6S	J-76	20Z-S80	H-37	21312N-112	I-20	2239-1-12-12S	J-79
2091-8-8S	J-76	20Z-S84	H-37	21312N-412	I-21	2239-1-16-16S	J-79
2092-12-12S	J-74	210212-10S	J-102	21312N-612	I-21	2239-1-2-4S	J-79
2092-16-16S	J-74	210212-12S	J-102	21316N-116	I-20	2239-1-4-6S	J-79
2092-20-20S	J-74	210212-16S	J-102	21316N-616	I-21	2239-1-6-8S	J-79
2092-2-2S	J-74	210212-20S	J-102	21316N-X26	I-21	2239-1-8-10S	J-79
2092-4-4S	J-74	210212-24S	J-102	22012-XX	J-113	2240-12-12S	J-78
2092-6-6S	J-74	210212-3S	J-102	22033-XX	J-113	2240-16-16S	J-78
2092-8-8S	J-74	210212-4S	J-102	22046-XX	J-113	2240-2-4S	J-78
2093-12-12S	J-74	210212-5S	J-102	22046-XXX	J-111	2240-4-4S	J-78
2093-16-16S	J-74	210212-6S	J-102	22068-XX	J-113	2240-4-6S	J-78
2093-2-2S	J-74	210212-8S	J-102	221000-10S	J-126	2240-6-8S	J-78
2093-4-4S	J-74	210292-10S	J-96	221000-12S	J-126	2240-8-10S	J-78
2093-6-6S	J-74	210292-12S	J-96	221000-14S	J-126	2242-12-12S	J-79
2093-8-8S	J-74	210292-16S	J-96	221000-16S	J-126	2242-12-14S	J-79
2096-12-8S	J-67	210292-20S	J-96	221000-4S	J-126	2242-16-16S	J-79
2096-12S	J-67	210292-24S	J-96	221000-5S	J-126	2242-20-20S	J-79
2096-16-12S	J-67	210292-2S	J-96	221000-6S	J-126	2242-2-4S	J-79
2096-16S	J-67	210292-32S	J-96	221000-8S	J-126	2242-2-5S	J-79

Index

Part number index

M

Part number	page	Part number	page	Part number	page	Part number	page
2242-4-4S	J-79	2255-12-12S	J-75	24706N-106	I-23	24Z-G24	H-43
2242-4-5S	J-79	2255-2-2S	J-75	24706N-306	I-24	24Z-G32	H-43
2242-4-6S	J-79	2255-4-4S	J-75	24706N-406	I-25	24Z-G54	H-44
2242-6-6S	J-79	2255-6-6S	J-75	24706N-444	I-27	24Z-G62	H-44
2242-6-8S	J-79	2255-8-8S	J-75	24706N-446	I-27	24Z-G80	H-45
2242-8-10S	J-79	2256-12-12S	J-74	24706N-466	I-27	24Z-G84	H-45
2242-8-6S	J-79	2256-16-16S	J-74	24706N-484	I-26	24Z-G92	H-45
2242-8-8S	J-79	2256-2-2S	J-74	24706N-486	I-26	24Z-H55	H-45
2243-8-10S	J-81	2256-4-4S	J-74	24706N-506	I-23	24Z-L84	H-38
2243-8-6S	J-81	2256-6-6S	J-74	24706N-604	I-25	24Z-P24	H-40
2244-6-6S	J-85	2256-8-8S	J-74	24706N-605	I-25	24Z-S84	H-37
2244-8-10S	J-85	2257-12-12S	J-73	24706N-606	I-25	259-1290-10	J-127
2244-8-8S	J-85	2257-16-16S	J-73	24706N-608	I-25	259-1290-12	J-127
2246-12-12S	J-91	2257-2-2S	J-73	24706N-646	I-27	259-1290-16	J-127
2246-12-14S	J-91	2257-4-4S	J-73	24706N-666	I-27	259-1290-20	J-127
2246-16-16S	J-91	2257-6-6S	J-73	24706N-686	I-26	259-1290-24	J-127
2246-2-4S	J-91	2257-8-8S	J-73	24706N-754	I-25	259-1290-32	J-127
2246-2-5S	J-91	22617-1	J-112	24706N-755	I-25	259-1290-4	J-127
2246-4-6S	J-91	22617-10	J-112	24706N-756	I-25	259-1290-6	J-127
2246-6-6S	J-91	22617-12	J-112	24706N-758	I-25	259-1290-8	J-127
2246-6-8S	J-91	22617-14	J-112	24706N-B06	I-24	259-2021-12-10	J-77
2246-8-10S	J-91	22617-16	J-112	24706N-B24	I-24	259-2021-12-12	J-77
2246-8-6S	J-91	22617-2	J-112	24706N-B25	I-24	259-2021-12-16	J-77
2246-8-8S	J-91	22617-20	J-112	24706N-B26	I-24	259-2021-12-8	J-77
2247-12-12S	J-67	22617-24	J-112	24706N-E04	I-26	259-2021-16-16	J-77
2247-16-16S	J-67	22617-3	J-112	24706N-E05	I-26	259-2021-20-16	J-77
2247-20-20S	J-67	22617-4	J-112	24706N-E06	I-26	259-2021-20-20	J-77
2247-2-2S	J-67	22617-5	J-112	24706N-T56	I-25	259-2021-20-24	J-77
2247-4-4S	J-67	22617-6	J-112	24708N-106	I-23	259-2021-2-4	J-77
2247-6-4S	J-67	22617-7	J-112	24708N-108	I-23	259-2021-24-24	J-77
2247-6-6S	J-67	22617-8	J-112	24708N-308	I-24	259-2021-32-32	J-77
2247-8-8S	J-67	22617-XX	J-112	24708N-406	I-25	259-2021-4-4	J-77
2249-12-12S	J-84	22617-XX	J-113	24708N-508	I-23	259-2021-4-5	J-77
2249-4-6S	J-84	2266-10-10S	J-105	24708N-608	I-25	259-2021-4-6	J-77
2249-6-8S	J-84	2266-12-12S	J-105	24708N-648	I-27	259-2021-4-8	J-77
2249-8-10S	J-84	2266-12-16S	J-105	24708N-668	I-27	259-2021-6-10	J-77
2250-12-12S	J-84	2266-16-16S	J-105	24708N-688	I-26	259-2021-6-4	J-77
2250-12-14S	J-84	2266-20-20S	J-105	24708N-B08	I-24	259-2021-6-6	J-77
2250-12-8S	J-84	2266-24-24S	J-105	24708N-T58	I-25	259-2021-6-8	J-77
2250-16-16S	J-84	2266-4-4S	J-105	24710N-108	I-23	259-2021-8-10	J-77
2250-20-20S	J-84	2266-6-4S	J-105	24710N-112	I-23	259-2021-8-12	J-77
2250-24-24S	J-84	2266-6-6S	J-105	24710N-310	I-24	259-2021-8-6	J-77
2250-2-4S	J-84	2266-6-8S	J-105	24710N-510	I-23	259-2021-8-8	J-77
2250-2-5S	J-84	2266-8-6S	J-105	24710N-608	I-25	259-2021-16-16	J-80
2250-32-32S	J-84	2266-8-8S	J-105	24710N-610	I-25	259-2022-4-4	J-80
2250-4-4S	J-84	22904P-404	H-24	24710N-650	I-27	259-2022-6-6	J-80
2250-4-6S	J-84	22906P-406	H-24	24710N-668	I-27	259-2022-6-8	J-80
2250-6-8S	J-84	22908P-408	H-24	24710N-670	I-27	259-2022-8-8	J-80
2250-8-10S	J-84	22910P-410	H-24	24710N-690	I-26	259-2023-4-6	J-81
2251-12-12S	J-70	24-124	H-91	24712N-112	I-23	259-2024-16-16	J-82
2251-4-4S	J-70	24-624	H-92	24712N-312	I-24	259-2024-2-4	J-82
2251-6-6S	J-70	24704N-102	I-23	24712N-412	I-25	259-2024-4-4	J-82
2251-8-8S	J-70	24704N-104	I-23	24712N-452	I-27	259-2024-4-6	J-82
2252-12-12S	J-71	24704N-304	I-24	24712N-472	I-27	259-2024-8-8	J-82
2252-2-2S	J-71	24704N-504	I-23	24712N-492	I-26	259-202702-12-12	J-104
2252-4-4S	J-71	24704N-604	I-25	24712N-512	I-23	259-202702-16-16	J-104
2252-6-6S	J-71	24704N-644	I-27	24712N-612	I-25	259-202702-16-8	J-104
2252-8-8S	J-71	24704N-664	I-27	24712N-652	I-27	259-202702-4-4	J-104
2253-12-12S	J-75	24704N-684	I-26	24712N-672	I-27	259-202702-6-6	J-104
2253-6-6S	J-75	24704N-B04	I-24	24712N-692	I-26	259-202702-8-6	J-104
2253-8-8S	J-75	24704N-E04	I-26	24716N-516	I-23	259-202702-8-8	J-104
2254-12-12S	J-75	24704N-T54	I-25	24716N-616	I-25	259-2027-12-12	J-94
2254-2-2S	J-75	24705N-104	I-23	24716N-656	I-27	259-2027-16-16	J-94
2254-4-4S	J-75	24705N-305	I-24	24716N-676	I-27	259-2027-4-4	J-94
2254-4-6S	J-75	24705N-505	I-23	24716N-696	I-26	259-2027-6-6	J-94
2254-4-8S	J-75	24705N-605	I-25	24-F00	H-92	259-2027-8-8	J-94
22546-11	I-31	24705N-645	I-27	24-S24	H-92	259-2041-1-8-8	J-95
22546-13	I-31	24705N-665	I-27	24Z-124	H-31	259-2071-4-4	J-98
22546-15	I-31	24705N-685	I-26	24Z-524	H-36	259-2071-6-6	J-98
22546-17	I-31	24705N-B05	I-24	24Z-624	H-33	259-2081-12-4	J-63
2254-6-6S	J-75	24705N-E05	I-26	24Z-678	H-35	259-2081-16-12	J-63
2254-6-8S	J-75	24705N-E45	I-26	24Z-A40	H-38	259-2081-16-8	J-63
22546-XX	J-113	24705N-T55	I-25	24Z-A44	H-38	259-2081-20-12	J-63
2254-8-8S	J-75	24706N-104	I-23	24Z-A84	H-39	259-2081-20-16	J-63

Part number	page	Part number	page	Part number	page	Part number	page
259-2081-32-16	J-63	2RA12MJ12	I-5	3130-16-200BX	B-29	33806-C	I-16
259-2081-32-20	J-63	2RA12MP12	I-5	32-132	H-91	33806-D	I-17
259-2081-4-2	J-63	2RA12MP16	I-5	32-632	H-92	33806-E	I-16
259-2081-6-2	J-63	2RA16	I-5 - I-7	3270-06	F-8	33806P-104	H-27
259-2081-6-4	J-63	2RA16FJ16	I-5	3270-06104	F-8	33806P-106	H-27
259-2081-8-4	J-63	2RA16FJA16	I-6	3270-06124	F-8	33806P-108	H-27
259-2081-8-6	J-63	2RA16FJB16	I-6	3270-06134	F-8	33806P-406	H-27
259-2082-16	J-64	2RA16FJC16	I-6	3270-06144	F-8	33806P-J06	H-27
259-2082-2	J-64	2RA16FR16	I-7	3270-06154	F-8	33806P-Y66	H-27
259-2082-4	J-64	2RA16FRA16	I-7	3270-06164	F-8	33806P-Y68	H-27
259-2082-6	J-64	2RA16FRB16	I-7	3270-08	F-8	33806P-Y76	H-28
259-2083-12-12	J-61	2RA16FRC16	I-7	3270-08104	F-8	33808-A	I-17
259-2083-16-16	J-61	2RA16MJ16	I-5	3270-08124	F-8	33808-B	I-17
259-2083-20-20	J-61	2RA4	I-5 - I-7	3270-08134	F-8	33808B-Y08	I-16
259-2083-2-2	J-61	2RA4FJ4	I-5	3270-08144	F-8	33808B-Y26	I-15
259-2083-24-24	J-61	2RA4FJA4	I-6	3270-08154	F-8	33808B-Y28	I-15
259-2083-4-2	J-61	2RA4FJB4	I-6	3270-08164	F-8	33808B-Y36	I-15
259-2083-4-4	J-61	2RA4FJC4	I-6	3270-10	F-8	33808B-Y38	I-15
259-2083-6-4	J-61	2RA4FR4	I-7	3270-10103	F-8	33808B-Y78	I-15
259-2083-6-6	J-61	2RA4FRA4	I-7	3270-10123	F-8	33808B-Y86	I-16
259-2083-8-8	J-61	2RA4FRB4	I-7	3270-10133	F-8	33808-C	I-16
259-2087-4-4	J-73	2RA4FRC4	I-7	3270-10143	F-8	33808-D	I-17
259-2089-6-6	J-70	2RA4MJ4	I-5	3270-10153	F-8	33808P-106	H-27
259-2096-12	J-67	2RA4MP4	I-5	3270-10163	F-8	33808P-108	H-27
259-2096-20	J-67	2RA6	I-5 - I-7	3270-12	F-8	33808P-408	H-27
259-2096-4	J-67	2RA6FJ6	I-5	3270-12103	F-8	33808P-Y68	H-27
259-2096-4-2	J-67	2RA6FJA6	I-6	3270-12123	F-8	33808P-Y76	H-28
259-2096-6	J-67	2RA6FJB6	I-6	3270-12133	F-8	33808P-Y78	H-28
259-2096-8	J-67	2RA6FJC6	I-6	3270-12153	F-8	35FH-40201-001	F-23
259-210212-12	J-102	2RA6FR6	I-7	3270-12163	F-8	35FH-40203-001	F-23
259-210212-6	J-102	2RA6FRA6	I-7	32706E-606	H-13	35FH-50203-001	F-23
259-210212-8	J-102	2RA6FRB6	I-7	32706E-666	H-13	35FH-50207-001	F-23
259-210292-4	J-96	2RA6FRC6	I-7	32706E-686	H-13	35FH-60203-001	F-23
259-210292-8	J-96	2RA6MJ6	I-5	32706E-A26	H-14	35FH-60206-001	F-23
259-900599-12	J-95	2RA6MP6	I-5	32706E-L66	H-14	35NG-0404-250BX	F-30
259-900599-6	J-95	2RA6MP8	I-5	32706E-S66	H-14	35NG-0406-250BX	F-30
259-900605-10	J-127	2RA8	I-5 - I-7	32708E-608	H-13	35NG-0408-250BX	F-30
259-900605-12	J-127	2RA8FJ8	I-5	32708E-668	H-13	35NG-04-250BX	F-30
259-900605-16	J-127	2RA8FJA8	I-6	32708E-688	H-13	35NG-06-250BX	F-30
259-900605-20	J-127	2RA8FJB8	I-6	32708E-A28	H-14	35NG-08-250BX	F-30
259-900605-24	J-127	2RA8FJC8	I-6	32708E-L68	H-14	3740-04-250BX	B-30
259-900605-4	J-127	2RA8FR8	I-7	32708E-S68	H-14	3740-04-250RC	B-30
259-900605-6	J-127	2RA8FRA8	I-7	32710E-610	H-13	3740-04-500R	B-30
259-900605-8	J-127	2RA8FRB8	I-7	32710E-670	H-13	3740-05-250BX	B-30
26504P-102	H-25	2RA8FRC8	I-7	32710E-690	H-13	3740-05-250R	B-30
26504P-104	H-25	2RA8MJ8	I-5	32710E-A30	H-14	3740-05-250RC	B-30
26504P-106	H-25	2RA8MP8	I-5	32710E-S70	H-14	3740-06-250BX	B-30
26504P-202	H-25	307-2045-4-4	J-66	32712E-612	H-13	3740-06-250RC	B-30
26504P-204	H-25	307-2082-24	J-64	32712E-672	H-13	3740-06-500R	B-30
26506P-102	H-25	307-2082-8	J-64	32712E-692	H-13	3740-08-250BX	B-30
26506P-104	H-25	30CT-03-250BX	B-33	32712E-L72	H-14	3740-08-250RC	B-30
26506P-106	H-25	30CT-04-2-250BX	B-36	32712E-S72	H-14	3740-08-500R	B-30
26506P-108	H-25	30CT-04-250BX	B-33	32-F00	H-92	3740-12-200BX	B-30
26506P-202	H-25	30CT-05-2-250BX	B-36	32-S32	H-92	3740-12-200RC	B-30
26506P-204	H-25	30CT-05-250BX	B-33	32Z-132	H-31	3740-16-050BX	B-30
26506P-206	H-25	30CT-06-2-250BX	B-36	32Z-632	H-33	37AL-03-250BX	B-31
26508P-104	H-25	30CT-06-250BX	B-33	32Z-G32	H-43	37AL-04-2-250BX	B-36
26508P-106	H-25	30CT-08-2-250BX	B-36	32Z-G33	H-43	37AL-04-250BX	B-31
26508P-108	H-25	30CT-08-250BX	B-33	32Z-G54	H-44	37AL-04-500RC	B-31
26508P-112	H-25	30CT-10-250BX	B-33	32Z-G62	H-44	37AL-05-250BX	B-31
26508P-204	H-25	3130-02-250BX	B-29	32Z-G92	H-45	37AL-05-500RC	B-31
26508P-206	H-25	3130-03-250BX	B-29	32Z-G93	H-45	37AL-06-2-250BX	B-36
26508P-208	H-25	3130-04-2-250BX	B-36	33806-A	I-17	37AL-06-250BX	B-31
26512P-108	H-25	3130-04-250BX	B-29	33806-B	I-17	37AL-06-500RC	B-31
26512P-112	H-25	3130-04-500R	B-29	33806B-Y06	I-16	37AL-08-2-250BX	B-36
2RA12	I-5 - I-7	3130-05-2-250BX	B-36	33806B-Y24	I-15	37AL-08-250BX	B-31
2RA12FJ12	I-5	3130-05-250BX	B-29	33806B-Y26	I-15	37AL-08-500RC	B-31
2RA12FJA12	I-6	3130-06-2-250BX	B-36	33806B-Y28	I-15	38097-01800	K-19
2RA12FJB12	I-6	3130-06-250BX	B-29	33806B-Y34	I-15	38097-02000	K-19
2RA12FJC12	I-6	3130-06-500R	B-29	33806B-Y36	I-15	38097-02400	K-19
2RA12FR12	I-7	3130-08-2-250BX	B-36	33806B-Y38	I-15	38097-02600	K-19
2RA12FRA12	I-7	3130-08-250BX	B-29	33806B-Y76	I-15	38097-02800	K-19
2RA12FRB12	I-7	3130-08-500R	B-29	33806B-Y84	I-16	38097-03000	K-19
2RA12FRC12	I-7	3130-12-200BX	B-29	33806B-Y86	I-16	38097-03200	K-19

Index

Part number index

M

Part number	page	Part number	page	Part number	page	Part number	page
38097-03400	K-19	4103-4-8-8S	I-2, I-5	4S10DL6	H-86	4S16CTG16	H-80
38097-04000	K-19	4202-12-12S	I-2, I-5	4S10DS6	H-87	4S16DL10	H-86
38097-04200	K-19	4202-16-16S	I-2, I-5	4S10DSB6	H-88	4S16DS10	H-87
38097-06000	K-19	4202-2-4S	I-2	4S10FR10	H-65	4S16DS12	H-87
38097-07200	K-19	4202-4-4S	I-2, I-5	4S10FRB10	H-67	4S16DSA10	H-88
38166-01812	K-19	4202-4-6S	I-2	4S10FRB10.047	H-67	4S16DSB10	H-88
38166-02137	K-19	4202-6-6S	I-2, I-5	4S10KF10	H-86	4S16EK10	H-87
38166-02200	K-19	4202-6-8S	I-2, I-5	4S12BF12	H-83	4S16FH12	H-74
38166-02412	K-19	4202-8-8S	I-2, I-5	4S12BFA12	H-84	4S16FH16	H-74
38166-02487	K-19	4203-12S	I-2, I-5	4S12BFB12	H-85	4S16FH20	H-74
38166-02600	K-19	4203-16S	I-2, I-5	4S12BP12	H-83	4S16FHA12	H-75
38166-02762	K-19	4203-4-4S	I-2, I-5	4S12BT12	H-82	4S16FHA16	H-75
38166-02837	K-19	4203-6-6S	I-2, I-5	4S12CT12	H-78	4S16FHB12	H-77
38166-02912	K-19	4203-8-8S	I-2, I-5	4S12CTA12	H-79	4S16FHB16	H-77
38166-03012	K-19	4245-02	F-6, F-7	4S12CTB12	H-81	4S16FHB16.120	H-77
38166-03200	K-19	4245-02207	F-6	4S12CTD12	H-79	4S16FHB20	H-77
38166-03400	K-19	4245-02227	F-6	4S12CTE12	H-82	4S16FHD16	H-74
38166-03437	K-19	4245-02257	F-6	4S12CTF12	H-80	4S16FHG16	H-76
38166-03612	K-19	4245-02267	F-6	4S12CTG12	H-80	4S16FL12	H-69
38166-03812	K-19	4245-02506	F-6	4S12DL8	H-86	4S16FL16	H-69
38166-04000	K-19	4245-02526	F-6	4S12DS8	H-87	4S16FL20	H-69
38166-04112	K-19	4245-02546	F-6	4S12DSA8	H-88	4S16FLA12	H-71
38166-04200	K-19	4245-02556	F-6	4S12DSB8	H-88	4S16FLA16	H-71
38166-04800	K-19	4245-02566	F-6	4S12EK8	H-87	4S16FLA20	H-71
38166-06000	K-19	4245-03	F-6, F-7	4S12FH10	H-74	4S16FLB12	H-73
38166-07200	K-19	4245-03306	F-6	4S12FH12	H-74	4S16FLB16	H-73
38353-01500	K-19	4245-03326	F-6	4S12FH16	H-74	4S16FLB16.116	H-73
38353-01600	K-19	4245-03356	F-6	4S12FH8	H-74	4S16FLB20	H-73
38353-01800	K-19	4245-05	F-6, F-7	4S12FHA12	H-75	4S16FLD12	H-70
38353-01900	K-19	4245-05204	F-7	4S12FHA16	H-75	4S16FLD16	H-70
38353-02037	K-19	4245-05224	F-7	4S12FHA8	H-75	4S16FLE12	H-72
38353-02200	K-19	4245-05244	F-7	4S12FHB12	H-77	4S16FLE16	H-72
38353-02300	K-19	4245-05254	F-7	4S12FHB8	H-77	4S16FLF12	H-70
38353-02400	K-19	4245-05264	F-7	4S12FHG12	H-76	4S16FLF16	H-70
38353-02600	K-19	4247-04	F-6, F-7	4S12FL10	H-69	4S16FLG12	H-72
38353-02837	K-19	4247-04106	F-7	4S12FL12	H-69	4S16FLG16	H-72
38353-03000	K-19	4247-04126	F-7	4S12FL8	H-69	4S16FLH16	H-73
38353-03200	K-19	4247-04136	F-7	4S12FLA10	H-71	4S16JF16	H-85
38353-03437	K-19	4247-04146	F-7	4S12FLA12	H-71	4S16KF16	H-86
38353-03600	K-19	4247-04156	F-7	4S12FLA16	H-71	4S20BF16	H-83
38353-04112	K-19	4247-04166	F-7	4S12FLA8	H-71	4S20BF20	H-83
38353-04400	K-19	4294-06	F-9	4S12FLB10	H-73	4S20BFA16	H-84
38353-04600	K-19	4294-07	F-9	4S12FLB12	H-73	4S20BFA20	H-84
38353-04800	K-19	4294-08	F-9	4S12FLB8	H-73	4S20BFB16	H-85
38353-06000	K-19	4294-0810K	F-11	4S12FLD12	H-70	4S20BFB20	H-85
38353-07200	K-19	4294-081FK	F-11	4S12FLD8	H-70	4S20BP20	H-83
3E80-03-050BX	B-32	4294-10	F-9	4S12FLE12	H-72	4S20BT20	H-82
3E80-04-250BX	B-32	4297-06	F-10	4S12FLE8	H-72	4S20CT16	H-78
3E80-06-250BX	B-32	4297-07	F-10	4S12FLF12	H-70	4S20CT20	H-78
3E80-08-250BX	B-32	4297-08	F-10	4S12FLG12	H-72	4S20CTA16	H-79
3R80-03-250BX	B-32	4297-10	F-10	4S12FLG8	H-72	4S20CTA20	H-79
3R80-04-250BX	B-32	4297-101FX-001	F-11	4S12FR10	H-65	4S20CTB16	H-81
3R80-06-250BX	B-32	4297-M10	F-10	4S12FRB10	H-67	4S20CTB20	H-81
3R80-08-250BX	B-32	4297-M12	F-10	4S12FRB10.058	H-67	4S20CTD16	H-79
3R80-12-200BX	B-32	4408-08310	F-11	4S12FRC10	H-68	4S20CTD20	H-79
3R80-16-200BX	B-32	4408-08610	F-11	4S12JF12	H-85	4S20CTE16	H-82
3SCE-0303304-033	F-5, K-17	4408-08710	F-11	4S12KF12	H-86	4S20CTE20	H-82
3SCE-0303304-166	F-5, K-17	4408-10310	F-11	4S16BF12	H-83	4S20CTF16	H-80
3V10-03	B-34	4408-10610	F-11	4S16BF16	H-83	4S20CTF20	H-80
3V10-03-250BX	B-34	4408-10710	F-11	4S16BFA12	H-84	4S20CTG16	H-80
3V10-04	B-34	4624-12-16S	J-121	4S16BFA16	H-84	4S20CTG20	H-80
3V10-04-250BX	B-34	4624-12S	J-121	4S16BFB12	H-85	4S20DL12	H-86
3V10-06	B-34	4624-16-12S	J-121	4S16BFB16	H-85	4S20DLB12	H-86
3V10-06-250BX	B-34	4624-16-20S	J-121	4S16BP16	H-83	4S20DS12	H-87
3VE0-03	B-35	4624-16S	J-121	4S16BT16	H-82	4S20DSA12	H-88
3VE0-03-250BX	B-35	4624-20-16S	J-121	4S16CT12	H-78	4S20DSB12	H-88
3VE0-04	B-35	4624-20S	J-121	4S16CT16	H-78	4S20EK12	H-87
3VE0-04-250BX	B-35	4624-24-16S	J-121	4S16CTA12	H-79	4S20FH16	H-74
3VE0-06	B-35	4624-24-20S	J-121	4S16CTA16	H-79	4S20FH20	H-74
3VE0-06-250BX	B-35	4624-24S	J-121	4S16CTB12	H-81	4S20FHA16	H-75
4103-4-12S	I-2, I-5	4624-32-16S	J-121	4S16CTB16	H-81	4S20FHA20	H-75
4103-4-16S	I-2, I-5	4624-32-24S	J-121	4S16CTD16	H-79	4S20FHB16	H-77
4103-4-4-4S	I-2, I-5	4624-32S	J-121	4S16CTE16	H-82	4S20FHB20	H-77
4103-4-6-6S	I-2, I-5	4624-40-32S	J-121	4S16CTF16	H-80	4S20FHB20.120	H-77

Part number	page	Part number	page	Part number	page	Part number	page
4S20FHD16	H-74	4S32CTB32	H-81	4SA10FR12	H-65	4SA16MR16	H-64
4S20FL12	H-69	4S32CTD32	H-79	4SA10FR8	H-65	4SA16PS16	H-60
4S20FL16	H-69	4S32CTE32	H-82	4SA10FRA10	H-66	4SA20FJ16	H-61
4S20FL20	H-69	4S32CTF32	H-80	4SA10FRA8	H-66	4SA20FJ20	H-61
4S20FLA16	H-71	4S32CTG32	H-80	4SA10FRB10	H-67	4SA20FJA16	H-62
4S20FLA20	H-71	4S32DL20	H-86	4SA10FRB10.047	H-67	4SA20FJA20	H-62
4S20FLB12	H-73	4S32DLB20	H-86	4SA10FRB12	H-67	4SA20FJB16	H-63
4S20FLB16	H-73	4S32DS16	H-87	4SA10FRB8	H-67	4SA20FJB20	H-63
4S20FLB20	H-73	4S32DS20	H-87	4SA10FRC10	H-68	4SA20FJC20	H-63
4S20FLD16	H-70	4S32DSA16	H-88	4SA10FRC12	H-68	4SA20FR16	H-65
4S20FLD20	H-70	4S32DSA20	H-88	4SA10FRC8	H-68	4SA20FR20	H-65
4S20FLE16	H-72	4S32DSB16	H-88	4SA10FS8	H-64	4SA20FRA16	H-66
4S20FLE20	H-72	4S32DSB20	H-88	4SA10MB10	H-64	4SA20FRA20	H-66
4S20FLF16	H-70	4S32EK20	H-87	4SA10MB8	H-64	4SA20FRB16	H-67
4S20FLF20	H-70	4S32FH24	H-74	4SA10MJ10	H-60	4SA20FRB20	H-67
4S20FLG16	H-72	4S32FH32	H-74	4SA10MJ12	H-60	4SA20FRC20	H-68
4S20FLG20	H-72	4S32FHA24	H-75	4SA10MJ8	H-60	4SA20MB20	H-64
4S20JF20	H-85	4S32FHA32	H-75	4SA12FJ10	H-61	4SA20MJ16	H-60
4S20KF20	H-86	4S32FHB24	H-77	4SA12FJ12	H-61	4SA20MJ20	H-60
4S24BF24	H-83	4S32FHB32	H-77	4SA12FJ16	H-61	4SA20MP16	H-59
4S24BFA24	H-84	4S32FHD32	H-74	4SA12FJ8	H-61	4SA20MP20	H-59
4S24BFB24	H-85	4S32FHE32	H-76	4SA12FJA10	H-62	4SA20MR16	H-64
4S24CT20	H-78	4S32FHF32	H-75	4SA12FJA12	H-62	4SA20MR20	H-64
4S24CT24	H-78	4S32FHG32	H-76	4SA12FJB10	H-63	4SA24FJ20	H-61
4S24CTA20	H-79	4S32FL20	H-69	4SA12FJB12	H-63	4SA24FJA24	H-62
4S24CTA24	H-79	4S32FL24	H-69	4SA12FJC12	H-63	4SA24FJB24	H-63
4S24CTB20	H-81	4S32FL32	H-69	4SA12FJG12	H-62	4SA24FR24	H-65
4S24CTB24	H-81	4S32FLA24	H-71	4SA12FR10	H-65	4SA24FRA24	H-66
4S24CTD20	H-79	4S32FLA32	H-71	4SA12FR12	H-65	4SA24FRB20	H-67
4S24CTD24	H-79	4S32FLB24	H-73	4SA12FR16	H-65	4SA24FRB24	H-67
4S24CTE20	H-82	4S32FLB32	H-73	4SA12FRA10	H-66	4SA24FRC20	H-68
4S24CTE24	H-82	4S32FLD24	H-70	4SA12FRA12	H-66	4SA24FRC24	H-68
4S24CTF20	H-80	4S32FLD32	H-70	4SA12FRB10	H-67	4SA24MB24	H-64
4S24CTF24	H-80	4S32FLE24	H-72	4SA12FRB12	H-67	4SA24MJ24	H-60
4S24CTG20	H-80	4S32FLE32	H-72	4SA12FRB16	H-67	4SA24MP24	H-59
4S24CTG24	H-80	4S32FLF32	H-70	4SA12FRB18	H-67	4SA32FJ32	H-61
4S24FH20	H-74	4S32FLG32	H-72	4SA12FS12	H-64	4SA32MJ32	H-60
4S24FH24	H-74	4S6BF6	H-83	4SA12FS16	H-64	4SA32MP32	H-59
4S24FHA20	H-75	4S6BFA6	H-84	4SA12MB10	H-64	4SA4FJ6	H-61
4S24FHA24	H-75	4S6BFB6	H-85	4SA12MB12	H-64	4SA4FRA6	H-66
4S24FHB20	H-77	4S6EK6	H-87	4SA12MJ10	H-60	4SA4FS6	H-64
4S24FHB24	H-77	4S6JF6	H-85	4SA12MJ12	H-60	4SA4MP6	H-59
4S24FHF20	H-75	4S8BF8	H-83	4SA12MJ8	H-60	4SA4MP8	H-59
4S24FL16	H-69	4S8BFA8	H-84	4SA12MP10	H-59	4SA6FJ6	H-61
4S24FL20	H-69	4S8BFB8	H-85	4SA12MP12	H-59	4SA6FJ8	H-61
4S24FL24	H-69	4S8DL6	H-86	4SA12MP16	H-59	4SA6FJ8	H-61
4S24FLA20	H-71	4S8DS6	H-87	4SA12MP8	H-59	4SA6FJA6	H-62
4S24FLA24	H-71	4S8DSA6	H-88	4SA12MR12	H-64	4SA6FJB6	H-63
4S24FLB16	H-73	4S8DSB6	H-88	4SA14FJ12	H-61	4SA6FJC6	H-63
4S24FLB20	H-73	4S8EK6	H-87	4SA14MJ12	H-60	4SA6FR6	H-65
4S24FLB24	H-73	4S8FH8	H-74	4SA16FJ12	H-61	4SA6FR8	H-65
4S24FLD20	H-70	4S8FHA8	H-75	4SA16FJ16	H-61	4SA6FRA6	H-66
4S24FLD24	H-70	4S8FHB8	H-77	4SA16FJ20	H-61	4SA6FRB6	H-67
4S24FLE20	H-72	4S8FL8	H-69	4SA16FJA12	H-62	4SA6FRB6.038	H-67
4S24FLE24	H-72	4S8FLA8	H-71	4SA16FJA16	H-62	4SA6FRB8	H-67
4S24FLF20	H-70	4S8FLB8	H-73	4SA16FJB12	H-63	4SA6FRC6	H-68
4S24FLF24	H-70	4S8FLD8	H-70	4SA16FJB16	H-63	4SA6FS6	H-64
4S24FLG20	H-72	4S8FLE8	H-72	4SA16FJC16	H-63	4SA6MB6	H-64
4S24FLG24	H-72	4S8FLF8	H-70	4SA16FJG16	H-62	4SA6MJ6	H-60
4S25DL16	H-86	4S8FLG8	H-72	4SA16FR12	H-65	4SA6MP6	H-59
4S25DS12	H-87	4S8FR10	H-65	4SA16FR16	H-65	4SA6MP8	H-59
4S25DS16	H-87	4S8FRA8	H-66	4SA16FRA12	H-66	4SA6MR6	H-64
4S25DS20	H-87	4S8FRC8	H-68	4SA16FRA16	H-66	4SA8FJ6	H-61
4S25DSA12	H-88	4S8JF8	H-85	4SA16FRB12	H-67	4SA8FJ8	H-61
4S25DSA16	H-88	4S8KF8	H-86	4SA16FRB16	H-67	4SA8FJA6	H-62
4S25DSB12	H-88	4SA10FJ10	H-61	4SA16FRC12	H-68	4SA8FJA8	H-62
4S25DSB16	H-88	4SA10FJ12	H-61	4SA16FRC16	H-68	4SA8FJB6	H-63
4S25EK16	H-87	4SA10FJ8	H-61	4SA16MB16	H-64	4SA8FJB8	H-63
4S32BF32	H-83	4SA10FJA10	H-62	4SA16MJ12	H-60	4SA8FJB8TZ	H-63
4S32BFA32	H-84	4SA10FJA8	H-62	4SA16MJ16	H-60	4SA8FR6	H-65
4S32BFB32	H-85	4SA10FJB10	H-63	4SA16MP12	H-59	4SA8FR8	H-65
4S32CT24	H-78	4SA10FJB8	H-63	4SA16MP16	H-59	4SA8FRA6	H-66
4S32CT32	H-78	4SA10FJC8	H-63	4SA16MP20	H-59	4SA8FRA8	H-66
4S32CTA32	H-79	4SA10FR10	H-65	4SA16MR12	H-64	4SA8FRA8.022	H-66

Index

Part number index

M

Part number	page	Part number	page	Part number	page	Part number	page
4SA8FRB6	H-67	6204-016	K-29	6S32CTD32	H-79	71418-24-24S	J-121
4SA8FRB8	H-67	6204-020	K-29	6S32CTE24	H-82	71418-32-32S	J-121
4SA8FRC6	H-68	6204-024	K-29	6S32CTE32	H-82	71418-40-40S	J-121
4SA8FRC8	H-68	6204-028	K-29	6S32CTF24	H-80	71422-20-20S	J-122
4SA8MB6	H-64	6204-032	K-29	6S32CTF32	H-80	7165x10	J-144
4SA8MB8	H-64	6204-036	K-29	6S32CTG24	H-80	7165x12	J-144
4SA8MJ6	H-60	6204-040	K-29	6S32CTG32	H-80	7165x14	J-144
4SA8MJ8	H-60	6204-044	K-29	6S32DS20	H-87	7165x16	J-144
4SA8MP10	H-59	6204-048	K-29	6S32DSA20	H-88	7165x2	J-144
4SA8MP12	H-59	6204-052	K-29	6S32DSB20	H-88	7165x20	J-144
4SA8MP6	H-59	6204-056	K-29	6S32FH24	H-74	7165x24	J-144
4SA8MP8	H-59	6204-064	K-29	6S32FH32	H-74	7165x3	J-144
4SA8MR6	H-64	6204-072	K-29	6S32FHA24	H-75	7165x32	J-144
4SA8MR8	H-64	6204-080	K-29	6S32FHA32	H-75	7165x4	J-144
500023-12-8S	J-117	6204-088	K-29	6S32FHB24	H-77	7165x5	J-144
500023-12S	J-117	6204-096	K-29	6S32FHB32	H-77	7165x6	J-144
500023-16-20S	J-117	6204-104	K-29	6S32FL24	H-69	7165x8	J-144
500023-16S	J-117	6205-004	K-29	6S32FL32	H-69	7205x10	J-147
500023-20-16S	J-117	6205-006	K-29	6S32FLA24	H-71	7205x10X6	J-147
500023-8S	J-117	6206-004	K-29	6S32FLA32	H-71	7205x12	J-147
500024-12-8S	J-118	6206-006	K-29	6S32FLB24	H-73	7205x12X8	J-147
500024-8S	J-118	6207-004	K-28	6S32FLB32	H-73	7205x14	J-147
500025-12-8S	J-116	6207-005	K-28	6SA20FJ20	H-61	7205x16	J-147
500025-12S	J-116	6207-006	K-28	6SA20FJA20	H-62	7205x16X12	J-147
500025-16S	J-116	6S16FHB20	H-77	6SA20FJB20	H-63	7205x2	J-147
500025-20-16S	J-116	6S20CT20	H-78	6SA20FR20	H-65	7205x20	J-147
500025-20S	J-116	6S20CTA20	H-79	6SA20FRA20	H-66	7205x24	J-147
500025-24S	J-116	6S20CTB20	H-81	6SA20FRB20	H-67	7205x2X4	J-147
500025-8S	J-116	6S20CTD20	H-79	6SA20MP20	H-59	7205x3	J-147
500454-10S	J-99	6S20CTE20	H-82	6SA24FJ20	H-61	7205x4	J-147
500454-12S	J-99	6S20CTF20	H-80	6SA24FJ24	H-61	7205x4X4	J-147
500454-16S	J-99	6S20CTG20	H-80	6SA24FJA24	H-62	7205x4X6	J-147
500454-20S	J-99	6S20FH20	H-74	6SA24FJB24	H-63	7205x4X8	J-147
500454-4S	J-99	6S20FHA20	H-75	6SA24FR24	H-65	7205x5	J-147
500454-6S	J-99	6S20FHB20	H-77	6SA24FRA24	H-66	7205x5X4	J-147
500454-8S	J-99	6S20FHG20	H-76	6SA24FRB2	H-67	7205x6	J-147
504089-16S	J-119	6S20FL20	H-69	6SA24MP24	H-59	7205x6X2	J-147
504089-20S	J-119	6S20FLA20	H-71	6SA32FJ32	H-61	7205x6X6	J-147
504089-24S	J-119	6S20FLB20	H-73	6SA32MP32	H-59	7205x6X8	J-147
504089-32S	J-119	6S24BF24	H-83	7015x10x8	J-145	7205x8	J-147
504089-40S	J-119	6S24BFA24	H-84	7015x12x6	J-145	7205x8X12	J-147
504095-10S	J-99	6S24BFB24	H-85	7015x12x8	J-145	7205x8X4	J-147
504095-12S	J-99	6S24CT20	H-78	7015x20x16	J-145	7205x8X8	J-147
504095-16S	J-99	6S24CT24	H-78	7015x6x4	J-145	7229x10	J-145
504095-20S	J-99	6S24CTA20	H-79	7015x8x4	J-145	7229x12	J-145
504095-4S	J-99	6S24CTA24	H-79	7015x8x6	J-145	7229x16	J-145
504095-5S	J-99	6S24CTB20	H-81	7105x10	J-144	7229x2	J-145
504095-6S	J-99	6S24CTB24	H-81	7105x12	J-144	7229x4	J-145
504095-8S	J-99	6S24CTD20	H-79	7105x14	J-144	7229x5	J-145
6203-006	K-29	6S24CTD24	H-79	7105x16	J-144	7229x6	J-145
6203-008	K-29	6S24CTE20	H-82	7105x2	J-144	7229x8	J-145
6203-010	K-29	6S24CTE24	H-82	7105x20	J-144	7255x10	J-147
6203-012	K-29	6S24CTF20	H-80	7105x24	J-144	7255x12	J-147
6203-016	K-29	6S24CTF24	H-80	7105x3	J-144	7255x14	J-147
6203-020	K-29	6S24CTG20	H-80	7105x32	J-144	7255x16	J-147
6203-024	K-29	6S24CTG24	H-80	7105x4	J-144	7255x2	J-147
6203-028	K-29	6S24FH20	H-74	7105x5	J-144	7255x20	J-147
6203-032	K-29	6S24FH24	H-74	7105x6	J-144	7255x3	J-147
6203-036	K-29	6S24FHA20	H-75	7105x8	J-144	7255x4	J-147
6203-040	K-29	6S24FHA24	H-75	7129x10	J-145	7255x4x4	J-147
6203-044	K-29	6S24FHB20	H-77	7129x12	J-145	7255x5	J-147
6203-048	K-29	6S24FHB24	H-77	7129x16	J-145	7255x6	J-147
6203-052	K-29	6S24FL24	H-69	7129x20	J-145	7255x6x6	J-147
6203-056	K-29	6S24FLA24	H-71	7129x4	J-145	7255x8	J-147
6203-064	K-29	6S24FLB24	H-73	7129x6	J-145	7255x8x4	J-147
6203-072	K-29	6S32BF32	H-83	7129x8	J-145	7255x8x8	J-147
6203-080	K-29	6S32BFA32	H-84	71416-16S	J-122	73014-10S	J-123
6203-088	K-29	6S32BFB32	H-85	71416-20S	J-122	73014-12-10S	J-123
6203-096	K-29	6S32CT24	H-78	71416-24S	J-122	73014-12S	J-123
6203-104	K-29	6S32CT32	H-78	71416-32S	J-122	73014-16-12S	J-123
6204-006	K-29	6S32CTA24	H-79	71418-12-12S	J-121	73014-16-20S	J-123
6204-008	K-29	6S32CTA32	H-79	71418-16-12S	J-121	73014-16S	J-123
6204-010	K-29	6S32CTB24	H-81	71418-16-16S	J-121	73014-20-16S	J-123
6204-012	K-29	6S32CTB32	H-81	71418-20-20S	J-121	73014-20S	J-123

Part number	page	Part number	page	Part number	page	Part number	page
73014-24-20S	J-123	7405x6	J-149	75708E-W08	H-16	75761	H-22
73014-24-32S	J-123	7405x6x2	J-149	75708E-W49	H-18	7605x10	J-152
73014-24S	J-123	7405x6x6	J-149	75708E-W68	H-19	7605x12	J-152
73014-32S	J-123	7405x6x8	J-149	75708E-X08	H-19	7605x16	J-152
73014-40S	J-123	7405x8	J-149	75708E-Y38	H-17	7605x4	J-152
73014-4S	J-123	7405x8x4	J-149	75708E-Y40	H-17	7605x4x4x4	J-152
73014-5S	J-123	7405x8x8	J-149	75708E-Y48	H-18	7605x6	J-152
73014-6S	J-123	7455x10	J-149	75708E-Z08	H-16	7605x8	J-152
73014-8-6S	J-123	7455x12	J-149	75708E-Z28	H-18	7605x8x8x8	J-152
73014-8S	J-123	7455x14	J-149	75708E-Z49	H-17	7655x10	J-152
73056-16S	J-94	7455x16	J-149	75708E-Z51	H-17	7655x12	J-152
73056-2-4S	J-94	7455x4	J-149	75708E-Z59	H-17	7655x16	J-152
73056-2-6S	J-94	7455x4x4	J-149	75708E-Z66	H-19	7655x4	J-152
73056-4-6S	J-94	7455x6	J-149	75708E-Z68	H-19	7655x4x4x4	J-152
7305x10	J-146	7455x6x6	J-149	75708E-Z87	H-20	7655x6	J-152
7305x12	J-146	7455x8	J-149	75708E-Z89	H-20	7655x8	J-152
7305x14	J-146	7455x8x8	J-149	75708E-Z99	H-20	7705x10	J-150
7305x16	J-146	7505x10	J-148	75710E-390	H-18	7705x12	J-150
7305x2	J-146	7505x12	J-148	75710E-410	H-17	7705x14	J-150
7305x20	J-146	7505x14	J-148	75710E-470	H-20	7705x16	J-150
7305x24	J-146	7505x16	J-148	75710E-490	H-19	7705x3	J-150
7305x3	J-146	7505x20	J-148	75710E-758	H-16	7705x4	J-150
7305x4	J-146	7505x24	J-148	75710E-760	H-16	7705x5	J-150
7305x5	J-146	7505x4	J-148	75710E-W10	H-16	7705x6	J-150
7305x6	J-146	7505x5	J-148	75710E-W51	H-18	7705x8	J-150
7305x6x4	J-146	7505x6	J-148	75710E-W70	H-19	7716x4	J-151
7305x8	J-146	7505x8	J-148	75710E-X10	H-19	7716x6	J-151
7305x8x6	J-146	7515x10	J-150	75710E-Y40	H-17	7716x8	J-151
7306x12	J-146	7515x12	J-150	75710E-Y41	H-17	7755x10	J-150
7306x16	J-146	7515x16	J-150	75710E-Y49	H-18	7755x12	J-150
7306x4	J-146	7515x20	J-150	75710E-Z01	H-20	7755x16	J-150
7306x6	J-146	7515x4	J-150	75710E-Z10	H-16	7755x4	J-150
7306x8	J-146	7515x5	J-150	75710E-Z12	H-16	7755x4x4x4	J-150
7306x8x6	J-146	7515x6	J-150	75710E-Z30	H-18	7755x6	J-150
7315x10	J-148	7515x8	J-150	75710E-Z51	H-17	7755x8	J-150
7315x12	J-148	75701	H-20	75710E-Z53	H-17	7755x8x8x8	J-150
7315x16	J-148	75702	H-20	75710E-Z61	H-17	7805x10	J-151
7315x16x12	J-148	75704	H-20	75710E-Z70	H-19	7805x4	J-151
7315x20	J-148	75706	H-20	75710E-Z72	H-19	7805x4x4x4	J-151
7315x4	J-148	75706E-306	H-16	75710E-Z91	H-20	7805x6	J-151
7315x4x5	J-148	75708E-308	H-16	75712E-410	H-17	7805x8	J-151
7315x4x6	J-148	75710E-310	H-16	75712E-412	H-17	800108-8-316	H-91
7315x5	J-148	75712E-312	H-16	75712E-470	H-20	800108-8-CZ	H-91
7315x6	J-148	75706E-406	H-17	75712E-472	H-20	800112-12-316	H-91
7315x6x8	J-148	75706E-408	H-17	75712E-490	H-19	800112-12-CZ	H-91
7315x8	J-148	75706E-466	H-20	75712E-492	H-19	800116-16-316	H-91
7315x8x10	J-148	75706E-486	H-19	75712E-760	H-16	800116-16-CZ	H-91
7315x8x12	J-148	75706E-756	H-16	75712E-762	H-16	800120-20-316	H-91
7325x12	J-146	75706E-758	H-16	75712E-W10	H-16	800120-20-CZ	H-91
7325x16	J-146	75706E-W06	H-16	75712E-W12	H-16	800124-24-316	H-91
7325x4	J-146	75706E-W47	H-18	75712E-W51	H-18	800124-24-CZ	H-91
7325x6	J-146	75706E-W66	H-19	75712E-W53	H-18	800132-32-316	H-91
7325x8	J-146	75706E-X06	H-19	75712E-X12	H-19	800132-32-CZ	H-91
7355x10	J-148	75706E-Y36	H-17	75712E-Y41	H-17	8008	G-8
7355x12	J-148	75706E-Y38	H-17	75712E-Y50	H-18	8012	G-8
7355x16	J-148	75706E-Y47	H-18	75712E-Z01	H-20	8016	G-8
7355x4x4	J-148	75706E-Z06	H-16	75712E-Z10	H-16	8020	G-8
7355x6	J-148	75706E-Z08	H-16	75712E-Z12	H-16	8024	G-8
7355x8	J-148	75706E-Z26	H-18	75712E-Z30	H-18	8032	G-8
7405x10	J-149	75706E-Z47	H-17	75712E-Z32	H-18	8-108	H-91
7405x10x6	J-149	75706E-Z49	H-17	75712E-Z51	H-17	8112x4	J-144
7405x12	J-149	75706E-Z57	H-17	75712E-Z53	H-17	8112x5	J-144
7405x12x8	J-149	75706E-Z66	H-19	75712E-Z61	H-17	8112x6	J-144
7405x14	J-149	75706E-Z68	H-19	75712E-Z70	H-19	81430-08	K-21
7405x16	J-149	75706E-Z87	H-20	75712E-Z72	H-19	81430-10	K-21
7405x16x12	J-149	75706E-Z89	H-20	75712E-Z91	H-20	81430-12	K-21
7405x2	J-149	75706E-Z97	H-20	75712E-Z93	H-20	81430-14	K-21
7405x20	J-149	75708E-388	H-18	75729	H-21	81430-16	K-21
7405x24	J-149	75708E-408	H-17	75730	H-21	81430-18	K-21
7405x3	J-149	75708E-468	H-20	75731	H-21	81430-20	K-21
7405x4	J-149	75708E-488	H-19	75732	H-21	81430-22	K-21
7405x4x4	J-149	75708E-756	H-16	75750	H-22	81430-24	K-21
7405x5	J-149	75708E-758	H-16	75751	H-22	81430-28	K-21
7405x5x4	J-149	75708E-760	H-16	75760	H-22	81430-30	K-21

Index

Part number index

M

Part number	page	Part number	page	Part number	page	Part number	page
81430-36	K-21	900605-10S	J-127	A6908	K-4	C-40X	L-57
8165x4	J-144	900605-12S	J-127	A6910	K-4	C-5PS	H-95, H-100
8165x5	J-144	900605-14S	J-127	A6912	K-4	C-5X	L-58
8165x6	J-144	900605-16S	J-127	A6914	K-4	EC03804-250R	F-12
820008-8-316	H-92	900605-20S	J-127	A6916	K-4	EC03806-250R	F-12
820008-8-CZ	H-92	900605-24S	J-127	A6920	K-4	EC03808-250R	F-12
820012-12-316	H-92	900605-2S	J-127	A6924	K-4	EC230-40	B-24
820012-12-CZ	H-92	900605-32S	J-127	A6928	K-4	EC525-12	B-14
820016-16-316	H-92	900605-3S	J-127	A6932	K-4	EC525-16	B-14
820016-16-CZ	H-92	900605-4S	J-127	A6936	K-4	EC525-20	B-14
820020-20-316	H-92	900605-5S	J-127	A6948	K-4	EC525-24	B-14
820020-20-CZ	H-92	900605-6S	J-127	A9900	K-3	EC525-32	B-14
820024-24-316	H-92	900605-8S	J-127	A9901	K-3	EC600-12	B-16
820024-24-CZ	H-92	A1900	K-2	A9902	K-3	EC600-16	B-16
820032-32-316	H-92	A1900-20	K-2	A9903	K-3	EC600-20	B-16
820032-32-CZ	H-92	A1901	K-2	A9904	K-3	EC810-12	B-17
8508	G-8	A1901-20	K-2	A9905	K-3	EC810-16	B-17
8512	G-8	A1902	K-2	AB-140	L-64	EC810-20	B-17
8516	G-8	A1902-20	K-2	AB-9	L-59	EC810-24	B-17
8520	G-8	A1903	K-2	B-1103	H-93, H-100	EC810-32	B-17
8524	G-8	A1903-20	K-2	B-1104-1	H-93, H-100	EC850-10	B-18
8532	G-8	A1904	K-2	B-1104-2	H-93, H-100	EC850-12	B-18
8-608	H-92	A1904-20	K-2	B-1105	H-93, H-100	EC850-16	B-18
870000-12-304	H-91, H-92	A1905	K-2	B-1105-1/8	H-93, H-100	EC850-20	B-18
870000-12-CZ	H-91, H-92	A1905-20	K-2	B-1106-1	H-93, H-100	EC910-08C50	B-26
870000-16-304	H-91, H-92	A1906	K-2	B-1106-2	H-93, H-100	EC910-12C50	B-26
870000-16-CZ	H-91, H-92	A1906-20	K-2	B-1106-3	H-93, H-100	EC910-16C50	B-26
870000-20-304	H-91, H-92	A1907	K-2	B-1108-1	H-93, H-100	E-EQCR-ME002-E	L-22 - L-24
870000-20-CZ	H-91, H-92	A1907-20	K-2	B-1108-2	H-93, H-100	E-EQCR-TT006-E	L-56
870000-24-304	H-91, H-92	A1908	K-2	B-1110	H-93, H-100	EH084	D-9
870000-24-CZ	H-91, H-92	A1908-20	K-2	B-1112	H-93, H-100	EH22504	F-24
870000-32-304	H-91, H-92	A1912	K-2	B-1116	H-93, H-100	EH22505	F-24
870000-32-CZ	H-91, H-92	A1913	K-2	B-1116Z	H-93, H-100	EH22506	F-24
870000-8-304	H-91, H-92	A1916	K-2	B-1120Z	H-93, H-100	EH22508	F-24
870000-8-CZ	H-91, H-92	A1917	K-2	B-1303	H-93, H-100	EH22510	F-24
8-F00	H-92	A1919	K-2	B-1303-4	H-93, H-100	EH22512	F-24
900598-10S	J-58	A2103	L-68	B-1304	H-93, H-100	EH22514	F-24
900598-1-10S	J-58	A2900	K-2	B-1305	H-93, H-100	EH22516	F-24
900598-1-12S	J-58	A2901	K-2	B-1306	H-93, H-100	EH22605	F-25
900598-1-14S	J-58	A2902	K-2	B-1308	H-93, H-100	EH22606	F-25
900598-1-16S	J-58	A2904	K-2	B-1310	H-93, H-100	EH22608	F-25
900598-1-20S	J-58	A2905	K-2	B-1312	H-93, H-100	EH22610	F-25
900598-1-24S	J-58	A2906	K-2	B-1316	H-93, H-100	EH22612	F-25
900598-1-2S	J-58	A2907	K-2	B-1316Z	H-93, H-100	EH22614	F-25
900598-1-32S	J-58	A2908	K-2	B-1320Z	H-93, H-100	EH22616	F-25
900598-1-3S	J-58	A2909	K-2	B-2104-1	H-100	EH22617	F-25
900598-1-4S	J-58	A2910	K-2	B-2104-2	H-100	EH22618	F-25
900598-1-5S	J-58	A2911	K-2	B-2105	H-100	EH22620	F-25
900598-1-6S	J-58	A2912	K-2	B-6LFC	H-95	EH22622	F-25
900598-1-8S	J-58	A2913	K-2	BF-40	L-63	EH22624	F-25
900598-16S	J-58	A2917	K-2	BF-41	L-63	EH22626	F-25
900598-16S	J-58	A2919	K-2	BL-456	L-60	EH22628	F-25
900598-18S	J-58	A4900	K-3	C-1104-1	H-100	EH22630	F-25
900598-20S	J-58	A4901	K-3	C-1104-2	H-100	EH22632	F-25
900598-24S	J-58	A4902	K-3	C-1105	H-100	EH22634	F-25
900598-2S	J-58	A4903	K-3	C-1106-1	H-100	EH22636	F-25
900598-32S	J-58	A4904	K-3	C-1106-2	H-100	EH22638	F-25
900598-3S	J-58	A4905	K-3	C-1106-3	H-100	EH22640	F-25
900598-4S	J-58	A4906	K-3	C-1108-1	H-100	EH22642	F-25
900598-5S	J-58	A4907	K-3	C-1108-2	H-100	EH22644	F-25
900598-6S	J-58	A4908	K-3	C-1110	H-100	EH22646	F-25
900598-8S	J-58	A4910	K-3	C-1112	H-100	EH22648	F-25
900599-10S	J-95	A4926	K-25	C-1116	H-100	EH22650	F-25
900599-12S	J-95	A4927	K-25	C-1116Z	H-100	EH22652	F-25
900599-14S	J-95	A4928	K-25	C-1120Z	H-100	EH22654	F-25
900599-16S	J-95	A4929	K-25	C-1304	H-100	EH22656	F-25
900599-20S	J-95	A4930	K-25	C-1305	H-100	EH22658	F-25
900599-24S	J-95	A5953	K-4	C-1306	H-100	EH22660	F-25
900599-32S	J-95	A5962	K-4	C-1308	H-100	EH22664	F-25
900599-3S	J-95	A5969	K-4	C-1310	H-100	EH22666	F-25
900599-4S	J-95	A5975	K-4	C-1312	H-100	EH22668	F-25
900599-5S	J-95	A5984	K-4	C-1316	H-100	EH22672	F-25
900599-6S	J-95	A5987	K-4	C-1316Z	H-100	EH22680	F-25
900599-8S	J-95	A6900W	K-4	C-1320Z	H-100	EH22688	F-25

Part number	page	Part number	page	Part number	page	Part number	page
EH22696	F-25	EJ3534-05-1010S	I-42	ET313DC-4Z	L-6	ET5040DC-R5-08	L-18
EH22704	F-26	EJ3534-06-1212S	I-42	ET313DC-5Z	L-6	ET5040DC-R5-10	L-18
EH22706	F-26	EJ3534-07-1616S	I-42	ET313DC-6Z	L-6	ET5040DC-R5-12	L-18
EH22708	F-26	EJ3543-1010S	I-37	ET313DC-8Z	L-6	ET5040DC-R5-16	L-18
EH22710	F-26	EJ3809-01-0606S	I-57	ET4000AR-001	L-22	ET5040DC-R5-20	L-18
EH22712	F-26	EJ3809-02-0806S	I-57	ET4000AR-002	L-22	ET5040DC-R5-24	L-18
EH22714	F-26	EJ3809-03-0608S	I-57	ET4000TP-0001	L-22	ET5040DC-R5-32	L-18
EH22716	F-26	EJ3809-04-0808S	I-57	ET4000TP-0002	L-22	ET5040PBL-M1030	L-18
EH22717	F-26	EJ3809-05-1008S	I-57	ET4001	L-15	ET5040PBL-M1060	L-18
EH22718	F-26	EJ3809-06-0810S	I-57	ET4001-004	L-16	ET5040PBL-M1110	L-18
EH22720	F-26	EJ3809-07-1010S	I-57	ET4001-004CSA	L-16	ET5040PBL-M1160	L-18
EH22721	F-26	EJ3809-08-1012S	I-57	ET4001-015	L-16	ET5040PBL-M1210	L-18
EH22722	F-26	EJ3809-09-1212S	I-57	ET4001-015CSA	L-16	ET5040PBL-M1260	L-18
EH22724	F-26	EJ3809-10-1210S	I-57	ET4001C-0015	L-22	ET5040PBL-M1310	L-18
EH22726	F-26	EJ3809-11-0506S	I-57	ET4001C-0017	L-16, L-19, L-22	ET5040PBL-M740	L-18
EH22728	F-26	EJ5096-080808	I-53	ET4001P-002	L-16, L-28	ET5040PBL-M780	L-18
EH22730	F-26	EJ5096-101010	I-53	ET4001P-002CSA	L-16	ET5040PBL-M840	L-18
EH22732	F-26	EJ5096-101012	I-53	ET4020TP-0002	L-4	ET5040PBL-M860	L-18
EH22734	F-26	EJ5096-121212	I-53	ET4020TP-0003	L-4	ET5040PBL-M900	L-18
EH22736	F-26	EJ5096-121216	I-53	ET420-007	L-11	ET5040PBL-M960	L-18
EH22738	F-26	EJ5305-1212S	I-28	ET420-007CSA	L-11	ET5040PBL-MXXX	L-19
EH22740	F-26	EJ5305-1616S	I-28	ET420-008	L-11	ET5050	L-17
EH22742	F-26	EJ5305-2020S	I-28	ET420-008CSA	L-11	ET5050-001-230KT	L-18
EH22744	F-26	EJ5305-2424S	I-28	ET425DC-10Z	L-10	ET5050-001-380KT	L-18
EH22746	F-26	EJ5306-1212S	I-29	ET425DC-12Z	L-10	ET5050-001-400KT	L-18
EH22748	F-26	EJ5306-1616S	I-29	ET425DC-16Z	L-10	ET5050-001-420KT	L-18
EH22750	F-26	EJ5306-2020S	I-29	ET425DC-20Z	L-10	ET5050-001-440KT	L-18
EH22752	F-26	EJ5306-2424S	I-29	ET425DC-4S10	L-10	ET5050-001-460KT	L-18
EH22754	F-26	EJ5359-1212S	I-29	ET425DC-4S12	L-10	ET5050-001-480KT	L-18
EH22756	F-26	EJ5359-1616S	I-29	ET425DC-4S16	L-10	ET5050C-0009	L-19
EH22758	F-26	EJ5359-2020S	I-29	ET425DC-4S20	L-10	ET525DC-10Z	L-15
EH22760	F-26	EJ5360-1212S	I-29	ET425DC-4S6	L-10	ET525DC-12Z	L-15
EH22764	F-26	EJ5360-1616S	I-29	ET425DC-4S8	L-10	ET525DC-16Z	L-15
EH22772	F-26	EJ5360-2020S	I-29	ET425DC-4Z	L-10	ET525DC-20Z	L-15
EH22780	F-26	EJ5361-1212S	I-28	ET425DC-5Z	L-10	ET525DC-24Z	L-15
EH920	D-5	EJ5361-1616S	I-28	ET425DC-6Z	L-10	ET525DC-32Z	L-15
EHA500	D-2	EJ5361-2020S	I-28	ET425DC-8Z	L-10	ET525DC-4S10	L-15
EHK006	D-6	EJ5361-2424S	I-28	ET5040C-0001	L-19	ET525DC-4S12	L-15
EHK007	D-6	EJ5362-1212S	I-28	ET5040C-0004	L-19	ET525DC-4S16	L-15
E-HOAI-CC001-E	L-45	EJ5362-1616S	I-28	ET5040C-0006	L-19	ET525DC-4S20	L-15
E-HOAI-CC002-E	L-45	EJ5362-2020S	I-28	ET5040C-0007	L-19	ET525DC-4S6	L-15
E-HOAI-CC003-E	L-45	EJ5362-2424S	I-28	ET5040C-0014	L-19	ET525DC-4S8	L-15
E-HOAI-CC004-E	L-45	ET1000	L-6	ET5040C-0016	L-19	ET525DC-4Z	L-15
EHP009	D-7	ET1000-001	L-7	ET5040C-0019	L-19	ET525DC-5Z	L-15
EHP150	D-7	ET1000-020	L-7	ET5040C-0020	L-19	ET525DC-6S20	L-15
EHW028	D-10	ET1000-021	L-7	ET5040C-0023	L-19	ET525DC-6Z	L-15
EHW029	D-10	ET1000AR-001	L-22	ET5040DC-M070S	L-17	ET525DC-8Z	L-15
EHW150	D-10	ET1000C-0001	L-22	ET5040DC-M090S	L-17	ET575DC-4S24	L-15
EJ3111-1016S	I-33	ET1000C-0006	L-22	ET5040DC-M120S	L-17	ET575DC-4S32	L-15
EJ3111-1216S	I-33	ET1000DC-12Z	L-6	ET5040DC-M150S	L-17	ET575DC-6S24	L-15
EJ3158-060808S	I-47	ET1000DC-16Z	L-6	ET5040DC-M180S	L-17	ET575DC-6S32	L-15
EJ3158-101212S	I-47	ET1000DC-4S12	L-6	ET5040DC-M210S	L-17	ET9100	L-32
EJ3158-121616S	I-47	ET1000DC-4S16	L-6	ET5040DC-M240S	L-17	ET9100-07-110	L-32
EJ3297-01-0808S	I-39	ET1000PK-001	L-5, L-7	ET5040DC-M280S	L-17	ET9100-07-110CSA	L-32
EJ3298-01-0808S	I-38	ET1000PK-002	L-5, L-7	ET5040DC-M320S	L-17, L-19	ET9100-07-22050	L-32
EJ3299-01-0808S	I-35	ET1000PK-003	L-5, L-7	ET5040DC-M355S	L-17	ET9100-07-22060	L-32
EJ3302-01-0608S	I-37	ET1000PK-004	L-5, L-7	ET5040DC-M370S	L-17	ET9100-07-AS	L-32
EJ3302-02-0808S	I-37	ET1000TP-1001	L-6	ET5040DC-M420S	L-17	ET9100-07-MS	L-32
EJ3321-1008S	I-48	ET1000TP-1002	L-6	ET5040DC-M450S	L-17	ET9100-07-SC	L-32
EJ3321-1012S	I-48	ET1187	L-4	ET5040DC-M465S	L-17	ET9100-07-SL	L-32
EJ3410-0808S	I-37	ET1187-001	L-5	ET5040DC-M505S	L-17	ET9100-07-SM	L-32
EJ3421-1012S	I-48	ET1187-002	L-5	ET5040DC-M520S	L-17	ET9100C-07-AS	L-34
EJ3422-1016S	I-48	ET1187-003	L-5	ET5040DC-M550S	L-17	ET9100C-07-MS	L-35
EJ3533-01-0404S	I-44	ET1187-004	L-5	ET5040DC-M570S	L-17	ET9100C-07-SC	L-35
EJ3533-02-0606S	I-44	ET1187C-0008PR	L-5	ET5040DC-M590S	L-17	ET9100C-07-SL	L-35
EJ3533-03-0608S	I-44	ET1187C-0008WR	L-5	ET5040DC-M620S	L-17	ET9100C-07-SM	L-34
EJ3533-04-0808S	I-44	ET1187C-0009PR	L-5	ET5040DC-M690S	L-17	ET9200	L-33
EJ3533-05-1010S	I-44	ET1187C-0009WR	L-5	ET5040DC-M720S	L-17	ET9200-10-12V	L-33
EJ3533-06-1212S	I-44	ET1187C-0017	L-5	ET5040DC-M775S	L-17	ET9200-10-1-SM	L-34
EJ3533-07-1616S	I-44	ET1187C-0019	L-5	ET5040DC-M790S	L-17	ET9200-10-220	L-33
EJ3534-01-0404S	I-42	ET313DC-10Z	L-6	ET5040DC-MXXX	L-19	ET9200-10-220-3CSA	L-33
EJ3534-02-0606S	I-42	ET313DC-4S10	L-6	ET5040DC-R5-04	L-18	ET9200-10-22050	L-33
EJ3534-03-0608S	I-42	ET313DC-4S6	L-6	ET5040DC-R5-05	L-18	ET9200-10-220CSA	L-33
EJ3534-04-0808S	I-42	ET313DC-4S8	L-6	ET5040DC-R5-06	L-18	ET9200-10-24V	L-33

Part number index

M

Part number	page	Part number	page	Part number	page	Part number	page
ET9200-10-440-3	L-33	ET9500C-24-MS	L-35	FF1010-0406S	J-58	FF14174	I-59
ET9200C-10-1-MS	L-35	ET9500C-24-SL	L-35	FF1010-0408S	J-58	FF14401	I-59
ET9200C-10-1-SL	L-35	ET9500C-24-SM	L-34	FF1010-0604S	J-58	FF14402	I-59
ET9200C-10-AS	L-33, L-34	ET9500C-26-MS	L-35	FF1010-0806S	J-58	FF1455-J-XX	L-46
ET9200C-10-D	L-33, L-34	ET9500C-26-SL	L-35	FF1010-1008S	J-58	FF1455-NT-XX	L-47
ET9200C-10-MS	L-33, L-35	ET9500C-26-SM	L-34	FF1010-1206S	J-58	FF14783	K-22
ET9200C-10-SC	L-33, L-35	F3161-08-0810S	I-44	FF1010-1208S	J-58	FF14784	K-22
ET9200C-10-SL	L-33, L-35	FC1102-0808S	J-122	FF1010-1210S	J-58	FF14787	K-22
ET9200C-10-SM	L-33, L-34	FC1102-1208S	J-122	FF1010-1216S	J-58	FF14788	K-22
ET9300	L-33	FC1102-1212S	J-122	FF1010-1412S	J-58	FF14794	K-22
ET9300-14-220	L-33	FC1102-1612S	J-122	FF1010-1608S	J-58	FF14796	K-22
ET9300-14-220-3	L-33	FC1102-1616S	J-122	FF1010-1610S	J-58	FF14798	K-22
ET9300-14-220-3CSA	L-33	FC1102-2012S	J-122	FF1010-1612S	J-58	FF14799	K-22
ET9300-14-22050	L-33	FC1102-2016S	J-122	FF1010-2012S	J-58	FF14800	K-22
ET9300-14-440-3	L-33	FC1102-2020S	J-122	FF1010-2016S	J-58	FF14801	K-22
ET9300C-14-AS	L-33, L-34	FC1102-2416S	J-122	FF1010-2412S	J-58	FF14802	K-22
ET9300C-14-D	L-33, L-34	FC1102-2420S	J-122	FF1010-2420S	J-58	FF1555-XXXXBP	L-56
ET9300C-14-MS	L-33, L-35	FC1102-2424S	J-122	FF1066-0604S	J-97	FF16087-01	J-112
ET9300C-14-SC	L-33	FC1102-3224S	J-122	FF1066-0804S	J-97	FF1796-0402S	J-59
ET9300C-14-SL	L-33, L-35	FC1102-3232S	J-122	FF1066-0806S	J-97	FF1796-0604S	J-59
ET9300C-14-SM	L-33, L-34	FC1132-1616	J-122	FF1066-1204S	J-97	FF1796-0806S	J-59
ET9500C-06-AS	L-34	FC1229-0404S	J-41	FF1066-1206S	J-97	FF1796-0808S	J-59
ET9500C-06-MS	L-35	FC1229-0606S	J-41	FF1066-1208S	J-97	FF1796-1008S	J-59
ET9500C-07-AS	L-34	FC1229-0808S	J-41	FF1066-1612S	J-97	FF1796-1212S	J-59
ET9500C-07-MS	L-35	FC1229-1212S	J-41	FF1066-2012S	J-97	FF1796-1616S	J-59
ET9500C-07-SC	L-35	FC1229-1616S	J-41	FF1159-0406S	J-94	FF1796-2020S	J-59
ET9500C-07-SL	L-35	FC1229-2020S	J-41	FF1159-2020S	J-94	FF1796-2424S	J-59
ET9500C-07-SM	L-34	FC1229-2424S	J-41	FF1162-0406S	J-70	FF1796-3232S	J-59
ET9500C-08-AS	L-34	FC1851-04S	J-40	FF1162-1212S	J-70	FF1851T0404S	J-42
ET9500C-08-MS	L-35	FC1851-06S	J-40	FF1162-1616S	J-70	FF1851T0606S	J-42
ET9500C-08-SC	L-35	FC1851-08S	J-40	FF1162-2020S	J-70	FF1851T0608S	J-42
ET9500C-08-SL	L-35	FC1851-10S	J-40	FF1167-1212S	J-60	FF1851T0808S	J-42
ET9500C-08-SM	L-34	FC1851-12S	J-40	FF12139	L-61	FF1851T1010S	J-42
ET9500C-10-1-AS	L-34	FC1851-16S	J-40	FF12262-0606	I-59	FF1851T1212S	J-42
ET9500C-10-1-MS	L-35	FC1851-20S	J-40	FF12262-0608	I-59	FF1851T1216S	J-42
ET9500C-10-1-SC	L-35	FC1851-24S	J-40	FF12262-0808	I-59	FF1851T1612S	J-42
ET9500C-10-1-SL	L-35	FC2119-12-449	J-111	FF12262-0810	I-59	FF1851T1616S	J-42
ET9500C-10-1-SM	L-34	FC2119-16-449	J-111	FF12262-1010	I-59	FF1851T1620S	J-42
ET9500C-10-2-MS	L-35	FC2119-20-449	J-111	FF12262-1012	I-59	FF1851T2020S	J-42
ET9500C-10-2-SL	L-35	FC2119-24-449	J-111	FF12262-1016	I-59	FF1851T2424S	J-42
ET9500C-10-2-SM	L-34	FC2119-32-449	J-111	FF12262-1212	I-59	FF1852T0403S	J-44
ET9500C-10-3-SL	L-35	FC2119-40-449	J-111	FF12262-1216	I-59	FF1852T0404S	J-44
ET9500C-10-AS	L-34	FC2325-0404S	J-41	FF12262-1616	I-59	FF1852T0405S	J-44
ET9500C-10-MS	L-35	FC2325-0606S	J-41	FF1315-0404S	J-120	FF1852T0406S	J-44
ET9500C-10-SC	L-35	FC2325-0808S	J-41	FF1315-0604S	J-120	FF1852T0408S	J-44
ET9500C-10-SL	L-35	FC2325-1010S	J-41	FF1315-0606S	J-120	FF1852T0603S	J-44
ET9500C-10-SM	L-34	FC2325-1212S	J-41	FF1315-0806S	J-120	FF1852T0604S	J-44
ET9500C-12-1-MS	L-35	FC2325-1616S	J-41	FF1315-0808S	J-120	FF1852T0605S	J-44
ET9500C-12-1-SL	L-35	FC2325-2020S	J-41	FF1315-1008S	J-120	FF1852T0606S	J-44
ET9500C-12-1-SM	L-34	FC2325-2424S	J-41	FF1315-1010S	J-120	FF1852T0608S	J-44
ET9500C-12-AS	L-34	FC2326-04S	J-43	FF1315-1212S	J-120	FF1852T0610S	J-44
ET9500C-12-MS	L-35	FC2326-06S	J-43	FF1315-1616S	J-120	FF1852T0612S	J-44
ET9500C-12-SC	L-35	FC2326-08S	J-43	FF13267	K-24	FF1852T0616S	J-44
ET9500C-12-SL	L-35	FC2326-10S	J-43	FF13268	K-24	FF1852T0806S	J-44
ET9500C-12-SM	L-34	FC2326-12S	J-43	FF13269	K-24	FF1852T0808S	J-44
ET9500C-14-AS	L-34	FC2326-16S	J-43	FF13270	K-24	FF1852T0810S	J-44
ET9500C-14-MS	L-35	FC2326-20S	J-43	FF13271	K-24	FF1852T0812S	J-44
ET9500C-14-SC	L-35	FC2326-24S	J-43	FF13272	K-24	FF1852T0814S	J-44
ET9500C-14-SL	L-35	FC2875-03S	J-126	FF13273	K-24	FF1852T0816S	J-44
ET9500C-14-SM	L-34	FC2875-04S	J-126	FF1353-0404S	J-129	FF1852T1008S	J-44
ET9500C-16-MS	L-35	FC2875-05S	J-126	FF1354-0404S	J-129	FF1852T1010S	J-44
ET9500C-16-SL	L-35	FC2875-06S	J-126	FF13570	K-24	FF1852T1206S	J-44
ET9500C-16-SM	L-34	FC2875-08S	J-126	FF13571	K-24	FF1852T1208S	J-44
ET9500C-18-MS	L-35	FC2875-10S	J-126	FF13727-1006	I-60	FF1852T1210S	J-44
ET9500C-18-SL	L-35	FC2875-12S	J-126	FF13727-1208	I-60	FF1852T1212S	J-44
ET9500C-18-SM	L-34	FC2875-16S	J-126	FF13727-1610	I-60	FF1852T1214S	J-44
ET9500C-20-1-SL	L-35	FC2875-20S	J-126	FF13727-1812	I-60	FF1852T1216S	J-44
ET9500C-20-MS	L-35	FC2875-24S	J-126	FF13819	I-59	FF1852T1608S	J-44
ET9500C-20-SL	L-35	FC701	D-10	FF13820	I-59	FF1852T1610S	J-44
ET9500C-20-SM	L-34	FC702	D-10	FF13821	I-59	FF1852T1612S	J-44
ET9500C-21-SL	L-35	FC800-12	E-5	FF13822	I-59	FF1852T1614S	J-44
ET9500C-22-MS	L-35	FC800-16	E-5	FF14171	I-59	FF1852T1616S	J-44
ET9500C-22-SL	L-35	FC800-20	E-5	FF14172	I-59	FF1852T1620S	J-44
ET9500C-22-SM	L-34	FC800-24	E-5	FF14173	I-59	FF1852T2016S	J-44

Part number	page	Part number	page	Part number	page	Part number	page
FF1852T2020S	J-44	FF1898T1010S	J-54	FF2033T1212S	J-55	FF2138-03S	J-59
FF1852T2420S	J-44	FF1898T1212S	J-54	FF2033T1616S	J-55	FF2138-04S	J-59
FF1854T0404S	J-45	FF1922T0606S	J-42	FF2035T0404S	J-54	FF2138-05S	J-59
FF1854T0606S	J-45	FF1922T1010S	J-42	FF2035T0604S	J-54	FF2138-06S	J-59
FF1854T0808S	J-45	FF1922T1212S	J-42	FF2035T0606S	J-54	FF2138-08S	J-59
FF1854T1010S	J-45	FF1922T1616S	J-42	FF2035T0808S	J-54	FF2138-10S	J-59
FF1854T1212S	J-45	FF1980-0404	J-129	FF2035T1010S	J-54	FF2138-12S	J-59
FF1854T1616S	J-45	FF1980-0606	J-129	FF2035T1212S	J-54	FF2138-14S	J-59
FF1854T2020S	J-45	FF1980-0808	J-129	FF2035T1616S	J-54	FF2138-16S	J-59
FF1854T2424S	J-45	FF1981-0404	J-129	FF2035T2020S	J-54	FF2138-20S	J-59
FF1856T0606S	J-42	FF1981-0606	J-129	FF2068T0404S	J-47	FF2144H4-0404S	J-53
FF1856T0808S	J-42	FF1981-0808	J-129	FF2068T0406S	J-47	FF2144H4-0606S	J-53
FF1856T1010S	J-42	FF1994H4-0606S	J-53	FF2068T0408S	J-47	FF2144H4-0808S	J-53
FF1856T1212S	J-42	FF1994H4-0808S	J-53	FF2068T0604S	J-47	FF2144T0404S	J-53
FF1856T1616S	J-42	FF1994H4-1010S	J-53	FF2068T0606S	J-47	FF2144T0606S	J-53
FF1856T1820S	J-42	FF1994H4-1212S	J-53	FF2068T0608S	J-47	FF2144T0808S	J-53
FF1856T2424S	J-42	FF1994H4-1616S	J-53	FF2068T0806S	J-47	FF2144T1212S	J-53
FF1857T0404S	J-55	FF2000T0404S	J-52	FF2068T0808S	J-47	FF2144T1616S	J-53
FF1857T0606S	J-55	FF2000T0604S	J-52	FF2068T0810S	J-47	FF2174T0404S	J-55
FF1857T0808S	J-55	FF2000T0606S	J-52	FF2068T0816S	J-47	FF2174T0606S	J-55
FF1857T1010S	J-55	FF2000T0806S	J-52	FF2068T1008S	J-47	FF2174T0808S	J-55
FF1857T1212S	J-55	FF2000T0808S	J-52	FF2068T1010S	J-47	FF2174T1212S	J-55
FF1857T1616S	J-55	FF2000T1008S	J-52	FF2068T1012S	J-47	FF2174T1616S	J-55
FF1857T2020S	J-55	FF2000T1010S	J-52	FF2068T1012S	J-47	FF2174T2020S	J-55
FF1858T0606S	J-43	FF2000T1208S	J-52	FF2068T1210S	J-47	FF2209T0404S	J-51
FF1858T1616S	J-43	FF2000T1210S	J-52	FF2068T1212S	J-47	FF2209T0412S	J-51
FF1861T0404S	J-48	FF2000T1212S	J-52	FF2068T1216S	J-47	FF2209T0606S	J-51
FF1861T0606S	J-48	FF2000T1612S	J-52	FF2068T1612S	J-47	FF2209T0612S	J-51
FF1861T0806S	J-48	FF2000T1616S	J-52	FF2068T1616S	J-47	FF2209T0808S	J-51
FF1861T0808S	J-48	FF2000T2020S	J-52	FF2068T1620S	J-47	FF2209T0812S	J-51
FF1861T1010S	J-48	FF2000T2424S	J-52	FF2068T2020S	J-47	FF2209T1010S	J-51
FF1861T1212S	J-48	FF2001T0404S	J-50	FF2068T2424S	J-47	FF2209T1212S	J-51
FF1861T1216S	J-48	FF2001T0604S	J-50	FF2093T0402S	J-49	FF2209T1216S	J-51
FF1861T1616S	J-48	FF2001T0606S	J-50	FF2093T0604S	J-49	FF2209T2016S	J-51
FF1865T0404S	J-48	FF2001T0806S	J-50	FF2093T0806S	J-49	FF2209T2020S	J-51
FF1865T0406S	J-48	FF2001T0808S	J-50	FF2093T1212S	J-49	FF2211T0808S	J-45
FF1865T0606S	J-48	FF2001T1212S	J-50	FF2098T0404S	J-53	FF2211T1212S	J-45
FF1865T0808S	J-48	FF2001T1616S	J-50	FF2098T0606S	J-53	FF2211T1616S	J-45
FF1865T1212S	J-48	FF2030H4-0606S	J-54	FF2098T0808S	J-53	FF2227T0404S	J-47
FF1868T0404S	J-46	FF2030H4-0808S	J-54	FF2098T1010S	J-53	FF2227T0606S	J-47
FF1868T0405S	J-46	FF2030H4-1212S	J-54	FF2098T1212S	J-53	FF2227T0808S	J-47
FF1868T0406S	J-46	FF2030H4-1616S	J-54	FF2098T1616S	J-53	FF2227T1010S	J-47
FF1868T0408S	J-46	FF2031T0402S	J-49	FF2098T2020S	J-53	FF2227T1212S	J-47
FF1868T0604S	J-46	FF2031T0406S	J-49	FF2098T2424S	J-53	FF2227T1616S	J-47
FF1868T0605S	J-46	FF2031T0408S	J-49	FF2114T0404S	J-55	FF2227T2020S	J-47
FF1868T0606S	J-46	FF2031T0602S	J-49	FF2114T0606S	J-55	FF2281T0406S	J-52
FF1868T0608S	J-46	FF2031T0604S	J-49	FF2114T0808S	J-55	FF2281T0408S	J-52
FF1868T0610S	J-46	FF2031T0606S	J-49	FF2114T1010S	J-55	FF2281T0410S	J-52
FF1868T0612S	J-46	FF2031T0608S	J-49	FF2114T1212S	J-55	FF2281T0412S	J-52
FF1868T0806S	J-46	FF2031T0804S	J-49	FF2114T1616S	J-55	FF2281T0608S	J-52
FF1868T0808S	J-46	FF2031T0806S	J-49	FF2114T2020S	J-55	FF2281T0610S	J-52
FF1868T0810S	J-46	FF2031T0808S	J-49	FF2114T2424S	J-55	FF2281T0612S	J-52
FF1868T0812S	J-46	FF2031T0808S	J-49	FF2115T0606S	J-43	FF2281T1012S	J-52
FF1868T1008S	J-46	FF2031T0812S	J-49	FF2130T0606S	J-45	FF2281T1012S	J-52
FF1868T1010S	J-46	FF2031T1008S	J-49	FF2130T0808S	J-45	FF2281T1216S	J-52
FF1868T1012S	J-46	FF2031T1012S	J-49	FF2130T1212S	J-45	FF2281T1220S	J-52
FF1868T1208S	J-46	FF2031T1208S	J-49	FF2130T1616S	J-45	FF2281T1224S	J-52
FF1868T1210S	J-46	FF2031T1212S	J-49	FF2130T2020S	J-45	FF2281T1620S	J-52
FF1868T1212S	J-46	FF2031T1216S	J-49	FF2133T0606S	J-53	FF2281T1624S	J-52
FF1868T1214S	J-46	FF2031T1612S	J-49	FF2133T0808S	J-53	FF2281T1810S	J-52
FF1868T1216S	J-46	FF2031T1616S	J-49	FF2133T1010S	J-53	FF2281T1812S	J-52
FF1868T1612S	J-46	FF2031T1620S	J-49	FF2133T1212S	J-53	FF2281T1816S	J-52
FF1868T1614S	J-46	FF2031T2016S	J-49	FF2133T1616S	J-53	FF2313T0808S	J-51
FF1868T1616S	J-46	FF2031T2020S	J-49	FF2137-02S	J-59	FF2485T0818S	J-134
FF1868T1620S	J-46	FF2031T2424S	J-49	FF2137-03S	J-59	FF2485T0822S	J-134
FF1868T2012S	J-46	FF2032T0402S	J-50	FF2137-04S	J-59	FF2522T1624S	J-115
FF1868T2016S	J-46	FF2032T0604S	J-50	FF2137-05S	J-59	FF2591-0404S	J-60
FF1868T2020S	J-46	FF2032T0806S	J-50	FF2137-06S	J-59	FF2593-0404S	J-138
FF1868T2020S	J-46	FF2032T1008S	J-50	FF2137-08S	J-59	FF2593-0606S	J-138
FF1868T2420S	J-46	FF2032T1212S	J-50	FF2137-08S	J-59	FF2593-0808S	J-138
FF1868T2424S	J-46	FF2032T1616S	J-50	FF2137-10S	J-59	FF2593-1212S	J-138
FF1898T0404S	J-54	FF2032T2020S	J-50	FF2137-12S	J-59	FF2742T0612S	J-134
FF1898T0606S	J-54	FF2032T2424S	J-50	FF2137-14S	J-59	FF2742T0614S	J-134
FF1898T0608S	J-54	FF2033T0606S	J-55	FF2137-16S	J-59	FF2742T0818S	J-134
FF1898T0808S	J-54	FF2033T0808S	J-55	FF2137-20S	J-59	FF2742T0822S	J-134

Index

Part number index

M

Part number	page	Part number	page	Part number	page	Part number	page
FF2742T1022S	J-134	FF5163-1212S	J-99	FF90103-08S	J-40	FF90521-14	K-27
FF2742T1222S	J-134	FF5163-1616S	J-99	FF90103-10S	J-40	FF90521-16	K-27
FF2744T0818S	J-134	FF5163-2020S	J-99	FF90103-12S	J-40	FF90521-18	K-27
FF3910-0606S	J-106	FF5163-2424S	J-99	FF90103-16S	J-40	FF90521-20	K-27
FF3910-0808S	J-106	FF5164-0808S	J-100	FF90103-20S	J-40	FF90521-22	K-27
FF3910-1212S	J-106	FF5164-1212S	J-100	FF90103-24S	J-40	FF90521-24	K-27
FF4174-0606S	J-103	FF5164-1616S	J-100	FF9016-XXX	J-111	FF90521-26	K-27
FF4174-0808S	J-103	FF5164-2020S	J-100	FF90178-11	I-31	FF90521-4	K-27
FF4174-1010S	J-103	FF5238-2020S	J-117	FF90178-13	I-31	FF90521-6	K-27
FF4175-0202S	J-72	FF5238-2424S	J-117	FF90178-15	I-31	FF90521-8	K-27
FF4175-0404S	J-72	FF5238-3232S	J-117	FF90178-17	I-31	FF90522-10	K-27
FF4175-0606S	J-72	FF5239-3232S	J-116	FF90192-01	I-61	FF90522-12	K-27
FF4175-0808S	J-72	FF5321-1616S	J-119	FF90192-02	I-61	FF90522-14	K-27
FF4175-1212S	J-72	FF5321-2020S	J-119	FF90193-01	I-61	FF90522-16	K-27
FF4175-1616S	J-72	FF5321-2424S	J-119	FF90193-02	I-61	FF90522-18	K-27
FF4177-02S	J-64	FF5321-3232S	J-119	FF90308	K-22	FF90522-20	K-27
FF4177-04S	J-64	FF5539-1212S	J-117	FF90308-01	K-22, L-37	FF90522-4	K-27
FF4177-06S	J-64	FF5539-1612S	J-117	FF90308-02	K-22, L-37	FF90522-6	K-27
FF4177-08S	J-64	FF5539-1616S	J-117	FF90308-04	K-22, L-37	FF90522-8	K-27
FF4177-12S	J-64	FF5539-2016S	J-117	FF90308-05	K-22, L-37	FF90523-10	K-27
FF4177-16S	J-64	FF5539-2020S	J-117	FF90311-127	K-28	FF90523-12	K-27
FF4179-0404S	J-137	FF5539-2416S	J-117	FF90311-137	K-28	FF90523-14	K-27
FF4179-0504S	J-137	FF5539-2420S	J-117	FF90311-150	K-28	FF90523-16	K-27
FF4179-0604S	J-137	FF5539-2424S	J-117	FF90311-160	K-28	FF90523-18	K-27
FF4179-0606S	J-137	FF5540-1212S	J-119	FF90311-171	K-28	FF90523-20	K-27
FF4179-0806S	J-137	FF5540-1612S	J-119	FF90311-174	K-28	FF90523-4	K-27
FF4179-0808S	J-137	FF5540-1616S	J-119	FF90311-190	K-28	FF90523-6	K-27
FF4179-1008S	J-137	FF5540-2020S	J-119	FF90311-205	K-28	FF90523-8	K-27
FF4179-1212S	J-137	FF5540-2416S	J-119	FF90311-222	K-28	FF90524-10	K-27
FF4179-1616S	J-137	FF5540-2420S	J-119	FF90311-239	K-28	FF90524-12	K-27
FF4179-2020S	J-137	FF5540-2424S	J-119	FF90311-254	K-28	FF90524-14	K-27
FF4180-0406S	J-135	FF5541-1212S	J-116	FF90311-266	K-28	FF90524-16	K-27
FF4180-0508S	J-135	FF5541-1616S	J-116	FF90311-280	K-28	FF90524-18	K-27
FF4180-0610S	J-135	FF5541-2020S	J-116	FF90311-300	K-28	FF90524-20	K-27
FF4180-0812S	J-135	FF5541-2424S	J-116	FF90311-320	K-28	FF90524-4	K-27
FF4180-1014S	J-135	FF593-08	J-110	FF90311-334	K-28	FF90524-6	K-27
FF4180-1220S	J-135	FF593-12	J-110	FF90311-357	K-28	FF90524-8	K-27
FF4180-1625S	J-135	FF593-16	J-110	FF90311-381	K-28	FF90525-10	K-27
FF4180-2032S	J-135	FF593-20	J-110	FF90311-400	K-28	FF90525-12	K-27
FF4181-0404S	J-138	FF593-24	J-110	FF90311-422	K-28	FF90525-14	K-27
FF4181-0504S	J-138	FF593-32	J-110	FF90311-445	K-28	FF90525-16	K-27
FF4181-0604S	J-138	FF593-40	J-110	FF90311-483	K-28	FF90525-18	K-27
FF4181-0804S	J-138	FF593-48	J-110	FF90311-508	K-28	FF90525-20	K-27
FF4181-0806S	J-138	FF5943T1212S	J-114	FF90311-572	K-28	FF90525-22	K-27
FF4181-0808S	J-138	FF5943T1616S	J-114	FF90311-635	K-28	FF90525-24	K-27
FF4181-1008S	J-138	FF5945T1212S	J-115	FF90311-700	K-28	FF90525-26	K-27
FF4181-1208S	J-138	FF5945T1612S	J-115	FF90319-12	H-89	FF90525-4	K-27
FF4181-1212S	J-138	FF5945T1616S	J-115	FF90319-16	H-89	FF90525-6	K-27
FF4181-1612S	J-138	FF5945T1620S	J-115	FF90319-20	H-89	FF90525-8	K-27
FF4181-1616S	J-138	FF5945T2020S	J-115	FF90319-24	H-89	FF90526-10	K-27
FF4181-2020S	J-138	FF5945T2424S	J-115	FF90319-32	H-89	FF90526-12	K-27
FF4183-0404-1S	J-62	FF5946T1212S	J-115	FF90519-10	K-27	FF90526-14	K-27
FF4183-0404-2S	J-62	FF5946T1216S	J-115	FF90519-12	K-27	FF90526-16	K-27
FF4183-0606S	J-62	FF5946T1616S	J-115	FF90519-14	K-27	FF90526-18	K-27
FF4184-0404S	J-129	FF5946T2020S	J-115	FF90519-16	K-27	FF90526-20	K-27
FF4184-0606S	J-129	FF5946T2424S	J-115	FF90519-18	K-27	FF90526-22	K-27
FF4184-0808S	J-129	FF595-12	J-110	FF90519-20	K-27	FF90526-24	K-27
FF4184-1010S	J-129	FF595-16	J-110	FF90519-4	K-27	FF90526-26	K-27
FF4184-1212S	J-129	FF595-20	J-110	FF90519-6	K-27	FF90526-4	K-27
FF4185-0804-1S	J-62	FF595-24	J-110	FF90519-8	K-27	FF90526-6	K-27
FF4185-0804-2S	J-62	FF595-32	J-110	FF90520-10	K-27	FF90526-8	K-27
FF4186-0804-1S	J-62	FF6001T1216S	J-114	FF90520-12	K-27	FF90645	L-68
FF4186-0804-2S	J-62	FF6002T1212S	J-114	FF90520-14	K-27	FF90646	L-68
FF4215-0614S	J-132	FF6002T1616S	J-114, J-115	FF90520-16	K-27	FF9075-06	J-57
FF4215-0616S	J-132	FF90102-04S	J-40	FF90520-18	K-27	FF9075-08	J-57
FF4215-0618S	J-132	FF90102-06S	J-40	FF90520-20	K-27	FF9075-09	J-57
FF5162-1212S	J-118	FF90102-08S	J-40	FF90520-22	K-27	FF9075-19	J-57
FF5162-1616S	J-118	FF90102-10S	J-40	FF90520-24	K-27	FF90754-106	K-5
FF5162-1620S	J-118	FF90102-12S	J-40	FF90520-26	K-27	FF90754-122	K-5
FF5162-2016S	J-118	FF90102-16S	J-40	FF90520-4	K-27	FF90754-142	K-5
FF5162-2020S	J-118	FF90102-20S	J-40	FF90520-6	K-27	FF90754-157	K-5
FF5162-2424S	J-118	FF90102-24S	J-40	FF90520-8	K-27	FF90754-173	K-5
FF5162-3232S	J-118	FF90103-04S	J-40	FF90521-10	K-27	FF90754-185	K-5
FF5163-0808S	J-99	FF90103-06S	J-40	FF90521-12	K-27	FF90754-209	K-5

Part number	page	Part number	page	Part number	page	Part number	page
FF90754-219	K-5	FF9768-20S	J-56	FJ3054-1212S	I-34	FJ3134-03-1010S	I-41
FF90754-238	K-5	FF9768-24S	J-56	FJ3054-1216S	I-34	FJ3135-01-1010S	I-41
FF90754-288	K-5	FF9807-XX	J-113	FJ3055-01-0606S	I-33	FJ3135-02-1012S	I-41
FF90754-366	K-5	FF9855-XX	J-113	FJ3055-02-0608S	I-33	FJ3136-0810S	I-45
FF90754-68	K-5	FF9863-04S	J-56	FJ3055-03-0808S	I-33	FJ3149-01-0606S	I-43
FF90754-79	K-5	FF9863-06S	J-56	FJ3055-04-0810S	I-33	FJ3149-02-0608S	I-43
FF90754-91	K-5	FF9863-08S	J-56	FJ3055-05-1010S	I-33	FJ3149-03-0808S	I-43
FF90754-98	K-5	FF9863-10S	J-56	FJ3055-06-1012S	I-33	FJ3149-0404S	I-43
FF9075-74	J-57	FF9863-12S	J-56	FJ3055-07-1212S	I-33	FJ3149-04-1010S	I-43
FF9075-86	J-57	FF9863-16S	J-56	FJ3055-08-1016S	I-33	FJ3149-05-1012S	I-43
FF9075-87	J-57	FF9863-20S	J-56	FJ3055-09-1216S	I-33	FJ3149-06-1212S	I-43
FF9075-88	J-57	FF9863-24S	J-56	FJ3056-01-0606S	I-42	FJ3149-07-0810S	I-43
FF91042	L-22	FF9872-04	I-61	FJ3056-02-0808S	I-42	FJ3161-01-0606S	I-44
FF91042	L-22	FF9895-XX	J-112	FJ3056-03-1010S	I-42	FJ3161-02-0808S	I-44
FF91420	L-68	FH-135X	L-57	FJ3056-04-0810S	I-42	FJ3161-03-1010S	I-44
FF91455	L-22	FH-15X	L-57	FJ3056-05-0608S	I-42	FJ3161-04-1008S	I-44
FF91488-0406S	J-135	FH-40X	L-57	FJ3057-01-0606S	I-42	FJ3161-05-0404S	I-44
FF91488-0508S	J-135	FH-72X	L-58	FJ3057-02-0608S	I-42	FJ3162-0808S	I-35
FF91488-0610S	J-135	FITT. #30	H-94, H-100	FJ3057-03-0808S	I-42	FJ3162-0810S	I-35
FF91488-0812S	J-135	FITT. #31	H-94	FJ3057-04-0810S	I-42	FJ3162-1010S	I-35
FF91488-1014S	J-135	FITT. #32	H-94, H-100	FJ3057-05-1010S	I-42	FJ3162-1012S	I-35
FF91488-1015S	J-135	FITT. #33	H-94, H-100	FJ3057-06-1012S	I-42	FJ3162-1016S	I-35
FF91488-1016S	J-135	FITT. #34	H-94, H-100	FJ3057-07-1212S	I-42	FJ3162-1212S	I-35
FF91488-1218S	J-135	FITT. #35	H-94, H-100	FJ3057-08-0806S	I-42	FJ3163-01-1010S	I-38
FF91488-1420S	J-135	FITT. #40	H-96, H-100	FJ3058-01-0606S	I-51	FJ3163-02-1212S	I-38
FF91488-2030S	J-135	FITT. #41	H-96	FJ3058-02-0808S	I-51	FJ3171-0606S	I-51
FF91488-2032S	J-135	FITT. #60	H-95	FJ3058-03-1010S	I-51	FJ3171-0808S	I-51
FF91494-12S	J-64	FJ3012-01-1012S	I-37	FJ3058-04-1212S	I-51	FJ3171-1010S	I-51
FF91494-16S	J-64	FJ3012-02-1010S	I-37	FJ3058-05-1010S	I-51	FJ3171-1212S	I-51
FF91494-2S	J-64	FJ3012-03-1212S	I-37	FJ3058-06-1212S	I-51	FJ3171-1616S	I-51
FF91494-4S	J-64	FJ3012-04-1216S	I-37	FJ3058-1010C	I-42	FJ3192-02-1212S	I-45
FF91494-6S	J-64	FJ3012-05-1016S	I-37	FJ3058-1616C	I-42	FJ3225-1008S	I-48
FF91494-8S	J-64	FJ3013-01-0810S	I-37	FJ3059-01-0606S	I-43	FJ3225-1010S	I-48
FF9173-04S	J-120	FJ3013-02-0606S	I-37	FJ3059-02-0608S	I-43	FJ3225-1012S	I-48
FF9173-06S	J-120	FJ3013-03-0808S	I-37	FJ3059-03-0808S	I-43	FJ3226-1010S	I-49
FF9173-08S	J-120	FJ3013-06-1010S	I-37	FJ3059-0404S	I-43	FJ3230-01-0810S	I-36
FF9173-10S	J-120	FJ3019-01-1012S	I-40	FJ3059-04-0810S	I-43	FJ3230-02-1012S	I-36
FF9173-12S	J-120	FJ3019-02-0608S	I-40	FJ3059-05-1010S	I-43	FJ3230-03-0808S	I-36
FF9173-16S	J-120	FJ3019-03-0606S	I-40	FJ3059-06-1012S	I-43	FJ3230-04-1010S	I-36
FF9446-XX	J-113	FJ3019-04-0808S	I-40	FJ3066	I-52	FJ3230-05-1016S	I-36
FF9446-XXX	J-111, J-112	FJ3019-05-1212S	I-40	FJ3066-0606S	I-52	FJ3230-06-1216S	I-36
FF9605-03S	J-126	FJ3019-06-0810S	I-40	FJ3066-060808S	I-52	FJ3274-1010S	I-47
FF9605-04S	J-126	FJ3019-07-1010S	I-40	FJ3066-0808S	I-52	FJ3274-1012S	I-47
FF9605-05S	J-126	FJ3019-09-1216S	I-40	FJ3066-1010S	I-52	FJ3288-01-0606S	I-34
FF9605-06S	J-126	FJ3019-10-1016S	I-40	FJ3066-101212S	I-52	FJ3288-02-0808S	I-34
FF9605-08S	J-126	FJ3026-0606S	I-41	FJ3066-1212S	I-52	FJ3288-03-0806S	I-34
FF9605-10S	J-126	FJ3026-0808S	I-41	FJ3066-1616S	I-52	FJ3288-04-0810S	I-34
FF9605-12S	J-126	FJ3026-1010S	I-41	FJ3067-1212S	I-47	FJ3288-05-1016S	I-34
FF9605-16S	J-126	FJ3026-1012S	I-41	FJ3111-01-0808S	I-45	FJ3288-06-1216S	I-34
FF9605-20S	J-126	FJ3026-1212S	I-41	FJ3111-02-0810S	I-45	FJ3288-07-1012S	I-34
FF9605-24S	J-126	FJ3045-0606S	I-50	FJ3111-03-0806S	I-45	FJ3288-08-1212S	I-34
FF9605-32S	J-126	FJ3045-0808S	I-50	FJ3112-01-0808S	I-46	FJ3288-11-1010S	I-34
FF9766-04S	J-57	FJ3045-1008S	I-50	FJ3112-02-0810S	I-46	FJ3288-13-1216S	I-34
FF9766-06S	J-57	FJ3045-1010S	I-50	FJ3112-03-0806S	I-46	FJ3289-01-0808S	I-38
FF9766-08S	J-57	FJ3045-1212S	I-50	FJ3112-03-1010S	I-46	FJ3289-02-1010S	I-38
FF9766-10S	J-57	FJ3045-1616S	I-50	FJ3113-0810S	I-47	FJ3289-03-0606S	I-38
FF9766-12S	J-57	FJ3047-1012S	I-38	FJ3116-01-0606S	I-40	FJ3289-04-0810S	I-38
FF9766-16S	J-57	FJ3047-1016S	I-38	FJ3116-02-1010S	I-40	FJ3289-05-1012S	I-38
FF9766-20S	J-57	FJ3052-0606S	I-39	FJ3116-03-0808S	I-40	FJ3289-06-1216S	I-38
FF9766-24S	J-57	FJ3052-0608S	I-39	FJ3116-04-0608S	I-40	FJ3301-01-0606S	I-46
FF9767T04-S	J-56	FJ3052-0808S	I-39	FJ3116-05-1012S	I-40	FJ3319-1212S	I-45
FF9767T06-S	J-56	FJ3052-0810S	I-39	FJ3116-06-1212S	I-40	FJ3363-01-1012S	I-36
FF9767T08-S	J-56	FJ3052-1010S	I-39	FJ3116-07-1216S	I-40	FJ3363-02-0810S	I-36
FF9767T10-S	J-56	FJ3052-1012S	I-39	FJ3116-08-1016S	I-40	FJ3363-03-0808S	I-36
FF9767T12-S	J-56	FJ3052-1016S	I-39	FJ3131-01-0606S	I-40	FJ3365-01-1012S	I-36
FF9767T16-S	J-56	FJ3052-1212S	I-39	FJ3131-02-0808S	I-40	FJ3366-01-0810S	I-43
FF9767T20-S	J-56	FJ3052-1216S	I-39	FJ3131-03-1010S	I-40	FJ3366-02-0808S	I-43
FF9767T24-S	J-56	FJ3053-0606S	I-34	FJ3132-01-1010S	I-40	FJ3408-0808S	I-33
FF9768-04S	J-56	FJ3053-0806S	I-34	FJ3132-02-1012S	I-40	FJ3408-0810S	I-33
FF9768-06S	J-56	FJ3053-0808S	I-34	FJ3133-01-0606S	I-43	FJ3408-1212S	I-33
FF9768-08S	J-56	FJ3053-0810S	I-34	FJ3133-02-0808S	I-43	FJ3409-1210S	I-45
FF9768-10S	J-56	FJ3054-1010S	I-34	FJ3133-03-1010S	I-43	FJ3409-1212S	I-45
FF9768-12S	J-56	FJ3054-1012S	I-34	FJ3134-01-0606S	I-41	FJ3416-01-1010S	I-35
FF9768-16S	J-56	FJ3054-1016	I-34	FJ3134-02-0808S	I-41	FJ3416-02-0808S	I-35

Index

Part number index

M

Part number	page	Part number	page	Part number	page	Part number	page
FJ3427-0808S	I-52	FJ3983-0806S	I-55	FS-700	L-68	FT1380-2-9	L-9
FJ3427-1010S	I-52	FJ5984-0606S	I-33	FS-800	L-68	FT1380-4	L-9
FJ3428-1212S	I-52	FJ5984-0608S	I-33	FT1209-200-14	L-14	FT1380-XL	L-9
FJ3428-1616S	I-52	FJ5984-0808S	I-33	FT1209-200-15	L-12, L-14	FT1381-200-M280	L-4, L-8
FJ3444-1010S	I-39	FJ5984-0810S	I-33	FT1209-200-16	L-14	FT1382-200-M465	L-4, L-8
FJ3460-01-1010S	I-39	FJ5984-1008S	I-33	FT1209-200-20	L-14	FT1382-275-M370	L-9
FJ3460-02-1012S	I-39	FJ5984-1010S	I-33	FT1209-200-21	L-14	FT1382-275-M520	L-9
FJ3460-03-1212S	I-39	FJ5984-1012S	I-33	FT1209-200-23	L-14	FT1390	L-12
FJ3461-01-1010S	I-35	FJ5984-1016S	I-33	FT1209-200-46	L-12	FT1390-115	L-13
FJ3461-02-1012S	I-35	FJ5984-1210S	I-33	FT1209-200-82	L-12	FT1390-115-12	L-13
FJ3461-03-1212S	I-35	FJ5984-1212S	I-33	FT1209-2-9	L-14	FT1390-115CSA	L-13
FJ3495-0808S	I-47	FJ5984-1216S	I-33	FT1307-200-M070	L-14	FT1390-200-14	L-12
FJ3496-01-1010S	I-51	FJ5985-0606S	I-34	FT1307-200-M090	L-14	FT1390-200-15	L-12
FJ3496-02-0808S	I-51	FJ5985-0608S	I-34	FT1307-200-M120	L-14	FT1390-200-16	L-12
FJ3496-03-1012S	I-51	FJ5985-0806S	I-34	FT1307-200-M150	L-12	FT1390-200-20	L-12
FJ3496-04-0608S	I-51	FJ5985-0808S	I-34	FT1307-200-M180	L-12	FT1390-200-21	L-12
FJ3508-0404C	I-42	FJ5985-0810S	I-34	FT1307-200-M210	L-12	FT1390-200-23	L-12
FJ3508-0808C	I-42	FJ5985-1010S	I-34	FT1307-200-M240	L-12	FT1390-230	L-13
FJ3510-1012S	I-49	FJ5985-1012S	I-34	FT1307-200-M280	L-12	FT1390-230CSA	L-13
FJ3511-1010S	I-49	FJ5985-1210S	I-34	FT1307-200-M320	L-12	FT1390-2-9	L-14
FJ3513-0606S	I-50	FJ5985-1212S	I-34	FT1307-200-M370	L-12	FT1392-200-R5-24	L-14
FJ3513-0808S	I-50	FJ5985-1216S	I-34	FT1307-200-M420	L-12	FT1392-200-R5-32	L-14
FJ3513-1010S	I-50	FJ5986-1010S	I-52	FT1307-200-M465	L-12	FT1406	I-61
FJ3513-1212S	I-50	FJ5986-1212S	I-52	FT1307-200-M520	L-12	FT1421	I-61
FJ3513-1216S	I-50	FJ5986-1616S	I-52	FT1307-200-M550	L-12	FT1455	L-40
FJ3514-0606S	I-50	FJ5994-01-0606S	I-44	FT1307-200-M690	L-12	FT1455-4FFORX	L-43, L-46
FJ3514-0608S	I-50	FJ5994-02-0808S	I-44	FT1307-200-R5-04	L-14	FT1455-CC	L-45
FJ3514-0808S	I-50	FJ5994-03-1212S	I-44	FT1307-200-R5-05	L-14	FT1455-J-06	L-43
FJ3514-1010S	I-50	FJ5994-04-1010S	I-44	FT1307-200-R5-06	L-14	FT1455-J-10	L-43
FJ3514-1012S	I-50	FJ5994-05-0406S	I-44	FT1307-200-R5-08	L-14	FT1455-J-13	L-43
FJ3514-1212S	I-50	FJ5994-05-1012S	I-44	FT1307-200-R5-10	L-14	FT1455-J-16	L-43
FJ3514-1216S	I-50	FJ5994-07-0806S	I-44	FT1307-200-R5-12	L-14	FT1455-J-19	L-43
FJ3568-1008S	I-50	FJ5994-09-1016S	I-44	FT1307-200-R5-16	L-14	FT1455-J-25	L-43
FJ3568-1010S	I-50	FJ5995-0606S	I-51	FT1307-200-R5-20	L-14	FT1455-J-32	L-43
FJ3568-1012S	I-50	FJ5995-0808S	I-51	FT1307-200-R5-24	L-14	FT1455-J-38	L-43
FJ3611-01-0808S	I-41	FJ5995-1010S	I-51	FT1307-200-R5-32	L-14	FT1455-J-50	L-43
FJ3623-0808S	I-53	FJ5995-1212S	I-51	FT1307-2-9	L-14	FT1455-J-XX	L-43, L-47
FJ3624-0808S	I-53	FJ8732-0404S	I-4, I-7	FT1312	L-39	FT1455-K1	L-42
FJ3632-0606S	I-33	FJ8732-0606S	I-4, I-7	FT1330-XL	L-9	FT1455-K2	L-42
FJ3632-0806S	I-33	FJ8732-0808S	I-4, I-7	FT1341	L-61	FT1455-K3	L-42
FJ3632-0808S	I-33	FJ8732-1212S	I-4, I-7	FT1355-A-XX	L-47, L-48,	FT1455-K4	L-42
FJ3632-1010S	I-33	FJ8732-1616S	I-4, I-7	L-50, L-51		FT1455-K5	L-42
FJ3632-1012S	I-33	FJ8733-0404S	I-4, I-7	FT1355-H-XX	L-46 – L-49,	FT1455-L1	L-41
FJ3632-1212S	I-33	FJ8733-0606S	I-4, I-7	L-51, L-52		FT1455-L2	L-41
FJ3731-0404S	I-42	FJ8733-0808S	I-4, I-7	FT1355-T-XX	L-47, L-48,	FT1455-L2-AR1	L-44
FJ3731-0606S	I-42	FJ8733-1212S	I-4, I-7	L-50, L-51		FT1455-L3	L-41
FJ3731-0808S	I-42	FJ8733-1616S	I-4, I-7	FT1356	I-61, I-62	FT1455-L3-AR2	L-44
FJ3731-1010S	I-42	FJ8734-0404S	I-4, I-7	FT1356-2-1	I-61	FT1455-L3-AR3	L-44
FJ3731-1212S	I-42	FJ8734-0606S	I-4, I-7	FT1357	I-61, I-62, I-64	FT1455-L3-LR	L-44
FJ3731-1616S	I-42	FJ8734-0808S	I-4, I-7	FT1380	L-8	FT1455-L4	L-41
FJ3734-1212S	I-54	FJ8734-1212S	I-4, I-7	FT1380-115	L-8	FT1455-N-45	L-43, L-46
FJ3801-1212S	I-54	FJ8734-1616S	I-4, I-7	FT1380-115-8	L-8	FT1455-NH25	L-45
FJ3804-0606S	I-53	FJ8735-0404S	I-4, I-7	FT1380-115CSA	L-8	FT1455-N-HXX	L-43, L-46, L-47
FJ3804-1010S	I-53	FJ8735-0606S	I-4, I-7	FT1380-200-M150	L-4, L-8	FT1455-NT-XX	L-43
FJ3804-1012S	I-53	FJ8735-0808S	I-4, I-7	FT1380-200-M180	L-4, L-8	FT1455-NT-XXXXX	L-43, L-48
FJ3890-01-0806S	I-46	FJ8735-1212S	I-4, I-7	FT1380-200-M210	L-4, L-8	FT1455-N-U55	L-43, L-46, L-47
FJ3891-01-1010S	I-46	FJ8735-1616S	I-4, I-7	FT1380-200-M240	L-4, L-8	FT1455-OC	L-45
FJ3892-01-1010S	I-46	FL-310	L-59	FT1380-200-M320	L-4, L-8	FT1555	L-53
FJ3914-02-1212S	I-54	FS-100	L-68	FT1380-200-M370	L-4, L-8	FT1555-BM	L-54
FJ3914-03-1210S	I-54	FS-1200	L-20, L-68	FT1380-200-M420	L-4, L-8	FT1555-HH	L-54
FJ3914-04-0806S	I-54	FS-1500	L-20, L-68	FT1380-230	L-8	FT1555-HH-D15	L-56
FJ3970-0606S	I-54	FS-1600	L-68	FT1380-230CSA	L-8	FT1555-HH-D20	L-56
FJ3970-0808S	I-54	FS-200	L-68	FT1380-2-4	L-9	FT1555-HH-K1	L-55
FJ3970-1212S	I-54	FS-2000	L-68	FT1380-275-M070	L-9	FT1555-HH-K2	L-55
FJ3970-1616S	I-54	FS-2300	L-68	FT1380-275-M090	L-9	FT1555-HH-K3	L-55
FJ3977-0806S	I-55	FS-2400	L-68	FT1380-275-M120	L-9	FT1555-HH-ST	L-56
FJ3977-0810S	I-55	FS-2800	L-68	FT1380-275-R5-04	L-9	FT1555-XXXXUP	L-56
FJ3977-1012S	I-55	FS-2900	L-21, L-68	FT1380-275-R5-05	L-9	GA23854-12-16	I-57
FJ3978-1012S	I-56	FS-300	L-68	FT1380-275-R5-06	L-9	GA23911-10-10	I-44
FJ3979-1012S	I-56	FS-3200	L-68	FT1380-275-R5-08	L-9	GA23911-10-12	I-44
FJ3980-0810S	I-55	FS-3300	L-68	FT1380-275-R5-10	L-9	GA23911-12-12	I-44
FJ3981-1012S	I-56	FS-400	L-68	FT1380-275-R5-12	L-9	GA23911-16-16	I-44
FJ3982-0806S	I-55	FS-500	L-68	FT1380-275-R5-16	L-9	GA23911-4-4	I-44
FJ3982-0810S	I-55	FS-600	L-68	FT1380-275-R5-20	L-9	GA23911-6-6	I-44

Part number	page	Part number	page	Part number	page	Part number	page
GA23911-8-8	I-44	GG308-NP04-10	J-133	H01708	C-4	H06905	F-13
GA23912-10-10	I-44	GG308-NP04-12	J-133	H01708-250R	C-4	H06905-250R	F-13
GA23912-10-8	I-44	GG308-NP06-14	J-133	H01712	C-4	H06906	F-13
GA23912-12-12	I-44	GG308-NP06-16	J-133	H01712-250R	C-4	H06906-250R	F-13
GA23912-8-8	I-44	GG308-NP08-18	J-133	H01716	C-4	H06908	F-13
GA23913-10-12	I-44	GG308-NP08-22	J-133	H01716-250R	C-4	H06908-250R	F-13
GA23913-4-4	I-44	GG308-NP10-18	J-133	H01720	C-4	H06910	F-13
GA24127-24	I-30	GG308-NP10-20	J-133	H0319	D-6	H06910-250R	F-13
GA24335-16-12	I-58	GG308-NP10-22	J-133	H0345	D-3	H06912	F-13
GA24335-22-16	I-58	GG308-NP12-22	J-133	H0346	D-3	H06912-250R	F-13
GA24336-16-12	I-58	GG308-NP12-27	J-133	H0347	D-6	H06916	F-13
GA24336-22-16	I-58	GG308-NP16-33	J-133	H0349	D-6	H06916-250R	F-13
GA24337-16-12	I-58	GG310-NP04-04	J-138	H0350	D-4	H06920	F-13
GA24337-22-16	I-58	GG310-NP05-04	J-138	H0363	D-7	H06920-150	F-13
GA25126-16	I-30	GG310-NP06-04	J-138	H0364	D-10	H06924	F-13
GA25126-20	I-30	GG310-NP06-06	J-138	H0372	D-8	H06924-100	F-13
GA25126-24	I-30	GG310-NP06-08	J-138	H0377	D-7	H06932	F-13
GA25127-16	I-30	GG310-NP08-06	J-138	H0378	D-3	H06932-100	F-13
GA25127-20	I-30	GG310-NP08-08	J-138	H03912	B-27	H06940	F-13
GA25128-16	I-30	GG310-NP10-12	J-138	H03912-100	B-27	H10004	C-5
GA25128-24	I-30	GG310-NP12-12	J-138	H03912-150	B-27	H10004-250R	C-5
GG106-NP04-02	J-136	GG310-NP16-16	J-138	H03916	B-27	H10005	C-5
GG106-NP04-04	J-136	GG310-NP20-20	J-138	H03916-100	B-27	H10005-250R	C-5
GG106-NP04-06	J-136	GH001-10WR	I-60, I-62	H03916-150	B-27	H10006	C-5
GG106-NP04-08	J-136	GH001-10WR250	E-3	H03920	B-27	H10006-250R	C-5
GG106-NP05-04	J-136	GH001-10WR50	E-3	H03920-100	B-27	H10008	C-5
GG106-NP06-04	J-136	GH001-12WR	I-60, I-62	H03920-150	B-27	H10008-250R	C-5
GG106-NP06-06	J-136	GH001-12WR250	E-3	H03924	B-27	H10010	C-5
GG106-NP06-08	J-136	GH001-12WR50	E-3	H03924-100	B-27	H10010-250R	C-5
GG106-NP08-04	J-136	GH001-16WR	I-62	H03924-150	B-27	H10012	C-5
GG106-NP08-06	J-136	GH001-16WR250	E-3	H03932	B-27	H10012-250R	C-5
GG106-NP08-08	J-136	GH001-16WR50	E-3	H03932-100	B-27	H10104	C-6
GG106-NP08-12	J-136	GH001-4WR250	E-3	H03932-150	B-27	H10104-250R	C-6
GG106-NP10-06	J-136	GH001-4WR50	E-3	H039H12	B-28	H10104-500R	C-6
GG106-NP10-08	J-136	GH001-6WR	I-60, I-62	H039H12-100	B-28	H10105	C-6
GG106-NP10-12	J-136	GH001-6WR250	E-3	H039H12-150	B-28	H10105-25	C-6
GG106-NP12-08	J-136	GH001-6WR50	E-3	H039H16	B-28	H10105-250R	C-6
GG106-NP12-12	J-136	GH001-8WR	I-60, I-62	H039H16-100	B-28	H10106	C-6
GG106-NP12-16	J-136	GH001-8WR250	E-3	H039H16-150	B-28	H10106-25	C-6
GG106-NP16-12	J-136	GH001-8WR50	E-3	H039H20	B-28	H10106-250R	C-6
GG106-NP16-16	J-136	GH100-10-250R	F-20	H039H20-100	B-28	H10106-370R	C-6
GG106-NP16-20	J-136	GH100-10-50	F-20	H039H20-150	B-28	H10108	C-6
GG106-NP20-20	J-136	GH100-12-250R	F-20	H039H24	B-28	H10108-250R	C-6
GG108-NP04-10	J-133	GH100-12-50	F-20	H039H24-100	B-28	H10110	C-6
GG108-NP04-12	J-133	GH100-4-250R	F-20	H039H24-150	B-28	H10110-250R	C-6
GG108-NP04-14	J-133	GH100-4-50	F-20	H039H32	B-28	H10112	C-6
GG108-NP06-14	J-133	GH100-6-250R	F-20	H039H32-100	B-28	H10112-250R	C-6
GG108-NP06-16	J-133	GH100-6-50	F-20	H039H32-150	B-28	H1066	D-4
GG108-NP08-18	J-133	GH100-8-250R	F-20	H0521	D-6	H1193	D-7
GG108-NP08-22	J-133	GH100-8-50	F-20	H0523	D-3	H1196	D-10
GG108-NP10-20	J-133	GH101-10-50	F-21	H0554	D-3	H14504	B-21
GG108-NP12-22	J-133	GH101-4-50	F-21	H05703-100R	F-22	H14504-250R	B-21
GG108-NP12-27	J-133	GH101-6-50	F-21	H05703-25R	F-22	H14504-500R	B-21
GG108-NP16-33	J-133	GH101-8-50	F-21	H05704-100R	F-22	H14506	B-21
GG108-NP20-42	J-133	H0034	D-6	H05704-250R	F-22	H14506-250R	B-21
GG110-NP04-02	J-137	H0084	D-9	H05704-25R	F-22	H14506-500R	B-7, B-21
GG110-NP04-04	J-137	H00904-250R	C-3	H05704-500R	F-22	H14508	B-21
GG110-NP06-04	J-137	H00904-25R	C-3	H05705-100R	F-22	H14508-250R	B-21
GG110-NP06-06	J-137	H00904-50R	C-3	H05705-25R	F-22	H14508-500R	B-21
GG110-NP08-06	J-137	H00905-250R	C-3	H05705-500R	F-22	H14510	B-21
GG110-NP08-08	J-137	H00905-25R	C-3	H05706-250R	F-22	H14510-250R	B-21
GG110-NP10-08	J-137	H00905-50R	C-3	H05706-25R	F-22	H14512	B-21
GG110-NP12-12	J-137	H00906-250R	C-3	H05706-50R	F-22	H14512-250R	B-21
GG110-NP16-16	J-137	H00906-25R	C-3	H05904	F-23	H14516	B-21
GG306-NP04-04	J-137	H00906-50R	C-3	H05905	F-23	H14516-250R	B-21
GG306-NP05-04	J-137	H00908	C-3	H05906	F-23	H145R04	B-7
GG306-NP06-04	J-137	H00908-250R	C-3	H05908	F-23	H145R04-250R	B-7
GG306-NP06-06	J-137	H00908-25R	C-3	H05910	F-23	H145R06	B-7
GG306-NP08-06	J-137	H0105	D-2	H05912	F-23	H145R06-250R	B-7
GG306-NP08-08	J-137	H0106	D-2	H05916	F-23	H145R08	B-7
GG306-NP10-12	J-137	H01704	C-4	H0599	D-3	H145R08-250R	B-7
GG306-NP12-12	J-137	H01704-250R	C-4	H0616	D-8	H145R10	B-7
GG306-NP16-16	J-137	H01706	C-4	H06904	F-13	H145R12	B-7
GG306-NP20-20	J-137	H01706-250R	C-4	H06904-250R	F-13	H145R12-250R	B-7

Part number index

M

Part number	page	Part number	page	Part number	page	Part number	page
H16604	F-14	H20106BK-500R	C-7	H27506RD	C-8	H33204-250R	C-8
H16605	F-14	H20108BK	C-7	H27506RD-600R	C-8	H33204-50C	C-8
H16606	F-14	H20108BK-250R	C-7	H27508RD	C-8	H33206-250R	C-8
H16608	F-14	H20108BK-500R	C-7	H27508RD-500R	C-8	H33206-50C	C-8
H16610	F-14	H20110BK	C-7	H27510RD-500R	C-8	H33208-250R	C-8
H16612	F-14	H20110BK-250R	C-7	H27512RD-500R	C-8	H33208-50C	C-8
H16616	F-14	H20112BK	C-7	H27516RD-200R	C-8	H33210-250R	C-8
H16620	F-14	H20112BK-250R	C-7	H27520RD-100	C-8	H33210-50C	C-8
H16906	F-15	H20116BK	C-7	H27524RD-100	C-8	H33212-250R	C-8
H16906-250R	F-15	H20116BK-250R	C-7	H27703	G-4	H33212-50C	C-8
H16908	F-15	H21304	F-16	H27703-150R	G-4	H345	D-10
H16908-250R	F-15	H21304-250R	F-16	H27704	G-4	H34504	B-25
H16910	F-15	H21305	F-16	H27704-100R	G-4	H34504-100	B-25
H16912	F-15	H21305-250R	F-16	H27705	G-4	H34504-250R	B-25
H16916	F-15	H21306	F-16	H27705-100R	G-4	H34504-500R	B-25
H16920	F-15	H21306-250R	F-16	H27706	G-4	H34506	B-25
H16924	F-15	H21308	F-16	H27706-100R	G-4	H34506-100	B-25
H16932	F-15	H21308-250R	F-16	H27708	G-4	H34506-250R	B-25
H1776	D-2	H21310	F-16	H27708-100R	G-4	H34506-500R	B-25
H1777	D-2	H21310-250R	F-16	H27712	G-4	H34508	B-25
H18004	B-6	H21312	F-16	H27716	G-4	H34508-100	B-25
H18004-250R	B-6	H21312-250R	F-16	H28004	B-9	H34508-250R	B-25
H18004-500R	B-6	H21316	F-16	H28004-250R	B-9	H34508-500R	B-25
H18006	B-6	H21316-250R	F-16	H28004-500R	B-9	H36606	F-28
H18006-250R	B-6	H22904	F-17	H28006	B-9	H36606-250R	F-28
H18006-500R	B-6	H22906	F-17	H28006-250R	B-9	H36608	F-28
H18008	B-6	H22906-250R	F-17	H28006-500R	B-9	H40004	B-23
H18008-250R	B-6	H22908	F-17	H28008	B-9	H40004-250R	B-23
H18008-500R	B-6	H22908-250R	F-17	H28008-250R	B-9	H40006	B-23
H18010	B-6	H22910	F-17	H28008-500R	B-9	H40006-250R	B-23
H18010-250R	B-6	H23904	F-18	H28010	B-9	H40008	B-23
H18012	B-6	H23904-250R	F-18	H28010-250R	B-9	H40008-250R	B-23
H18012-250R	B-6	H23906	F-18	H28012	B-9	H40010	B-23
H18016	B-6	H23906-250R	F-18	H28012-250R	B-9	H40010-250R	B-23
H18016-250R	B-6	H23908	F-18	H28016	B-9	H40012	B-23
H18020	B-6	H23908-250R	F-18	H28016-250R	B-9	H40020	B-23
H18024	B-6	H23910	F-18	H28020	B-9	H42104	B-24
H18032	B-6	H23910-250R	F-18	H28020-150	B-9	H42104-250R	B-24
H1812	D-2	H23912	F-18	H28024	B-9	H42106	B-24
H19004	B-19	H23912-250R	F-18	H28024-150	B-9	H42106-250R	B-24
H19004-250R	B-19	H23916	F-18	H28032	B-9	H42908	F-18
H19006	B-19	H23916-250R	F-18	H285	D-4	H42908-250R	F-18
H19006-250R	B-19	H23920	F-18	H29004	B-20	H42910	F-18
H19008	B-19	H23920-250R	F-18	H29004-250R	B-20	H42910-250R	F-18
H19008-250R	B-19	H24303	G-3	H29004-500R	B-20	H43006	B-12
H19010	B-19	H24303-150R	G-3	H29006	B-20	H43006-100	B-12
H19012	B-19	H24304	G-3	H29006-250R	B-20	H43008	B-12
H19012-250R	B-19	H24304-100R	G-3	H29006-500R	B-20	H43008-100	B-12
H19016	B-19	H24305	G-3	H29008	B-20	H43008-150	B-12
H19016-250R	B-19	H24305-100R	G-3	H29008-250R	B-20	H43010	B-12
H19020	B-19	H24306	G-3	H29008-500R	B-20	H43012	B-12
H19024	B-19	H24306-100R	G-3	H29010	B-20	H43012-100	B-12
H19032	B-19	H24308	G-3	H29010-250R	B-20	H43012-150	B-12
H190H04	B-8	H24308-100R	G-3	H29012	B-20	H43016	B-12
H190H06	B-8	H24312	G-3	H29012-250R	B-20	H43016-100	B-12
H190H08	B-8	H24316	G-3	H29016	B-20	H43016-150	B-12
H190H10	B-8	H245L04	B-11	H29016-250R	B-20	H43020	B-12
H190H12	B-8	H245L04-250R	B-11	H29020	B-20	H43020-100	B-12
H190H16	B-8	H245L06	B-11	H29020-150R	B-20	H43020-150	B-12
H190H20	B-8	H245L06-250R	B-11	H29024	B-20	H43024	B-12
H190H24	B-8	H245L08	B-11	H29032	B-20	H43024-100	B-12
H190H32	B-8	H245L08-250R	B-11	H290H04	B-10	H43024-150	B-12
H1941	D-3	H245L10	B-11	H290H06	B-10	H43032	B-12
H1942	D-3	H245L10-250R	B-11	H290H06-250R	B-10	H43032-100	B-12
H1981	D-2	H245L12	B-11	H290H08	B-10	H430R06	B-13
H1982	D-2	H245L12-250R	B-11	H290H08-250R	B-10	H430R08	B-13
H201	D-2	H245L16	B-11	H290H10	B-10	H430R10	B-13
H20104BK	C-7	H245L16-250R	B-11	H290H12	B-10	H430R12	B-13
H20104BK-250R	C-7	H245L20	B-11	H290H12-250R	B-10	H430R16	B-13
H20104BK-500R	C-7	H245L24	B-11	H290H16	B-10	H430R20	B-13
H20105GY-250R	C-7	H245L32	B-11	H290H20	B-10	H430R24	B-13
H20105GY-500R	C-7	H275	D-2	H290H24	B-10	H430R32	B-13
H20106BK	C-7	H27504RD	C-8	H290H32	B-10	H46412	B-26
H20106BK-250R	C-7	H27504RD-600R	C-8	H32406	F-27	H46416	B-26

Part number	page	Part number	page	Part number	page	Part number	page
H46420	B-26	H9690	D-8	NF4-5-B	H-100	NM4-5-B	H-100
H46424	B-26	H9949	D-2	NF4-5-S	H-100	NM4-5-C	H-100
H46432	B-26	HD-1X	L-58	NG-10TW	F-29	NM4-5-S	H-100
H47112	B-15	HD-2X	L-58	NG-6TW	F-29	NM4-6	H-98
H47116	B-15	HK0509	K-6	NG-8TW	F-29	NM4-6-B	H-100
H47120	B-15	HK0709	K-6	NJ-10	H-99	NM4-6-C	H-100
H47124	B-15	HK0809	K-6	NJ-12	H-99	NM4-6-S	H-100
H47132	B-15	HK0913	K-6	NJ-16	H-99	NM6-6	H-98
H504	G-7	HK1013	K-6	NJ-20	H-99	NM6-6-B	H-100
H506	G-7	HK1113	K-6	NJ-4	H-99	NM6-6-C	H-100
H508	G-7	HK1213	K-6	NJ-5	H-99	NM6-6-S	H-100
H510	G-7	HK1313	K-6	NJ-6	H-99	NM6-8	H-98
H512	G-7	HK1413	K-6	NJ-8	H-99	NM6-8-B	H-100
H516	G-7	HK1513	K-6	NJC-10	H-99	NM6-8-C	H-100
H520	G-7	HK1613	K-6	NJC-12	H-99	NM6-8-S	H-100
H524	G-7	HK1713	K-6	NJC-16	H-99	NM8-10	H-98
H54504	B-22	HK1813	K-6	NJC-20	H-99	NM8-10-B	H-100
H54504-250R	B-22	HK1913	K-6	NJC-4	H-99	NM8-10-C	H-100
H54504-500R	B-22	HK2017	K-6	NJC-5	H-99	NM8-10-S	H-100
H54506	B-22	HK2117	K-6	NJC-6	H-99	NM8-6-B	H-100
H54506-250R	B-22	HK2317	K-6	NJC-8	H-99	NM8-6-C	H-100
H54506-500R	B-22	HK2517	K-6	NJIC-10-B	H-100	NM8-6-S	H-100
H54508	B-22	HK2617	K-6	NJIC-10-C	H-100	NM8-8	H-98
H54508-250R	B-22	HK2917	K-6	NJIC-10-S	H-100	NM8-8-B	H-100
H54508-500R	B-22	HK3117	K-6	NJIC-12-B	H-100	NM8-8-C	H-100
H54510	B-22	HK3217	K-6	NJIC-12-C	H-100	NM8-8-S	H-100
H54510-250R	B-22	HK3317	K-6	NJIC-12-S	H-100	NMC-10-B	H-100
H54512	B-22	HK3417	K-6	NJIC-16-B	H-100	NNJ-10	H-99
H54512-250R	B-22	HK3817	K-6	NJIC-16-C	H-100	NNJ-12	H-99
H54516	B-22	HP4	K-23	NJIC-16-S	H-100	NNJ-16	H-99
H54516-250R	B-22	HP6	K-23	NJIC-20-B	H-100	NNJ-20	H-99
H56904	F-19	HP8	K-23	NJIC-20-C	H-100	NNJ-4	H-99
H56904-250R	F-19	HPM	K-23	NJIC-20-S	H-100	NNJ-5	H-99
H56905	F-19	HSM-48	K-23	NJIC-3-B	H-100	NNJ-6	H-99
H56905-250R	F-19	NC-10	H-98	NJIC-3-S	H-100	NNJ-8	H-99
H56906	F-19	NC-10-B	H-100	NJIC4-3-B	H-100	NPS-5-C	H-100
H56906-250R	F-19	NC-10-C	H-100	NJIC4-3-S	H-100	NPT45-4-S	H-100
H56908	F-19	NC-10-S	H-100	NJIC-4-C	H-100	NPT90-4-S	H-100
H56908-250R	F-19	NC-12	H-98	NJIC-4-S	H-100	NPTS-4-S	H-100
H56910	F-19	NC-12-B	H-100	NJIC-5-B	H-100	NSAE-10-B	H-100
H56910-250R	F-19	NC-12-C	H-100	NJIC-5-C	H-100	NSAE-12-B	H-100
H56912	F-19	NC-12-S	H-100	NJIC-5-S	H-100	NSAE-4-B	H-100
H56912-250R	F-19	NC-16	H-98	NJIC-6-B	H-100	NSAE-6-B	H-100
H56916	F-19	NC-16-B	H-100	NJIC-6-C	H-100	NSAE-8-B	H-100
H56916-250R	F-19	NC-16-C	H-100	NJIC-6-S	H-100	PB	L-67
H56920	F-19	NC-16-S	H-100	NJIC-8-B	H-100	PD-15	L-57
H56920-250R	F-19	NC-16Z	H-98	NJIC-8-C	H-100	PD-20	L-57
H6009	D-2	NC-16Z-B	H-100	NJIC-8-S	H-100	PD-40	L-57
H6009	D-7	NC-16Z-C	H-100	NJICSAE-4-B	H-100	PD-95	L-57
H75706	E-4	NC-16Z-S	H-100	NM12-12	H-98	PT200	D-4
H75706-100	E-4	NC-20Z	H-98	NM12-12-B	H-100	PT-45-4	H-97, H-100
H75706-250	E-4	NC-20Z-B	H-100	NM12-12-C	H-100	PT-90-4	H-97, H-100
H75708	E-4	NC-20Z-C	H-100	NM12-12-S	H-100	PT-S-4	H-96, H-100
H75708-100	E-4	NC-20Z-S	H-100	NM16-16	H-98	QC-18	L-65
H75708-250	E-4	NC-3-B	H-100	NM16-16-B	H-100	QC-180	L-65
H75710	E-4	NC-3-S	H-100	NM16-16-C	H-100	QC-1800	L-65
H75710-100	E-4	NC-4	H-98	NM16-16-S	H-100	R12-Z56	H-21
H75710-250	E-4	NC-4-B	H-100	NM16-16-S	H-100	R12-Z58	H-21
H75712	E-4	NC-4-C	H-100	NM20-20	H-98	R12-Z60	H-21
H75712-100	E-4	NC-4-S	H-100	NM20-20-B	H-100	R12-Z62	H-21
H75712-250	E-4	NC-5	H-98	NM20-20-C	H-100	R12-Z96	H-21
H8811	D-8	NC-5-B	H-100	NM20-20-S	H-100	R12-Z97	H-21
H900	D-5	NC-5-C	H-100	NM2-3-B	H-100	R12-Z98	H-21
H90004-500R	F-28	NC-5-S	H-100	NM2-3-S	H-100	R12-Z99	H-21
H90006-500R	F-28	NC-6	H-98	NM2-4	H-98	S-10	G-5
H90008-500R	F-28	NC-6-B	H-100	NM2-4-B	H-100	S-1103	H-100
H90012-500R	F-28	NC-6-C	H-100	NM2-4-C	H-100	S-1104-1	H-100
H90016-150	F-28	NC-6-S	H-100	NM2-4-S	H-100	S-1104-2	H-100
H90016-300R	F-28	NC-8	H-98	NM2-5-B	H-100	S-1105	H-100
H901	D-7	NC-8-B	H-100	NM4-4	H-98	S-1106-1	H-100
H9568	D-9	NC-8-C	H-100	NM4-4-B	H-100	S-1106-2	H-100
H9603	D-8	NC-8-S	H-100	NM4-4-C	H-100	S-1106-3	H-100
H9610	D-4	NF2-4-B	H-100	NM4-4-S	H-100	S-1108-1	H-100
H9673	D-4	NF4-4-B	H-100	NM4-5	H-98	S-1108-2	H-100

Index

Part number index

M

Part number	page	Part number	page	Part number	page	Part number	page
S-1110	H-100	T-1060A	L-24	T-420-002	L-11	TA-1004	L-61
S-1112	H-100	T-1070	L-24, L-36	T-420-002CSA	L-11	TC-20	L-58
S-1116	H-100	T-1071	L-24, L-36	T-420-1	L-11	T-J12	L-25
S-1116Z	H-100	T-1072	L-24, L-36	T-420-1CSA	L-11	T-J16	L-25
S-1120Z	H-100	T-1100	L-38	T-420-1M	L-22	T-J24	L-25
S-12	G-5	T-1106	L-38	T-420-26	L-22	T-J32	L-25
S-1303	H-100	T-1110	L-38	T-420-28	L-22	T-J6	L-25
S-1303-4	H-100	T-1116	L-38	T-420-2K	L-22	T-JS10	L-25
S-1304	H-100	T-1124	L-38	T-420-2R	L-22	T-JS4	L-25
S-1305	H-100	T-1132	L-38	T-420-2S	L-22	T-JS5	L-25
S-1306	H-100	T-135	L-36	T-420-B	L-22	T-JS8	L-25
S-1308	H-100	T-135B	L-36	T-420-G	L-22	T-S12	L-25
S-1310	H-100	T-191	L-36	T-420-GT	L-31	T-S6	L-25
S-1312	H-100	T-191B	L-36	T-420-H	L-22	W14630	K-16
S-1316	H-100	T-201	L-26	T-420-L	L-22	W44034	K-17
S-1316Z	H-100	T-201B	L-26	T-420-LA	L-22	W44038	K-17
S-1320Z	H-100	T-300	L-25	T-420-LS	L-22	W44040	K-17
S-16	G-5	T-300X	L-25	T-420-P	L-22	W44042	K-17
S-16Z	G-5	T-301	L-25	T-420-S	L-22	W44048	K-17
S-20Z	G-5	T-400-102C	L-21	T-421-FP	L-28, L-30	W44050	K-17
S-2105	H-100	T-400-103C	L-21	T-421U	L-28	W44052	K-17
S-3	G-5	T-400-104	L-21	T-421U-110	L-28	W44054	K-17
S316-12	G-5	T-400-105C	L-21	T-421U-BC	L-28, L-29	W44067	K-17
S316-16	G-5	T-400-106C	L-21	T-432-15	L-24	W76150	K-16
S316-4	G-5	T-400-107C	L-21	T-441	L-29	W79850	K-16
S316-6	G-5	T-400-108C	L-21	T-450B	L-22	W79851	K-16
S316-8	G-5	T-400-113C	L-20	T-450-D1	L-22	W-EQCR-TD003-E	L-24
S-4	G-5	T-400-114	L-21	T-450K	L-22	W-EQCR-TE006-E	L-22
S-5	G-5	T-400-13	L-24	T-450-P	L-22	W-EQCR-TE009-E	L-22
S-6	G-5	T-400-137	L-21	T-450-Q	L-22	W-EQCR-TE010-E	L-22
S-8	G-5	T-400-14	L-24	T-450R	L-22	W-EQCR-TE012-E	L-23
SA-1	L-66	T-400-19	L-24	T-450S	L-22	W-EQCR-TE011-E	L-22
SA-2	L-66	T-400-30	L-20	T-460-16	L-22	W-EQCR-TM004-E	L-22
SC-10	G-6	T-400-31C	L-20	T-460-2	L-22, L-27	W-EQCR-TM008-E	L-22
SC-12	G-6	T-400-32C	L-20	T-460-P	L-22	W-EQCR-TM013-E	L-23
SC-16	G-6	T-400-33C	L-20	T-460-SF	L-22	WTT024	K-17
SC-3	G-6	T-400-34C	L-20	T-460-SP	L-22	WTT036	K-17
SC316-12	G-6	T-400-35C	L-20	T-460-SPK	L-22	WTT236	K-17
SC316-16	G-6	T-400-36C	L-20	T-460-SPR	L-22	ZW74706	H-21
SC316-4	G-6	T-400-54C	L-20	T-462-16	L-22	ZW74708	H-21
SC316-6	G-6	T-400-55C	L-20	T-462-2	L-22, L-30	ZW74710	H-21
SC316-8	G-6	T-400-56C	L-20	T-462-V	L-22	ZW74712	H-21
SC-4	G-6	T-400-57C	L-20	T-480-16	L-23		
SC-5	G-6	T-400-58C	L-20	T-480-17	L-23		
SC-6	G-6	T-400-59C	L-20	T-480-18	L-23		
SC-8	G-6	T-400-60C	L-20	T-480-2	L-23, L-27		
SFK-08	H-89	T-400-61C	L-20	T-480-3	L-23, L-30		
SFK-12	H-89	T-400-66	L-20	T-480-69	L-23		
SFK-16	H-89	T-400-70	L-20	T-480-P	L-23		
SFK-20	H-89	T-400-8	L-24	T-480-PSK	L-23		
SFK-24	H-89	T-400-80C	L-21	T-480-SFK	L-23		
SFK-32	H-89	T-400-81C	L-21	T-480-SP	L-23		
SFK62-12	H-89	T-400-82C	L-21	T-480-SPK	L-23		
SFK62-16	H-89	T-400-83C	L-21	T-480-TBK	L-23		
SFK62-20	H-89	T-400-90	L-24	T-481-110	L-23, L-28		
SFK62-24	H-89	T-400-B	L-24	T-482-2	L-23, L-29		
SFK62-32	H-89	T-400-BB	L-24	T-7002	J-142, L-37		
SFK62-8	H-89	T-400-G	L-22, L-24	T-7003	J-142, L-37		
SS-85	L-62	T-400-GT	L-31	T-7004	J-142, L-37		
SS-86	L-62	T-400-K1	L-24	T-7005	J-142, L-37		
SS-87	L-62	T-400-M	L-24	T-7006	J-142, L-37		
SS-88	L-63	T-400-PH	L-31	T-7008	J-142, L-37		
STE12-12	H-94	T-400-S	L-24	T-7010	J-142, L-37		
STE16-16	H-94	T-401-1BC	L-27, L-28	T-7012	J-142, L-37		
STE4-4	H-94	T-401-1S	L-27	T-7016	J-142, L-37		
STE4-5	H-94	T-401-SVF	L-27	T-7020	J-142, L-37		
STE6-6	H-94	T-402-2	L-29	T-7024	J-142, L-37		
STE8-8	H-94	T-403-2	L-27	T-7032	J-142		
T-101A	L-26	T-410-1M	L-22	T-71	L-36		
T-1042	L-24	T-410-22	L-16	T-75-11	L-24		
T-1047	L-24	T-420	L-10	T-75-12	L-24		
T-1047-1	L-24	T-420-001	L-11	T-75-14	L-24		
T-1060	L-24	T-420-001CSA	L-11	T-75-17	L-24		

Eaton
Hydraulics Group USA
14615 Lone Oak Road
Eden Prairie, MN 55344
USA
Tel: 952-937-9800
Fax: 952-294-7722
www.eaton.com/hydraulics

Eaton
Hydraulics Group Europe
Route de la Longeraie 7
1110 Morges
Switzerland
Tel: +41 (0) 21 811 4600
Fax: +41 (0) 21 811 4601

Eaton
Hydraulics Group Asia Pacific
Eaton Building
4th Floor, No.7 Lane280 Linhong Rd.
Changning District
Shanghai 200335
China
Tel: (+86 21) 5200 0099
Fax: (+86 21) 2230 7240