



Amflö

AIR HOSE, HOSE REELS & AIR ACCESSORIES

AIR ACCESSORIES

TRU-FLATE

Catalog # 90206

Contents

New Products.....	3
Air Hose Assemblies.....	4-9
Pneumatic Air Hose & Electrical Cord Reels.....	10-11
Plug & Coupler Features & Innovation.....	12-15
Plugs & Couplers.....	16-29
Inflator Gauges.....	30-31
Air Line Chucks.....	32-33
Blowguns.....	34-39
Hose Fittings.....	40-43
Air Line Hook-up Diagram.....	44-45
Tru-Flate Filters, Regulators and Lubricators.....	46-49
In-Line Air Tools.....	50-51
Amflo Filters, Regulators and Lubricators.....	52-55
Air Accessories.....	56-59
Hose Crimpers & Ferrules.....	60
Merchandisers/Displays.....	61-64
Parts Index.....	65-74

Amflo⁺ **TRU-FLATE[®]**

The Plews Advantage

- **Full Category Management.**
- **Constant pulse on the industry and participation in all major data collection resources.**
- **Complete, in-house marketing and creative team to ensure quick turn-around times.**
- **Ability to recognize and participate in promotional opportunities that drive an increase in revenue.**

**PLEWS &
EDELMAANN**



NEW PRODUCTS RELEASED

ULTRA AIR[®] HYBRID AIR HOSE

(see page 4 & 8)



**ENHANCED
COLOR**

HI FLO[®] CONVERSION KIT

(see page 9 & 27)



RECOIL AIR HOSE KIT

(see page 9 & 58)



INFLATOR GAUGE

(see page 31)



HI FLO[®] SWIVEL PLUG

(see page 27)



UNIVERSAL SWIVEL COUPLER

(see page 29)



IN-LINE REGULATOR

(see page 51)



AIR HOSE REPAIR KITS

(see page 41)



INFLATION NEEDLES

(see page 39)

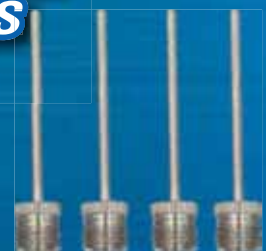

Ultra Air®

- Premium hybrid material
- High performance flexibility, even in extreme cold
- Lightweight enhanced maneuvering
- Lays flat, kink resistant under pressure
- Premium bend restrictors to extend hose life
- Temperature range: -40°F to +150°F
- Three year warranty

Ultra Air® Hybrid Air Hose

Part No.	Hose Diam.	Hose Length	Working Pressure	Hose Color	Fittings Size	Extras
572-25	1/4"	25'	300 PSI	Yellow	1/4" MNPT	Premium Bend Restrictors
572-50	1/4"	50'	300 PSI	Yellow	1/4" MNPT	Premium Bend Restrictors
572-100	1/4"	100'	300 PSI	Yellow	1/4" MNPT	Premium Bend Restrictors
575-25A	3/8"	25'	300 PSI	Yellow	1/4" MNPT	Premium Bend Restrictors
575-35A	3/8"	35'	300 PSI	Yellow	1/4" MNPT	Premium Bend Restrictors
575-50A	3/8"	50'	300 PSI	Yellow	1/4" MNPT	Premium Bend Restrictors
575-100A	3/8"	100'	300 PSI	Yellow	1/4" MNPT	Premium Bend Restrictors
573-25A	1/2"	25'	300 PSI	Yellow	3/8" MNPT	Premium Bend Restrictors
573-50A	1/2"	50'	300 PSI	Yellow	3/8" MNPT	Premium Bend Restrictors
573-100A	1/2"	100'	300 PSI	Yellow	3/8" MNPT	Premium Bend Restrictors



HOSE MATERIAL	LIGHT WEIGHT	COLD WEATHER FLEXIBILITY	RESISTS TWISTING	NON-MARRING
Hybrid				

Good Very Good Excellent



WARNING: KEEP OUT OF REACH OF CHILDREN. This product is designed for use on regulated compressed air lines or on air compressors where pressure does not exceed 300 PSI. Do not exceed the pressure limitation of the hose and/or air operated devices being used. Failure to follow these specifications and directions exactly may result in personal injury and/or property damage.

RUBBER AIR HOSE

Amflo

Rubber Air Hose

Amflo® Rubber Air Hose is ideal for rugged applications where hoses may be dragged over concrete or other rough surfaces. The rubber construction offers very good cold weather flexibility and coils easily for storage. It is ideal for garage, shop, industry, home and many other uses. Temperature Range: -20°F to +165°F. Three year warranty.

Part No.	Hose Diam.	Hose Length	Working Pressure	Hose Color	Fittings Size	Extras
512-25E	1/4"	25'	300 PSI	Red	1/4" MNPT	N/A
512-50E	1/4"	50'	300 PSI	Red	1/4" MNPT	N/A
552-25AE	3/8"	25'	300 PSI	Red	1/4" MNPT	Bend Restrictors
552-50AE	3/8"	50'	300 PSI	Red	1/4" MNPT	Bend Restrictors

HOSE MATERIAL	LIGHT WEIGHT	COLD WEATHER FLEXIBILITY	RESISTS TWISTING	NON-MARRING
Rubber	○	◐	●	○

○ Good ◐ Very Good ● Excellent

Heavy Duty Rubber Air Hose

Amflo Heavy Duty Rubber Hose is ideal for the most extreme applications where air hoses are needed. Its heavy duty construction is perfect when it must be dragged over concrete or rough surfaces. The heavy duty rubber offers very good cold weather flexibility and allows for easy coiling when finished. Sunlight and chemicals have little to no effect on this heavy duty hose making it perfect for garage, shop, industry, home and many other uses. Best of all, it's Made in the USA! Temperature Range: -40°F to +210°F. Three year warranty.

Part No.	Hose Diam.	Hose Length	Working Pressure	Hose Color	Fittings Size	Extras
556-50A	3/8"	50'	300 PSI	Black	1/4" MNPT	Premium Bend Restrictors

HOSE MATERIAL	LIGHT WEIGHT	COLD WEATHER FLEXIBILITY	RESISTS TWISTING	NON-MARRING
Heavy Duty Rubber	○	◐	●	○

○ Good ◐ Very Good ● Excellent



WARNING: KEEP OUT OF REACH OF CHILDREN. This product is designed for use on regulated compressed air lines or on air compressors where pressure does not exceed 300 PSI. Do not exceed the pressure limitation of the hose and/or air operated devices being used. Failure to follow these specifications and directions exactly may result in personal injury and/or property damage.

POLYURETHANE & PVC AIR HOSE

Amflö



Features Field Repairable Ends
Only on 14-50 & 14-100



Polyurethane Air Hose

The light weight of polyurethane hose makes it ideal for applications where dragging a heavy hose is an issue, like roofing. The smooth, non-marring finish also makes it ideal for indoor trim work where scratching surfaces could create damage. Maintains very good cold weather flexibility. Swivel end fittings reduce hose twist and heavy-duty molded bend restrictors reduce kinking and help increase the life of the hose. Temperature Range: -30°F to +150°F. Four year warranty.

Part No.	Hose Diam.	Hose Length	Working Pressure	Hose Color	Fittings Size	Extras
12-25E	1/4"	25'	300 PSI	Blue	1/4" MNPT	Swivel Fittings, Bend Restrictors
12-50E	1/4"	50'	300 PSI	Blue	1/4" MNPT	Swivel Fittings, Bend Restrictors
12-100E	1/4"	100'	300 PSI	Blue	1/4" MNPT	Swivel Fittings, Bend Restrictors
13-50AE	3/8"	50'	300 PSI	Blue	1/4" MNPT	Swivel Fittings, Bend Restrictors
13-100AE	3/8"	100'	300 PSI	Blue	1/4" MNPT	Swivel Fittings, Bend Restrictors
14-50	1/4"	50'	300 PSI	Blue	1/4" MNPT	Field Repairable End Fittings
14-100	1/4"	100'	300 PSI	Blue	1/4" MNPT	Field Repairable End Fittings

HOSE MATERIAL	LIGHT WEIGHT	COLD WEATHER FLEXIBILITY	RESISTS TWISTING	NON-MARRING
Poly	●	●	●	●

○ Good ● Very Good ● Excellent

PVC Air Hose

Amflö® PVC Air Hose is ideal for general purpose applications. It features a lightweight, flexible, kink-resistant design with bend restrictors. Its bright florescent colors reduce chances of tripping while on a job site. Temperature Range: +20°F to +145°F. Two year warranty.

Part No.	Hose Diam.	Hose Length	Working Pressure	Hose Color	Fittings Size	Extras
576-25A	3/8"	25'	300 PSI	Orange	1/4" MNPT	Bend Restrictors
576-50A	3/8"	50'	300 PSI	Orange	1/4" MNPT	Bend Restrictors
576-100A	3/8"	100'	300 PSI	Orange	1/4" MNPT	Bend Restrictors
554-50A	3/8"	50'	300 PSI	Blue	1/4" MNPT	Bend Restrictors
554-100A	3/8"	100'	300 PSI	Blue	1/4" MNPT	Bend Restrictors

HOSE MATERIAL	LIGHT WEIGHT	COLD WEATHER FLEXIBILITY	RESISTS TWISTING	NON-MARRING
PVC PVC	●	○	○	●

○ Good ● Very Good ● Excellent

WARNING: KEEP OUT OF REACH OF CHILDREN. This product is designed for use on regulated compressed air lines or on air compressors where pressure does not exceed 300 PSI. Do not exceed the pressure limitation of the hose and/or air operated devices being used. Failure to follow these specifications and directions exactly may result in personal injury and/or property damage.

RECOIL AIR HOSES

Amflo

Nylon Recoil Air Hose

Nylon Recoil Hose retains its self-coiling properties and stores itself when finished. Can be used with all air-powered equipment on the job site and in garages, plants and service stations. The swivel end fittings reduce hose twist. Temperature Range: +32°F to +120°F. One year warranty.

Part No.	Hose Diam.	Hose Length	Working Pressure	Hose Color	Fittings Size	Extras
4-12	1/4"	12'	200 PSI	Yellow	1/4" MNPT	Swivel Fittings
4-25E-RET	1/4"	25'	200 PSI	Yellow	1/4" MNPT	Swivel Fittings
4-50E-RET	1/4"	50'	200 PSI	Yellow	1/4" MNPT	Swivel Fittings
6-25	3/8"	25'	200 PSI	Yellow	3/8" MNPT	Swivel Fittings

Polyurethane Recoil Air Hose

Polyurethane Recoil Hose retains its self-coiling properties and stores itself when finished. Can be used with all air-powered equipment on the job site and in garages, plants and service stations. The swivel end fittings reduce hose twist. Bend restrictors reduce kinking and increase the life of the hose. The soft polyurethane finish is less likely to scratch surfaces. Temperature Range: -30°F to +150°F. Three year warranty.

Part No.	Hose Diam.	Hose Length	Working Pressure	Hose Color	Fittings Size	Extras
24-25E-RET	1/4"	25'	120 PSI	Blue	1/4" MNPT	Swivel Fittings, Bend Restrictors
24-50E-RET	1/4"	50'	120 PSI	Blue	1/4" MNPT	Swivel Fittings, Bend Restrictors



WARNING: KEEP OUT OF REACH OF CHILDREN. This product is designed for use on regulated compressed air lines or on air compressors where pressure does not exceed 300 PSI. Do not exceed the pressure limitation of the hose and/or air operated devices being used. Failure to follow these specifications and directions exactly may result in personal injury and/or property damage.

BULK & LEAD-IN AIR HOSES

Amflo



Bulk Air Hose

Part No.	Hose Diam.	Hose Length	Working Pressure	Hose Color	Fittings Size	Extras
Rubber Signal Bell Tubing						
494-100	3/8"	100'	200 PSI	Black	None	N/A
494-500	3/8"	500'	200 PSI	Black	None	N/A
Rubber Air Hose						
514-500	3/8"	500'	300 PSI	Red	None	N/A

Lead-In Air Hose

Lead-In Air Hoses absorb the vibrations and pulsations from air compressors and air impact tools, providing longer life for the balance of the pneumatic system. Ball swivels allow for greater flexibility and bend restrictors prevent the hose from weakening and breaking after frequent sharp bends.

Part No.	Hose Diam.	Hose Length	Working Pressure	Hose Color	Fittings Size	Extras
PVC Lead-In Hose						
25-24-RET	1/4"	24"	300 PSI	Blue	1/4" MNPT x 1/4" FNPT	Swivel End
Rubber Lead-In Hose						
25L-24BD	1/4"	24"	300 PSI	Red	1/4" MNPT x 1/4" FNPT	Ball Swivel, Bend Restrict.
25L-60BD	1/4"	60"	300 PSI	Red	1/4" MNPT x 1/4" FNPT	Ball Swivel, Bend Restrict.
37L-30B-RET	3/8"	30"	300 PSI	Red	1/4" MNPT x 1/4" FNPT	Ball Swivel, Bend Restrict.
Ultra Air® Hybrid Lead-In Hose						
57L-30B-RET	3/8"	30"	300 PSI	Yellow	1/4" MNPT x 1/4" FNPT	Ball Swivel, Bend Restrict.
57L-48B-RET	3/8"	48"	300 PSI	Yellow	1/4" MNPT x 1/4" FNPT	Ball Swivel, Bend Restrict.
57L-72B-RET	3/8"	72"	300 PSI	Yellow	1/4" MNPT x 1/4" FNPT	Ball Swivel, Bend Restrict.

WARNING: KEEP OUT OF REACH OF CHILDREN. This product is designed for use on regulated compressed air lines or on air compressors where pressure does not exceed 300 PSI. Do not exceed the pressure limitation of the hose and/or air operated devices being used. Failure to follow these specifications and directions exactly may result in personal injury and/or property damage.

AIR KITS / BONUS PACKS

Amflo

Air Hose Kits / Bonus Packs

Part No.	Hose Diam.	Hose Length	Working Pressure	Hose Material	Hose Color	Fittings Size	Extras
10-11K	1/4"	11 1/2'	N/A	Type A Nylon	Gray	Compression Tee x 1/4" MNPT	Compression Tee to splice into Air Seat Supply Line, Blowgun with Two Nozzles
41-253	1/4"	23'	120 PSI	Poly	Blue	1/4" MNPT	14-Piece Kit: Safety Blowgun, 5 Tips, 1/4" Coupler, Three 1/4" Plugs, Chuck, Two Couplings, Tire Gauge
574-50GH	3/8"	50'	300 PSI	PVC	Red	1/4" MNPT x Glad Hand	Universal Glad-Hand Kit Dual-foot Air Chuck
575-50AGH	3/8"	50'	300 PSI	Hybrid	Yellow	1/4" MNPT x Glad Hand	Universal Glad-Hand Kit, Dual-foot Air Chuck, Premium Bend Restrictors
14-50K	1/4"	50'	300 PSI	Poly	Blue	1/4" MNPT	9-Piece Kit: Safety Blowgun, 5 Tips, 1/4" Coupler, Two 1/4" Plugs
576-50AK	3/8"	50'	300 PSI	PVC	Orange	1/4" MNPT	9-Piece Kit: Safety Blowgun, 5 Tips, 1/4" Coupler, Two 1/4" Plugs
552-50AK (24 pc Display)	3/8"	50'	300 PSI	Rubber	Red	1/4" MNPT	9-Piece Kit: Safety Blowgun, 5 Tips, 1/4" Coupler, Two 1/4" Plugs
552-50AK-5	3/8"	50'	300 PSI	Rubber	Red	1/4" MNPT	9-Piece Kit: Safety Blowgun, 5 Tips, 1/4" Coupler, Two 1/4" Plugs
580-50ACK	3/8"	50'	300 PSI	Hybrid	Gray	1/4" MNPT	5-Piece Kit: 2 HI FLO Couplers, 3 HI FLO Plugs



10-11K



41-253



574-50GH



575-50AGH



14-50K



576-50AK



552-50AK



580-50ACK

WARNING: KEEP OUT OF REACH OF CHILDREN. This product is designed for use on regulated compressed air lines or on air compressors where pressure does not exceed 300 PSI. Do not exceed the pressure limitation of the hose and/or air operated devices being used. Failure to follow these specifications and directions exactly may result in personal injury and/or property damage.

AUTOMATIC REELS

Amflo®



588HR-RET



538HR-RET
541HR-RET
543HR-RET



546HR-RET



507HR-RET
508HR-RET
518HR-RET

Automatic Enclosed Air Hose Reels

From DIYers to heavy-duty professionals, the Amflo® brand of automatic enclosed air hose reels has something for everyone. All reels feature impact resistant housing, guided automatic hose rewind system and a 180° steel swivel mounting bracket. The ability to be mounted vertically or horizontally allows them to fit any workspace configuration. Give consumers what they need with our Automatic Enclosed Air Hose Reels.

Part No.	Hose Diam.	Hose Length	Working Pressure	Hose Color	Fittings Size	Extras
Enclosed Ultra Air® Hybrid Air Hose Reel						

588HR-RET	3/8"	50'	300 PSI	Yellow	1/4" MNPT	Ratchet Brake, Bend Restrictors
-----------	------	-----	---------	--------	-----------	---------------------------------

Enclosed Ultra PRO® Hybrid Air Hose Reels						
--	--	--	--	--	--	--

Additional features for 538HR-RET, 541HR-RET, 543HR-RET, and 546HR-RET:

- Stop anywhere braking system for added convenience.
- Slow rewind spring helps retract air hose at a slower rate than most reels.
- 546HR-RET features the above, in addition to a carrying handle and quick disconnect bracket for maximum portability.

541HR-RET	3/8"	33'	300 PSI	Yellow	1/4" MNPT	Bend Restrictors
-----------	------	-----	---------	--------	-----------	------------------

543HR-RET	3/8"	50'	300 PSI	Yellow	1/4" MNPT	Bend Restrictors
-----------	------	-----	---------	--------	-----------	------------------

546HR-RET	3/8"	65'	300 PSI	Yellow	1/4" MNPT	Bend Restrictors
-----------	------	-----	---------	--------	-----------	------------------

538HR-RET	1/2"	50'	300 PSI	Yellow	3/8" MNPT	Bend Restrictors
-----------	------	-----	---------	--------	-----------	------------------

Automatic Open Face Air Hose Steel Reels

Amflo open face hose reels have an all steel construction for industrial versatility. They feature a spring-wound auto-rewind mechanism and a locking ratchet brake. Can be mounted vertically or horizontally. Guide arm is adjustable to dispense hose at various angles. Ultra PRO open face reels come with robust bend restrictors for extended hose life. These open face hose reels are perfect for your heavy duty and industrial consumers.

Part No.	Hose Diam.	Hose Length	Working Pressure	Hose Color	Fittings Size	Extras
Open Face Ultra PRO® Hybrid Air Hose Reels						

507HR-RET	3/8"	25'	300 PSI	Yellow	1/4" MNPT	Bend Restrictors
-----------	------	-----	---------	--------	-----------	------------------

508HR-RET	3/8"	50'	300 PSI	Yellow	1/4" MNPT	Bend Restrictors
-----------	------	-----	---------	--------	-----------	------------------

518HR-RET	1/2"	50'	300 PSI	Yellow	3/8" MNPT	Bend Restrictors
-----------	------	-----	---------	--------	-----------	------------------

AUTOMATIC / MANUAL REELS

Amflo

2n1 Automatic Open Face Steel Reel

The Amflo® 2n1 steel reel combines an air hose and an electrical cord operating as two independent self-retracting assemblies, perfect for jobs that require pneumatic and electrical power feeds. The all steel construction is great for industrial versatility and can be mounted vertically or horizontally. Features spring-wound auto rewind and locking ratchet brake. Guide arm is adjustable to dispense hose at various angles. Equipped with built-in resettable circuit breaker and lighted triple socket for easy power recognition and multi-tool use capabilities. Perfect for any garage, professional or DIY.

Part No.	Hose Diam.	Cord Gauge	Hose/Cord Length	Hose/Cord Color	Fittings Size	Extras
Ultra PRO® 2n1 Extension Cord & Hybrid Air Hose Reel						

603-2N1-RET	3/8"	14 AWG	25' Hose / 50' Cord	Yellow	1/4" MNPT	3 Plug Lighted Socket, Bend Restrictors
--------------------	------	--------	---------------------	--------	-----------	---

Automatic Electric Cord Reels

Amflo enclosed cord reels feature high impact enclosed housing and 180° steel swivel mounting bracket. With their locking ratchet brake and automatic cord rewind system these cord reels are perfect for any consumer. Equipped with built-in resettable circuit breaker and lighted triple socket for easy power recognition and multi-tool use capabilities. Can be mounted vertically or horizontally to fit any workspace configuration.

Part No.	Cord Length	Cord Gauge	Cord Color	Extras
ELECTRAREEL® Enclosed Cord Reels				

590CR-RET	40'	12AWG	Yellow	3 Plug Lighted Socket
591CR-RET	50'	14AWG	Yellow	3 Plug Lighted Socket

Manual Air Hose Reels

Amflo manual hose reels feature all steel construction, comfortable handle grips and a spring tension brake to prevent accidental unwinding. Standard manual reels can be mounted horizontally or vertically and are available in three configurations – assembled with hose and assembled or unassembled without hose to take up less space on the retail shelf. The dual output manual reel sits on the ground or can be conveniently nailed to the roof for maximum maneuverability. It is perfect for the construction site as it comes with 75' of lightweight polyurethane air hose. Manual hose reels are perfect for the economical shopper in the market for an air hose reel.

Part No.	Hose Diam.	Hose Length	Working Pressure	Hose Color	Fittings Size	Extras
Manual Reel - Preassembled						

545HR-RET	3/8"	75'	200 PSI	Gold	1/4" NPT	Dual Output Fittings, Poly Hose
------------------	------	-----	---------	------	----------	---------------------------------

Manual Reel - Unassembled

503HR-RET	N/A	N/A	250 PSI	N/A	1/4" NPT	N/A
------------------	-----	-----	---------	-----	----------	-----

603-2N1-RET



590CR-RET
591CR-RET



545HR-RET



503HR-RET



INNOVATIVE PACKAGE DESIGN



Tru-Flate® Packaging

- Tru-Flate offers innovative, patented die-cut packaging to aid in the selection process.
 - Plug outline template built into card to compare profiles
 - Reduces confusion for end-user
 - Patent number 9169053
- Tire repair and air accessories packages are coordinated to give a strong, unmistakable family appearance at retail.



Coupler / Plug Key Ring

These sturdy key rings are among the finest available. Similar to 1/8" pneumatic coupler and plug sets with steel construction and heavy nickel plating. Will provide years of reliable service and security.

- 900-10 10/box.
- 900 Bulk.100/box.



900

Coupler / Plug Identifier

Makes coupler and plug sales easy. Gives counter men a "surefire" way to quickly and accurately identify the proper 1/4" series plug for their coupler. Metal bar has each of four basic design plugs permanently fastened to the bar. Color-coded plugs on bar match correct coupler and plug package. Each design name is stamped in bar. Complete with handy hanger strap.

- 96-901 Coupler Test Bar. 1/bag.
- 96-902 Plug Test Bar. 1/bag.



96-901

96-902

How to Identify Interchange Designs

Interchangeability of pneumatic couplings is determined by PLUG DESIGN. Learn to identify the basic plug types, and coupler and plug interchange will become easy. There are several different designs currently used in the market with I/M being the most popular at about 70% of couplers and plugs sold.

Automotive Tru-Flate Design 12/13-100 Series

This design is easily recognized because it has the shortest plug pilot in the industry; however, it has the widest metal section between the ball groove and the pilot. In addition, the sealing surface on the end of the plug is wider than other "interchange" designs. This design provides better sealing characteristics and longer seal life.

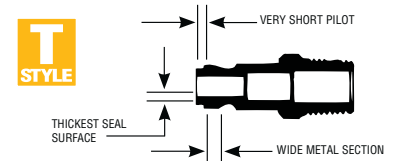

Industrial Milton Design 12/13-200 Series

This design has been adopted by many coupler manufacturers, including Milton, Hansen, ARO, Lincoln and Schrader. It will work with either "sleeve" type or "push" type couplers. There are several different designs currently used in the market with I/M being the most popular at about 70% of couplers and plugs sold.

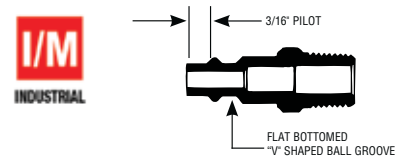

Automotive ARO Design 12/13-300 Series

This design is characteristic of the ARO 210 series, and requires a coupler of proper matching design. Although similar in appearance to the "Industrial/Milton Interchange" design, it can be easily distinguished because its pilot is 1/8" longer and its ball groove is nearly round.

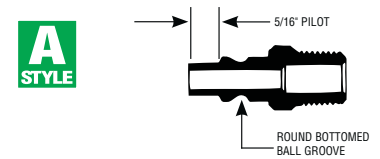

Lincoln Design 12/13-400 Series

The "Lincoln long-stem" design is the most easily identified design. The long 3/4" pilot is so distinctive it cannot be confused with other designs. It will only mate with couplers of matching design and size.

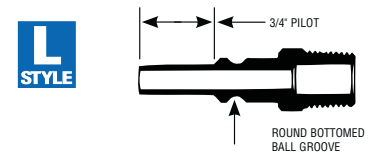

HI FLO Design 12/13-900 Series

The HI FLO design has a similar profile to the I/M design, but has a much wider opening to allow almost three times the air flow. HI FLO plugs will not work with any other coupler design, but the HI FLO couplers will work with a small leak with some of the standard coupler designs if the need should arise.

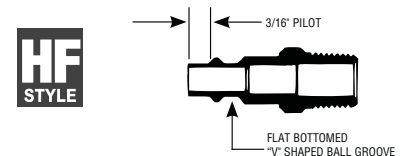

Other Designs

GRACO

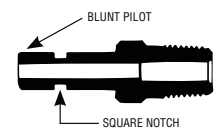

DIAMOND-U

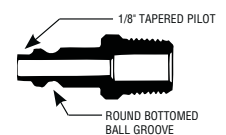

SCHRADER STANDARD

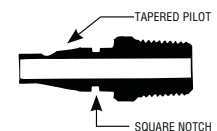

How to Interchange Couplers and Plugs

Design Selection

Similar name designs, whether manufactured by Amflo, Tru-Flate or a competitor, are interchangeable. NOTE: Designs are not interchangeable with other designs.

Size Selection

There are three BODY SERIES sizes – Standard 1/4" and Heavy Duty 3/8" and 1/2". To interchange, the coupler and plug must have the same body size.

CFM FLOW REQUIREMENTS

TRU-FLATE® Amflö®

CHOOSE THE RIGHT COUPLER & PLUG FOR YOUR APPLICATION

Standard Couplers & Plugs

- Steel is suitable for indoor use or in dry conditions
- Brass is suitable for indoor or outdoor use
 - Resists rust & corrosion in damp conditions

Best Used For:

- DIY / Homeowner
 - Shop inflation
 - Air guns for cleanup of floors / workbenches



Tru-Match® Couplers & Plugs

- Aluminum is suitable for indoor or outdoor use
- Perfect for consumers who need to keep air lines separated

Best Used For:

- DIY / Homeowner / Semi-Professional
 - Air tools & nailers
 - Paint guns & sanders



HI FLO® Couplers & Plugs

- Aluminum is suitable for indoor or outdoor use
- Perfect for consumers who require a higher amount of air flow

Best Used For:

- Professionals / Shops
 - Air tools & nailers
 - Air guns
 - Paint & body tools



* all CFM flow values were tested using 90 PSI

Plews Accidental Disconnect Protection

All Amflo and Tru-Flate couplers come with a sleeve guard that reduces the potential for accidental disconnect caused by snags or tight work spaces. It also has the added benefit of protecting the sleeve under the toughest working conditions.



HI FLO® & TRU-MATCH® AIR FITTINGS

TRU-FLATE® Amflo®

TRU-FLATE®

HI FLO® COUPLERS & PLUGS



- Increased flow ensures your tools will provide maximum torque and optimal performance.
- Push-to-connect design for quick easy connections.
- Durable lightweight T6 aluminum construction.
- Corrosion resistant with stainless steel ball bearings.

Let Your Customers Unleash The Full Power Of Their Air Tools!

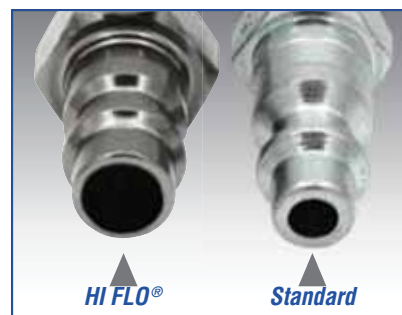

Allow consumers to replace their fittings, not their hose.

TRU-FLATE®

TRU-MATCH® COUPLERS & PLUGS

- Push-to-connect design for quick easy connections.
- Couplers allow increased air flow compared to 25 CFM standard couplers.
- Durable lightweight T6 aluminum construction.
- Color-code lubricated vs dry lines to prevent cross contamination.



PLUGS & COUPLERS

TRU-FLATE® Amflö®



I/M Industrial Design

Adopted by most coupler manufacturers, this plug design is considered the industrial standard. It can be identified by the 3/16" pilot and flat bottom V-shaped ball groove. Conforms to ANSI (NFPA) T3.20.14-1990 dimensions. Couplers are available in both standard and push-to-connect style sleeve.

Thread	NPT	Style	Metal	Tru-Flate	Quantity	Amflo	Quantity
1/4" Body Series – Plugs							
Male	1/4"	A	Steel	–	–	CP21	10/box
Male	1/4"	A	Steel	–	–	CP21-100	100/box
Male	1/4"	A	Steel	12-225	10/master*	–	–
Male	1/4"	A	Steel	12-225-2 ²	10/master*	–	–
Swivel M	1/4"	I	Steel	12-223	10/master*	–	–
Male	1/4"	A	Brass	–	–	CP21B	10/box
Male	1/4"	A	Brass	–	–	CP21B-100	100/box
Male	1/4"	A1	Aluminum	12-224R	10/box	–	–
Male	3/8"	A	Steel	–	–	CP21-03	10/box
Male	3/8"	A	Steel	12-227	10/master*	–	–
Female	1/4"	B	Steel	–	–	CP20	10/box
Female	1/4"	B	Steel	–	–	CP20-100	100/box
Female	1/4"	B	Steel	12-235	10/master*	–	–
Female	1/4"	B	Steel	12-235-2 ²	10/master*	–	–
Swivel F	1/4"	J	Steel	12-233	10/master*	–	–
Female	1/4"	B	Brass	–	–	CP20B	10/box
Female	1/4"	B	Brass	–	–	CP20B-100	100/box
Female	1/4"	B1	Aluminum	12-234R	10/box	–	–
Female	3/8"	B	Steel	–	–	CP20-23	10/box
Female	3/8"	B	Steel	12-237	10/master*	–	–
Female	.307-32"	B	Steel	–	–	CP22	10/box
Hose Barb	1/4"	C	Steel	–	–	CP21-42	10/box
Hose Barb	1/4"	C	Steel	–	–	CP21-42-100	100/box
Hose Barb	3/8"	C	Steel	–	–	CP21-44	10/box
Hose Barb	3/8"	C	Steel	–	–	CP21-44-100	100/box
Lock-On	1/4"	K	Steel	–	–	CP21-42L	10/box
Lock-On	3/8"	K	Steel	–	–	CP21-44L	10/box

* - Carded display package

² - Two pack on a carded display package

PLUGS & COUPLERS

TRU-FLATE® Amflo®



I/M Industrial Design

Thread	NPT	Style	Metal	Tru-Flate	Quantity	Amflo	Quantity
1/4" Body Series – Couplers							
Male	1/4"	D	Steel	–	–	C21	10/box
Male	1/4"	D	Steel	–	–	C21-100	100/box
Male	1/4"	D	Brass	–	–	C21B	10/box
Male	1/4"	D	Brass	–	–	C21B-100	100/box
Male	1/4"	D	Brass	13-225	10/master*	–	–
Male	1/4"	D1	Aluminum	13-224R	10/box	–	–
Male	3/8"	D	Steel	–	–	C21-03	10/box
Male	3/8"	D	Brass	–	–	C21-03B	10/box
Male	3/8"	D	Brass	13-227	10/master*	–	–
Male	3/8"	D	Brass	–	–	C21-03B-100	100/box
Female	1/4"	E	Steel	–	–	C20	10/box
Female	1/4"	E	Steel	–	–	C20-100	100/box
Female	1/4"	E	Brass	–	–	C20B	10/box
Female	1/4"	E	Brass	–	–	C20B-100	100/box
Female	1/4"	E	Brass	13-235	10/master*	–	–
Female	1/4"	E1	Aluminum	13-234R	10/box	–	–
Female	3/8"	E	Steel	–	–	C20-23	10/box
Female	3/8"	E	Steel	–	–	C20-23-100	100/box
Female	3/8"	E	Brass	–	–	C20-23B	10/box
Female	3/8"	E	Brass	13-237	10/master*	–	–
Hose Barb	1/4"	F	Steel	–	–	C20-42	10/box
Hose Barb	1/4"	F	Steel	–	–	C20-42-100	100/box
Hose Barb	1/4"	F	Brass	–	–	C20-42B	10/box
Hose Barb	3/8"	F	Steel	–	–	C20-44	10/box
Hose Barb	3/8"	F	Steel	–	–	C20-44-100	100/box
Hose Barb	3/8"	F	Brass	–	–	C20-44B	10/box
Lock-On	1/4"	L	Steel	–	–	C20-42L	10/box
Lock-On	1/4"	L	Brass	–	–	C20-42LBP-100	100/box
Lock-On	3/8"	L	Steel	–	–	C20-44L	10/box
Lock-On	3/8"	L	Brass	–	–	C20-44LBP-100	100/box

*Carded display package



WARNING: Due to their large size, these couplers should not be connected or disconnected if the line pressure exceeds 40 PSI.
WARNING: Couplers and plugs are intended for use on compressed air lines only. All have maximum rated working pressure of 300 PSI.

PLUGS & COUPLERS

TRU-FLATE® Amflo®



I/M Industrial Design



13-203



13-209R

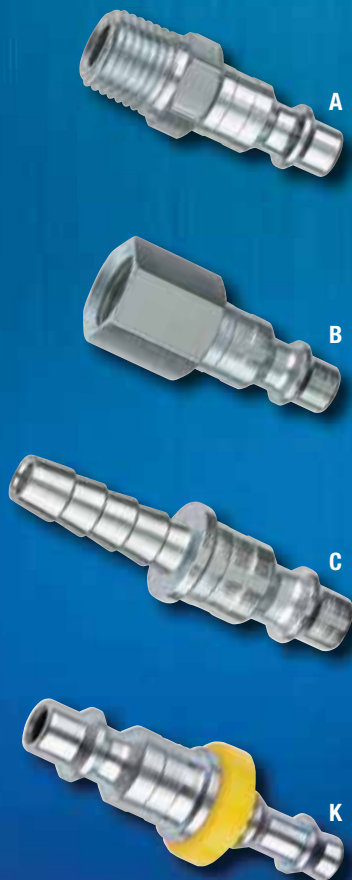

Thread	NPT	Style	Metal	Tru-Flate	Quantity	Amflo	Quantity
--------	-----	-------	-------	-----------	----------	-------	----------

Plug/Coupler Sets / Kits							
One each of 12-225 and 13-235				13-201	10/master*	-	-
One each of 12-225, 12-235, 13-235 and 21-505				13-203	5/master*	-	-
One each 13-234R, 12-224R, and 12-234R				13-207R	10/master*	-	-
One 13-224R, One 13-234R, Two 12-234R, and Three 12-224R				13-209R	10/master*	-	-
Two each 13-224R, Two 13-234R, Four 12-234R, and Six 12-224R				13-211R	10/master*	-	-

Thread	NPT	Style	Metal	Tru-Flate	Quantity	Amflo	Quantity
--------	-----	-------	-------	-----------	----------	-------	----------

3/8" Body Series – Plugs							
Male	1/4"	A	Steel	12-523	5/master*	-	-
Male	1/4"	A	Steel	-	-	CP25-02	10/box
Male	1/4"	A	Steel	-	-	CP25-02-100	100/box
Male	3/8"	A	Steel	-	-	CP25	10/box
Male	3/8"	A	Steel	-	-	CP25-50	50/box
Male	3/8"	A	Steel	12-527	5/master*	-	-
Male	1/2"	A	Steel	-	-	CP25-04	10/box
Female	1/4"	B	Steel	-	-	CP26-22	10/box
Female	3/8"	B	Steel	-	-	CP26	10/box
Female	3/8"	B	Steel	12-537	5/master*	-	-
Female	1/2"	B	Steel	-	-	CP26-24	10/box
Hose Barb	3/8"	C	Steel	-	-	CP25-44	10/box
Hose Barb	1/2"	C	Steel	-	-	CP25-45	10/box
Lock-On	3/8"	K	Steel	-	-	CP25-44L	10/box

*Carded display package

PLUGS & COUPLERS

TRU-FLATE® Amflo®



I/M Industrial Design

Thread	NPT	Style	Metal	Tru-Flate	Quantity	Amflo	Quantity
3/8" Body Series – Couplers							
Male	1/4"	D	Steel	–	–	C25-02	10/box
Male	3/8"	D	Steel	–	–	C25	10/box
Male	3/8"	D	Steel	–	–	C25-50	50/box
Male	3/8"	D	Steel	13-527	5/master*	–	–
Female	1/4"	E	Steel	–	–	C26-22	10/box
Female	3/8"	E	Steel	–	–	C26	10/box
Female	3/8"	E	Steel	–	–	C26-50	50/box
Female	3/8"	E	Steel	13-537	5/master*	–	–
Female	1/2"	E	Steel	–	–	C26-24	10/box
Hose Barb	3/8"	F	Steel	–	–	C26-44	10/box
Hose Barb	1/2"	F	Steel	–	–	C26-45	10/box
Lock-On	3/8"	L	Steel	–	–	C26-44L	10/box

1/2" Body Series – Plugs							
Male	3/8"	A	Steel	–	–	CP17-03	10/box
Male	1/2"	A	Steel	–	–	CP17	10/box
Female	3/8"	B	Steel	–	–	CP18-23	10/box
Female	1/2"	B	Steel	–	–	CP18	10/box
Hose Barb	1/2"	C	Steel	–	–	CP17-45	10/box

1/2" Body Series – Couplers							
Male	3/8"	D	Steel	–	–	C9-03	10/box
Male	1/2"	D	Steel	–	–	C9	10/box
Male	1/2"	D	Steel	–	–	C9-50	50/box
Male	1/2"	D	Steel	13-705	5/master*	–	–
Female	3/8"	E	Steel	–	–	C10-23	10/box
Female	1/2"	E	Steel	–	–	C10	10/box
Female	1/2"	E	Steel	–	–	C10-50	50/box
Female	1/2"	E	Steel	13-713	5/master*	–	–
Hose Barb	1/2"	F	Steel	–	–	C10-45	10/box

*Carded display package



WARNING: Due to their large size, these couplers should not be connected or disconnected if the line pressure exceeds 40 PSI.
WARNING: Couplers and plugs are intended for use on compressed air lines only. All have maximum rated working pressure of 300 PSI.

PLUGS & COUPLERS

TRU-FLATE® Amflö®



T-Style® Design

The Tru-Flate Design Plug is recognized by the extremely short pilot; however, it has the widest metal section between the groove and the pilot. The sealing surface on the end of the plug is wider than other interchanges, resulting in better sealing and longer seal life. The Tru-Flate Design Coupler utilizes the tubular valve which supports the seal and allows more air flow at lower pressure drops than most competitive couplers. Couplers are available in both standard and push-to-connect style sleeve.

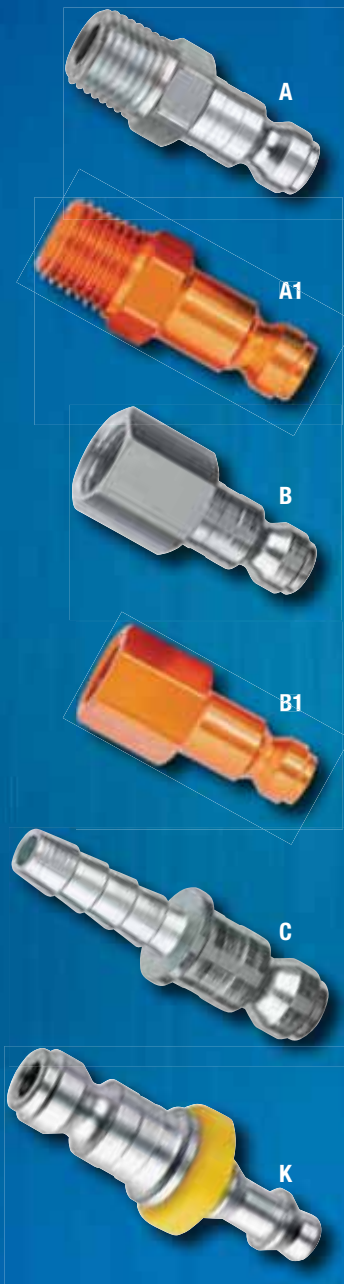

Thread	NPT	Style	Metal	Tru-Flate	Quantity	Amflo	Quantity
1/4" Body Series – Plugs							
Male	1/4"	A	Steel	–	–	CP1	10/box
Male	1/4"	A	Steel	–	–	CP1-100	100/box
Male	1/4"	A	Steel	12-125	10/master*	–	–
Male	1/4"	A	Steel	12-125-2 ²	10/master*	–	–
Male	1/4"	A	Brass	–	–	CP1B	10/box
Male	1/4"	A1	Aluminum	12-124B	10/box	–	–
Male	3/8"	A	Steel	–	–	CP1-03	10/box
Male	.307-32"	A	Steel	–	–	CP1-302	10/box
Female	1/4"	B	Steel	–	–	CP2	10/box
Female	1/4"	B	Steel	–	–	CP2-100	100/box
Female	1/4"	B	Steel	12-135	10/master*	–	–
Female	1/4"	B	Steel	12-135-2 ²	10/master*	–	–
Female	1/4"	B	Brass	–	–	CP2B	10/box
Female	1/4"	B1	Aluminum	12-134B	10/box	–	–
Female	3/8"	B	Steel	–	–	CP2-23	10/box
Hose Barb	1/4"	C	Steel	–	–	CP1-42	10/box
Hose Barb	3/8"	C	Steel	–	–	CP1-44	10/box
Lock-On	1/4"	K	Steel	–	–	CP1-42L	10/box
Lock-On	3/8"	K	Steel	–	–	CP1-44L	10/box

* - Carded display package

² - Two pack on a carded display package

PLUGS & COUPLERS

TRU-FLATE® Amflo®



T-Style® Design

Thread	NPT	Style	Metal	Tru-Flate	Quantity	Amflo	Quantity
1/4" Body Series – Couplers							
Male	1/4"	D	Brass	13-125	10/master*	–	–
Male	1/4"	D	Brass	–	–	C1B-100	100/box
Male	1/4"	D	Steel	–	–	C1	10/box
Male	1/4"	D	Steel	–	–	C1-100	100/box
Male	1/4"	D1	Aluminum	13-124B	10/box	–	–
Male	3/8"	D	Steel	–	–	C1-03	100/box
Female	1/4"	E	Brass	–	–	C2B	10/box
Female	1/4"	E	Brass	–	–	C2B-100	100/box
Female	1/4"	E	Brass	13-135	10/master*	–	–
Female	1/4"	E	Steel	–	–	C2	10/box
Female	1/4"	E	Steel	–	–	C2-100	100/box
Female	1/4"	E1	Aluminum	13-134B	10/box	–	–
Female	3/8"	E	Steel	–	–	C2-23	10/box
Hose Barb	1/4"	F	Steel	–	–	C2-42	10/box
Hose Barb	3/8"	F	Steel	–	–	C2-44	10/box
Lock-On	1/4"	L	Steel	–	–	C2-42L	10/box
Lock-On	3/8"	L	Steel	–	–	C2-44L	10/box
Plug/Coupler Set							
One each 13-135 and 12-125				13-101	10/master*	–	–
One each 13-134B, 12-124B, and 12-134B				13-107B	10/master*	–	–
One 13-124B, One 13-134B, Two 12-134B, and Three 12-124B				13-109B	10/master*	–	–
Two each 13-124B, Two 13-134B, Four 12-134B, and Six 12-124B				13-111B	10/master*	–	–

* - Carded display package



13-109B

WARNING: Due to their large size, these couplers should not be connected or disconnected if the line pressure exceeds 40 PSI.
WARNING: Couplers and plugs are intended for use on compressed air lines only. All have maximum rated working pressure of 300 PSI.



D



D1

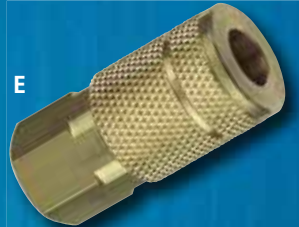

E



E1

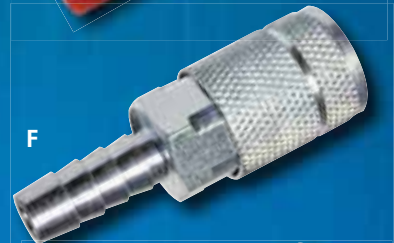

F



L

PLUGS & COUPLERS

TRU-FLATE® Amflo®



T-Style® Design

Thread	NPT	Style	Metal	Tru-Flate	Quantity	Amflo	Quantity
3/8" Body Series – Plugs							
Male	1/4"	A	Steel	–	–	CP7	10/box
Male	1/4"	A	Steel	–	–	CP7-50	50/box
Male	1/4"	A	Steel	12-603	10/master*	–	–
Male	1/4"	A	Steel	12-603-2 ²	10/master*	–	–
Male	3/8"	A	Steel	–	–	CP5	10/box
Male	3/8"	A	Steel	–	–	CP5-50	50/box
Male	3/8"	A	Steel	12-605	10/master*	–	–
Male	1/2"	A	Steel	–	–	CP5-04	10/box
Female	1/4"	B	Steel	–	–	CP8	10/box
Female	1/4"	B	Steel	12-611	10/master*	–	–
Female	1/4"	B	Steel	–	–	CP8-50	50/box
Female	3/8"	B	Steel	–	–	CP6	10/box
Female	3/8"	B	Steel	12-613	10/master*	–	–
Female	1/2"	B	Steel	–	–	CP6-24	10/box
Hose Barb	3/8"	C	Steel	–	–	CP5-44	10/box
Lock-On	3/8"	K	Steel	–	–	CP5-44L	10/box
3/8" Body Series – Couplers							
Male	1/4"	D	Steel	–	–	C7	10/box
Male	1/4"	D	Steel	–	–	C7-50	50/box
Male	1/4"	D	Steel	13-603	5/master*	–	–
Male	3/8"	D	Steel	–	–	C5	10/box
Male	3/8"	D	Steel	13-605	5/master*	–	–
Male	3/8"	D	Steel	–	–	C5-50	50/box
Male	1/2"	D	Steel	–	–	C5-04	10/box
Female	1/4"	E	Steel	–	–	C8	10/box
Female	1/4"	E	Steel	13-611	5/master*	–	–
Female	1/4"	E	Steel	–	–	C8-50	50/box
Female	3/8"	E	Steel	–	–	C6	10/box
Female	3/8"	E	Steel	13-613	5/master*	–	–
Female	3/8"	E	Steel	–	–	C6-50	50/box
Female	1/2"	E	Steel	–	–	C6-24	10/box
Hose Barb	3/8"	F	Steel	–	–	C6-44	10/box
Hose Barb	1/2"	F	Steel	–	–	C6-45	10/box

* - Carded display package

² - Two pack on a carded display package



PLUGS & COUPLERS

TRU-FLATE® Amflo®



T-Style® Design

Thread	NPT	Style	Metal	Tru-Flate	Quantity	Amflo	Quantity
1/2" Body Series – Plugs							
Male	3/8"	A	Steel	–	–	CP9-03	10/box
Male	1/2"	A	Steel	–	–	CP9	10/box
Male	1/2"	A	Steel	12-705	10/master*	–	–
Female	3/8"	B	Steel	–	–	CP10-23	10/box
Female	1/2"	B	Steel	–	–	CP10	10/box
Female	1/2"	B	Steel	–	–	CP10-50	50/box
Female	1/2"	B	Steel	12-713	5/master*	–	–
1/2" Body Series – Couplers							
Male	3/8"	D	Steel	–	–	C9-03	10/box
Male	1/2"	D	Steel	–	–	C9	10/box
Male	1/2"	D	Steel	–	–	C9-50	50/box
Male	1/2"	D	Steel	13-705	5/master*	–	–
Female	3/8"	E	Steel	–	–	C10-23	10/box
Female	1/2"	E	Steel	–	–	C10	10/box
Female	1/2"	E	Steel	–	–	C10-50	50/box
Female	1/2"	E	Steel	13-713	5/master*	–	–
Hose Barb	1/2"	F	Steel	–	–	C10-45	10/box
Recappers – Plugs							
Female	.307-32"	–	Steel	–	–	CP12	10/box
Recappers – Couplers							
Female	1/4"	–	Steel	–	–	C2R	10/box

*Carded display package



WARNING: Due to their large size, these couplers should not be connected or disconnected if the line pressure exceeds 40 PSI.

WARNING: Couplers and plugs are intended for use on compressed air lines only. All have maximum rated working pressure of 300 PSI.

PLUGS & COUPLERS

TRU-FLATE® Amflö®



A-Style Design

This design is identified by a 5/16" pilot and ball groove which is nearly round. It is similar in appearance to the Industrial interchange and care must be taken to correctly identify it. Couplers are available in both standard and push-to-connect style sleeve.

Thread	NPT	Style	Metal	Tru-Flate	Quantity	Amflo	Quantity
1/4" Body Series – Plugs							
Male	1/4"	A	Steel	–	–	CP37	10/box
Male	1/4"	A	Steel	–	–	CP37-100	100/box
Male	1/4"	A	Steel	12-325	10/master*	–	–
Male	1/4"	A	Steel	12-325-2 ²	10/master*	–	–
Male	1/4"	A1	Aluminum	12-324G	10/box	–	–
Male	3/8"	A	Steel	–	–	CP37-03	10/box
Female	1/4"	B	Steel	–	–	CP38	10/box
Female	1/4"	B	Steel	–	–	CP38-100	100/box
Female	1/4"	B	Steel	12-335	10/master*	–	–
Female	1/4"	B	Steel	12-335-2 ²	10/master*	–	–
Female	1/4"	B1	Aluminum	12-334G	10/box	–	–
Female	3/8"	B	Steel	–	–	CP38-23	10/box
Hose Barb	1/4"	C	Steel	–	–	CP37-42	10/box
Lock-On	3/8"	K	Steel	–	–	CP37-44L	10/box

Plug/Coupler Sets

One each of Tru-Flate 12-325 and 13-335	13-301	10/master*	–	–
One each 13-334G, 12-324G, and 12-334G	13-307G	10/master*	–	–
One 13-324G, One 13-334G, Two 12-334G, and Three 12-324G	13-309G	10/master*	–	–
Two each 13-324G, Two 13-334G, Four 12-334G, and Six 12-324G	13-311G	10/master*	–	–

* - Carded display package

² - Two pack on a carded display package



13-309G

PLUGS & COUPLERS

TRU-FLATE® Amflo®

A
STYLE

A-Style Design

Thread	NPT	Style	Metal	Tru-Flate	Quantity	Amflo	Quantity
1/4" Body Series – Couplers							
Male	1/4"	D	Steel	–	–	C37	10/box
Male	1/4"	D	Steel	–	–	C37-100	100/box
Male	1/4"	D	Brass	13-324	10/box	–	–
Male	1/4"	D	Brass	13-325	10/master*	–	–
Male	1/4"	D1	Aluminum	13-324G	10/box	–	–
Male	3/8"	D	Steel	–	–	C37-03	10/box
Female	1/4"	E	Steel	–	–	C38	10/box
Female	1/4"	E	Steel	–	–	C38-100	100/box
Female	1/4"	E	Brass	13-334	10/box	–	–
Female	1/4"	E	Brass	13-334-07	100/box	–	–
Female	1/4"	E	Brass	13-335	10/master*	–	–
Female	1/4"	E1	Aluminum	13-334G	10/box	–	–
Female	3/8"	E	Steel	–	–	C38-23	10/box
Hose Barb	1/4"	F	Steel	–	–	C38-42	10/box
Hose Barb	3/8"	F	Steel	–	–	C38-44	10/box
1/4" Push Couplers							
Female	1/4"	H	Steel	–	–	C46	10/box
Female	1/4"	H	Steel	13-775	10/master*	–	–
3/8" Body Series – Plugs							
Male	3/8"	A	Steel	–	–	CP35	10/box
Female	3/8"	B	Steel	–	–	CP36	10/box
3/8" Body Series – Couplers							
Male	3/8"	D	Steel	–	–	C35	10/box
Female	3/8"	E	Steel	–	–	C36	10/box

*Carded display package



D



D1



E



E1



F



H

WARNING: Due to their large size, these couplers should not be connected or disconnected if the line pressure exceeds 40 PSI.
WARNING: Couplers and plugs are intended for use on compressed air lines only. All have maximum rated working pressure of 300 PSI.

PLUGS & COUPLERS

TRU-FLATE® Amflo®



L-Style Design

This plug is the most easily recognized design. The long 3/4" pilot is so distinctive it cannot be confused with any other designs. Couplers are available in sleeve type only.



Thread	NPT	Style	Metal	Tru-Flate	Quantity	Amflo	Quantity
1/4" Body Series – Plugs							
Male	1/4"	A	Steel	–	–	CP27	10/box
Male	1/4"	A	Steel	–	–	CP27-100	100/box
Male	1/4"	A	Steel	12-425	10/master*	–	–
Female	1/4"	B	Steel	–	–	CP28	10/box
Female	1/4"	B	Steel	–	–	CP28-100	100/box
Female	1/4"	B	Steel	12-435	10/master*	–	–
1/4" Body Series – Couplers							
Male	1/4"	D	Steel	13-424	10/box	–	–
Male	1/4"	D	Steel	13-425	10/master*	–	–
Female	1/4"	E	Steel	13-434	10/box	–	–
Female	1/4"	E	Steel	–	–	C28-100	100/box
Female	1/4"	E	Steel	13-435	10/master*	–	–
Plug/Coupler Set							
One each of 12-425 and 13-435				13-401	10/master*	–	–



HI FLO® Design

HI FLO® couplers and plugs are specifically designed for use in HVLP (High Volume, Low Pressure) situations, such as paint spray guns, abrasive blast cabinets and high cfm air tools. HI FLO® couplers and plugs can allow up to 70+ CFM of air flow, almost three times the air flow of standard couplers and plugs.

Thread	NPT	Style	Metal	Tru-Flate	Quantity	Amflo	Quantity
HI FLO® Series – Plugs							
Male	1/4"	F	Steel	–	–	CP91	10/box
Male	1/4"	F	Steel	–	–	CP91-100	100/box
Male	1/4"	H	Aluminum	12-924	10/box	–	–
Male	1/4"	H	Aluminum	12-925 ²	10/master*	–	–
Female	1/4"	G	Steel	–	–	CP90	10/box
Female	1/4"	G	Steel	–	–	CP90-100	100/box
Female	1/4"	I	Aluminum	12-934	10/box	–	–
Female	1/4"	I	Aluminum	12-935 ²	10/master*	–	–

* - Carded display package

² - Two pack on a carded display package

PLUGS & COUPLERS

TRU-FLATE® Amflo®



HI FLO® Design

Thread	NPT	Style	Metal	Tru-Flate	Quantity	Amflo	Quantity
HI FLO® Series – Swivel Plug							

Swivel Plugs Feature:

- Increased flow ensures your tools will provide maximum torque and optimal performance.
- 360° swivel helps air hose from kinking.
- Made with lightweight aluminum reducing user fatigue.

Male	1/4"	A	Aluminum	12-929	10/master*	–	–
------	------	---	----------	--------	------------	---	---

HI FLO® Series – Brass Push-To-Connect Couplers							
--	--	--	--	--	--	--	--

Brass Push-To-Connect Couplers Feature:

- Durable heavy duty brass construction.
- 50 CFM compared to 25 CFM of standard couplers.

Male	1/4"	B	Brass	–	–	C91	10/box
------	------	---	-------	---	---	-----	--------

Male	1/4"	B	Brass	–	–	C91-100	100/box
------	------	---	-------	---	---	---------	---------

Female	1/4"	C	Brass	–	–	C90	10/box
--------	------	---	-------	---	---	-----	--------

Female	1/4"	C	Brass	–	–	C90-100	100/box
--------	------	---	-------	---	---	---------	---------

HI FLO® Series – Aluminum Push-To-Connect Couplers							
---	--	--	--	--	--	--	--

Aluminum Push-To-Connect Couplers Feature:

- Lightweight T6 aluminum construction.
- Extreme corrosion resistance: stainless steel ball bearings, spring and valve.
- 70+ CFM, almost three times the air flow of standard couplers.

Male	1/4"	D	Aluminum	13-924	10/box	–	–
------	------	---	----------	--------	--------	---	---

Male	1/4"	D	Aluminum	13-925	10/master*	–	–
------	------	---	----------	--------	------------	---	---

Female	1/4"	E	Aluminum	13-934	10/box	–	–
--------	------	---	----------	--------	--------	---	---

Female	1/4"	E	Aluminum	13-935	10/master*	–	–
--------	------	---	----------	--------	------------	---	---

Plug/Coupler Sets							
--------------------------	--	--	--	--	--	--	--

One 13-934, One 12-934, and Two 12-924	13-903	10/master*	–	–
--	--------	------------	---	---

One 13-924, Two 13-934, Three 12-934, and Four 12-924	13-907	10/master*	–	–
---	--------	------------	---	---

HI FLO® Series – 6 pc Conversion Kit							
---	--	--	--	--	--	--	--

Aluminum Push-To-Connect Couplers Feature:

- Lightweight T6 aluminum construction.
- Extreme corrosion resistance: stainless steel ball bearings, spring and valve.
- 70+ CFM, almost three times the air flow of standard couplers.
- Includes one each of 13-924, 13-934, 12-934, and two pieces of 12-924.

Male	1/4"	F	Aluminum	580-50ACK	10/box	–	–
------	------	---	----------	-----------	--------	---	---

* - Carded display package

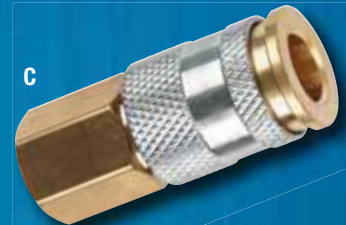

WARNING: Due to their large size, these couplers should not be connected or disconnected if the line pressure exceeds 40 PSI.
WARNING: Couplers and plugs are intended for use on compressed air lines only. All have maximum rated working pressure of 300 PSI.

PLUGS & COUPLERS

TRU-FLATE® Amflo®

ST
STYLE

ST-Style Design

These couplers and plugs have no valves. Smooth straight-thru bore allows maximum flow. Made from solid brass bar stock. Couplers have stainless steel springs and balls. Excellent for carpet cleaners, vacuum service and pressure washers. Interchanges with Parker ST type.

Thread	NPT	Style	Metal	Tru-Flate	Quantity	Amflo	Quantity
Straight-Thru Series – Plugs							
Male	3/8"	A	Brass	–	–	CPST5B	10/box
Female	1/4"	B	Brass	–	–	CPST4B	10/box
Female	1/4"	C	Brass	–	–	CPST17B	10/box
Female	3/8"	B	Brass	–	–	CPST6B	10/box
Female	1/2"	B	Brass	–	–	CPST8B	10/box
Straight-Thru Series – Couplers							
Female	1/4"	D	Brass	–	–	CST4B	10/box
Female	1/4"	E	Brass	–	–	CST17B	10/box
Female	3/8"	D	Brass	–	–	CST6B	10/box
Female	1/2"	D	Brass	–	–	CST8B	10/box

D
STYLE

D-Style Design

Diamond-U are primarily found on the West Coast. Plated steel couplers have hardened steel balls and stainless steel plugs. Plugs are heat treated to reduce wear on critical mating surfaces.

Thread	NPT	Style	Metal	Tru-Flate	Quantity	Amflo	Quantity
Diamond-U Series – Plugs							
Male	1/4"	F	Steel	–	–	CP33	10/box
Female	1/4"	G	Steel	–	–	CP34	10/box
Diamond-U Series – Couplers							
Male	1/4"	H	Steel	–	–	C31	10/box
Female	1/4"	I	Steel	–	–	C30	10/box

WARNING: Due to their large size, these couplers should not be connected or disconnected if the line pressure exceeds 40 PSI.

WARNING: Couplers and plugs are intended for use on compressed air lines only. All have maximum rated working pressure of 300 PSI.

PLUGS & COUPLERS

TRU-FLATE® Amflo®



Universal Design

Can be used with T, I/M and A Design 1/4" plugs, eliminating confusion among designs. Deluxe push-to-connect style makes coupling quick and easy. Heavy duty brass or composite construction means longer life. Unique tubular valve design allows greater air flow, up to 35 CFM. **3 Year Leak Proof Guarantee!**

Thread	NPT	Style	Metal	Tru-Flate	Quantity	Amflo	Quantity
Combo Coupler® • 3 Year Leak-Proof Guarantee							
Male	1/4"	A	Brass	13-512	10/box	-	-
Male	1/4"	A	Brass	13-513	10/master*	-	-
Female	1/4"	B	Brass	13-514	10/box	-	-
Female	1/4"	B	Brass	13-515	10/master*	-	-
Swivel Coupler							
Female	1/4"	C	Brass	13-518	6/master*	-	-
Composite Universal Coupler							
Female	1/4"	D	-	-	-	C60C	10/box

*Carded display package

Safety Design

Safety couplers are made from light-weight, corrosion resistant composite and aluminum materials making them safer to use. The push button safety release eliminates air pressure and blow back when connecting and disconnecting air hoses and tools. Safety couplers are designed to be used with I/M and T style plugs. Available in black, hi-vis orange for added safety.

- Couplers can be used with I/M and T style plugs.
- Push-Button 2-step safety design. Push once to vent the air line, push again to release the plug.
- Composite body is perfect for use with paint guns.

Thread	NPT	Style	Color	Metal	Tru-Flate	Quantity	Amflo	Quantity
Safety Couplers								
Male	1/4"	E	Black	Steel/ Aluminum	13-229	5/master*	-	-
Female	1/4"	F	Black	Steel/ Aluminum	13-239	5/master*	-	-

*Carded display package

WARNING: Due to their large size, these couplers should not be connected or disconnected if the line pressure exceeds 40 PSI.
WARNING: Couplers and plugs are intended for use on compressed air lines only. All have maximum rated working pressure of 300 PSI.



INFLATOR GAUGES

TRU-FLATE® Amflo®



101TF

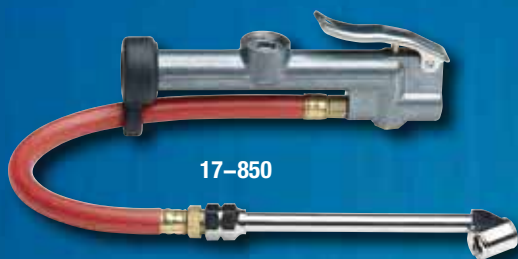

17-850



17-855



17-860

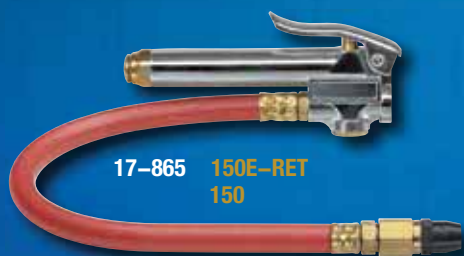

17-865 150E-RET
150



17-863

• Tru-Flate • Amflo

Standard Duty Inflator Gauge

Zinc die cast housing with zinc plated steel lever. Swivel dual foot chuck and replaceable brass cartridge. Complete with bleeder valve to easily release tire over inflation. Calibrated 20–120 PSI in 2 PSI increments.

With 12" Hose and Dual Foot Chuck.

101TF Carded. 10/master.

Deluxe Inflator Gauges

Rugged zinc casting, with rubber bumper guard to protect against damage if dropped, and easy-to-read recessed sight glass. Replaceable valve assembly and gauging cartridge. Calibrated 10–120 PSI in 2 lb. steps.

With 12" Hose and Dual Foot Chuck.

17-850 Carded. 10/master.

With 24" Hose and Clip-On Chuck.

17-855 1/box.

Deluxe Straight-On Inflator Gauges *with Bleeder Valve*

Same high quality inflator gauge but with a convenient bleeder valve to enable the operator to "zero" the gauge and release pressure during filling. Allows the operator to stand away from the tire being inflated and thus meets OSHA regulation No. 1910.177.

With 36" Hose and Straight-On Dual Foot Chuck.

17-860 1/box.

NOTE: Because of the internal construction of the Straight-On Dual Foot Chucks, they can only be installed on Tru-Flate® inflator gauges with bleeder valves.

Bayonet Style Inflator Gauges

Features rubber hose and chrome plated castings with brass internal parts for long life. Solid brass bar is calibrated 10–90 PSI in 2 PSI increments.

With 12" Hose and Straight-On Tapered Chuck.

17-865 Carded. 5/master. **150E-RET** Carded. 5/master.

150 1/box.

150-50 Bulk. 50/box.

With 12" Hose and Swivel Dual Foot Chuck.

17-863 1/box.

INFLATOR GAUGES

TRU-FLATE® Amflo®

• Tru-Flate • Amflo

Heavy Duty Inflator Gauges

Heavy chrome plated castings with protective sleeve over dial tube. Plated steel handle is riveted to body. Solid brass bar is calibrated 10 to 120 PSI in 2 PSI increments.

Highly Accurate Dial Inflator

Easy-to-read dial is calibrated 0 to 160 PSI. Tapered chuck and swivel dual foot make getting into tight spots easy. A must for racing tires and truck fleets.

135 1/box.

Straight-On Tapered Chuck Inflator with 12" hose.

100D Carded. 1/master.

Swivel Dual Foot Chuck Inflator with 12" hose

For use on vehicles with smaller dual wheels.

101D Carded. 1/master.

Straight-On Dual Foot Chuck Inflator

Durable black epoxy finish.

101HD 1/box.

Master Air Inflator Gauges

Inflates and checks pressure of passenger cars, motorcycles and trucks. Has a five ft. hose length. Dual calibrated 10 to 170 PSI and .7 to 12 bar. Calibrated in 2 lb. increments.

3910S Master Air Inflator Gauge with standard bore. 1/box.

3912 Master Air Inflator Gauge with 1/4" MNPT fitting. 1/box.

Digital Inflator Gauges

Users can watch the highly accurate back-lit digital read-outs while inflating or deflating for more precise pressure. The 17-878 is complete with air bleeder valve, 13.5" hose and straight-on dual foot chuck. The 17-877 has a robust pistol grip handle and two stage trigger for inflation and deflation. Complete with 20" swivel hose with bend restrictor and clip-on chuck. Rubber covers protect units in the event of a drop. Measures in PSI, bar, kPa and kgF/cm².

17-878 Carded. 5/master. 0-200 PSI.

17-877 Carded. 1/master. 0-174 PSI.

Inflator Gauge Components (not shown)

112 12" Hose with Straight-On Chuck 1/box.

113 12" Hose with Dual Foot Chuck. 1/box. Converts 3/8-24 thread hose to 1/4-18 NPT and 1/8-27 NPT.

150LW-50 Bayonet Inflator Gauge Body. 50/box.

100LW Heavy Duty Inflator Gauge Body. 1/box.

135DG Replacement Dial Gauge. For Amflo 135. 1/box.

153 Dial Bar for Bayonet Gauge. 1/bag.

163 Replacement Inflator Gauge Valve. For Amflo 150 series. 1/box.

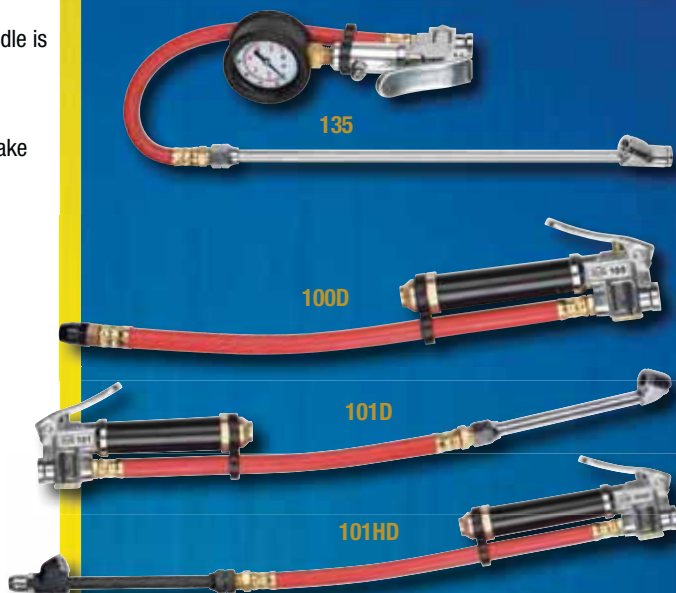

AIR LINE CHUCKS

TRU-FLATE® Amflo®



17-355



17-722



17-365



17-726

107



127



106-100



17-730



17-732



105



17-351

104



17-353

104CA

• Tru-Flate • Amflo

Air Line Chucks without Shut-Off *for Inflator Gauges only*
Do not use on direct air lines where a shut-off valve is required.

Snap-On Chuck Clip

Converts any single foot chuck to a clip-on chuck. Used with both Direct Lines and Shut-offs.

17-355 Carded. 10/master.

Mini Lock-On Air Chuck with 1/4" Hose Barb

Newer "mini-style" is standard equipment on rim clamp (RC) tire changers.

17-365 Carded. 10/master.

Single Ball Foot Chuck

1/4" FNPT.

17-722 10/box.

Dual Foot Chuck

1/4" FNPT

107 1/box.

"Grip Tite" Chuck

1/4" FNPT. Straight-on air line chuck. Snaps onto standard tire valve and stays put until disconnected.

17-726 1/bag.

Straight-On Chuck

1/4" FNPT, with universal adapter.

127 10/box.

Straight-On Chuck with 1/4" Hose Barb

106-100 Bulk. 100/box.

Clip-On Chuck

1/4" FNPT, with universal adapter.

17-730 10/box.

Straight Lock-On Chuck

1/4" FNPT. Flow-through.

17-732 10/box.

Angled Chuck

1/4" FNPT.

105 10/box.

Air Line Chucks with Shut-Off *not for Inflator Gauge use*

Direct Air Line Chucks have a built-in shut-off valve and therefore cannot be used on inflator gauges. Use when air supply lines come directly from the compressor with no other valve in the line. 1/4" female NPT. 150 PSI maximum air line pressure.

Ball Foot Chucks

17-351 Carded. 10/master. 104 10/box.

Clip-On Chuck

17-353 Carded. 10/master. 104CA 10/box.

AIR LINE CHUCKS

TRU-FLATE® Amflo®

• Tru-Flate • Amflo

Air Line Chucks with Shut-Off *not for Inflator Gauge use*

- 17-361 Ball Foot Chuck with 1/4" Hose Barb. Carded. 10/master.
- 17-362 Straight Lock-On Chuck. 10/box.
- 17-369 Ball Foot Chuck. 1/4" MNPT. Carded. 10/master.

"Grip Tite" Chuck

Works like a "quick coupler." Snaps onto any standard tire valve and stays put until released.

- 17-373 Carded. 10/master. 119 10/box.

Straight-On Chuck

Smaller design for use on those hard-to-reach tire valves.

- 126 10/box.

Dual Foot Chuck

Dual foot extension for valves on tractors, trucks or buses.

- 17-383 Carded. 10/master.
- 17-382 10/box.

Straight-On Dual Foot Chuck

For hard-to-reach inner duals.

- 17-385 Carded. 10/master. 108 1/box.
- 121 12" length. 1/box.

Dual Foot Safety Lock-On Chuck

- 118D Carded. 1/master.

Locking Straight-On Dual Foot Chuck

Comes with threaded deep well lock nut which locks on valve when tilted.

- 17-395 Carded. 10/master.
- 17-396 10/box.
- 17-398 12" length (14" overall). 5/box.

Large Bore Clip-On Air Chuck

Snaps on the large bore valve when sleeve is moved forward and releases when sleeve is pulled back. 1/4" NPT.

- 17-392 1/bag.

Large Bore Chuck

Grips bore valve when tilted on threads.

- 17-394 1/box.

Air Line Chuck Service Parts *(not shown)*

- 859W Chuck Washer. For Straight-On and Dual Foot Chucks. 10/box.



17-361

17-362

17-369



17-373

119



126



17-382
17-383

17-385
17-395
17-396
108



121
17-398

118D



17-392



17-394

HI FLO® BLOWGUNS

TRU-FLATE® Amflo®



18-607



18-613



18-623



18-612

• Tru-Flate • Amflo

HI FLO® Blowguns

Tru-Flate HI FLO® Blowguns combine ergonomics with power for an enhanced experience. Durable lightweight aluminum bodies and easy ergonomic grip provides maximum comfort and control, reducing operator fatigue. Complete with handy hang-up hook for easy storage. No tools needed for modular accessories that help with reach, protection and increased air flow. OSHA compliant tips meet or exceed standards. All HI FLO® Blowguns are equipped with 1/4" FNPT threads.

TF1 HI FLO® Blowgun – 40 CFM

18-607 Carded. 10/master. Includes Safety Nozzle.

18-611 Carded. 10/master. Includes Safety Nozzle and Rubber Tip. (*not shown*)

18-609 Carded. 10/master. Includes Safety Nozzle, Rubber Tip and (2) 12" Extensions. (*not shown*)

18-613 Carded. 10/master. Includes Safety Nozzle, Rubber Tip, Quiet High Flow Tip, (2) 6" Extensions, (3) Inflation Needles and Tip Adapter.

18-623 Carded. 10/master. Includes Safety Nozzle, Rubber Tip, HI FLO® Female Coupler, HI FLO® Female Plug and (2) HI FLO® Male Plugs.

TF3 HI FLO® Blowgun – 50 CFM with larger body and variable trigger for controlled flow.

18-608 Carded. 5/master. Includes Safety Nozzle. (*not shown*)

18-612 Carded. 5/master. Includes Safety Nozzle and Rubber Tip.

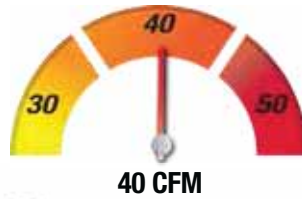

• Tru-Flate • Amflo

HI FLO® Blowgun Modular Accessories

Add up to six 12" extensions when a longer reach is required. Use the OSHA compliant Tri-Thrust Tip when more air flow is needed. Protect your face and surroundings with the HI FLO® compatible Chip Shield.

12" Extension (2 pack)
18-621 Carded. 10/master.

Tri-Thrust Tip
18-615 Carded. 10/master.

Chip Shield
18-617 Carded. 10/master.

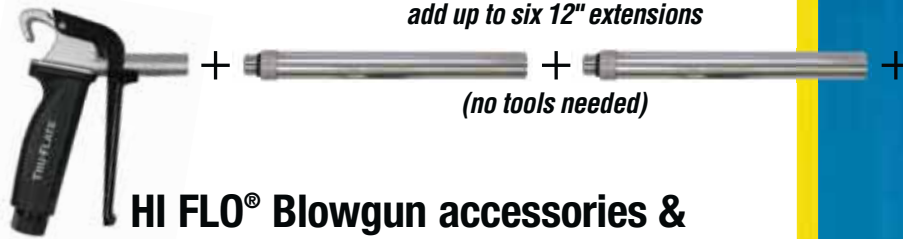

HI FLO® Blowgun accessories & what they're used for

All HI FLO® Blowgun accessories fit both the TF1 & TF3 Blowguns

Ref.	Description	Used For
A	Rubber Tip	Inflate air toys, air mattress, and other inflatables that have round inflation valve / plug.
B	Quiet High Flow Tip, OSHA compliant (1910.95) (1910.242)	Use in workshop to blow dirt / dust.
C	Safety Nozzle, OSHA compliant (1910.242)	Use in workshop to blow dirt / dust.
D	Tri-Thrust Tip	Use in workshop to blow dirt / dust, blows a wider area than some of the other tips.
E	Tip Adapter	Use with the Inflator Needles.
F	Chip Shield	Use with blowgun extensions to shield debris blowback and splatter.
G	Inflator Needles	Use to inflate sports equipment and in tight areas or cracks.
H	6" Extension	Use with any of the HI FLO® tips or nozzles when a longer reach is required.
I	12" Extension	Use with any of the HI FLO® tips or nozzles when a longer reach is required.

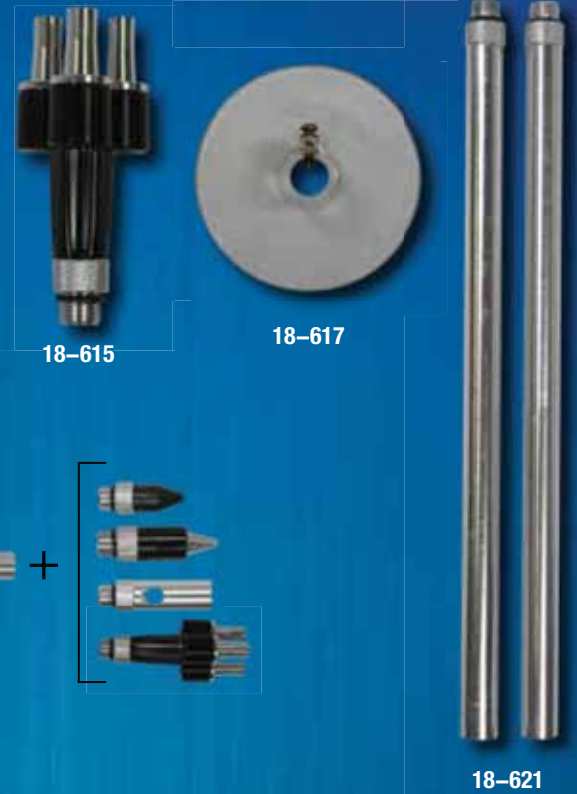

BLOWGUNS

TRU-FLATE® Amflo®



• Tru-Flate • Amflo

Standard Blowguns

All have 1/4" female NPT inlet – allows full line pressure to be used.

IMPORTANT: To comply with OSHA regulations, Standard Blowguns must be used on a regulated air line with a pressure setting not to exceed 30 PSI.

Standard Blowgun

Comfortable thumb lever valve control with hang hook. One-piece nozzle.

18-203 Carded. 5/master. **200** 1/box.
200-100 Bulk. 100/box.

Standard Blowgun with Rubber Tip

Oil resistant, soft replaceable rubber tip. Will not mar delicate surfaces. Gives a leak-proof seal against oil passages, fuel lines, etc., when air pressure is needed for cleaning.

18-207 Carded. 5/master. **201** 1/box.

Flex-Tipped Blowgun

No handles, levers or buttons. Simply flex rubber nozzle to open. Release, and air shuts off automatically.

211 10/box.
211-100 Bulk. 100/box.

Siphon Spray Blowgun

Combination of a Standard Blowgun and the Siphon Spray Nozzle. Barbed siphon inlet fits 1/4" ID hose or tubing. Use for spray-cleaning engines, applying protective coatings, etc.

18-221 Carded. 5/master.

Pistol-Grip Spray Cleaner

Air-operated siphon cleaning gun handles most cleaning fluids. Ideal for mixing water or soap solutions for pressure cleaning of parts, engines, machinery, floors and walls. Dual air inlet allows handy overhead or under-bench connection. Includes 8' of clear vinyl tubing with a weighted strainer screen and fluid control valve. 10" spray nozzle.

18-225 Carded. 5/master.

Deluxe Blowgun Kit

All purpose blowgun kit with 4 interchangeable nozzles for cleaning and inflating. Perfect for blowing sawdust and grass clippings, drying surfaces or inflating balls, rafts and air mattresses. Complete with Standard Nozzle, Rubber Tip Nozzle, Tapered Inflator Nozzle and Ball Inflator Needle – all in a convenient see-through plastic storage case.

18-241 Carded. 5/master.

• Tru-Flate • Amflo

Standard Blowguns (cont.)

Palm Style Blowgun Kit

Lightweight, ergonomic design blowgun fits comfortably in the palm of your hand. Kit includes 6 interchangeable nozzles, 1/4" air plug and a 12" hose and air chuck assembly.

18-247 Carded. 5/master.

Pistol-Grip Blowgun

Lightweight plastic pistol-grip blowgun with ergonomic design reduces user fatigue. Brass valving and bushing ensure long life.

18-325 Carded. 5/master.

Heavy Duty Angle Tip Blowgun

Heavy duty construction and rubber tip. Excellent for blowing out automatic transmissions.

205ATD Carded. 5/master.

Heavy Duty Blowgun

Use in construction and other rugged applications. Standard 1/8" NPT nozzle thread.

205D Carded. 5/master.

Booster Blowgun

Delivers extra wide spray pattern. Additional air is drawn through holes around nozzle.

226 1/box.

Safety Blowguns

Improved nozzle gives greatly increased performance and yet still meets OSHA regulation 100-1 for 30 PSI "dead head" pressure. Vented nozzle relieves compressed air should nozzle become plugged or obstructed. Heavy duty die-cast body with hang-up hook and 1/4" NPT female inlet.

Button Type Inlet pressure 150 PSI.

18-231 Carded. 5/master.

Lever Type Inlet pressure 150 PSI.

18-233 Carded. 5/master.

204-30 1/box.

Tamper-Proof Lever Type. Safety nozzle cannot be removed from end.

18-237 Carded. 5/master.

204-30A 1/box.

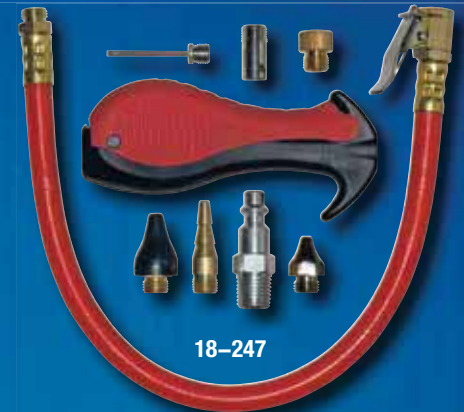

18-247



18-325

205ATD



205D

226

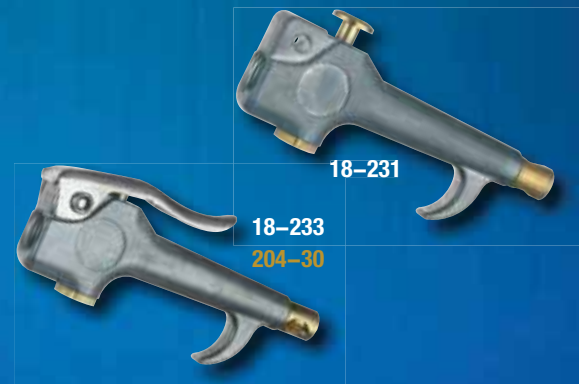

18-231

18-233
204-30



18-237
204-30A

BLOWGUNS

TRU-FLATE® Amflö®

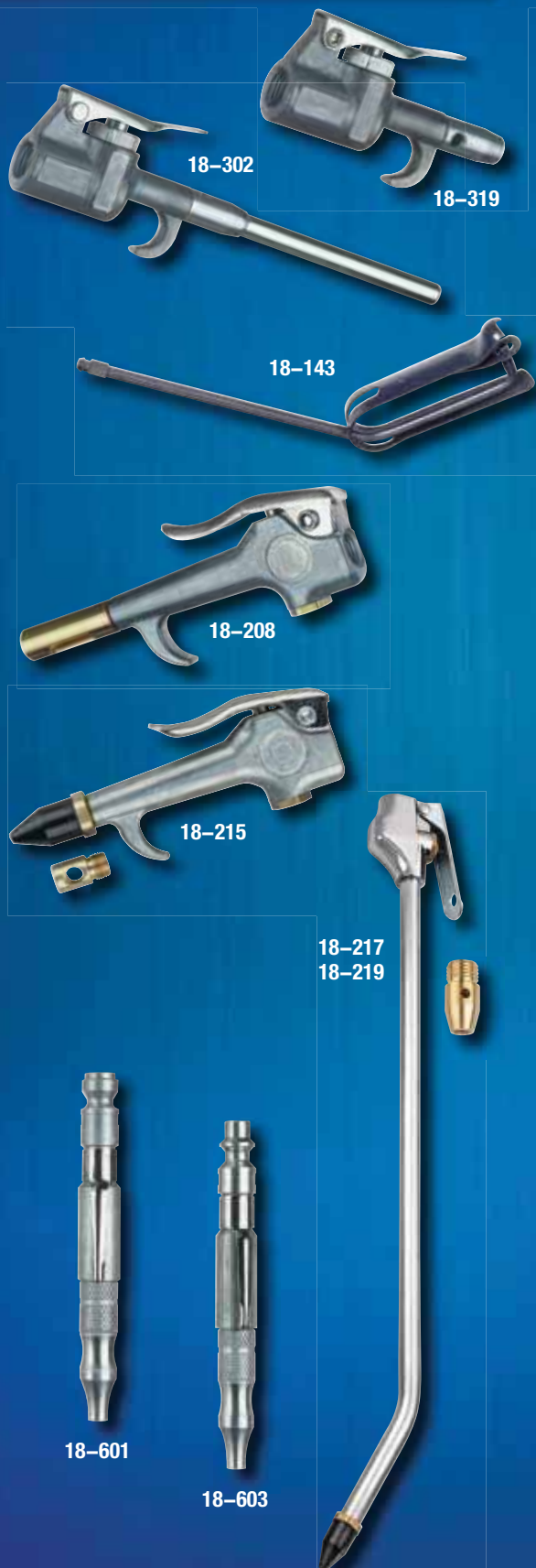

• Tru-Flate • Amflo

Safety Blowguns *cont.*

Pocket Size Lever Type Inlet pressure 150 PSI.

18-319 Carded. 5/master.

18-302 Carded. 10/master. With 4" Extension.

Clip-On Safety Blowgun. Chuck style, 8-1/2".

Converts standard ball foot air chuck into a blowgun.

18-143 10/box.

High Volume "Venturi" Action

Delivers more air-to-speed cleaning and drying while using less compressed air. Special venturi nozzle increases air flow to part, yet meets OSHA regulation 100-1. Convenient hang-up hook, comfortable lever and 1/4" NPT female inlet. Inlet pressure 150 PSI.

18-208 1/box.

Safety Blowgun with Rubber Tip & Safety Nozzle

Oil resistant, soft rubber tip seals tight and won't mar finishes. Ideal for cleaning fuel lines, air passages and carburetors. Limits air pressure to 30 PSI, meeting OSHA safety standards. Convenient hang-up hook. 1/4" NPT female inlet. Inlet pressure 150 PSI.

18-215 Carded. 5/master.

Safety Extension Blowgun with Rubber Tip & Safety Nozzle

These multi-function, long reach blowguns come with both a safety nozzle and rubber tip. End of blowgun is bent for hard-to-reach areas.

18-217 With 2' extension. 1/bag. 5/master.

18-219 With 4' extension. 1/bag. 5/master.

Adjustable Safety Pocket Blowguns

A must for home, shop or garage use. Quick and easy to use - just attach to air line coupler and twist knurled nozzle. For 1/4" coupler bodies. Meets OSHA regulation 100-1. Complete with handy pocket clip.

T-Style Design

18-601 Carded. 10/master.

I/M Style Design

18-603 Carded. 10/master.

• Tru-Flate • Amflo

Blowgun Accessories

Blowgun tips and extensions on this page have 1/8" NPT male threads.

Standard Chrome Plated Extension. 1/4" tubing. 6" length.

200E6 1/bag.

Inflation Needles. All 1/8" NPT.

18-245 1-1/4" length. Carded 4 pack. 6/master.

200NT-1 2-3/4" length. 10/box.

200NT-2 2-1/2" length. 10/box.

200NT-4 1-1/8" length. 10/box.

Flexible Metal Extension. Use for air or coolant lines. 8" length.

200F8 1/bag.

Safety Extensions. With safety bypass – cannot be dead-ended.

204E12 12" length. 1/bag.

Safety Nozzle. For Tru-Flate 18-215, 18-231 and 18-233; Amflo 204-30.

97-412 20/box.

Rubber Replacement Tip. For Tru-Flate 18-207, 18-215 and Amflo 201 blowguns.

99-005 Carded. 10/master. **202** 10/box.

Venturi Tip. For Tru-Flate 18-208 blowguns.

209 10/box.

Siphon Spray Nozzle. For Tru-Flate 18-221 blowguns.

221 10/box.

Booster Replacement Tip. For Amflo 226 blowguns.

227 1/box.

Heavy Duty Blowgun / Inflater Repair Kit. Everything you need for quick, easy repairs. Contains valve stem, O-rings, spring and nut.

40-205RK 1/bag.



HOSE FITTINGS

TRU-FLATE® Amflo®



Male Hose End



Male Swivel Fitting



Female Hose End



Female Swivel Fitting



Hi-Volume Swivel Fitting



Lock-On Swivel Fitting



Lock-On Hose Barb

• Tru-Flate • Amflo

Barbed Hose Fittings

All brass construction resists rust and will not corrode as easily as other materials. Precision machined to high quality standards. Use with hose clamp or ferrules.

Male Hose End

- 399** 1/8" Hose ID x 1/8" MNPT. 10/box.
- 404** 1/4" Hose ID x 1/8" MNPT. 10/box.
- 401** 1/4" Hose ID x 1/4" MNPT. 10/box.

21-123 1/4" Hose ID x 1/4" MNPT. Carded. 10/master.

- 604** 1/4" Hose ID x 3/8" MNPT. 10/box.
- 398** 1/4" Hose ID x 3/8"-24. With O-ring. 10/box.

21-133 5/16" Hose ID x 1/4" MNPT. Carded. 10/master.

- 21-143** 3/8" Hose ID x 1/4" MNPT. Carded. 10/master.
- 406** 3/8" Hose ID x 1/4" MNPT. 10/box.
- 406-100** 3/8" Hose ID x 1/4" MNPT. Bulk. 100/box.

21-147 3/8" Hose ID x 3/8" MNPT. Carded. 10/master.

- 408** 1/2" Hose ID x 1/4" MNPT. 10/box.
- 608** 1/2" Hose ID x 3/8" MNPT. 10/box.
- 808** 1/2" Hose ID x 1/2" MNPT. 10/box.

Male Swivel Fitting

- 401S** 1/4" Hose ID x 1/4" MNPT. 10/box.

Female Hose End

- 21-222** 1/4" Hose ID x 1/4" FNPT. 10/box.
- 21-242** 3/8" Hose ID x 1/4" FNPT. 10/box.

Female Swivel Fitting

- 21-323** 1/4" Hose ID x 1/4" FNPS. Carded. 10/master.

Hi-Volume Swivel Fitting

- 406S** 3/8" Hose ID x 1/4" MNPT. 10/box.

Lock-On Hose Barbs

Designed to use with lock-on hose. No ferrules or hose clamps are required. Not to be used with conventional hose.

- 406L** 3/8" Hose ID x 1/4" MNPT. 10/box.
- 446SL** Swivel fitting, 3/8" Hose ID x 1/4" MNPT. 10/box.

• Tru-Flate • Amflo

Hose Splicers

Used to connect two air hoses to create a longer hose, or fix a broken hose in the field.

21-423 1/4" Hose ID. Carded. 10/master.

21-433 5/16" Hose ID. Carded. 10/master.

602 3/8" Hose ID. 10/box.

21-467 3/8" Hose ID. Carded. 10/master.

21-488 1/2" Hose ID. 10/box.

360° Swivel Fittings

Eliminates kinked and twisted air line hose by swiveling a full 360°. Barb type and male/female connections. 150 PSI maximum working pressure.

21-601 1/4" MNPT x 1/4" Hose Barb. Carded. 10/master.

21-603 1/4" MNPT x 3/8" Hose Barb. Carded. 10/master.

21-605 1/4" MNPT x 1/4" FNPT. Carded. 10/master.

Hose Clamps

Gear type clamps permit quick hose repair with simple tools. Rugged construction featuring a stainless steel band and plated steel screw.

1/4" to 5/8" Hose OD, 5/16" clamp width.

580-100 Bulk. 100/box.

3/8" to 7/8" Hose OD, 5/16" clamp width.

581-100 Bulk. 100/box.

1/2" to 1-1/4" Hose OD, 5/16" clamp width.

582 10/box.

Hose Repair Kit

Contains all parts necessary to repair a direct air line hose assembly.

- Single Foot Air Chuck, 1/4" Female NPT
- Male Hose End Fitting, 1/4" ID hose x 1/4" NPT
- Hose Splicer, 1/4" ID hose
- 3 Hose Clamps, fits 3/8" ID hose

41-300 Carded. 5/master.

Hose Repair Kit

Contains all parts necessary to repair a direct air line hose assembly.

- Male Hose End Fitting, 1/4" ID hose x 1/4" MNPT
- Hose Splicer, 1/4" ID hose
- 3 Hose Clamps, fits 3/8" ID hose

41-303 Carded. 5/master.

Hose Repair Kit

Contains all parts necessary to repair a direct air line hose assembly.

- Male Hose End Fitting, 3/8" ID hose x 1/4" MNPT
- Hose Splicer, 3/8" ID hose
- 3 Hose Clamps, fits 3/8" ID hose

41-305 Carded. 5/master.



Hose Splicer



360° Swivel Fitting

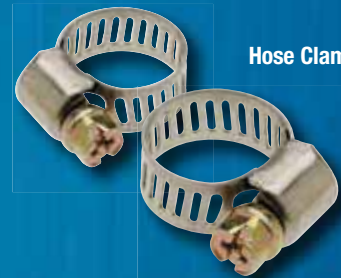

Hose Clamps

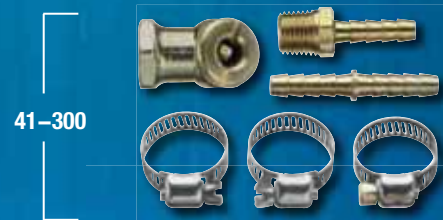

41-300



41-303



41-305

HOSE FITTINGS

TRU-FLATE® Amflo®



Male Coupling



Female Coupling



Female Bushing



Ball-End Adapter



Drain Cock



Reusable Hose Fittings



• Tru-Flate • Amflo

Pipe Couplings and Adapters

All brass, corrosion resistant material. Allows user to adjust thread sizes from 1/8" NPT through 1/2" NPT with either male or female ends.

Male Couplings

- 21-505** 1/4" MNPT x 1/4" MNPT. Carded. 5/master.
344 1/4" MNPT x 1/4" MNPT. 10/box.
346 3/8" MNPT x 1/4" MNPT. 10/box.
366 3/8" MNPT x 3/8" MNPT. 10/box.
388 1/2" MNPT x 1/2" MNPT. 10/box.

Female Couplings

- 21-515** 1/4" FNPT x 1/4" FNPT. Carded. 5/master.

Female Bushings

- 21-535** 1/4" FNPT x 3/8" MNPT. Carded. 5/master.
346F 1/4" FNPT x 3/8" MNPT. 10/box.
348F 1/4" FNPT x 1/2" MNPT. 10/box.
368F 3/8" FNPT x 1/2" MNPT. 10/box.

Ball-End Adapters

- 21-595** 1/4" MNPT x 1/4" MNPS with ball socket. Carded. 5/master.
21-597 1/4" MNPT with ball socket x 1/4" MNPS with ball socket. Carded. 10/master.

Drain Cocks. 150 PSI.

- 21-555** 1/8" Drain Cock. Carded. 10/master.
21-557 1/4" Drain Cock. Carded. 10/master.

Reusable Hose Fittings

Eliminates the need for hose clamps or ferrules. Heavy duty construction. Designed for fast, easy, yet permanent air-tight connections.

- 418** 1/2" Hose OD, 1/4" Hose ID, 1/4" MNPT. 10/box.
419 5/8" Hose OD, 1/4" Hose ID, 1/4" MNPT. 10/box.
22-163 11/16" Hose OD, 3/8" Hose ID, 1/4" MNPT. Carded. 10/master.
623 3/4" Hose OD, 3/8" Hose ID, 1/4" MNPT. 10/box.

• Tru-Flate • Amflo

Female Crosses

Excellent for running several air lines from a common source. Solid brass.

344X 1/4" NPT. 10/box.

Female Tees

Excellent for running 2 air lines from a common source. Solid brass.

344T 1/4" NPT. 10/box.

3-Way Manifolds

Supply 3 air tools from one source. Use on air hose end or as permanently fixed bench outlet. No need to disconnect/connect to use different tools.

Machined aluminum construction.

1/4" FNPT inlet x 1/4" FNPT outlet.

41-125 Carded. 5/master.

3404 1/box.

3/8" FNPT inlet x 1/4" FNPT outlet.

3406 1/box.

1/2" FNPT inlet x 1/4" FNPT outlet.

3408 1/box.

In-Line Swivel Fittings

Permits rotation of fitting without kinking or twisting of hose.

344R 1/4" male/female NPT. 10/box.

366R 3/8" male/female NPT. 300 PSI. 10/box.

Uniswivel Fitting

Full 360° swivel action. 300 PSI. 1/4" MNPT x 1/4" FNPT.

21-607 Carded. 10/master.

344U 10/box.

Dual Swivel Fitting

Full 360° swivel action. 300 PSI. 1/4" MNPT x 1/4" I/M plug.

21-609 Carded. 10/master.

Safety Valves

Constructed to ASME standards. Interchangeable with all other ASME valves of the same size and pressure. Furnished with relief pressure preset.

21-707 1/4" Safety Valve 125 PSI. Carded. 5/master.

21-709 1/4" Safety Valve 150 PSI. Carded. 5/master.



Female Cross

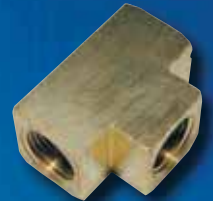

Female Tee



3-Way Manifold



Uniswivel Fitting



In-Line Swivel Fitting



Dual Swivel Fitting



Safety Valve

AIR LINE HOOK-UP HINTS

TRU-FLATE® Amflö®

Proper usage of compressed air power calls for filters to clean the air, regulators to control pressure, gauges to show pressure and lubricators to protect power tools. Air line systems also need hose and tubing to provide flexibility at the points of use. Couplers, plugs and fittings are the components that complete the systems for quick, easy, secure fastening to paint spray guns, blowguns, inflator gauges, chucks, power tools and pneumatic tire repair stands. Amflo® and Tru-Flate® components offer reliable, low-cost, readily available, proven ways to hook up your air line system.



LEADER HOSE

A short length of leader hose is recommended on a paint spray gun to keep the coupler and plug from scratching a painted surface.



DESICCANT AIR DRYERS

Deliver extremely clean, dry air to pneumatic system components. The use of desiccants will optimize the quality of compressed air to improve performance of air tools and ensure oil-free, dry air to auto paint spray equipment.

SAFETY BLOWGUNS

To comply with OSHA requirements, blowguns used on UNREGULATED air lines must be capable of restricting nozzle pressure to 30 PSI or less when dead-ended.



DIRECT AIR LINE CHUCKS



AIR HOSE

AIR LINE FILTERS

ALWAYS LOCATE YOUR FILTER AS FAR FROM THE COMPRESSOR AS POSSIBLE IN ORDER TO TRAP AS MUCH CONDENSATION AS POSSIBLE.



Amflo and Tru-Flate two-stage filters remove liquids, oil, water and large dust particles by centrifugal force, and small dust particles down to 40 microns by a porous element filter. Air line filters are vital to protect expensive air powered tools to keep them operating longer with greater efficiency.

INFLATOR GAUGES



INLINE TOOL FILTER



TIRE HARDWARE



PRESSURE GAUGES

TANK VALVES



AIR LINE HOOK-UP HINTS

TRU-FLATE® Amflō®

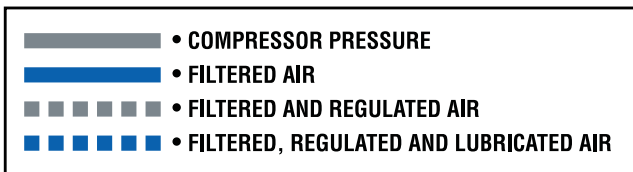

AT-HAND® REGULATOR
Regulator allows custom pressure settings for various tools without having to go back to the compressor.

PRESSURE REGULATORS
Pressure regulators reduce line pressure to a usable range – a lower pressure than the compressor is set to deliver. Regulators maintain a steady flow of air regardless of the fluctuations that may take place in line pressure.

Pressure regulators should be used on air lines which feed impact wrenches in order to control tightening torque AND ON ALL AIR LINES THAT FEED STANDARD BLOWGUNS TO COMPLY WITH OSHA REGULATIONS. Regulators must be set at 30 PSI or less.

AIR LINE FILTERS



COMBINATION FILTER/REGULATORS
This unit is equipped with an automatic drain, providing the user with a clean, moisture-free air supply and saving money too!

The large filter surface area minimizes pressure drop, and is RECLEANABLE. The regulator portion of the unit is extremely stable in low-flow applications, and a balanced valve design prevents secondary pressure changes with fluctuating primary pressures.

This unit should always be located as far away from the compressor as possible.



BRASS THREAD ADAPTERS

RECOIL AIR HOSE
Self-retracting nylon or poly air hose is ideal for hook-up to portable air powered tools. By recoiling, it keeps "out from underfoot" by itself.



STANDARD BLOWGUNS
Must be used on pressure REGULATED lines in order to comply with OSHA requirements. Set regulator at 30 PSI or less.



LEADER HOSE

RECOMMENDED AIR POWERED TOOL HOOK-UP
Air powered tools such as impact wrenches and panel cutters generate intermittent shock loads to make them work. If a coupler and plug are installed directly to the tool, this can cause PREMATURE FAILURE of the coupler. ALWAYS USE A SHORT LENGTH OF LEADER HOSE BETWEEN THE TOOL AND THE COUPLER AND PLUG TO ABSORB AS MUCH OF THE SHOCK AS POSSIBLE.

AIR LINE LUBRICATORS
MODERN AIR POWERED TOOLS NEED LUBRICATION! Lubricators protect expensive power tools Ultrasonic generators deliver oil in a fine mist form. Lubricators are simple to adjust. Loading bowl can be filled from either side.

ALWAYS LOCATE LUBRICATOR AS CLOSE TO THE TOOL AS POSSIBLE. NEVER LOCATE A LUBRICATOR BETWEEN A COMPRESSOR AND FILTER REGULATOR, OR ON AN AIR SUPPLY LINE TO A PAINT GUN.

FOR ANY APPLICATION, USE SLEEVE-TYPE COUPLER

FOR WALL MOUNT ONLY, USE PUSH-TYPE COUPLER

COUPLERS AND PLUGS

BARB-TYPE HOSE FITTINGS

HOSE FITTINGS

AIR POWERED TIRE BUFFER



FILTERS, REGULATORS & LUBRICATORS

TRU-FLATE®



• Tru-Flate

Filter / Regulator Combinations (Piggyback)

Accurate pressure regulation with maximum water and dirt separation, provided in a single, compact unit. The filter significantly increases the life of expensive equipment, such as air line tools, valves, cylinders and motors. The regulator employs a solid piston, which resists rupture, cracking or tearing under pressure or high cycle rates. Combination Filter/Regulators have 2 gauge ports and come complete with filter element, pressure gauge and locking knob adjustment. Maximum pressure (polycarbonate bowls): 150 PSI at 125° F primary, 2 to 125 PSI secondary. Maximum pressure (metal bowls): 250 PSI at 175° F primary, 5 to 250 PSI secondary. Temperature range: -10° F to +175° F.

Part No.	Series	Quantity	Port	SCFM†	Drain Type	Microns	Capacity	Bowl Type	Height (in.)
24-243	Mini	2/master*	1/4"	13	Manual	5	1 oz.	Poly	5.7
24-244	Mini	1/box	1/4"	13	Automatic	5	1 oz.	Poly	6.1
24-201	Compact	1/box	1/4"	55	Manual	40	5 oz.	Poly	10.4
24-211	Compact	1/box	3/8"	65	Manual	40	5 oz.	Poly	10.4
24-221	Standard	1/box	1/2"	105	Manual	40	5 oz.	Poly	12.1
24-222	Standard	1/box	1/2"	105	Automatic	40	8 oz.	Poly	12.1
24-231	Standard	1/box	3/4"	110	Manual	40	8 oz.	Poly	12.1

*Retail clamshell package

†Standard cubic feet per minute with 100 PSI inlet pressure, 80 PSI no flow secondary setting and 10 PSI pressure drop.



Air Line Filters

Tru-Flate® Air Line Filters are used for all air line applications where efficient filtration is required. Filtration removes airborne solid contaminants, pipe scale, rust, condensate, etc., which may cause wear or failure of pneumatic components. Large filter element surface gives low pressure drop and long element life. The Mini series of air line filters offers a higher degree of filtration. All filters are complete with filter element and either manual or automatic drains. Maximum pressure: 150 PSI at 125° F with polycarbonate bowl and 250 PSI at 175° F with metal bowl. Temperature range: -10° F to +175° F.

Part No.	Series	Quantity	Port	SCFM†	Drain Type	Microns	Capacity	Bowl Type	Height (in.)
24-343	Mini	2/master*	1/4"	21	Manual	5	1 oz.	Poly	4.4
24-301	Compact	2/master*	1/4"	50	Manual	40	5 oz.	Poly	6.1
24-311	Compact	2/master*	3/8"	75	Manual	40	5 oz.	Poly	6.1
24-321	Standard	1/box	1/2"	110	Manual	40	8 oz.	Poly	7.7
24-322	Standard	1/box	1/2"	110	Automatic	40	8 oz.	Poly	7.7
24-331	Standard	1/box	3/4"	125	Manual	40	8 oz.	Poly	7.7
24-351	Hi-Flow	1/box	1"	300	Manual	40	18 oz.	Metal	11.0

*Retail clamshell package

†Standard cubic feet per minute with 100 PSI inlet pressure with 5 PSI pressure drop.

FILTERS, REGULATORS & LUBRICATORS

TRU-FLATE®

• Tru-Flate

Air Line Regulators

Tru-Flate® Air Line Regulators employ a solid piston and balanced poppet for excellent performance and longer life. The solid piston design is reliable for a broad range of demanding applications and is impervious to a wide range of lubricating oils and greases. Unlike diaphragms, the solid piston resists rupture, cracking or tearing under pressure, constant flexing or high cycle rates. It is impervious to most chemicals, provides accurate control and assures smooth, uninterrupted operation. Tru-Flate Air Line Regulators have fast reverse flow capabilities, allowing installation where dual pressures are required. Feature 2 gauge ports and include pressure gauge and non-rising, locking knob adjustment. Maximum pressure: 250 PSI primary, 2 to 125 PSI secondary.

Part No.	Series	Quantity	Port	SCFM†	Height (in.)
24-444	Mini	2/master*	1/4"	13	2.9
24-404	Compact	2/master*	1/4"	55	6.4
24-414	Compact	2/master*	3/8"	70	6.4
24-424	Standard	1/box	1/2"	110	7.3
24-434	Standard	1/box	3/4"	130	7.3
24-454	Hi-Flow	1/box	1"	300	8.5

*Retail clamshell package

†Standard cubic feet per minute with 100 PSI inlet pressure with 5 PSI pressure drop.

Air Line Lubricators

Tru-Flate Air Line Lubricators are designed to provide proportional delivery of lubricating oil over a wide range of air flows. Ideal for most general applications. Externally adjustable with transparent sight dome for 360° visibility. Lubricator should be mounted as close as possible to application to ensure most effective distribution of oil to pneumatic components. Suggested lubricant: Petroleum-based oil of 100 to 200 SSU viscosity at 100° F and an aniline point greater than 200° F.

Except for the Mini series, Tru-Flate Air Line Lubricators may be filled while the system is under pressure. Maximum pressure: 150 PSI at 125° F with polycarbonate bowl. Temperature range: -10° F to +175° F. For pressures up to 250 PSI at 175° F, a metal replacement bowl must be ordered and installed separately. Metal bowls with sight glass are standard for the Hi-Flow Series.

Part No.	Series	Quantity	Port	SCFM†	Height (in.)	Bowl Type	Height (in.)
24-542	Mini	1/box	1/4"	11	1 oz.	Poly	5.2
24-501	Compact	1/box	1/4"	20	5 oz.	Poly	7.4
24-511	Compact	1/box	3/8"	35	5 oz.	Poly	7.4
24-521	Standard	1/box	1/2"	85	8 oz.	Poly	8.9
24-531	Standard	1/box	3/4"	90	8 oz.	Poly	8.9
24-551	Hi-Flow	1/box	1"	260	18 oz.	Metal	11.8

Warning: Oils with adhesives, compounded oils containing solvents, graphite, detergents or synthetic oils must not be used.

†Standard cubic feet per minute at 10 PSI with 5 PSI pressure drop.



FILTERS, REGULATORS & LUBRICATORS

TRU-FLATE®



56-081



56-082



24-807
24-811



24-801
24-803
24-804

• Tru-Flate

Dessicant Dryers

Our in-line dessicant dryers are engineered to deliver extremely dry compressed air to protect pneumatically operated equipment from the adverse effects of moisture. Maximum rated operating conditions – Metal bowl with sight glass: 250 PSIG (17.2 Bar); 120F (48C).

Part No.	Port	Bowl	Flow Rate Max.	Pressure	Quantity
56-081	1/2"	1 qt.	10 SCFM†	300 PSI	1/box

†Standard cubic feet per minute with 100 PSI inlet pressure with 5 PSI pressure drop.

WARNING: These dryers are intended for use in compressed air systems only. Do not use where pressure or temperature may exceed maximum rated operating conditions. These units are not to be used on life support systems or breathing air systems. Failure to follow the recommendations contained in this warning may result in personal injury and/or property damage.

56-082 Replacement Beads. 1 qt.

Air Line Pressure Gauges

Pressed steel case with shatterproof crystal and brass fitting. Used for air, water, oil, or other fluids compatible with brass and bronze. Nominal accuracy 3–2–3%.

Part No.	Mount	Quantity	Thread	PSI Range
24-801	Back	1/master*	1/8" NPT	0–200
24-803	Back	1/master*	1/4" NPT	0–160
24-804	Back	1/master*	1/4" NPT	0–300
24-807	Bottom	1/box	1/4" NPT	0–160
24-811	Bottom	1/box	1/4" NPT	0–300

*Retail clamshell package

FILTERS, REGULATORS & LUBRICATORS

TRU-FLATE®

• Tru-Flate

Replacement Parts and Accessories

Each sold individually, either boxed or in retail bags.

Product	Mini	Compact	Standard	Hi-Flow
Filter Element Kits Includes one element and all necessary O-ring seals.				
40 Micron	–	24-932	24-939	24-930
20 SCFM (rated)	–	–	24-943	–
Polycarbonate Bowls	–	24-901	24-902	–
Metal Bowls	–	24-903	24-910	–
Polyethylene Bowl Guard Kit For applications where polycarbonate bowls may be subjected to impact or rougher than normal usages.	–		24-912	–
Automatic Float Drain Kit	–	24-920	24-920	24-920
Mounting Brackets Kits are designed to permit wall mounting of Compact, Standard and Hi-Flow Series Filters and Regulators.				
Lubricators & Filters	24-950	24-956	24-957	24-958
Regulators & Piggyback	24-950	–	24-955	24-958



Mounting Bracket



Automatic Float Drain



Bowl Guard



Filter Element Kit



Polycarbonate Bowl



Metal Bowl

IN-LINE AIR TOOLS

TRU-FLATE® Amflö®



41-101



41-135



41-145



- Tru-Flate • Amflo

In-Line Air Tool Oiler

A compact oiler that fastens directly to the air tool. Precisely meters proper amount of oil to the tool only when the tool is in use. No adjustments necessary. 1/4" male NPT outlet, 1/4" female NPT inlet. Use on all air impact guns, air wrenches, body shop air tools and pneumatic hammers requiring 1/4" air lines. Note: Never use motor oil in pneumatic tool. **Prevents "burn-out" of expensive pneumatic tools, stops rust and increases torque up to 25%.**

41-101 Carded. 10/master.

In-Line Air Flow Regulator

Controls in-line air pressure for paint spray guns or other pneumatic tools. Helps keep air flow at exact operating pressures. Use where precise air flow is desired. Compact, lightweight design with gauge, allows for easy "on the tool" air adjustment.

41-135 Carded. 5/master. 0-160 PSI

At-Hand® In-Line Air Tool Regulator

Controls in-line air pressure for paint spray guns or other pneumatic tools. Helps keep air flow at exact operating pressures. Use where precise air flow is desired. Compact, lightweight design with gauge, allows for easy "on the tool" air adjustment.

41-143 Clamshell. 5/master. Low pressure 10-60 PSI

41-145 Clamshell. 5/master. High pressure 40-140 PSI

Control air pressure right at the tool!



Having to adjust the pressure at the compressor is a THING OF THE PAST!

Rotate to desired PSI, then lock that setting

• Tru-Flate • Amflo

Air Regulator with Gauge

Regulates air pressure from compressor to match the recommended air pressure required by air tool. 1/4" female NPT inlet/outlet ports. Install at any angle.

41-155 Clamshell. 5/master. High pressure 200 PSI

Tamperproof In-Line Regulator

Tamperproof fixed pressure setting preset at the factory – can be installed with safety in mind. Balanced poppet design will not chatter or drift, so outlet setting will not change even when inlet pressure varies. High flow capability can be restricted for low flow requirements. Streamlined low-profile shape for neat installation and space saving requirements. Easy to install, no brackets or special tools required. Regulator will function in any position. High-strength aluminum alloy construction, anodized for corrosion protection and color coded.

1/4" NPTF. Regulator inlet rating 400 PSI. Unit only delivers line pressure. Delivery pressure is a function of flow.

2112 90 PSI. Red band. 1/box.

2113 100 PSI. Silver band. 1/box.

2114 110 PSI. Brass band. 1/box.

In-Line Air Tool Filter

A compact and extremely effective accessory for all air-operated shop tools and equipment, such as inflator gauges, impact wrenches, spray guns, air powered sanders, etc. Protects them against rust, pipe scale and dirt. 1/4" female NPT inlet, 1/4" male NPT outlet. Sintered bronze filter element.

Maximum working pressure 500 PSI. **Reduces downtime, prevents expensive repairs and prolongs the life of pneumatic tools.**

41-150 Carded. 10/master.

In-Line Dessiccant Dryer

The In-Line Desiccant Filter/Dryer removes dirt, dust, water and oil from air lines by using a non-toxic, moisture-absorbing silica gel to filter contaminants. Easily installs on any 1/4" NPT air system and is rated up to 125 PSI.

41-103 Carded. 4/master.



41-155



41-150



41-103

FILTERS, REGULATORS & LUBRICATORS

Amflo



Mini*



Compact



Standard

• Amflo

Filter / Regulator Combinations (Piggyback)

Accurate pressure regulation with maximum water and dirt separation, provided in a single, compact unit. The filter significantly increases the life of expensive equipment, such as air line tools, valves, cylinders and motors. The regulator employs a solid piston, which resists rupture, cracking or tearing under pressure or high cycle rates. Combination Filter/Regulators have 2 gauge ports and come complete with filter element and locking knob adjustment. Maximum pressure (polycarbonate bowls): 150 PSI at 125° F primary, 5 to 125 PSI secondary. Maximum pressure (metal bowls): 250 PSI at 175° F primary, 5 to 250 PSI secondary. Temperature range: -10° F to +175° F.

Part No.	Series	Quantity	Port	SCFM†	Capacity	Bowl Type
4300	Mini*	1/box	1/4"	20	1 oz.	Poly
4310A-99	Compact	1/box	1/4"	75	5 oz.	Poly
4320A-99	Compact	1/box	3/8"	75	5 oz.	Poly
4330	Standard	1/box	1/2"	150	8 oz.	Poly w/ Metal Guard
4331	Standard	1/box	1/2"	150	8 oz.	Metal
4340	Standard	1/box	3/4"	150	8 oz.	Poly w/ Metal Guard
4341	Standard	1/box	3/4"	150	8 oz.	Metal

†Standard cubic feet per minute with 100 PSI inlet pressure, 80 PSI no flow secondary setting and 10 PSI pressure drop.

Air Line Filters

Amflo® Air Line Filters are used for all air line applications where efficient filtration is required. Filtration removes airborne solid contaminants, pipe scale, rust, condensate, etc., which may cause wear or failure of pneumatic components. Large filter element surface gives low pressure drop and long element life. The Mini series of air line filters offers a higher degree of filtration. All filters are complete with filter element and either manual or automatic drains. Maximum pressure: 150 PSI at 125° F with polycarbonate bowl and 250 PSI at 175° F with metal bowl. Temperature range: -10° F to +175° F.



Compact



Standard



Hi-Flow

Part No.	Series	Quantity	Port	SCFM†	Drain Type	Microns	Capacity	Bowl Type
4010A-99	Compact	1/box	1/4"	21	Manual	40	5 oz.	Poly
4011A-99	Compact	1/box	1/4"	21	Manual	40	5 oz.	Metal
4020A-99	Compact	1/box	3/8"	70	Manual	40	5 oz.	Poly
4021A-99	Compact	1/box	3/8"	70	Manual	40	5 oz.	Metal
4030	Standard	1/box	1/2"	150	Manual	40	8 oz.	Poly
4031	Standard	1/box	1/2"	150	Manual	40	8 oz.	Metal
4032	Standard	1/box	3/4"	150	Manual	40	8 oz.	Poly
4040	Standard	1/box	3/4"	150	Manual	40	8 oz.	Metal
4041	Hi-Flow	1/box	3/4"	425	Manual	40	8 oz.	Metal
4050	Hi-Flow	1/box	1"	425	Manual	40	8 oz.	Metal

†Standard cubic feet per minute with 100 PSI inlet pressure, 80 PSI no flow secondary setting and 10 PSI pressure drop.

FILTERS, REGULATORS & LUBRICATORS



• Amflo

Air Line Regulators

Amflo® Air Line Regulators employ a solid piston and balanced poppet for excellent performance and longer life. The solid piston design is reliable for a broad range of demanding applications and is impervious to a wide range of oils and greases. Amflo Air Line Regulators have fast reverse flow capabilities, allowing installation where dual pressures are required. Maximum inlet pressure: 300 PSI. Temperature range: 0° F to +150° F (Mini and Compact), 0° F to +175° F (Standard). Gauge not included.

Part No.	Series	Quantity	Port	SCFM†
4100	Mini	1/box	1/4"	20
4100D	Mini	1/master*	1/4"	20
4115A-99	Compact	1/box	1/4"	70
4125A-99	Compact	1/box	3/8"	70
4135	Standard	1/box	1/2"	150
4145	Standard	1/box	3/4"	150
4141	Standard	1/box	3/4"	150
4155	Hi-Flow	1/box	1"	425

*Retail display package.

†Standard cubic feet per minute with 100 PSI inlet pressure, 80 PSI no flow secondary setting and 10 PSI pressure drop.

Air Line Lubricators – Micro Fog

Amflo® Air Line Lubricators are designed to provide proportional delivery of lubricating oil over a wide range of air flows and are ideal for most general applications. Micro Fog has droplet size of less than 2 microns, has finer control and the oil will travel greater distances. Lubricator is externally adjustable with a transparent sight dome for 360° visibility. Maximum pressure: 150 PSI at 125° F with polycarbonate bowl, 250 PSI at 175° F with metal bowl.

Part No.	Series	Quantity	Port	SCFM†	Capacity	Bowl Type
4235	Standard	1/box	1/2"	150	8 oz.	Poly w/ Metal Guard

WARNING: Oils with adhesives, compounded oils containing solvents, graphite, detergents or synthetic oils must not be used.

†Standard cubic feet per minute at 10 PSI with 5 PSI pressure drop.



Mini



Compact



Standard



Standard

FILTERS, REGULATORS & LUBRICATORS

Amflo



Standard
(Poly Bowl)



Standard
(Metal Bowl)



Standard



Bottom Mount
Gauge



Back Mount
Gauge

• Amflo

Air Line Lubricators – Oil Fog

Amflo® Air Line Lubricators are designed to provide proportional delivery of lubricating oil over a wide range of air flows and are ideal for most general applications. Oil Fog has droplet size of greater than 2 microns, for applications over short distances. Most can be filled while system is still under pressure. Maximum pressure: 150 PSI at 125° F with polycarbonate bowl, 250 PSI at 175° F with metal bowl.

Part No.	Series	Quantity	Port	SCFM†	Capacity	Bowl Type
4210A-99	Compact	1/box	1/4"	35	5 oz.	Poly
4211A-99	Compact	1/box	1/4"	35	5 oz.	Metal
4220A-99	Compact	1/box	3/8"	35	5 oz.	Poly
4230	Standard	1/box	1/2"	150	8 oz.	Poly w/ Metal Guard
4241	Standard	1/box	3/4"	150	8 oz.	Metal

Warning: Oils with adhesives, compounded oils containing solvents, graphite, detergents or synthetic oils must not be used.

†Standard cubic feet per minute at 10 PSI with 5 PSI pressure drop.

FRL Combo Units

The function of a Filter, Regulator and Lubricator in one convenient unit. Maximum pressure: 250 PSI at 175° F with metal bowl.

Part No.	Series	Quantity	Port	SCFM†	Capacity	Bowl Type
4431	Standard	1/box	1/2"	150	8 oz.	Metal

Air Line Pressure Gauges

Pressed steel case with shatterproof crystal and brass fitting. Used for air, water, oil, or other fluids compatible with brass and bronze. Nominal accuracy 3–2–3%.

Part No.	Mount	Quantity	Thread	PSI Range
1012-15	Bottom	1/box	1/4" NPT	0-15
1012-160	Bottom	1/box	1/4" NPT	0-160
1101-60	Back	1/box	1/8" NPT	0-60
1101-160	Back	1/box	1/8" NPT	0-160
1112-160	Back	1/box	1/4" NPT	0-160
1112-300	Back	1/box	1/4" NPT	0-300

*Retail display package.

FILTERS, REGULATORS & LUBRICATORS

Amflo

• Amflo

Replacement Parts and Accessories

Filter Element Kits

- 3063** 3/8" Mini Filter Element Kit, 5 micron. 1/bag.
- 4093** 1/2" Standard Filter Element, 40 micron. 1/bag.
- 4068** 1" Standard Filter Element, 40 micron. 1/bag.

Drain Kits

- 4060** Automatic Drain. 1/bag.
- 4070** 3/8" Automatic Drain. 1/bag.
- 4096** Manual Drain Kit. 1/bag.
- 4085** Manual Drain Repair Kit, T-Handle Type. 1/bag.

Repair Kits

- 4776** 1/2" Regulator Repair Kit. 1/bag.

Replacement Bowls

- 4074A-99** 3/8" Polycarbonate Bowl. 1/box.
- 4095** 1/2" Polycarbonate Bowl. 1/box.
- 4264** Mini Polycarbonate Bowl, for Lubricator. 1/box.
- 4265A-99** 3/8" Polycarbonate Bowl, for Lubricator. 1/box.
- 4270A-99** 3/8" Metal Bowl, for Lubricator. 1/box.

Bowl O-Rings

- 4780** Mini Bowl O-Ring. 1/bag.
- 4782** 3/8" Bowl O-Ring. 1/bag.
- 4783** 1/2" Bowl O-Ring. 1/bag.

Panel Nuts

- 4161** Mini Regulator Panel Nut. 1/bag.
- 4773** Zinc Panel Mount Nut. 1/bag.
- 4778** 3/8" Panel Nut. 1/bag.

Replacement Domes

- 4282** Adjustment Dome, Oil Fog Lubricators. 1/box.

Mounting Brackets

- 4071A-99** 3/8" Mounting Bracket. 1/bag.
- 3162** 3/8" Mounting Bracket. 1/bag.
- 4160** Mini Mounting Bracket. 1/bag.
- 4165** 1" Mounting Bracket. 1/bag.
- 4760** Universal Wall Bracket for 1/4" Compact Series. 1/bag.
- 4772** Universal Wall Bracket for 1/2" Modular Series. 1/bag.

Quick-Clamps

- 4769** Quick-Clamp for 1/2" Modular Series. 1/bag.
- 4771** Quick-Clamp with Wall Bracket for 1/2" Modular Series. 1/bag.



Filter Element Kit



Drain Kits



Regulator Repair Kit



Bowl O-Ring



Panel Nut



Polycarbonate Bowl

Metal Bowl



Replacement Dome



Quick-Clamp



Mounting Brackets

AIR ACCESSORIES

TRU-FLATE® Amflo®



1220-1

1220-8

1420



1304



235



240



556

2755



6116

• Tru-Flate • Amflo

Lubricants

92 SUS at 75° F. Air Tool Oil is silicone-free.

- 1220-1 Air Tool Oil. 1 pint bottle. 12/master.
- 1220-4 Air Tool Oil. 4 oz. bottle (not shown). 12/master.
- 1220-8 Air Tool Oil. 1 gallon bottle. 4/master.
- 1420 Compressor Oil. 1 quart bottle. 12/master.

Ball Valves

For all commercial and general industrial applications. Pressure rating 600 PSI, steam rating 150 WP, temperature range -20°F to 370°F.

- 1304 1/2" FNPT. 1/box.

Specialty Valves

For air tanks, steel barrels, compressors and other pneumatic containers where dependable automatic air valves are needed.

Throttle Valve

Controls air flow from near shut-off to full flow. Knurled knob is graduated. Spring-loaded ball and detent hold setting. Solid brass construction.

- 235 1/4" NPT. 1/box.

Two-Way Lever Valve

Chrome plated die-cast body. Buna-N seals for air and water.

- 240 1/4" FNPT. 1/box.
- 240-100 1/4" FNPT. Bulk. 100/box.

High Pressure Inflating Connections

These high-pressure inflating connections attach securely by hand or wrench to the valve cap threads of high pressure valves. Can be fitted to gauging and inflating devices by a variety of methods. Various angles permit easy attachment to hard-to-reach valves. Pressure rating 3,000 PSI.

- 2755 For 3/16" flare tube. 3/8"-24 thread. 1/box.
- 556 90° angle. Copper sealing washer. 1/8" MNPT. 1/box.
- 6116 70° angle. Hard fiber sealing washer. 1/8" FNPT. 10/box.

WARNING: Valves on this page are intended for compressed air lines or water lines only. All have a maximum rated pressure of 300 PSI unless otherwise noted.

• Tru-Flate • Amflo

Tank Valves

For air tanks, steel barrels, compressors and other pneumatic containers where dependable automatic air valves are needed. Equipped with standard valve core and sealing caps for operating pressures to 200 PSI. Allow for external length variations by use of short core only or internal protrusion of core housing into container.

- 38-906** 1/8" MNPT. Carded. 10/master.
- 700-100** 1/8" MNPT. Bulk. 100/box.
- 38-900** 1/8" MNPT, long. Carded. 5/master.
- 38-900-10** 1/8" MNPT, long. 10/box.
- 701-2** 1/4" MNPT. 10/box.
- 701-2-100** 1/4" MNPT. Bulk. 100/box.
- 701-42** 1/8" Hose Barb. 25/box.
- 1468L-6** 1/4" MNPT. Bulk. 100/box.
- 1498L-6** 1/4" MNPT. 25/box.
- 9166L-8** 1/8" MNPT. 10/box.
- 645L-6** 1/8" MNPT. 10/box.

Bleeder Valves

Simple push-button for bleeding compressed air lines or liquid systems.

- 710-100** .310-32 thread. Bulk. 100/box.
- 711** 1/8" MNPT. 10/box.
- 711-100** 1/8" MNPT. Bulk. 100/box.

Driveway Signal Bell

Bell rings when auto tire passes over the hose. Easy to install and wire.

Driveway signal bell. 110 volt. 3 wire ground cord.

- 880** 1/box.

Hose anchor and plug. For 3/8" ID Signal Hose.

- 880N** 1/box.

Bicycle Pump Fittings

Screw-on swivel chuck for most hand-operated tire pumps.

- 705** 3/16" ID. 10/box.
- 705-100** 3/16" ID. Bulk. 100/box.
- 706** 1/4" ID. 10/box.
- 706-100** 1/4" ID. Bulk. 100/box.

Compressor Repair Parts

Air Tank Conversion Kit. Includes gauge, manifold and hose with fittings.

- 41-907** Carded. 5/master.
- 54-516** Replacement Hose with Fittings. Length 48" 1/box.
- 54-517** Replacement Manifold. 1/box.



AIR ACCESSORIES

TRU-FLATE® Amflö®



41-175



41-225



41-253

• Tru-Flate • Amflo

Compressor Accessory Kits

19 PC Air Accessory Kit

Perfect for the do-it-yourselfer! 19-piece kit contains all accessories needed to connect and use a tank-mounted air compressor.

- 1/M 1/4" Couplers/Plugs for air line hose and air tool connections
- Air Line Chuck for filling tire valves
- 50 PSI Tire Gauge, to check air pressure
- Blowgun Kit with multiple nozzles for general cleaning and drying
- Ball and tapered nozzles for inflating toys and recreational equipment

41-175 Carded. 5/master.

20 PC Air Accessory Kit

Perfect for the do-it-yourselfer! 20-piece kit contains all accessories needed to connect and use a tank-mounted air compressor.

- 1/M 1/4" Couplers/Plugs for air line hose and air tool connections
- Ball Foot Chuck & Dual Foot Chuck for filling tire valves
- 50 PSI Tire Gauge, to check air pressure
- Thread Seal Tape
- Blowgun Kit with multiple nozzles for general cleaning and drying
- Ball and tapered nozzles for inflating toys and recreational equipment
- Complete with storage box for added convenience

41-225 Boxed. 4/master.

15 PC Air Accessory Kit

Perfect for the do-it-yourselfer! 15-piece kit includes high quality recoil air hose and colored couplers and plugs for use with a tank-mounted air compressor.

- Tru-Match® couplers and plugs
- 23' x 1/4" Poly recoil hose works great in cold weather
- Dial tire gauge
- Blowgun Kit with multiple nozzles for general cleaning and drying
- Ball and tapered nozzles for inflating toys and recreational equipment
- Complete with storage box for added convenience

41-253 Boxed. 4/master.

• Tru-Flate • Amflo

Water / Radiator Valves

Features chrome plated bodies with brass internal parts and self-adjusting U-cup packing. Handles are riveted and spouts are reinforced for long life. Lever controlled operating valve. Alkali, heat, oil and weather resistant.

Water Nozzle.

43W 1/box.

Radiator Faucet. Aluminum. 1/4" FNPT.

40 1/box.

Radiator Filler. Rubber Nozzle. 3/4" Female Garden Bibb.

18-504 1/box.

Radiator Faucet. Rubber Nozzle. 1/4" FNPT

18-506 1/box.

40RD Display Pack. 1/box.

40R 1/box.

40R-100 Bulk. 50/box.

Mist Coolant

Specially formulated for all metals, including aluminum. Cools and lubricates, inhibits rust. Contains no nitrites.

270A Mist Coolant Unit. 1/box.

5 Piece Cut Off Discs

Includes (5) 3" x 1/16" thick cutting discs with 3/8" arbor hole designed for cutting through metal, fiberglass, plastics and steel piping. Discs are designed to be used with air powered cut-off tools and are rated to 25,000 RPM.

25-311 Carded. 6/master.

4 Piece Chisel Set

Set of 4 chisels can be used for ripping sheet metal or cutting through bolts, screws and nails. Chisels are made from heat-treated alloy steel for more strength and longer life.

25-310 Carded. 4/master.

10 Piece Surface Prep Kit

Contains (3) 40-grit and (3) 60-grit sanding disks, (1) fine finish and (1) medium finish surface prep pad, (1) back-up pad and (1) 1/4 in. mandrel. Mandrel easily fits into standard 1/4" die grinders.

25-319 Carded. 6/master.



HOSE CRIMPERS & FERRULES

TRU-FLATE® Amflo®



855



856



7325



7329



7333

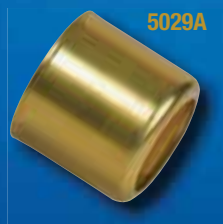

5029A

• Tru-Flate • Amflo

Standard Hose Crimper

Provides production capabilities and "big tool" crimping advantages at a much lower cost. Heavy duty ductile iron castings and hardened steel dies provide long service life and positive crimping. Includes five dies for crimping 1/4" braid to 3/8" double-braided hose. Also works on steel-braided hose.

855 1/box.

Replacement Dies for Hose Crimper

Sizes indicated (*) are included with Hose Crimper above. 1/bag.

856-1*	5/8"	(.6250)
856-8	3/4"	(.7500)
856-9	13/16"	(.8125)

Brass Ferrules

Use with hose barb fittings. Make sure ferrule closely matches hose O.D. For use with Amflo Hose Crimper 855.

7321-50	.478" ID ferrule.	50/box.
7322-50	.500" ID ferrule.	50/box.
7323-50	.525" ID ferrule.	50/box.
7325-50	.562" ID ferrule.	50/box.
7326-50	.593" ID ferrule.	50/box.
7327-50	.625" ID ferrule.	50/box.
7328-50	.656" ID ferrule.	50/box.
7329-50	.687" ID ferrule.	50/box.
7330-50	.718" ID ferrule.	50/box.
7331-50	.750" ID ferrule.	50/box.
7332-50	.781" ID ferrule.	50/box.
7333-50	.812" ID ferrule.	50/box.
7334-50	.825" ID ferrule.	50/box.
7335-50	.850" ID ferrule.	50/box.
5029A-50	.900" ID ferrule.	50/box.
7242A-50	.937" ID ferrule.	50/box.

WARNING: The products on this page are designed for use on compressed air lines only. Select fitting to match hose diameter. Fittings must be secured with the proper size crimped-on ferrule. Do not exceed the pressure limitation of the hose and/or air operated devices being used. Failure to follow these directions exactly may cause fittings to separate from hose and may result in personal injury and/or property damage.

MERCHANDISERS / DISPLAYS

TRU-FLATE® Amflö®

Tru-Flate® packaging combines colorful, eye-catching graphics and essential "how-to-use" information for added value to customers.

Tru-Flate displays are versatile, with interchangeable headers, moveable hooks and pre-printed back-up cards.

96-630 Includes 96-630-02 and 96-630-03.

Purchase both panels for the widest, most complete range of couplers, plugs, chucks, fittings and gauges or order a single panel for key products.

Couplers & Plugs

96-630-02

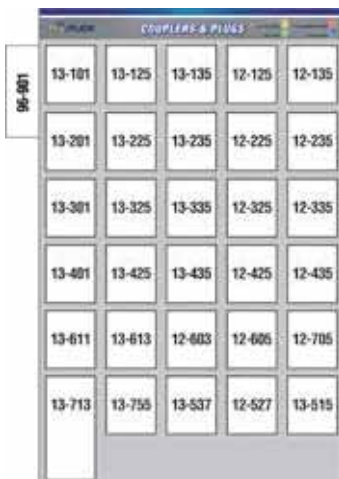

Most popular sizes of Tru-Flate, Lincoln, I/M, and Aro couplers and plugs.

Part #	Qty.	Description
13-101	2	COUPLER/NIPPLE SET, 1/4" T-F
13-125	2	COUPLER, 1/4" T-F, 1/4" MNPT
13-135	2	COUPLER, 1/4" T-F, 1/4" FNPT
12-125	2	NIPPLE, 1/4" T-F, 1/4" MNPT
12-135	2	NIPPLE, 1/4" T-F, 1/4" FNPT
13-201	2	COUPLER/NIPPLE SET, 1/4" I/M
13-225	2	COUPLER, 1/4" I/M, 1/4" MNPT
13-235	2	COUPLER, 1/4" I/M, 1/4" FNPT
12-225	2	NIPPLE, 1/4" I/M, 1/4" MNPT
12-235	2	NIPPLE, 1/4" I/M, 1/4" FNPT
13-301	2	COUPLER/NIPPLE SET, 1/4" ARO
13-325	2	COUPLER, 1/4" ARO, 1/4" MNPT
13-335	2	COUPLER, 1/4" ARO, 1/4" FNPT
12-325	2	NIPPLE, 1/4" ARO, 1/4" MNPT
12-335	2	NIPPLE, 1/4" ARO, 1/4" FNPT
13-401	2	COUPLER/NIPPLE SET, 1/4" LINCOLN
13-425	2	COUPLER, 1/4" LINCOLN, 1/4" MNPT
13-435	2	COUPLER, 1/4" LINCOLN, 1/4" FNPT
12-425	2	NIPPLE, 1/4" LINCOLN, 1/4" MNPT
12-435	2	NIPPLE, 1/4" LINCOLN, 1/4" FNPT
13-611	2	COUPLER, 3/8" T-F, 1/4" FNPT
13-613	2	COUPLER, 3/8" T-F, 3/8" FNPT
12-603	2	NIPPLE, 3/8" T-F, 1/4" MNPT
12-605	2	NIPPLE, 3/8" T-F, 3/8" MNPT
12-705	2	NIPPLE, 1/2" T-F, 1/2" MNPT
13-713	2	COUPLER, 3/8" T-F, 1/2" FNPT
13-755	2	PUSH COUPLER, 1/4" I/M, 1/4"
13-537	2	COUPLER, 3/8" I/M, 3/8" FNPT
12-527	2	NIPPLE, 3/8" I/M, 3/8" MNPT
13-515	1	COMBO COUPLER, 1/4" FNPT
96-901	1	COUPLER TEST BAR

Blowguns, Chucks & Fittings

96-630-03

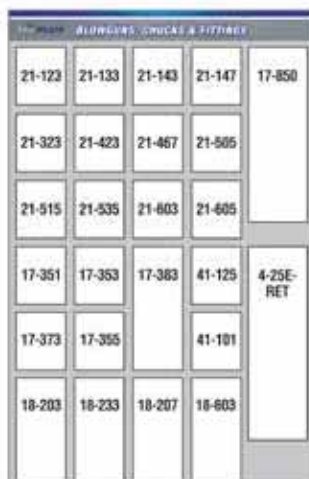

Most popular air hose fittings, chucks, and blowguns.

Part #	Qty.	Description
21-123	2	FITTING, BARB, 1/4" ID x 1/4" MNPT
21-133	2	FITTING, BARB, 5/16" ID x 1/4" MNPT
21-143	2	FITTING, BARB, 3/8" ID x 1/4" MNPT
21-147	2	FITTING, BARB, 3/8" ID x 3/8" MNPT
17-850	2	GAUGE, INFLATOR-DELUXE
21-323	2	FITTING, HOSE-SWIVEL, FEMALE
21-423	2	HOSE SPLICER, 1/4" ID
21-467	2	HOSE SPLICER, 3/8" ID
21-505	2	COUPLING, 1/4" MNPT x 1/4" MNPT
21-515	2	COUPLING, 1/4" FNPT x 1/4" FNPT
21-535	2	BUSHING, 1/4" FNPT x 3/8" MNPT
21-603	2	AIRLINE SWIVEL, 1/4" MNPT x 3/8"
21-605	2	AIR SWIVEL, 1/4" MNPT x 1/4" FNPT
17-351	2	CHUCK, DIRECT AIRLINE
17-353	2	CHUCK, DIRECT AIRLINE W/CLIP
17-383	2	CHUCK, DIRECT AIRLINE, DUAL FOOT
41-125	2	AIRLINE MANIFOLD, 3-IN-ONE, 1/4"
17-373	2	CHUCK, GRIP-TITE
17-355	2	CHUCK, SNAP-ON W/CLIP
41-101	2	IN-LINE TOOL OILER
4-25E-RET	2	HOSE W/FTGS, 25"-FAST STORE
18-203	2	BLOWGUN, STANDARD-LEVER
18-233	2	BLOWGUN, SAFETY-LEVER
18-207	2	BLOWGUN, STANDARD-RUBBER TIP
18-603	2	BLOWGUN, ADJUSTABLE I/M

MERCHANDISERS / DISPLAYS

TRU-FLATE Amflö

4-Panel Display

96-650 Tru-Flate's most popular air line accessories and tire hardware conveniently mounted on 4 display panels. Free standing display swivels for space efficiency, easy product selection and restocking. Includes Coupler Test Bar for easy in-store identification of coupler and plug design style.

Couplers & Plugs

96-650-10 (Panel 1)



Part #	Qty.	Description
13-513	3	COMBO COUPLER, 1/4"MNPT
13-225	2	COUPLER, 1/4" I/M, 1/4"MNPT
13-235	3	COUPLER, 1/4" I/M, 1/4"FNPT
13-755	2	PUSH COUPLER, 1/4" I/M, 1/4"FNPT
13-537	1	COUPLER, 3/8" I/M, 3/8"FNPT
13-515	3	COMBO COUPLER, 1/4"FNPT
13-201	3	COUPLER/PLUG SET, 1/4" I/M
12-225	3	PLUG, 1/4" I/M, 1/4"MNPT
12-235	2	PLUG, 1/4" I/M, 1/4"FNPT
12-527	1	PLUG, 3/8" I/M, 3/8"MNPT
13-101	3	COUPLER/PLUG SET, 1/4" T-F
13-125	2	COUPLER, 1/4" T-F, 1/4"MNPT
13-135	3	COUPLER, 1/4" T-F, 1/4"FNPT
12-125	3	PLUG, 1/4" T-F, 1/4"MNPT
12-135	2	PLUG, 1/4" T-F, 1/4"FNPT
13-611	1	COUPLER, 3/8" T-F, 1/4"FNPT
13-613	1	COUPLER, 3/8" T-F, 3/8"FNPT
13-335	2	COUPLER, 1/4" ARO, 1/4"FNPT
12-325	3	PLUG, 1/4" ARO, 1/4"MNPT
12-335	2	PLUG, 1/4" ARO, 1/4"FNPT
12-603	1	PLUG, 3/8" T-F, 1/4"MNPT
12-605	1	PLUG, 3/8" T-F, 3/8"MNPT
13-435	2	COUPLER, 1/4" LINC, 1/4"MNPT
12-425	3	PLUG, 1/4" LINC, 1/4"MNPT
12-435	2	PLUG, 1/4" LINC, 1/4"FNPT
13-713	1	COUPLER, 1/2" T-F&I/M, 1/2"FNPT
12-705	1	PLUG, 1/2" T-F, 1/2"MNPT
13-107B	2	COLOR-CODED COUPLER/PLUG SET, 1/4" T-F
13-207R	2	COLOR-CODED COUPLER/PLUG SET, 1/4" I/M
13-307G	2	COLOR-CODED COUPLER/PLUG SET, 1/4" ARO
96-901	1	COUPLER TEST BAR

Blowguns & Tire Hardware

96-650-11 (Panel 2)



Part #	Qty.	Description
17-509	3	GAUGE, TIRE-STANDARD, 10-50 PSI
17-519	2	GAUGE, TIRE-TRUCK, 20-120 PSI
17-521	1	GAUGE, TIRE-LOW PRESSURE, 1-20 PSI
17-525	1	GAUGE, TIRE-TRUCK, DUAL FT 20-120 PSI
17-545	2	GAUGE, TIRE-DUAL FT SRVC, 10-150 PSI
17-527	2	GAUGE, TIRE-BICYCLE, 20-120 PSI
17-523	3	EASY REACH TIRE GAUGE, 10-50 PSI
18-247	2	BLOWGUN, PALM-STYLE KIT
17-582	1	GAUGE, TIRE-DIGITAL, 5-IN-1
17-551	2	GAUGE, TIRE-DIAL, 10-60 PSI
18-203	1	BLOWGUN, STANDARD-LEVER TYPE
18-207	2	BLOWGUN, STANDARD-RUBBER TIP
41-125	2	AIRLINE MANIFOLD, 3-IN-ONE, 1/4"
41-135	2	AIRLINE REGULATOR W/GAUGE
18-233	2	BLOWGUN, SAFETY, LEVER TYPE
18-237	1	BLOWGUN, SAFETY, TAMPER-PROOF
18-603	1	BLOWGUN, ADJUSTABLE, I/M

MERCHANDISERS / DISPLAYS

TRU-FLATE® Amflo®

4-Panel Display Cont.

96-650 Tru-Flate's most popular air line accessories and tire hardware conveniently mounted on 4 display panels. Free standing display swivels for space efficiency, easy product selection and restocking. Includes Coupler Test Bar for easy in-store identification of coupler and plug design style.

Chucks, Fittings & Gauges

96-650-12 (Panel 3)



Part #	Qty.	Description
17-351	2	CHUCK,BALL FOOT,DIRECT AIRLINE
17-353	2	CHUCK,BALL FOOT,DIRECT AIRLINE W/CLIP
17-383	2	CHUCK, DIRECT AIRLINE, DUAL FOOT
17-395	2	CHUCK,DUAL LOCKING STRAIGHT-ON
17-850	1	INFLATOR GAUGE, DUAL FOOT CHUCK
17-369	2	CHUCK, BALL FOOT, DIRECT, 1/4" MNPT
41-101	1	IN-LINE TOOL OILER
21-123	2	FITTING, BARB, 1/4" ID X 1/4" MNPT
21-133	2	FITTING, BARB, 5/16" ID X 1/4" MNPT
21-143	2	FITTING, BARB, 3/8" ID X 1/4" MNPT
21-147	2	FITTING, BARB, 3/8" ID X 3/8" MNPT
21-323	2	FITTING, SWIVEL, 1/4" ID X 1/4" FNPS
21-423	2	HOSE SPLICER, 1/4" ID
21-467	2	HOSE SPLICER, 3/8" ID
21-505	2	COUPLING, 1/4" MNPT X 1/4" MNPT
4-25E-RET	1	FAST STOR HOSE W/ FITTINGS, 25', 1/4"
21-515	2	COUPLING, 1/4" FNPT X 1/4" FNPT
21-535	2	BUSHING, 1/4" FNPT X 3/8" MNPT
21-557	2	DRAIN COCK, 1/4"
41-300	1	HOSE REPAIR KIT
21-605	2	AIRLINE SWIVEL, 1/4" MNPT X 1/4" FNPT
21-707	2	SAFETY VALVE, 1/4", 125 PSI

Tire Maintenance Center

96-650-13 (Panel 4)



Part #	Qty.	Description
38-505	2	PLASTIC VALVE CAP,VC8
38-600-4	2	SCREWDRIVER TYPE VALVE CAP,VC2
38-712-4	2	HEX VALVE CAP
38-772-4	2	DOME TYPE CAP,VC3
38-790-4	2	VALVE CORE,C-1
38-507	2	LONG PLASTIC VALVE CAP
38-510	2	GREEN NITROGEN VALVE CAP
38-900	2	TANK VALVE,1/8"MNPT
38-325-4	2	PLASTIC VALVE EXTENSION,1-1/4"
38-315-4	2	VALVE EXTENSION,1-1/4"
30-413-2	2	SNAP-IN VALVE,TR413
30-414-2	2	SNAP-IN VALVE,TR414
30-415-2	2	SNAP-IN VALVE,TR415
30-418-2	2	SNAP-IN VALVE,TR418
30-445	2	HIGH PERFORMANCE TIRE VALVE
30-316-4	2	CHROME VALVE SLEEVES,TR413
12-077	3	UNIVERSAL CEMENT,2 OZ
14-130	3	TUBE TIRE REPAIR KIT
15-165	3	RADIAL REPAIR KIT
15-169	3	PERMA-STRIP PATCH
41-067	2	TIRE VALVE REPAIR TOOL
14-134	3	FOIL BACK REPAIR KIT
17-236	2	YELLOW TIRE MARKING CRAYON
40-395	1	TREAD DEPTH GAUGE
41-466	1	VALVE FISHING TOOL
15-162	2	SUPER-GRIP TIRE REPAIR KIT

MERCHANDISERS / DISPLAYS

TRU-FLATE® Amflo®

Air Accessory Display

96-640

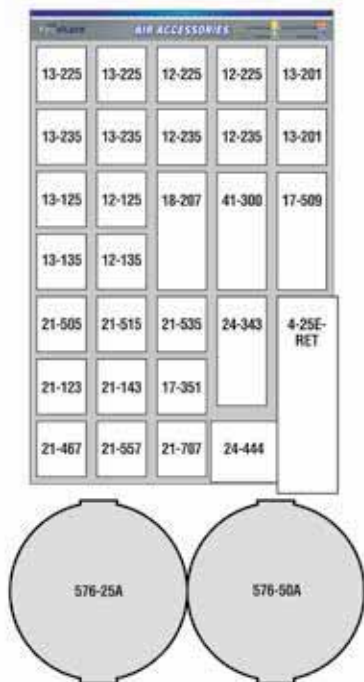

A one panel display that includes many of the top selling SKUs in the Tru-Flate® line, including 25' and 50' Amflo® PVC hoses.

Part #	Qty.	Description
13-225	6	COUPLER, 1/4" I/M, 1/4" MNPT
12-225	6	PLUG, 1/4" I/M, 1/4" MNPT
13-201	6	COUPLER/PLUG SET, 1/4" I/M
13-235	6	COUPLER, 1/4" I/M, 1/4" FNPT
12-235	6	PLUG, 1/4" I/M, 1/4" FNPT
13-125	4	COUPLER, 1/4" T-F, 1/4" MNPT
12-125	4	PLUG, 1/4" T-F, 1/4" MNPT
18-207	2	BLOWGUN, STANDARD-RUBBER TIP
41-300	2	HOSE REPAIR KIT
17-509	5	GAUGE, TIRE-STANDARD, 10-50 PSI
13-135	4	COUPLER, 1/4" T-F, 1/4" FNPT
12-135	4	PLUG, 1/4" T-F, 1/4" FNPT
21-505	2	COUPLING, 1/4" MNPT X 1/4" MNPT
21-515	2	COUPLING, 1/4" FNPT X 1/4" FNPT
21-535	2	BUSHING, 1/4" FNPT X 3/8" MNPT
24-343	1	FILTER, MINI
4-25E-RET	1	FAST STOR HOSE W/FITTINGS, 25', 1/4"
21-123	2	FITTING, BARB, 1/4" ID X 1/4" MNPT
21-143	2	FITTING, BARB, 3/8" ID X 1/4" MNPT
17-351	2	CHUCK, BALL FOOT, DIRECT AIRLINE
21-467	2	HOSE SPLICER, 3/8" ID
21-557	2	DRAIN COCK, 1/4"
21-707	2	SAFETY VALVE, 1/4", 125PSI
24-444	1	REGULATOR, MINI
576-25A	3	PVC HOSE 3/8"x25'w-1/4" FITTINGS, ORANGE
576-50A	3	PVC HOSE 3/8"x50'w-1/4" FITTINGS, ORANGE

Air Accessories

96-610-03



Covers all four common pneumatic coupler and plug designs, popular brass fittings and air line chucks, blowguns and coiled air hose.

Part #	Qty.	Description
13-101	3	COUPLER/PLUG SET, 1/4" T-F
12-125	3	PLUG, 1/4" T-F, 1/4" MNPT
13-135	3	COUPLER, 1/4" T-F, 1/4" FNPT
12-325	3	PLUG, 1/4" ARO, 1/4" MNPT
13-335	2	COUPLER, 1/4" ARO, 1/4" FNPT
13-201	3	COUPLER/PLUG SET, 1/4" I/M
12-225	3	PLUG, 1/4" I/M, 1/4" MNPT
13-235	3	COUPLER, 1/4" I/M, 1/4" FNPT
12-425	3	PLUG, 1/4" LINC, 1/4" MNPT
13-435	2	COUPLER, 1/4" LINC, 1/4" FNPT
17-351	2	CHUCK, BALL FOOT, DIRECT AIRLINE
21-123	2	FITTING, BARB, 1/4" ID X 1/4" MNPT
21-143	2	FITTING, BARB, 3/8" ID X 1/4" MNPT
21-423	2	HOSE SPLICER, 1/4" ID
4-25E-RET	1	FAST STOR HOSE W/ FITTINGS, 25', 1/4"
18-233	2	BLOWGUN, SAFETY, LEVER TYPE
18-203	1	BLOWGUN, STANDARD-LEVER TYPE
18-601	2	TRU-FLATE DESIGN ADJUSTABLE BLOWGUN
18-603	2	INDUSTRIAL/MILTON DESIGN ADJUSTABLE BLOWGUN
41-101	1	AIR TOOL OILER
41-300	2	AIR HOSE REPAIR KIT
17-383	3	DIRECT AIR LINE CHUCK
96-901	1	COUPLER TEST BAR

(Product only)

Can be purchased as part of a two-sided rack with popular tire repair products—part number 96-610.

Tru-Flate Part #	Description	Page
101TF	Inflator Gauge, Standard Duty, Dual Foot Chuck	30
12-124B	Plug, 1/4" TF, 1/4" MNPT, Orange, Bulk	20
12-125	Plug, 1/4" TF, 1/4" MNPT	20
12-125-2	Plug, 1/4" TF, 1/4" MNPT	20
12-134B	Plug, 1/4" TF, 1/4" FNPT, Orange, Bulk	20
12-135	Plug, 1/4" TF, 1/4" FNPT	20
12-135-2	Plug, 1/4" TF, 1/4" FNPT	20
12-223	Plug, 1/4" I/M X 1/4" MNPT, Swivel	16
12-224R	Plug, 1/4" I/M, 1/4" MNPT, Red, Bulk	16
12-225	Plug, 1/4" I/M, 1/4" MNPT	16
12-225-2	Plug, 1/4" I/M, 1/4" MNPT	16
12-227	Plug, 1/4" I/M, 3/8" MNPT	16
12-233	Plug, 1/4" I/M, 1/4" FNPT, Swivel	16
12-234R	Plug, 1/4" I/M, 1/4" FNPT, Red, Bulk	16
12-235	Plug, 1/4" I/M, 1/4" FNPT	16
12-235-2	Plug, 1/4" I/M, 1/4" FNPT	16
12-237	Plug, 1/4" I/M, 3/8" FNPT	16
12-324G	Plug, 1/4" ARO, 1/4" MNPT, Green, Bulk	24
12-325	Plug, 1/4" ARO, 1/4" MNPT	24
12-325-2	Plug, 1/4" ARO, 1/4" MNPT	24
12-334G	Plug, 1/4" ARO, 1/4" FNPT, Green, Bulk	24
12-335	Plug, 1/4" ARO, 1/4" FNPT	24
12-335-2	Plug, 1/4" ARO, 1/4" FNPT	24
12-425	Plug, 1/4" Linc, 1/4" MNPT	26
12-435	Plug, 1/4" Linc, 1/4" FNPT	26
12-523	Plug, 3/8" I/M 1/4" MNPT	18
12-527	Plug, 3/8" I/M, 3/8" MNPT	18
12-537	Plug, 3/8" I/M, 3/8" FNPT	18
12-603	Plug, 3/8" TF, 1/4" MNPT	22
12-603-2	Plug, 3/8" TF, 1/4" MNPT	22
12-605	Plug, 3/8" TF, 3/8" MNPT	22
12-611	Plug, 3/8" TF, 1/4" FNPT	22
12-613	Plug, 3/8" TF, 3/8" FNPT	22
12-705	Plug, 1/2" TF, 1/2" MNPT	23
12-713	Plug, 1/2" TF, 1/2" FNPT	23
12-924	Plug, 1/4" HI FLO, 1/4" MNPT, Bulk	26
12-925	Plug, 1/4" HI FLO, 1/4" MNPT, 2 Pack	26
12-929	Swivel Plug, 1/4" HI FLO, 1/4" MNPT	27
12-934	Plug, 1/4" HI FLO, 1/4" FNPT, Bulk	26

Tru-Flate Part #	Description	Page
12-935	Plug, 1/4" HI FLO, 1/4" FNPT, 2 Pack	26
13-101	Plug/Coupler Set, 1/4" TF, 1/4" NPT	21
13-107B	Plug/Coupler Set, 1/4" TF, 1/4" NPT, Orange, 3Pc	21
13-109B	Plug/Coupler Set, 1/4" TF, 1/4" NPT, Orange, 7Pc	21
13-111B	Plug/Coupler Set, 1/4" TF, 1/4" NPT, Orange, 14Pc	21
13-124B	Coupler, 1/4" Universal, 1/4" MNPT, Orange, Bulk	21
13-125	Coupler, 1/4" TF, 1/4" MNPT	21
13-134B	Coupler, 1/4" Universal, 1/4" FNPT, Orange, Bulk	21
13-135	Coupler, 1/4" TF, 1/4" FNPT	21
13-201	Plug/Coupler Set, 1/4" I/M, 1/4" NPT	18
13-203	Plug/Coupler Set, 1/4" I/M, 1/4" NPT	18
13-207R	Plug/Coupler Set, 1/4" I/M, 1/4" NPT, Red, 3Pc	18
13-209R	Plug/Coupler Set, 1/4" I/M, 1/4" NPT, Red, 7Pc	18
13-211R	Plug/Coupler Set, 1/4" I/M, 1/4" NPT, Red, 14Pc	18
13-224R	Coupler, 1/4" Universal, 1/4" MNPT, Red, Bulk	17
13-225	Coupler, 1/4" I/M, 1/4" MNPT	17
13-227	Coupler, 1/4" I/M, 3/8" MNPT	17
13-229	Coupler, 1/4" Safety, 1/4" MNPT, Black	29
13-234R	Coupler, 1/4" Universal, 1/4" FNPT, Red, Bulk	17
13-235	Coupler, 1/4" I/M, 1/4" FNPT	17
13-237	Coupler, 1/4" I/M, 3/8" FNPT	17
13-239	Coupler, 1/4" Safety, 1/4" FNPT, Black	29
13-301	Plug/Coupler Set, 1/4" ARO, 1/4" NPT	24
13-307G	Plug/Coupler Set, 1/4" ARO, 1/4" NPT, Green, 3Pc	24
13-309G	Plug/Coupler Set, 1/4" ARO, 1/4" NPT, Green, 7Pc	24
13-311G	Plug/Coupler Set, 1/4" ARO, 1/4" NPT, Green, 14Pc	24
13-324	Coupler, 1/4" ARO, 1/4" MNPT, Brass	25
13-324G	Coupler, 1/4" Universal, 1/4" MNPT, Green, Bulk	25
13-325	Coupler, 1/4" ARO, 1/4" MNPT, Brass	25
13-334	Coupler, 1/4" ARO, 1/4" FNPT	25
13-334-07	Coupler, 1/4" ARO, 1/4" FNPT, Bulk	25
13-334G	Coupler, 1/4" Universal, 1/4" FNPT, Green, Bulk	25
13-335	Coupler, 1/4" ARO, 1/4" FNPT	25
13-401	Plug/Coupler Set, 1/4" Linc, 1/4" NPT	26
13-424	Coupler, 1/4" Linc, 1/4" MNPT	26
13-425	Coupler, 1/4" Linc, 1/4" MNPT	26
13-434	Coupler, 1/4" Linc, 1/4" FNPT	26
13-435	Coupler, 1/4" Linc, 1/4" FNPT	26
13-512	Combo Coupler 1/4" MNPT, Bulk	29

Tru-Flate Part #	Description	Page
13-513	Combo Coupler 1/4 MNPT Carded	29
13-514	Combo Coupler 1/4 FNPT , Bulk	29
13-515	Combo Coupler 1/4 FNPT Carded	29
13-518	Coupler, Swivel, 1/4 FNPT Carded	29
13-527	Coupler, 3/8" I/M, 3/8" MNPT	19
13-537	Coupler, 3/8" I/M, 3/8" FNPT	19
13-603	Coupler, 3/8" TF, 1/4" MNPT	22
13-605	Coupler, 3/8" TF, 3/8" MNPT	22
13-611	Coupler 3/8" TF, 1/4" FNPT	22
13-613	Coupler, 3/8" TF, 3/8" FNPT	22
13-705	Coupler, 1/2" I/M, 1/2" MNPT	19,23
13-713	Coupler, 1/2" I/M, 1/2" FNPT	19,23
13-775	Push Coupler, 1/4" ARO, 1/4" FNPT	25
13-903	Plug/Coupler Set, 1/4" HI FLO, 1/4" NPT, 4Pc	27
13-907	Plug/Coupler Set, 1/4" HI FLO, 1/4" NPT, 10Pc	27
13-924	Coupler, 1/4" HI FLO, 1/4" MNPT , Bulk	27
13-925	Coupler, 1/4" HI FLO, 1/4" MNPT	27
13-934	Coupler, 1/4" HI FLO, 1/4" FNPT , Bulk	27
13-935	Coupler, 1/4" HI FLO, 1/4" FNPT	27
17-351	Chuck, Direct Airline, Ball Foot	32
17-353	Chuck Direct Airline, Ball Foot with Clip	32
17-355	Chuck, Snap-On Clip	32
17-361	Chuck, Direct Airline, Ball Foot, 1/4" Hose Barb	33
17-362	Chuck, Direct Airline, Straight Lock On	33
17-365	Chuck, Mini Lock	32
17-369	Chuck, Direct Airline, Ball Foot	33
17-373	Chuck, Direct Airline, Grip-Tite	33
17-382	Chuck, Direct Airline, Dual Foot	33
17-383	Chuck, Direct Airline, Dual Foot	33
17-385	Chuck, Direct Airline, Dual Straight-On	33
17-392	Chuck, Direct Airline, Large Bore Clip-On	33
17-394	Chuck, Direct Airline, Large Bore	33
17-395	Chuck, Direct Airline, Straight-On Dual Locking	33
17-396	Chuck, Direct Airline, Straight-On Dual Locking	33
17-398	Chuck, Direct Airline, Straight-On Dual Locking, 12"	33
17-722	Chuck, Single Foot	32
17-726	Chuck, Grip-Tite	32
17-730	Chuck, Clip-On	32
17-732	Chuck, Straight Lock On, Flow-Through	32

Tru-Flate Part #	Description	Page
17-850	Inflator Gauge, Deluxe, Dual Foot Chuck	30
17-855	Inflator Gauge, Deluxe, Clip-On Chuck	30
17-860	Inflator Gauge, Deluxe, Straight-On Dual Foot	30
17-863	Inflator Gauge, Bayonet, Dual Foot Chuck	30
17-865	Inflator Gauge, Bayonet, Straight-On Chuck	30
17-877	Inflator Gauge, Digital, Clip-On Chuck	31
17-878	Inflator Gauge, Digital, Straight-On Dual Foot	31
18-143	Blowgun, Safety, 8 1/2" Clip-On	38
18-203	Blowgun, Standard, Lever Style	36
18-207	Blowgun, Standard, Rubber Tipped	36
18-208	Blowgun, Safety, High Volume "Venturi" Style	38
18-215	Blowgun, Safety, Rubber Tip And Safety Nozzle	38
18-217	Blowgun, Safety, 2' Extension	38
18-219	Blowgun, Safety, 4' Extension	38
18-221	Blowgun, Standard, Siphon Spray	36
18-225	Spray Cleaner, Pistol Grip	36
18-231	Blowgun, Safety, Button Style	37
18-233	Blowgun, Safety, Lever Style	37
18-237	Blowgun, Safety, Tamper-Proof	37
18-241	Deluxe Blowgun Kit	36
18-247	Palm-Style Blowgun Kit	37
18-302	Blowgun, Safety, Pocket Size, 4" Vented Extension	38
18-319	Blowgun, Safety, Pocket Size, Lever Style	38
18-325	Blowgun, Plastic, Pistol Grip	37
18-504	Radiator Filler, 3/4" Female Garden Bibb	59
18-506	Radiator Faucet, Rubber Spout, 1/4" FNPT	59
18-601	Blowgun, Safety, Adjustable Pencil Style, TF	38
18-603	Blowgun, Safety, Adjustable Pencil Style, I/M	38
18-607	Blowgun Set, TF1 HI FLO, 2Pc	34
18-608	Blowgun Set, TF3 HI FLO, 2Pc	34
18-609	Blowgun Set, TF1 HI FLO, 5 Pc	34
18-611	Blowgun Set, TF1 HI FLO, 3 Pc	34
18-612	Blowgun Set, TF3 HI FLO, 3Pc	34
18-613	Blowgun Set, TF1 HI FLO, 10Pc	34
18-615	Tip, HI FLO, Tri-Thrust	35
18-617	Chip Shield, HI FLO	35
18-621	Extensions, HI FLO, 12", 2 Pc	35
18-623	Blowgun Set, TF1 HI FLO, 7Pc	34
21-123	Fitting, Male Barb, 1/4" ID X 1/4" MNPT	40

Tru-Flate Part #	Description	Page
21-133	Fitting, Male Barb, 5/16" ID X 1/4" MNPT	40
21-143	Fitting, Male Barb, 3/8" ID X 1/4" MNPT	40
21-147	Fitting, Male Barb, 3/8" ID X 3/8" MNPT	40
21-222	Fitting, Female Barb, 1/4" ID X 1/4" FNPT	40
21-242	Fitting, Female Barb, 3/8" ID X 1/4" FNPT	40
21-323	Fitting, Female Swivel, 1/4" ID X 1/4" FNPT	40
21-423	Hose Splicer, 1/4" ID	41
21-433	Hose Splicer, 5/16" ID	41
21-467	Hose Splicer, 3/8" ID	41
21-488	Hose Splicer, 1/2" ID	41
21-505	Coupling, 1/4" MNPT X 1/4" MNPT	42
21-515	Coupling, 1/4" FNPT X 1/4" FNPT	42
21-535	Bushing, 1/4" FNPT X 3/8" MNPT	42
21-555	Drain Cock, 1/8"	42
21-557	Drain Cock, 1/4"	42
21-595	Ball-End Adapter, 1/4" MNPT x 1/4" MNPS	42
21-597	Ball-End Adapter, 1/4" MNPT w/BS x 1/4" MNPS w/BS	42
21-601	Airline Swivel, 1/4" ID Hose Barb X 1/4" MNPT	41
21-603	Airline Swivel, 3/8" ID Hose Barb X 1/4" MNPT	41
21-605	Airline Swivel, 1/4" FNPT X 1/4" MNPT	41
21-607	Fitting, Uniswivel, 1/4" MNPT x 1/4" FNPT, 360°	43
21-609	Fitting, Dual Swivel, 1/4" I/M Plug x 1/4" MNPT	43
21-707	Safety Valve, 1/4", 125 Psi	43
21-709	Safety Valve, 1/4", 150 Psi	43
22-163	Reusable Fitting, 1/4" MNPT x 11/16" OD	42
24-201	Filter/Regulator, Compact, 1/4", w/Gauge	46
24-211	Filter/Regulator, Compact, 3/8", w/Gauge	46
24-221	Filter/Regulator, Standard, 1/2", w/Gauge	46
24-222	Filter/Regulator, Standard, 1/2", w/Gauge	46
24-231	Filter/Regulator, Standard, 3/4", w/Gauge	46
24-243	Filter/Regulator, Mini, 1/4", w/Gauge	46
24-244	Filter/Regulator, Mini, 1/4", w/Gauge	46
24-301	Filter, Compact, 1/4", Manual	46
24-311	Filter, Compact, 3/8", Manual	46
24-321	Filter, Standard, 1/2", Manual	46
24-322	Filter, Standard, 1/2", Automatic	46
24-331	Filter, Standard, 3/4", Manual	46
24-343	Filter, Mini, 1/4", Manual	46

Tru-Flate Part #	Description	Page
24-351	Filter, Hi-Flow, 1", Manual, Metal Bowl	46
24-404	Regulator, Compact, 1/4", w/Gauge	47
24-414	Regulator, Compact, 3/8", w/Gauge	47
24-424	Regulator, Standard, 1/2", w/Gauge	47
24-434	Regulator, Standard, 3/4", w/Gauge	47
24-444	Regulator, Mini, 1/4", w/Gauge	47
24-454	Regulator, Hi-Flow, 1", w/Gauge	47
24-501	Lubricator, Compact, 1/4"	47
24-511	Lubricator, Compact, 3/8"	47
24-521	Lubricator, Standard, 1/2"	47
24-531	Lubricator, Standard, 3/4"	47
24-542	Lubricator, Mini, 1/4"	47
24-551	Lubricator, Hi-Flow, 1", Metal Bowl	47
24-801	Air Line Gauge, Back Mount, 0-200 Psi, 1/8" MNPT	48
24-803	Air Line Gauge, Back Mount, 0-160 Psi, 1/4" MNPT	48
24-804	Air Line Gauge, Back Mount, 0-300 Psi, 1/4" MNPT	48
24-807	Air Line Gauge, Bottom Mount, 0-160 Psi, 1/4" MNPT	48
24-811	Air Line Gauge, Bottom Mount, 0-300 Psi, 1/4" MNPT	48
24-901	Polycarbonate Bowl, Compact	49
24-902	Polycarbonate Bowl, Standard	49
24-903	Metal Bowl, Compact	49
24-910	Metal Bowl, Standard	49
24-912	Bowl Guard Kit, Standard	49
24-920	Automatic Drain Kit, Compact / Standard / Hi-Flow	49
24-930	Filter Element Kit, Hi-Flow, 40 Micron	49
24-932	Filter Element Kit, Compact, 40 Micron	49
24-939	Filter Element Kit, Standard, 40 Micron	49
24-943	Filter Element Kit, Standard, 20 SCFM	49
24-950	Mounting Bracket, Mini	49
24-950	Mounting Bracket, Mini	49
24-955	Mounting Bracket, Standard	49
24-956	Mounting Bracket, Compact	49
24-957	Mounting Bracket, Standard	49
24-958	Mounting Bracket, Hi-Flow	49
25-310	Chisel Set	59
25-311	Cut Off Discs	59
25-319	Surface Prep Kit	59
38-900	Tank Valve, 1/8" MNPT	57

Tru-Flate Part #	Description	Page
38-900-10	Tank Valve, 1/8" MNPT	57
38-906	Tank Valve, 1/8" MNPT	57
41-101	In-Line Tool Oiler	50
41-103	Desiccant Filter/Dryer, In-Line	51
41-125	3-Way Manifold, 1/4" FNPT in x 1/4" FNPT out	43
41-135	Air Flow Regulator, In-Line, w/Gauge	50
41-143	Air Tool Regulator, In-Line, At Hand, Low Pressure	50
41-145	Air Tool Regulator, In-Line, At Hand	50
41-150	Tool Filter, In-Line	51
41-155	Air Flow Regulator, w/Gauge	51
41-175	Compressor Accessory Kit, 19 Piece	58
41-225	Air Accessory Kit, 20 Piece	58
41-253	Air Accessory Kit, 15 Piece	9, 58
41-300	Hose Repair Kit	41
41-303	Hose Repair Kit	41
41-305	Hose Repair Kit	41
41-907	Air Tank Conversion Kit	57
54-516	Replacement Hose w/Fitting	57
54-517	Replacement Manifold	57
56-081	Desiccant Dryer, 1/2", 1 Quart Bowl	48

Tru-Flate Part #	Description	Page
56-082	Desiccant Dryer, Replacement Beads	48
96-610-03	Display, Air Accessories, Product Only	65
96-630	Display, Professional – Two Panel	66
96-630-02	Display, Professional – Couplers/Plug, Product Only	66
96-630-03	Display, Professional – Air Accessories, Product Only	66
96-640	Display, Air Accessories	65
96-650	Display, Tru-Flate 4 Panel Spinner	63
96-650-10	Display, Couplers/Plugs, Product Only	63
96-650-11	Display, Blow Guns/Gauges, Product Only	63
96-650-12	Display, Chucks, Fittings & Gauges, Product Only	64
96-650-13	Display, Tire Maintenance Center, Product Only	64
96-901	Coupler Identifier	13
96-902	Plug Identifier – Zinc Plated	13
97-412	Replacement, Safety Nozzle	39
99-001	Card Deck, Match Your Plug	12
99-005	Replacement, Rubber Tip, for 18-207, 18-215 or 201	39

Amflo Part #	Description	Page
40	Radiator Faucet	59
104	Chuck, Direct Airline, Ball Foot	32
105	Chuck, Angled	32
107	Chuck, Dual Foot Truck	32
108	Chuck, Direct Airline, Dual Straight-On	33
112	Hose Assembly, Straight-On Chuck, 12"	31
113	Hose Assembly, Dual Foot Chuck, 12"	31
119	Chuck, Direct Airline, Grip-Tite	33
121	Chuck, Direct Airline, 12" Dual Straight-On	33
126	Chuck, Direct Airline, Straight-On	33
127	Chuck, Straight-On	32
135	Inflator Gauge, HD, Dial, Straight-On Dual Foot	31
150	Inflator Gauge, Bayonet, Straight-On Chuck	30
153	Replacement, Dial Bar, For Amflo 150 Series	31
163	Replacement, Inflator Gauge Valve, For Amflo 150	31
200	Blowgun, Standard, Lever Style	36
201	Blowgun, Standard, Rubber Tipped	36
202	Replacement, Rubber Tip, For 18-207 or 201-100	39
209	Replacement, Venturi Tip, For 18-208 or 208	39
211	Blowgun, Standard, Flex Tip	36
221	Replacement, Siphon Spray Nozzle, For 18-221	39
226	Blowgun, Booster	37
227	Replacement, Booster Tip, For 18-221 or 228	39
235	Throttle Valve, 1/4" FNPT	56
240	Lever Valve, Two-way, 1/4" FNPT	56
344	Coupling, 1/4" MNPT x 1/4" MNPT	42
346	Coupling, 3/8" MNPT x 1/4" FNPT	42
366	Coupling, 3/8" MNPT x 3/8" MNPT	42
388	Coupling, 1/2" MNPT x 1/2" MNPT	42
398	Fitting, Male Barb, 1/4" ID x 3/8"-24 MNPT	40
399	Fitting, Male Barb, 1/8" ID x 1/8" MNPT	40
401	Fitting, Male Barb, 1/4" ID x 1/4" MNPT	40
404	Fitting, Male Barb, 1/4" ID x 1/8" MNPT	40
406	Fitting, Male Barb, 3/8" ID x 1/4" MNPT	40
408	Fitting, Male Barb, 1/2" ID x 1/4" MNPT	40
418	Reusable Fitting, 1/4" MNPT x 1/2" OD	42
419	Reusable Fitting, 1/4" MNPT x 19/32" OD	42
556	Inflating Connection, 90° Angle, 1/8" MNPT	56
582	Hose Clamp, 1/2" to 1-1/4" OD, Bulk	41

Amflo Part #	Description	Page
602	Hose Splicer, 5/16" ID	41
604	Fitting, Male Barb, 1/4" ID x 3/8" MNPT	40
608	Fitting, Male Barb, 1/2" ID x 3/8" MNPT	40
623	Reusable Fitting, 1/4" MNPT x 23/32" OD	42
705	Fitting, Bicycle Pump, 3/16" ID	57
706	Fitting, Bicycle Pump, 1/4" ID	57
711	Bleeder Valve 1/8" MNPT	57
808	Fitting, Male Barb, 1/2" ID x 1/2" MNPT	40
855	Hose Crimping Tool	60
880	Driveway Signal Bell	57
900	Coupler/Plug Key Ring, Bulk	12
900-10	Coupler/Plug Key Ring	12
1304	Ball Valve, 1/2" FNPT	56
1420	Compressor Oil – Quart	56
2112	Regulator, Tamperproof, In-Line, 90 PSI	51
2113	Regulator, Tamperproof, In-Line, 100 PSI	51
2114	Regulator, Tamperproof, In-Line, 110 PSI	51
2755	Inflating Connection, 3/16" Flare Tube, 3/8"-24	56
3063	Filter Element Kit, 3/8" Mini, 5 Micron	55
3162	Mounting Bracket, 3/8"	55
3404	3-Way Manifold, 1/4" FNPT in x 1/4" FNPT out	43
3406	3-Way Manifold, 3/8" FNPT in x 1/4" FNPT out	43
3408	3-Way Manifold, 1/2" FNPT in x 1/4" FNPT out	43
3912	Inflator Gauge, Master Air, 1/4" MNPT Fitting	31
4030	Filter, Standard, 1/2"	52
4031	Filter, Standard, 1/2", Metal Bowl	52
4032	Filter, Standard, 3/4"	52
4040	Filter, Standard, 3/4", Metal Bowl	52
4041	Filter, Hi-Flow, 3/4", Metal Bowl	52
4050	Filter, Hi-Flow, 1", Metal Bowl	52
4060	Automatic Drain	55
4068	Filter Element Kit, 1" Standard, 40 Micron	55
4070	Automatic Drain, 3/8"	55
4085	Manual Drain Repair Kit, T-Handle Type	55
4093	Filter Element Kit, 1/2" Standard, 40 Micron	55
4095	Poly Bowl, 1/2"	55
4096	Manual Drain Kit	55
4100	Regulator, Mini, 1/4"	53
4135	Regulator, Standard, 1/2"	53

Amflo Part #	Description	Page
4141	Regulator, Standard, 3/4"	53
4145	Regulator, Standard, 3/4"	53
4155	Regulator, Hi-Flow, 1"	53
4160	Mounting Bracket, Mini	55
4161	Panel Nut, Regulator, Mini	55
4165	Mounting Bracket, 1"	55
4230	Lubricator, Standard, 1/2", Poly w/Metal Guard	54
4235	Lubricator, Micro Fog, Standard, 1/2", w/Metal Guard	53
4241	Lubricator, Standard, 3/4", Metal Bowl	54
4264	Poly Bowl, Mini	55
4282	Adjustment Dome, Oil Fog Lubricators	55
4300	Filter/Regulator, Mini, 1/4"	52
4330	Filter/Regulator, Standard, 1/2", Poly w/Metal Guard	52
4331	Filter/Regulator, Standard, 1/2"	52
4340	Filter/Regulator, Standard, 3/4", Poly w/Metal Guard	52
4341	Filter/Regulator, Standard, 3/4"	52
4431	FRL Combo Unit, Standard, 1/2", Metal Bowl	54
4760	Universal Wall Bracket, 1/4" Compact Series	55
4769	Quick Clamp, 1/2" Modular Series	55
4771	Quick Clamp w/Wall Bracket, 1/2" Modular Series	55
4772	Universal Wall Bracket, 1/2" Modular Series	55
4773	Panel Mount Nut, Zinc	55
4776	Regulator Repair Kit, 1/2"	55
4778	Panel Mount Nut, Zinc	55
4780	Bowl O-Ring, Mini	55
4782	Bowl O-Ring, 3/8"	55
4783	Bowl O-Ring, 1/2"	55
6116	Inflating Connection, 70° Angle, 1/8" FNPT	56
4-12	1/4" x 12' Nylon Recoil Hose	7
6-25	3/8" x 25' Nylon Recoil Hose	7
200E6	Extension, Standard Blowgun, 6"	39
204E12	Extension, 12" Safety	39
100D	Inflator Gauge, HD, Bayonet, Straight-On Chuck	31
100LW	Inflator Gauge, HD, Body Only	31
10-11K	Heavy Duty Truck Air Seat Blow Gun Kit	9
1012-15	Dial Gauge, Bottom Mount, 0-15 PSI, 1/4" MNPT	54
1012-160	Dial Gauge, Bottom Mount, 0-15 PSI, 1/4" MNPT	54
101D	Inflator Gauge, HD, Bayonet, Dual Foot Chuck	31
101HD	Inflator Gauge, HD, Bayonet, Epoxy Dual Foot Chuck	31

Amflo Part #	Description	Page
104CA	Chuck Direct Airline, Ball Foot with Clip	32
106-100	Chuck, Straight-On w/ 1/4" Barb	32
1101-160	Dial Gauge, Back Mount, 0-60 PSI, 1/8" MNPT	54
1101-60	Dial Gauge, Back Mount, 0-60 PSI, 1/8" MNPT	54
1112-160	Dial Gauge, Back Mount, 0-160 PSI, 1/4" MNPT	54
1112-300	Dial Gauge, Back Mount, 0-300 PSI, 1/4" MNPT	54
118D	Chuck, Direct Airline, Dual Foot Safety Lock-On	33
12-100E	1/4" x 100' Poly Air Hose	6
1220-1	Air Tool Oil - Pint	56
1220-4	Air Tool Oil - 4 oz.	56
1220-8	Air Tool Oil - Gallon	56
12-25E	1/4" x 25' Poly Air Hose	6
12-50E	1/4" x 50' Poly Air Hose	6
13-100AE	3/8" x 100' Poly Air Hose	6
13-50AE	3/8" x 50' Poly Air Hose	6
135DG	Replacement, Dial Gauge, For Amflo 135	31
14-100	1/4" x 100' Poly Air Hose	6
14-50	1/4" x 50' Poly Air Hose	6
14-50K	1/4" x 50' Air Hose, w/ Kit	9
1468L-6	Tank Valve, 1/4" NPT, , Bulk	57
1498L-6	Tank Valve, 1/4" NPT	57
150-50	Inflator Gauge, Bayonet, Straight-On Chuck, Bulk	30
150E-RET	Inflator Gauge, Bayonet, Straight-On Chuck	30
150LW-50	Inflator Gauge, Body Only. Bulk	31
200-100	Blowgun, Standard, Lever Style, Bulk	36
200F8	Extension, 8" Flexible Metal	39
200NT-1	Replacement, 2-3/4" Blowgun Needle Tip	39
200NT-2	Replacement, 2-1/2" Blowgun Needle Tip	39
200NT-4	Replacement, 1-1/8" Blowgun Needle Tip	39
204-30	Blowgun, Safety, Lever Style	37
204-30A	Blowgun, Safety, Tamper-Proof	37
205ATD	Blowgun, HD, Angled Rubber Tip	37
205D	Blowgun, Heavy Duty	37
211-100	Blowgun, Standard, Flex Tip, Bulk	36
240-100	Lever Valve, Two-way, 1/4" FNPT, Bulk	56
24-25E-RET	1/4" x 25' Poly Recoil Hose	7
24-50E-RET	1/4" x 50' Poly Recoil Hose	7
25-24-RET	1/4 X 24 PVC Lead-In Hose	8
25L-24BD	1/4" x 24" Rubber Lead-In Hose	8

Amflo Part #	Description	Page
25L-60BD	1/4" x 60" Rubber Lead-In Hose	8
270A	Mist Coolant Unit	59
344R	Swivel Fitting, 1/4" MNPT x 1/4" FNPT	43
344T	Fitting, Female Tee, 1/4" FNPT	43
344U	Fitting, Uniswivel, 1/4" MNPT x 1/4" FNPT, 360°	43
344X	Fitting, Female Cross, 1/4" FNPT	43
346F	Bushing, 3/8" MNPT x 1/4" FNPT	42
348F	Bushing, 1/2" MNPT x 1/4" FNPT	42
366R	Swivel Fitting, 3/8" MNPT x 3/8" FNPT	43
368F	Bushing, 1/2" MNPT x 3/8" FNPT	42
37L-30B-RET	3/8" x 30" Rubber Lead-In Hose	8
3910S	Inflator Gauge, Master Air, Standard Bore	31
4010A-99	Filter, Compact, 1/4"	52
4011A-99	Filter, Compact, 1/4", Metal Bowl	52
401S	Swivel Fitting, 1/4" MNPT	40
40-205RK	Heavy Duty Blowgun/ Inflator Repair Kit	39
4020A-99	Filter, Compact, 3/8"	52
4021A-99	Filter, Compact, 3/8", Metal Bowl	52
406-100	Fitting, Male Barb, 3/8" ID x 1/4" MNPT, Bulk	40
406L	Fitting, Male Lock-On, 3/8" ID x 1/4" MNPT	40
406S	Fitting, Male Swivel, Hi Volume, 3/8" ID x 1/4" MNPT	40
4071A-99	Mounting Bracket, 3/8"	55
4074A-99	Poly Bowl, 3/8"	55
40R	Radiator Faucet, Rubber Spout, 1/4" FNPT	59
40R-100	Radiator Faucet, Rubber Spout, 1/4" FNPT, Bulk	59
40RD	Radiator Faucet, Rubber Spout, 1/4" FNPT	59
4100D	Regulator, Mini, 1/4"	53
4115A-99	Regulator, Compact, 1/4"	53
4210A-99	Lubricator, Compact, 1/4"	54
4211A-99	Lubricator, Compact, 1/4", Metal Bowl	54
4220A-99	Lubricator, Compact, 3/8"	54
4-25E-RET	1/4" 25' Nylon Recoil Hose	7
4265A-99	Poly Bowl, 3/8", For Lubricator	55
4270A-99	Metal Bowl, 3/8", For Lubricator	55
4310A-99	Filter/Regulator, Standard, 1/4"	52
4320A-99	Filter/Regulator, Standard, 3/8"	52
43W	Water Nozzle	59
446SL	Fitting, Male Lock-On Ball Swivel, 3/8" ID x 1/4" MNPT	40
4-50-RET	1/4" 50' Nylon Recoil Hose	7

Amflo Part #	Description	Page
494-100	Signal Bell Tubing	8
494-500	Signal Bell Tubing, Bulk	8
5029A-50	.900" I.D. Ferrule	60
503HR-RET	Manual Hose Reel, Knock-Down	11
507HR-RET	3/8" x 25' Retractable Hose Reel, Hybrid	10
508HR-RET	3/8" x 50' Retractable Hose Reel, Hybrid	10
512-25E	1/4" x 25' Red Rubber Hose	5
512-50E	1/4" x 50' Red Rubber Hose	5
514-500	3/8" x 500' Rubber Hose, Bulk	8
518HR-RET	1/2" x 50' Retractable Hose Reel, Hybrid	10
538HR-RET	1/2" x 50' Enclosed Retractable Hose Reel, Hybrid	10
541HR-RET	3/8" x 30' Enclosed Retractable Hose Reel, Hybrid	10
543HR-RET	3/8" x 50' Enclosed Retractable Hose Reel, Hybrid	10
545HR-RET	Manual Hose Reel, Polyurethane	11
546HR-RET	3/8" x 65' Enclosed Retractable Hose Reel, Hybrid	10
552-25AE	3/8" x 25' Red Rubber Hose	5
552-50AE	3/8" x 50' Red Rubber Hose	5
552-50AK	3/8" x 50' Red Rubber Hose w/Blow Gun Kit	9
552-50AK-5	3/8" x 50' Red Rubber Hose w/Blow Gun Kit	9
554-100A	3/8" x 100' PVC Air Hose	6
554-50A	3/8" x 50' PVC Air Hose	6
556-50A	3/8" x 50' Black Rubber Hose	5
572-100	1/4" x 100' Hybrid Air Hose	4
572-25	1/4" x 25' Hybrid Air Hose	4
572-50	1/4" x 50' Hybrid Air Hose	4
573-100A	1/2" x 100' Hybrid Air Hose	4
573-25A	1/2" x 25' Hybrid Air Hose	4
573-50A	1/2" x 50' Hybrid Air Hose	4
574-50GH	3/8" x 50' PVC Hose HD Truck Inflator Kit	9
575-100A	3/8" x 100' Hybrid Air Hose	4
575-25A	3/8" x 25' Hybrid Air Hose	4
575-35A	3/8" x 35' Hybrid Air Hose	4
575-50A	3/8" x 50' Hybrid Air Hose	4
575-50AGH	3/8" x 50' Air Hose, Ultra Air, Glad Hand	9
576-100A	3/8" x 100' PVC Air Hose	6
576-25A	3/8" x 25' PVC Air Hose	6
576-50A	3/8" x 50' PVC Air Hose	6
576-50AK	3/8" x 50' Hose, w/ Kit	9
57L-30B-RET	30" Hybrid Lead-In Hose	8

Amflo Part #	Description	Page
57L-48B-RET	48" Hybrid Lead-In Hose	8
57L-72B-RET	72" Hybrid Lead-In Hose	8
580-50ACK	HI-FLO Conversion Kit	9, 27
580-100	Hose Clamp, 1/4" to 5/8" OD, Bulk	41
581-100	Hose Clamp, 3/8" to 7/8" OD, Bulk	41
588HR-RET	3/8" x 50' Enclosed Retractable Hose Reel, Hybrid	10
590CR-RET	40' Enclosed Retractable Cord Reel, 12AWG	11
591CR-RET	50' Enclosed Retractable Cord Reel, 14AWG	11
603-2N1-RET	2-in-1 Retractable Hose Reel, Hybrid/Electric	11
645L-6	Tank Valve, 1/8" NPT, Bulk	57
700-100	Tank Valve, 1/8" MNPT, Bulk	57
701-2	Tank Valve, 1/4" MNPT	57
701-2-100	Tank Valve, 1/4" MNPT, Bulk	57
701-42	Tank Valve, 1/4" ID Hose Barb	57
705-100	Fitting, Bicycle Pump, 3/16" ID, Bulk	57
706-100	Fitting, Bicycle Pump, 1/4" ID, Bulk	57
710-100	Bleeder Valve, .310-32 Thread	57
711-100	Bleeder Valve, 1/8" MNPT, Bulk	57
7242A-50	.937" I.D. Ferrule	60
7321-50	.478" I.D. Ferrule	60
7322-50	.500" I.D. Ferrule	60
7323-50	.525" I.D. Ferrule	60
7325-50	.562" I.D. Ferrule	60
7326-50	.593" I.D. Ferrule	60
7327-50	.625" I.D. Ferrule	60
7328-50	.656" I.D. Ferrule	60
7329-50	.687" I.D. Ferrule	60
7330-50	.718" I.D. Ferrule	60
7331-50	.750" I.D. Ferrule	60
7332-50	.781" I.D. Ferrule	60
7333-50	.812" I.D. Ferrule	60
7334-50	.825" I.D. Ferrule	60
7335-50	.850" I.D. Ferrule	60
856-1	5/8" Die Block for 855 Hose Crimping Tool	60
856-8	3/4" Die Block for 855 Hose Crimping Tool	60
856-9	13/16" Die Block for 855 Hose Crimping Tool	60
859W	Chuck Washer, For Straight-On and Dual Foot Chucks	33
880N	Tubing Anchor, For Driveway Signal Bell	57
9166L-8	Tank Valve, 1/8" NPT	57

Amflo Part #	Description	Page
C1	Coupler, 1/4" TF, 1/4" MNPT	21
C10	Coupler, 1/2" TF & I/M, 1/2" FNPT	19,23
C10-23	Coupler, 1/2" I/M, 3/8" FNPT	19,23
C1-03	Coupler, 1/4" TF, 3/8" MNPT	21
C10-45	Coupler, 1/2" I/M Barb, 1/2" ID	19,23
C10-50	Coupler, 1/2" I/M, 1/2" FNPT, Bulk	19,23
C1-100	Coupler, 1/4" TF, 1/4" MNPT, Bulk	21
C1B-100	Coupler, 1/4" TF, 1/4" MNPT, Brass, Bulk	21
C2	Coupler, 1/4" TF, 1/4" FNPT	21
C20	Coupler, 1/4" I/M, 1/4" FNPT	17
C20-100	Coupler, 1/4" I/M, 1/4" FNPT, Bulk	17
C20-23	Coupler, 1/4" I/M, 3/8" FNPT	17
C20-23-100	Coupler, 1/4" I/M, 3/8" FNPT, Bulk	17
C20-23B	Coupler, 1/4" I/M, 3/8" FNPT, Brass	17
C20-42	Coupler, 1/4" I/M Barb, 1/4" ID	17
C20-42-100	Coupler, 1/4" I/M Barb, 1/4" ID, Bulk	17
C20-42B	Coupler, 1/4" I/M Barb, 1/4" ID, Brass	17
C20-42L	Coupler, 1/4" I/M Lock-On, 1/4" ID	17
C20-42LBP-100	Coupler, 1/4" I/M Lock-On, 1/4" ID, Brass, Bulk	17
C20-44	Coupler, 1/4" I/M Barb, 3/8" ID	17
C20-44-100	Coupler, 1/4" I/M Barb, 3/8" ID, Bulk	17
C20-44B	Coupler, 1/4" I/M Barb, 3/8" ID, Brass	17
C20-44L	Coupler, 1/4" I/M Lock-On, 3/8" ID	17
C20-44LBP-100	Coupler, 1/4" I/M Lock-On, 3/8" ID, Brass, Bulk	17
C20B	Coupler, 1/4" I/M, 1/4" FNPT, Brass	17
C20B-100	Coupler, 1/4" I/M, 1/4" FNPT, Brass, Bulk	17
C21	Coupler, 1/4" I/M, 1/4" MNPT	17
C2-100	Coupler, 1/4" TF, 1/4" FNPT, Bulk	21
C21-03	Coupler, 1/4" I/M, 3/8" MNPT	17
C21-03B	Coupler, 1/4" I/M, 3/8" MNPT, Brass	17
C21-03B-100	Coupler, 1/4" I/M, 3/8" MNPT, Brass, Bulk	17
C21-100	Coupler, 1/4" I/M X 1/4" MNPT, Bulk	17
C21B	Coupler, Brass, 1/4" I/M, 1/4" MNPT	17
C21B-100	Coupler, Brass, 1/4" I/M, 1/4" MNPT, Bulk	17
C2-23	Coupler, 1/4" TF, 3/8" FNPT	21
C2-42	Coupler, 1/4" TF Barb, 1/4" ID	21
C2-42L	Coupler, 1/4" TF, 1/4" Barb	21
C2-44	Coupler, 1/4" TF Barb, 3/8" ID	21
C2-44L	Coupler, 1/4" TF Lock-On, 3/8" ID	21

Amflo Part #	Description	Page
C25	Coupler, 3/8" I/M, 3/8" MNPT	19
C25-02	Coupler, 3/8" I/M, 1/4" MNPT	19
C25-50	Coupler, 3/8" I/M, 3/8" MNPT, Bulk	19
C26	Coupler, 3/8" I/M, 3/8" FNPT	19
C26-22	Coupler, 3/8" I/M, 1/4" FNPT	19
C26-24	Coupler, 3/8" I/M, 1/2" FNPT	19
C26-44	Coupler, 3/8" I/M Barb, 3/8" ID	19
C26-44L	Coupler, 3/8" I/M Lock-On, 3/8" ID	19
C26-45	Coupler, 3/8" I/M Barb, 1/2" ID	19
C26-50	Coupler, 3/8" I/M, 3/8" FNPT, Bulk	19
C28-100	Coupler, 1/4" Linc, 1/4" FNPT, Bulk	26
C2B	Coupler, 1/4" TF, 1/4" FNPT, Brass	21
C2B-100	Coupler, 1/4" TF, 1/4" FNPT, Brass, Bulk	21
C2R	Coupler, 1/4" Recapper, 1/4" FNPT	23
C30	Coupler, 1/4" Diamond U, 1/4" FNPT	28
C31	Coupler, 1/4" Diamond U, 1/4" MNPT	28
C35	Coupler, 3/8" ARO, 3/8" MNPT	25
C36	Coupler, 3/8" ARO, 3/8" FNPT	25
C37	Coupler, 1/4" ARO, 1/4" MNPT	25
C37-03	Coupler, 1/4" ARO, 3/8" MNPT	25
C37-100	Coupler, 1/4" ARO, 1/4" MNPT, Bulk	25
C38	Coupler, 1/4" ARO, 1/4" FNPT	25
C38-100	Coupler, 1/4" ARO, 1/4" FNPT, Bulk	25
C38-23	Coupler, 1/4" ARO, 3/8" FNPT	25
C38-42	Coupler, 1/4" ARO Barb, 1/4" ID	25
C38-44	Coupler, 1/4" ARO Barb, 3/8" ID	25
C46	Push Coupler, 1/4" ARO, 1/4" FNPT	25
C5	Coupler, 3/8" TF, 3/8" MNPT	22
C5-04	Coupler, 3/8" TF, 1/2" MNPT	22
C5-50	Coupler, 3/8" TF, 3/8" MNPT, Bulk	22
C6	Coupler, 3/8" TF, 3/8" FNPT	22
C60C	Coupler, Universal, 1/4" FNPT, Composite	29
C6-24	Coupler, 3/8" TF, 1/2" FNPT	22
C6-44	Coupler, 3/8" TF Barb, 3/8" ID	22
C6-45	Coupler, 3/8" TF Barb, 1/2" ID	22
C6-50	Coupler, 3/8" TF, 3/8" FNPT, Bulk	22
C7	Coupler, 3/8" TF, 1/4" MNPT	22
C7-50	Coupler, 3/8" TF, 1/4" MNPT, Bulk	22
C8	Coupler, 3/8" TF, 1/4" FNPT	22

Amflo Part #	Description	Page
C8-50	Coupler, 3/8" TF, 1/4" FNPT	22
C9	Coupler, 1/2" I/M, 1/2" MNPT	19,23
C90	Coupler, 1/4" HI FLO, 1/4" FNPT, Brass	27
C90-100	Coupler, 1/4" HI FLO, 1/4" FNPT, Brass, Bulk	27
C9-03	Coupler, 1/2" I/M, 3/8" MNPT	19,23
C91	Coupler, 1/4" HI FLO, 1/4" MNPT, Brass	27
C91-100	Coupler, 1/4" HI FLO, 1/4" MNPT, Brass	27
C9-50	Coupler, 1/2" I/M, 1/2" MNPT, Bulk	19,23
CP1	Plug, 1/4" TF, 1/4" MNPT	20
CP10	Plug, 1/2" TF, 1/2" FNPT	23
CP10-50	Plug, 1/2" TF, 1/2" FNPT	23
CP10-23	Plug, 1/2" TF, 3/8" FNPT	23
CP1-03	Plug, 1/4" TF, 3/8" MNPT	20
CP1-100	Plug, 1/4" TF, 1/4" MNPT, Bulk	20
CP12	Plug, 1/4" Recapper, .302-32 FNPT	23
CP1-302	Plug, 1/4" TF, .302-32 Male	20
CP1-42	Plug, 1/4" TF Barb, 1/4" ID	20
CP1-42L	Plug, 1/4" TF Lock-On, 1/4" ID	20
CP1-44	Plug, 1/4" TF Barb, 3/8" ID	20
CP1-44L	Plug, 1/4" TF Lock-On, 3/8" ID	20
CP17	Plug, 1/2" I/M, 3/8" MNPT	19
CP17-03	Plug, 1/2" I/M, 3/8" MNPT	19
CP17-45	Plug, 1/2" I/M Barb, 1/2" ID	19
CP18	Plug, 1/2" I/M, 3/8" FNPT	19
CP18-23	Plug, 1/2" I/M, 3/8" FNPT	19
CP1B	Plug, 1/4" TF, 1/4" MNPT, Brass	20
CP2	Plug, 1/4" TF, 1/4" FNPT	20
CP20	Plug, 1/4" I/M, 1/4" FNPT	16
CP20-100	Plug, 1/4" I/M, 1/4" FNPT, Bulk	16
CP20-23	Plug, 1/4" I/M, 3/8" FNPT, Bulk	16
CP20B	Plug, 1/4" I/M, 1/4" FNPT, Brass	16
CP20B-100	Plug, 1/4" I/M, 1/4" FNPT, Brass, Bulk	16
CP21	Plug, 1/4" I/M, 1/4" MNPT	16
CP2-100	Plug, 1/4" TF, 1/4" FNPT, Bulk	20
CP21-03	Plug, 1/4" I/M, 3/8" MNPT	16
CP21-100	Plug, 1/4" I/M, 1/4" MNPT, Bulk	16
CP21-42	Plug, 1/4" I/M Barb, 1/4" ID	16
CP21-42-100	Plug, 1/4" I/M Barb, 1/4" ID, Bulk	16
CP21-42L	Plug, 1/4" I/M Lock-On, 1/4" ID	16

Amflo Part #	Description	Page
CP21-44	Plug, 1/4" I/M Barb, 3/8" ID	16
CP21-44-100	Plug, 1/4" I/M Barb, 3/8" ID, Bulk	16
CP21-44L	Plug, 1/4" I/M Lock-On, 3/8" ID	16
CP21B	Plug, 1/4" I/M, 1/4" MNPT, Brass	16
CP21B-100	Plug, 1/4" I/M, 1/4" MNPT, Brass, Bulk	16
CP22	Plug, 1/4" I/M, .302-32 FNPT	16
CP2-23	Plug, 1/4" TF, 3/8" FNPT	20
CP25	Plug, 3/8" I/M, 3/8" MNPT	18
CP25-02	Plug, 3/8" I/M, 1/4" MNPT	18
CP25-02-100	Plug, 3/8" I/M, 1/4" MNPT, Bulk	18
CP25-04	Plug, 3/8" I/M, 1/2" MNPT, Bulk	18
CP25-44	Plug, 3/8" I/M Barb, 3/8" ID	18
CP25-44L	Plug, 3/8" I/M Lock-On, 3/8" ID	18
CP25-45	Plug, 3/8" I/M Barb, 1/2" ID	18
CP25-50	Plug, 3/8" I/M, 3/8" MNPT, Bulk	18
CP26	Plug, 3/8" I/M, 3/8" FNPT	18
CP26-22	Plug, 3/8" I/M, 1/4" FNPT	18
CP26-24	Plug, 3/8" I/M, 1/2" FNPT	18
CP27	Plug, 1/4" Linc, 1/4" MNPT	26
CP27-100	Plug, 1/4" Linc, 1/4" MNPT, Bulk	26
CP28	Plug, 1/4" Linc, 1/4" FNPT	26
CP28-100	Plug, 1/4" Linc, 1/4" FNPT	26
CP2B	Plug, 1/4" TF, 1/4" FNPT, Brass	20
CP33	Plug, 1/4" Diamond U, 1/4" MNPT	28
CP34	Plug, 1/4" Diamond U, 1/4" MNPT	28
CP35	Plug, 3/8" ARO, 3/8" MNPT	25
CP36	Plug, 3/8" ARO, 3/8" FNPT	25
CP37	Plug, 1/4" ARO, 1/4" MNPT	24
CP37-03	Plug, 1/4" ARO, 3/8" MNPT	24
CP37-100	Plug, 1/4" ARO, 1/4" MNPT, Bulk	24
CP37-42	Plug, 1/4" ARO Barb, 1/4" ID	24
CP37-44L	Plug, 1/4" ARO Lock-On, 3/8" ID	24

Amflo Part #	Description	Page
CP38	Plug, 1/4" ARO, 1/4" FNPT	24
CP38-100	Plug, 1/4" ARO, 1/4" FNPT, Bulk	24
CP38-23	Plug, 1/4" ARO, 3/8" FNPT	24
CP5	Plug, 3/8" TF, 3/8" MNPT	22
CP5-04	Plug, 3/8" TF, 1/2" MNPT	22
CP5-44	Plug, 3/8" TF Barb, 3/8" ID	22
CP5-44L	Plug, 3/8" TF Lock-On, 3/8" ID	22
CP5-50	Plug, 3/8" TF, 3/8" MNPT, Bulk	22
CP6	Plug, 3/8" TF, 3/8" FNPT	22
CP6-24	Plug, 3/8" TF, 3/8" FNPT	22
CP7	Plug, 3/8" TF, 1/4" MNPT	22
CP7-50	Plug, 3/8" TF, 1/4" MNPT	22
CP8	Plug, 3/8" TF, 1/4" FNPT	22
CP8-50	Plug, 3/8" TF, 1/4" FNPT, Bulk	22
CP9	Plug, 1/2" TF, 1/2" MNPT	23
CP90	Plug, 1/4" HI FLO, 1/4" FNPT	26
CP90-100	Plug, 1/4" HI FLO, 1/4" FNPT, Bulk	26
CP9-03	Plug, 1/2" TF, 3/8" MNPT	23
CP91	Plug, 1/4" HI FLO, 1/4" MNPT	26
CP91-100	Plug, 1/4" HI FLO, 1/4" MNPT, Bulk	26
CPST17B	Plug, Straight-Thru, 1/4" FNPT, Brass	28
CPST4B	Plug, Straight-Thru 1/4" FNPT, Brass	28
CPST5B	Plug, Straight-Thru, 3/8" MNPT, Brass	28
CPST6B	Plug, Straight-Thru 3/8" FNPT, Brass	28
CPST8B	Plug, Straight-Thru, 1/2" FNPT, Brass	28
GST17B	Coupler, Straight-Thru, 1/4" FNPT, Brass	28
CST4B	Coupler, Straight-Thru, 1/4" FNPT, Brass	28
CST6B	Coupler, Straight-Thru, 3/8" FNPT, Brass	28
CST8B	Coupler, Straight-Thru, 1/2" FNPT, Brass	28

TRU-FLATE® TIRE REPAIR CATALOG

TRU-FLATE®

*Don't Forget To Check Out
Our TRU-FLATE® Branded
Line Of Tire Repair
Products*



SEALANTS



INFLATORS



TIRE GAUGES



TIRE REPAIR PRODUCTS



PLEWS & EDELMA

AMERICAN INNOVATION SINCE 1909®

Amflö

AMFLO

PNEUMATIC HOSES & REELS
AIR LINE ACCESSORIES

EDELMA

EDELMA

AUTOMOTIVE FITTINGS
BRAKE LINES
POWER STEERING HOSE & REPAIR KITS

LübriMatic

LUBRIMATIC

GREASES, OILS & SPRAY LUBRICANTS
LUBRICATION EQUIPMENT

TRÜ-FLATE

TRU-FLATE

AIR LINE ACCESSORIES
INFLATORS
TIRE REPAIR & GAUGES
SEALANTS

UltraLUBE

ULTRALUBE

BIOBASED LUBRICANTS

Plews & Edelmann
1550 Franklin Grove Road,
Dixon, IL 61021 USA
Telephone: 800-770-4639 • Fax: 815-673-7019
www.plews-edelmann.com

©2019 Plews & Edelmann • Printed in the USA